

Valiant TMS



Company / customer	Volvo Trucks NA	
Project description	P6700 Underbody Floor Skin - Cell 2V03	
drawing number	22-16151	
Commission	Volvo Trucks North America	
Manufacturer (company)	Valiant TMS	
Project name	=2V03&MFS-PNEU	
Type	P6700 Underbody Floor Skin - Cell 2V03	
Created on	1/24/2018	
Edit date	11/16/2022	by (short name) KMAFFRE
		Number of pages 176

		Date	9/6/2022	Volvo Trucks North America		Valiant TMS	Title page / cover sheet	Drawing name:	=	
		Ed.	MKLEPADLO						=2V03&MFS-PNEU	+
		Appr		P6700 Underbody Floor Skin - Cell 2V03				Document type:		Project nr:
Modification	Date	Name	Original	Replacement of	Replaced by	Scale 1:1		MAA		22-16151
									Page	1
										176

Table of contents

Column X: An automatically generated page was edited

F06_001-Copy

Page	Page description	supplementary page field	Date	Edited by	X
&MFS=V1GL12UQ51KF1+V1GL12UQ51/11	AIR SUPPLY		9/30/2022	MKLEPADLO	
&MFS=V1GL12UQ51UQ1+V1GL12UQ51/1	Pallet Stop Station #1 Load		10/31/2022	KMAFFRE	
&MFS=V1GL12UQ51UQ2+V1GL12UQ51/1	Pallet Stop Station #2 Mid-Stop		10/31/2022	KMAFFRE	
&MFS=V1GL12UQ51UQ6+V1GL12UQ51/1	Pallet Stop Station #6 Pre-Load		10/31/2022	KMAFFRE	
&MFS=V1GL12UQ51UQx+V1GL12UQ51/1	Spare		10/31/2022	KMAFFRE	
&MFS=V1GM1+KH1/1	Incoming air supply (Lift Assist)		10/31/2022	KMAFFRE	
&MFS=V1GM2+KH1/1	Incoming air supply (Lift Assist)		10/31/2022	KMAFFRE	
&MFS=V1PF1+KH1/1	Incoming air supply (Fixture)		10/31/2022	KMAFFRE	
&MFS=V1PF1KF1+V1PF1/5	AIR SUPPLY CONFIGURATION		10/31/2022	KMAFFRE	
&MFS=V1PF1KF1+V1PF1/11	AIR SUPPLY		10/31/2022	KMAFFRE	
&MFS=V1PF1UQ1+V1PF1/1	Clamp		10/31/2022	KMAFFRE	
&MFS=V1PF1UQ2+V1PF1/1	Spare		10/31/2022	KMAFFRE	
&MFS=V1UQ51+KH1/1	Incoming air supply (Fixture)		10/31/2022	KMAFFRE	
&MFS=V1UQ51KF1+V1UQ51/5	AIR SUPPLY CONFIGURATION		10/17/2022	MKLEPADLO	
&MFS=V1UQ51KF1+V1UQ51/11	AIR SUPPLY		9/30/2022	MKLEPADLO	
&MFS=V1UQ51KF2+V1UQ51/5	AIR SUPPLY CONFIGURATION		9/30/2022	MKLEPADLO	
&MFS=V1UQ51KF2+V1UQ51/11	AIR SUPPLY		9/30/2022	MKLEPADLO	
&MFS=V1UQ51UQ1+V1UQ51/1	Common Shot Pin		10/31/2022	KMAFFRE	
&MFS=V1UQ51UQ2+V1UQ51/1	L150 Model Shot Pin		10/31/2022	KMAFFRE	
&MFS=V1UQ51UQ3+V1UQ51/1	L230 Model Shot Pin		10/31/2022	KMAFFRE	
&MFS=V1UQ51UQ4+V1UQ51/1	L290 Model Shot Pin		10/31/2022	KMAFFRE	
&MFS=V1UQ51UQ5+V1UQ51/1	L320 Model Shot Pin		10/31/2022	KMAFFRE	
&MFS=V1UQ51UQ6+V1UQ51/1	Common Clamps		10/31/2022	KMAFFRE	
&MFS=V1UQ51UQ7+V1UQ51/1	L150 Model Clamps		10/31/2022	KMAFFRE	
&MFS=V1UQ51UQ8+V1UQ51/1	L230/290/320 Model Clamps		10/31/2022	KMAFFRE	
&MFS=V1UQ51UQ9+V1UQ51/1	L290/320 Model Clamps		10/31/2022	KMAFFRE	
&MFS=V1UQ51UQ10+V1UQ51/1	L320 Model Clamps		10/31/2022	KMAFFRE	
&MFS=V1UQ51UQ11+V1UQ51/1	L230 Model Clamp		10/31/2022	KMAFFRE	
&MFS=V1UQ51UQ12+V1UQ51/1	L290 Model Clamp		10/31/2022	KMAFFRE	
&MFS=V1WR1+KH1/1	Incoming air supply (Turn Table)		10/31/2022	KMAFFRE	
&MFS=V1WR1UQ51KF1+V1WR1UQ51/5	AIR SUPPLY CONFIGURATION		9/30/2022	MKLEPADLO	
&MFS=V1WR1UQ51KF1+V1WR1UQ51/11	AIR SUPPLY		9/30/2022	MKLEPADLO	
&MFS=V1WR1UQ51KF2+V1WR1UQ51/5	AIR SUPPLY CONFIGURATION		9/30/2022	MKLEPADLO	

1.a

1.c

		Date	10/31/2022	Volvo Trucks North America			Valiant TMS	Table of contents	Drawing name: = 2V03&MFS-PNEU		=
		Ed.	KMAFFRE	P6700 Underbody Floor Skin - Cell 2V03						Document type: MAB	
Modification	Date	Name	Original	Replacement of	Replaced by		Scale 1:1		Project nr: 22-16151	Page	1.b 176

Table of contents

Column X: An automatically generated page was edited

F06_001-Copy

Page	Page description	supplementary page field	Date	Edited by	X
&MFS=V1WR1UQ51KF2+V1WR1UQ51/11	AIR SUPPLY		9/30/2022	MKLEPADLO	
&MFS=V1WR1UQ51UQ1+V1WR1UQ51/1	Clamps 1		9/30/2022	MKLEPADLO	
&MFS=V1WR1UQ51UQ2+V1WR1UQ51/1	Clamps 2		9/30/2022	MKLEPADLO	
&MFS=V1WR1UQ51UQ3+V1WR1UQ51/1	Clamps 3		9/30/2022	MKLEPADLO	
&MFS=V1WR1UQ51UQ4+V1WR1UQ51/1	Clamps 4		9/30/2022	MKLEPADLO	
&MFS=V1WR1UQ51UQ5+V1WR1UQ51/1	Swivel Unit Locks		10/31/2022	KMAFFRE	
&MFS=V1WR1UQ51UQ6+V1WR1UQ51/1	Swivel Units		10/31/2022	KMAFFRE	
&MFS=V1WR1UQ51UQ7+V1WR1UQ51/1	Shot Pins 1		9/30/2022	MKLEPADLO	
&MFS=V1WR1UQ51UQ8+V1WR1UQ51/1	Shot Pins 2		9/30/2022	MKLEPADLO	
&MFS=V1WR1UQ51UQ9+V1WR1UQ51/1	Clamps 5		9/30/2022	MKLEPADLO	
&MFS=V1WR1UQ51UQ10+V1WR1UQ51/1	Spare		9/30/2022	MKLEPADLO	
&MFS=V1WR1UQ51UQ11+V1WR1UQ51/1	Spare		9/30/2022	MKLEPADLO	
&MFS=V1WR1UQ52KF1+V1WR1UQ52/5	AIR SUPPLY CONFIGURATION		9/30/2022	MKLEPADLO	
&MFS=V1WR1UQ52KF1+V1WR1UQ52/11	AIR SUPPLY		9/30/2022	MKLEPADLO	
&MFS=V1WR1UQ52KF2+V1WR1UQ52/5	AIR SUPPLY CONFIGURATION		11/16/2022	KMAFFRE	
&MFS=V1WR1UQ52KF2+V1WR1UQ52/11	AIR SUPPLY		11/16/2022	KMAFFRE	
&MFS=V1WR1UQ52UQ1+V1WR1UQ52/1	Common Shot Pins		9/30/2022	MKLEPADLO	
&MFS=V1WR1UQ52UQ2+V1WR1UQ52/1	Common Clamps 1		9/30/2022	MKLEPADLO	
&MFS=V1WR1UQ52UQ3+V1WR1UQ52/1	Common Clamps 2		9/30/2022	MKLEPADLO	
&MFS=V1WR1UQ52UQ4+V1WR1UQ52/1	L150 Model Clamps 1		9/30/2022	MKLEPADLO	
&MFS=V1WR1UQ52UQ5+V1WR1UQ52/1	L150 Model Clamps 2		11/4/2022	KMAFFRE	
&MFS=V1WR1UQ52UQ6+V1WR1UQ52/1	L230 Model Shot Pins		9/30/2022	MKLEPADLO	
&MFS=V1WR1UQ52UQ7+V1WR1UQ52/1	L230 Model Clamps 1		11/16/2022	KMAFFRE	
&MFS=V1WR1UQ52UQ8+V1WR1UQ52/1	L230/290/320 Model Clamps		9/30/2022	MKLEPADLO	
&MFS=V1WR1UQ52UQ9+V1WR1UQ52/1	L290 Model Shot Pins		9/30/2022	MKLEPADLO	
&MFS=V1WR1UQ52UQ10+V1WR1UQ52/1	L290/320 Model Clamps 1		9/30/2022	MKLEPADLO	
&MFS=V1WR1UQ52UQ11+V1WR1UQ52/1	L290 Model Clamps 1		9/30/2022	MKLEPADLO	
&MFS=V1WR1UQ52UQ12+V1WR1UQ52/1	L290 Model Clamp 2		9/30/2022	MKLEPADLO	
&MFS=V1WR1UQ52UQ13+V1WR1UQ52/1	L290/320 Model Clamps 2		9/30/2022	MKLEPADLO	
&MFS=V1WR1UQ52UQ14+V1WR1UQ52/1	L290/320 Model Clamps 3		9/30/2022	MKLEPADLO	
&MFS=V1WR1UQ52UQ15+V1WR1UQ52/1	L290/320 Model Position Lock		9/30/2022	MKLEPADLO	
&MFS=V1WR1UQ52UQ16+V1WR1UQ52/1	L290/320 Model Slide		11/7/2022	MKLEPADLO	
&MFS=V1WR1UQ52UQ17+V1WR1UQ52/1	L320 Model Clamps 1		9/30/2022	MKLEPADLO	

1.b

1.d

		Date	11/16/2022	Volvo Trucks North America			Valiant TMS	Table of contents	Drawing name: = 2V03&MFS-PNEU		=
		Ed.	KMAFFRE	P6700 Underbody Floor Skin - Cell 2V03						Document type: MAB	
Modification	Date	Name	Original	Replacement of	Replaced by		Scale 1:1		Project nr: 22-16151	Page	1.c 176

Table of contents

Column X: An automatically generated page was edited

F06_001-Copy

Page	Page description	supplementary page field	Date	Edited by	X
&MFS=V1WR1UQ52UQ18+V1WR1UQ52/1	L320 Model Clamps 2		9/30/2022	MKLEPADLO	
&MFS=V1WR1UQ52UQ19+V1WR1UQ52/1	L320 Model Clamps 3		9/30/2022	MKLEPADLO	
&MFS=V1WR1UQ52UQ20+V1WR1UQ52/1	L230 Model Clamp 2		11/16/2022	KMAFFRE	
&MFS=V2WR1+KH1/1	Incoming air supply (Turn Table)		10/31/2022	KMAFFRE	
&MFS=V2WR1UQ51KF1+V2WR1UQ51/5	AIR SUPPLY CONFIGURATION		9/30/2022	MKLEPADLO	
&MFS=V2WR1UQ51KF1+V2WR1UQ51/11	AIR SUPPLY		9/30/2022	MKLEPADLO	
&MFS=V2WR1UQ51KF2+V2WR1UQ51/5	AIR SUPPLY CONFIGURATION		9/30/2022	MKLEPADLO	
&MFS=V2WR1UQ51KF2+V2WR1UQ51/11	AIR SUPPLY		9/30/2022	MKLEPADLO	
&MFS=V2WR1UQ51UQ1+V2WR1UQ51/1	Common Clamps 1		10/31/2022	KMAFFRE	
&MFS=V2WR1UQ51UQ2+V2WR1UQ51/1	Common Clamps 2		10/31/2022	KMAFFRE	
&MFS=V2WR1UQ51UQ3+V2WR1UQ51/1	L150 Model Clamps		10/31/2022	KMAFFRE	
&MFS=V2WR1UQ51UQ4+V2WR1UQ51/1	Common Shot Pin		10/31/2022	KMAFFRE	
&MFS=V2WR1UQ51UQ5+V2WR1UQ51/1	L150 Model Shot Pin		10/31/2022	KMAFFRE	
&MFS=V2WR1UQ51UQ6+V2WR1UQ51/1	L230/290/320 Model Clamps 1		10/31/2022	KMAFFRE	
&MFS=V2WR1UQ51UQ7+V2WR1UQ51/1	L230/290/320 Model Clamps 2		10/31/2022	KMAFFRE	
&MFS=V2WR1UQ51UQ8+V2WR1UQ51/1	L230 Model Clamp		10/31/2022	KMAFFRE	
&MFS=V2WR1UQ51UQ9+V2WR1UQ51/1	L230 Model Shot Pin		10/31/2022	KMAFFRE	
&MFS=V2WR1UQ51UQ10+V2WR1UQ51/1	L290/320 Model Clamps		10/31/2022	KMAFFRE	
&MFS=V2WR1UQ51UQ11+V2WR1UQ51/1	L290 Model Clamp		10/31/2022	KMAFFRE	
&MFS=V2WR1UQ51UQ12+V2WR1UQ51/1	L290 Model Shot Pin		10/31/2022	KMAFFRE	
&MFS=V2WR1UQ51UQ13+V2WR1UQ51/1	L320 Model Clamps		10/31/2022	KMAFFRE	
&MFS=V2WR1UQ51UQ14+V2WR1UQ51/1	L320 Model Shot Pin		10/31/2022	KMAFFRE	
&MPB+KH0/1	Material specification		10/31/2022	KMAFFRE	
&MPB+KH1/1	Material specification		10/31/2022	KMAFFRE	
&MPB+V1AR11UQ41/1	Material specification		9/23/2022	MKLEPADLO	
&MPB+V1AR12UQ41/1	Material specification		9/23/2022	MKLEPADLO	
&MPB+V1AR12UQ42/1	Material specification		9/23/2022	MKLEPADLO	
&MPB+V1AR13UQ41/1	Material specification		9/23/2022	MKLEPADLO	
&MPB+V1GL12UQ51/1	Material specification		10/31/2022	KMAFFRE	
&MPB+V1PF1/1	Material specification		10/31/2022	KMAFFRE	
&MPB+V1UQ51/1	Material specification		9/23/2022	MKLEPADLO	
&MPB+V1UQ51/1.a	Material specification		9/23/2022	MKLEPADLO	
&MPB+V1WR1UQ51/1	Material specification		10/31/2022	KMAFFRE	

1.c

1.e

		Date	11/16/2022	Volvo Trucks North America			Valiant TMS	Table of contents	Drawing name: = 2V03&MFS-PNEU		=
		Ed.	KMAFFRE	P6700 Underbody Floor Skin - Cell 2V03						Document type: MAB	
Modification	Date	Name	Original	Replacement of	Replaced by		Scale 1:1		Project nr: 22-16151	Page	1.d 176

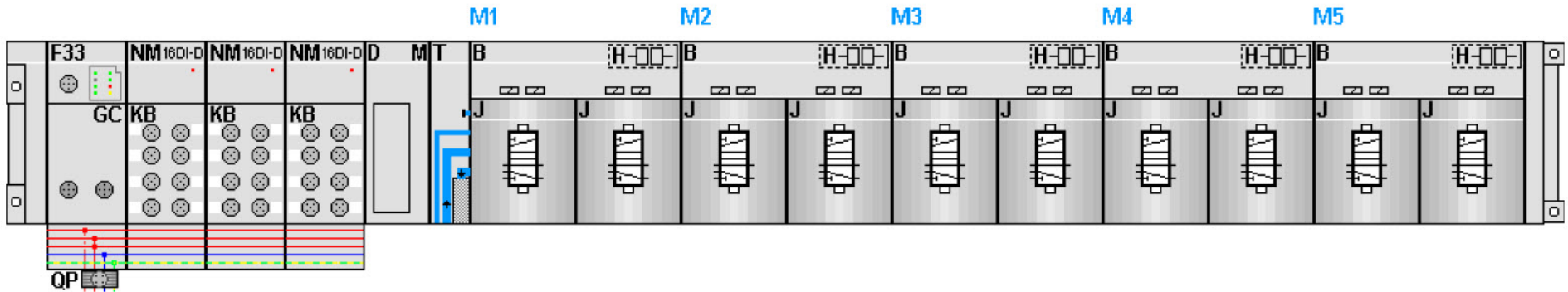

KF1.0

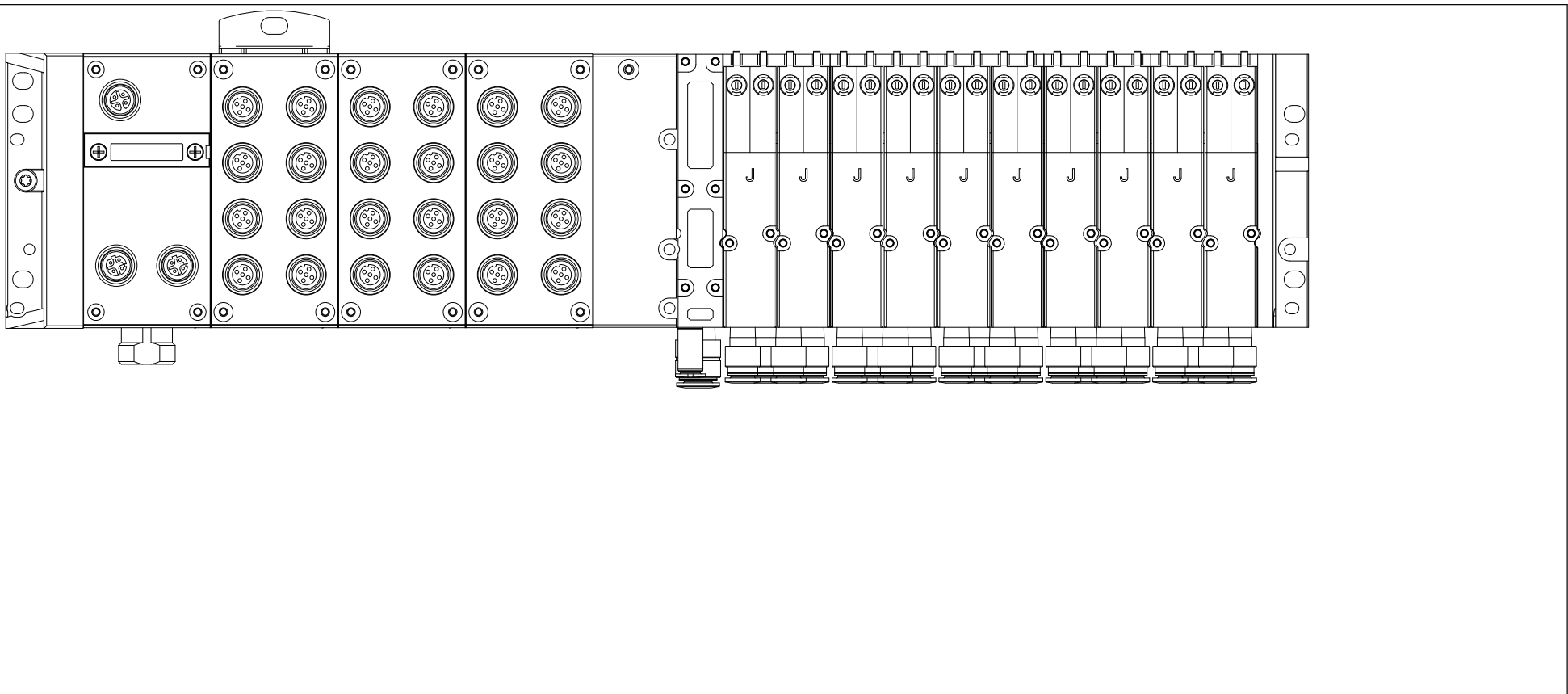

1

11

		Date	9/30/2022	Volvo Trucks North America		Valiant TMS	AIR SUPPLY	Drawing name:		= V1AR11UQ41KF1
		Ed.	MKLEPADLO					= 2V03&MFS-PNEU		+ V1AR11UQ41
		Appr		P6700 Underbody Floor Skin - Cell 2V03		Scale 1:1	Document type:		Project nr:	Page
Modification	Date	Name	Original	Replacement of	Replaced by		MFS	22-16151		5

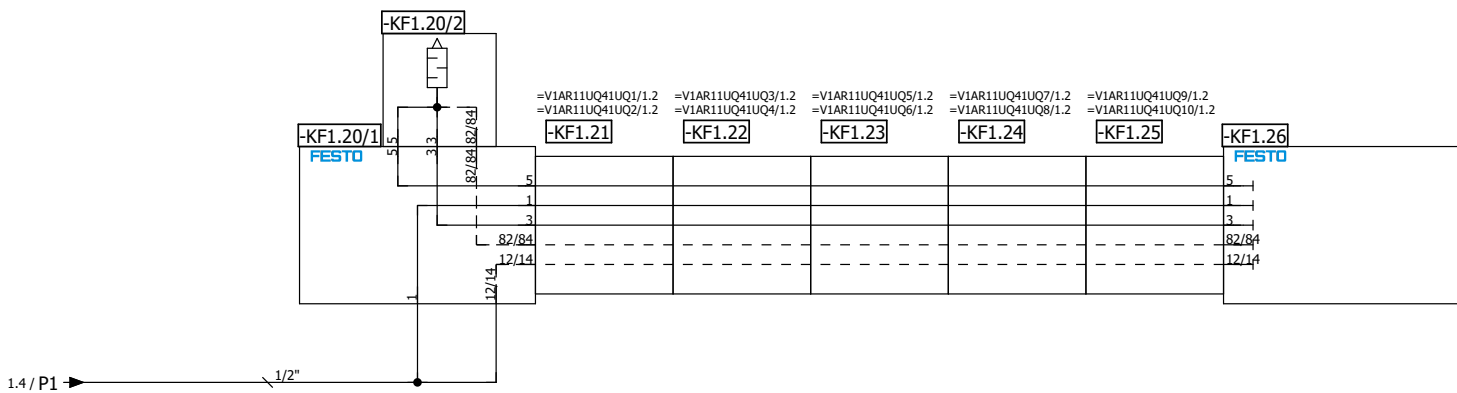
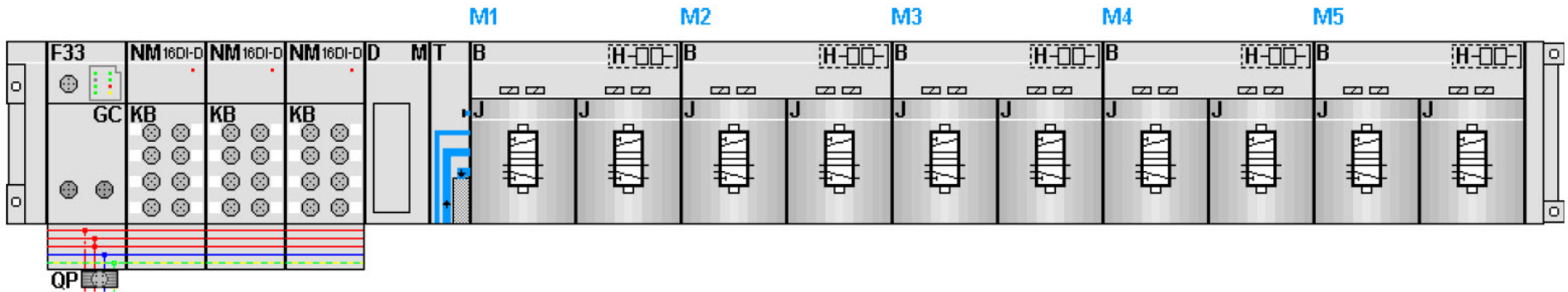

=V1AR11UQ41UQ1/1

Date		11/11/2022	Volvo Trucks North America		Valiant TMS	AIR SUPPLY	Drawing name:		= 2V03&MFS-PNEU	= V1AR11UQ41KF1	
Ed.		KMAFFRE	P6700 Underbody Floor Skin - Cell 2V03				Document type:		MFS	Project nr:	22-16151
Appr			Replacement of		Scale 1:1					Page	176
Modification	Date	Name	Original	Replaced by							

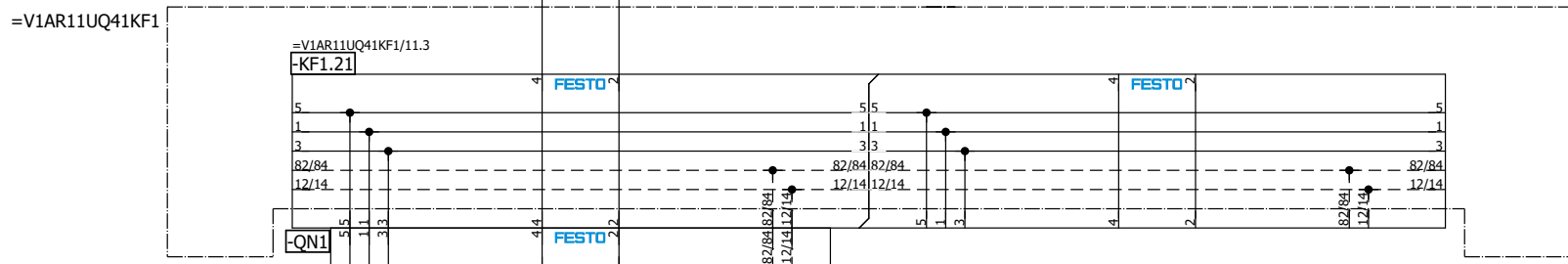
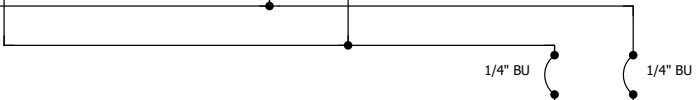
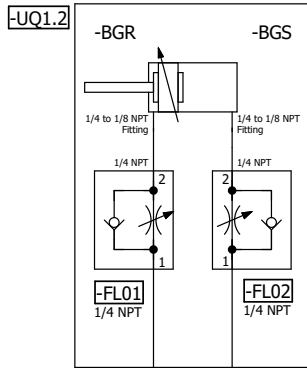
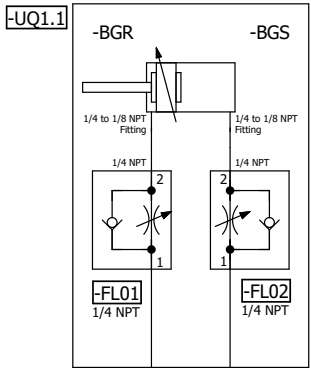

=V1AR11UQ41
-UQ1-QN1.1
L230/290/320 RR
Pnl Shot Pins (RST)

=V1AR11UQ41
-UQ1-QN1.2
L230/290/320 RR
Pnl Shot Pins (SET)

FES.537953
VMPA2-M1H-J-PI

=V1AR11UQ41KF1/11

=V1AR11UQ41UQ2/1

Date	11/4/2022	Volvo Trucks North America	Valiant TMS	L230/290/320 RR Pnl Shot Pins	Drawing name:	= 2V03&MFS-PNEU	= V1AR11UQ41UQ1
Ed.	KMAFFRE				Document type:	MFS	+ V1AR11UQ41
Appr		P6700 Underbody Floor Skin - Cell 2V03			Project nr:	22-16151	Page 1
Modification	Date	Name	Original	Replacement of	Replaced by	Scale 1:1	176

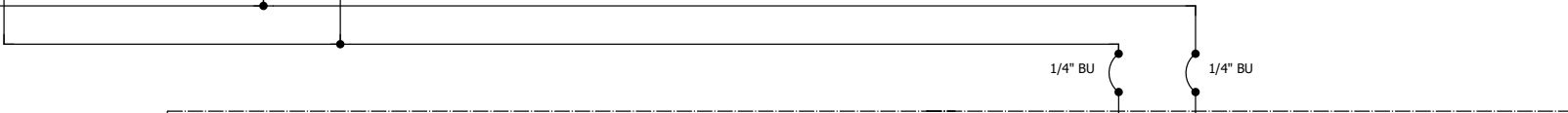
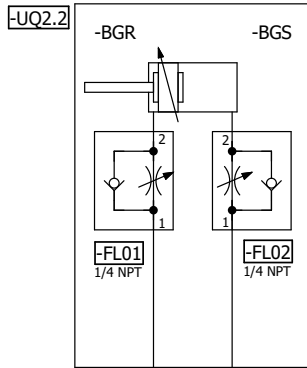
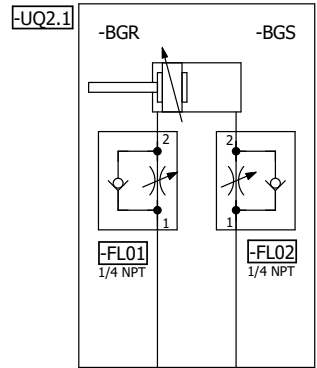

=V1AR11UQ41KF1

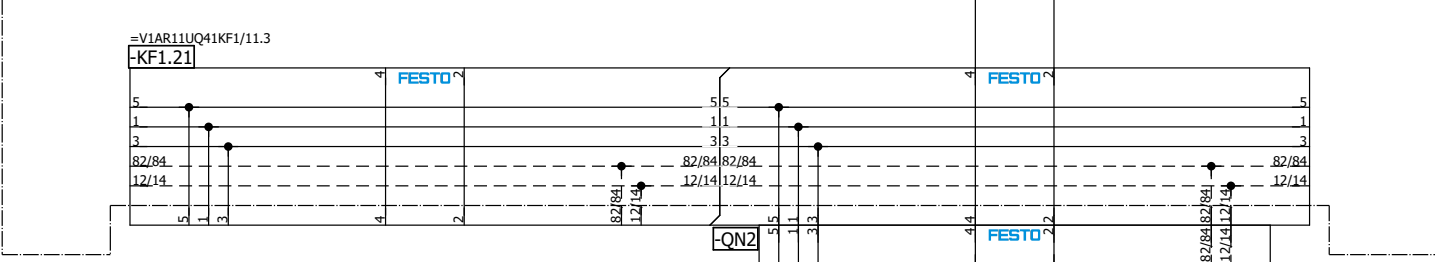

=V1AR11UQ41
-UQ2-QN2.1
Common
Shot Pins (RST)

=V1AR11UQ41
-UQ2-QN2.2
Common
Shot Pins (SET)

FES.537953
VMPA2-M1H-J-PI

=V1AR11UQ41UQ3/1

=V1AR11UQ41UQ1/1

Date	11/4/2022	Volvo Trucks North America	Valiant TMS	Common Shot Pins	Drawing name:	= 2V03&MFS-PNEU	= V1AR11UQ41UQ2
Ed.	KMAFFRE						+ V1AR11UQ41
Appr		P6700 Underbody Floor Skin - Cell 2V03			Document type:	MFS	Project nr:
Original		Replacement of	Replaced by	Scale 1:1			22-16151
Modification	Date	Name					Page
							1
							176

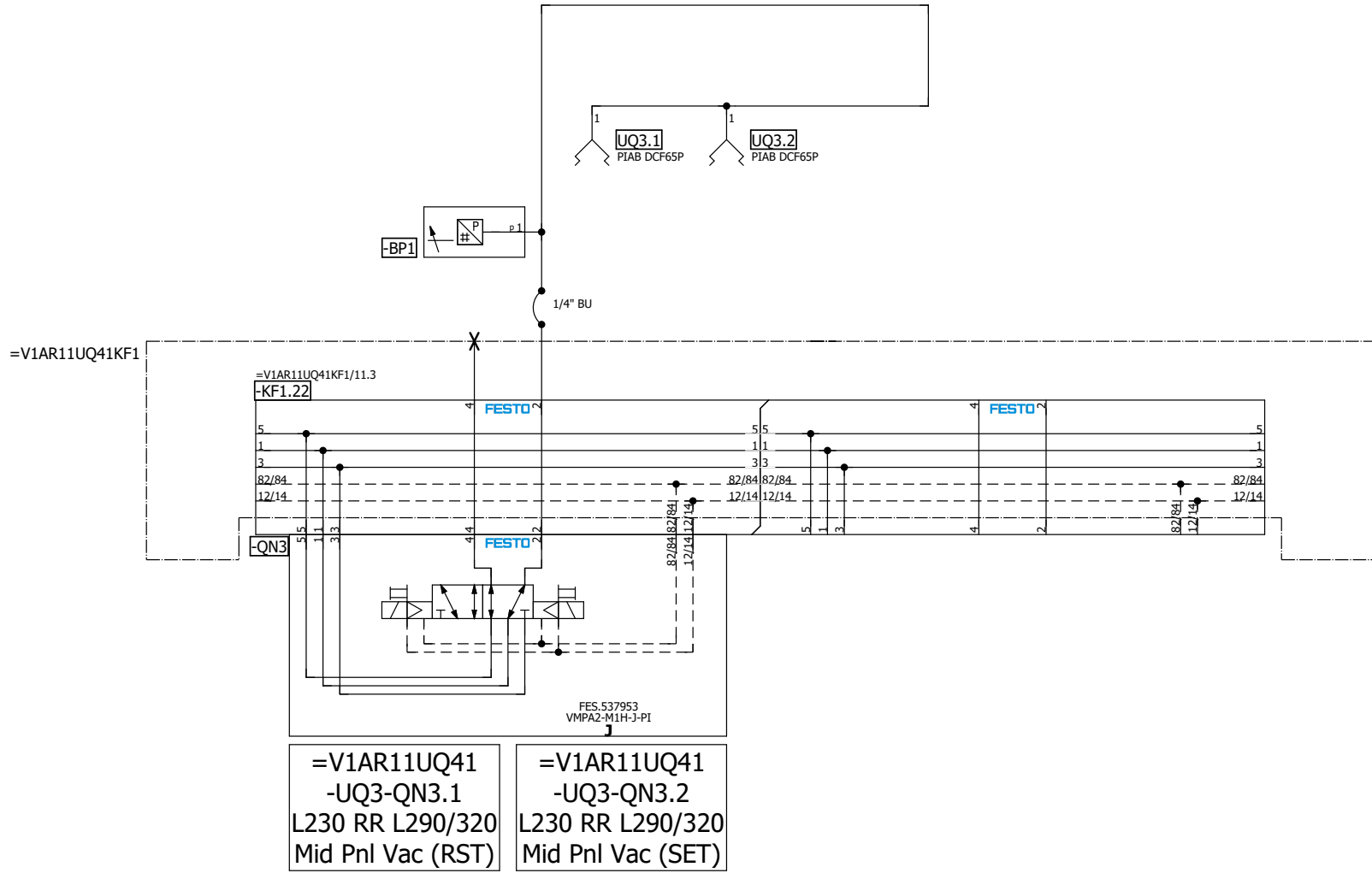

=V1AR11UQ41UQ2/1			Date	11/4/2022	Volvo Trucks North America	Valiant TMS	L230 RR L290/320 Mid Pnl Vacuums	Drawing name:	= 2V03&MFS-PNEU	= V1AR11UQ41UQ3	
			Ed.	KMAFFRE				Document type:	MFS	+ V1AR11UQ41	
			Appr		P6700 Underbody Floor Skin - Cell 2V03			Project nr:	22-16151	Page	1
Modification	Date	Name	Original		Replacement of	Replaced by	Scale 1:1				176

=V1AR11UQ41UQ4/1

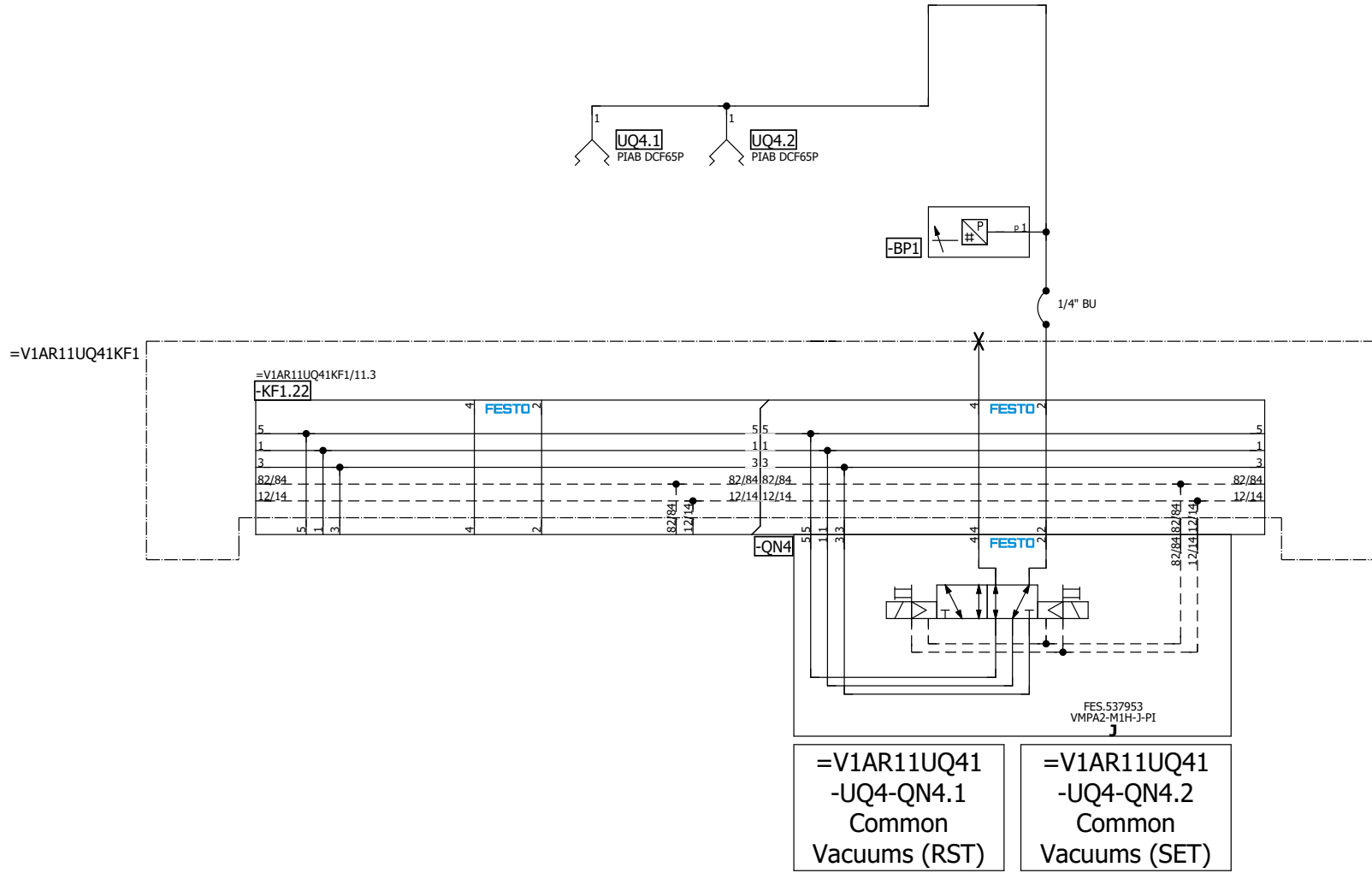

=V1AR11UQ41UQ3/1

=V1AR11UQ41UQ5/1

		Date	11/4/2022	Volvo Trucks North America		Valiant TMS		Common Vacuums		Drawing name: = 2V03&MFS-PNEU		= V1AR11UQ41UQ4 + V1AR11UQ41	
		Ed.	KMAFFRE							Document type:		Project nr:	
		Appr		P6700 Underbody Floor Skin - Cell 2V03						MFS		22-16151	
Modification	Date	Name	Original	Replacement of	Replaced by	Scale 1:1						Page	1
													176

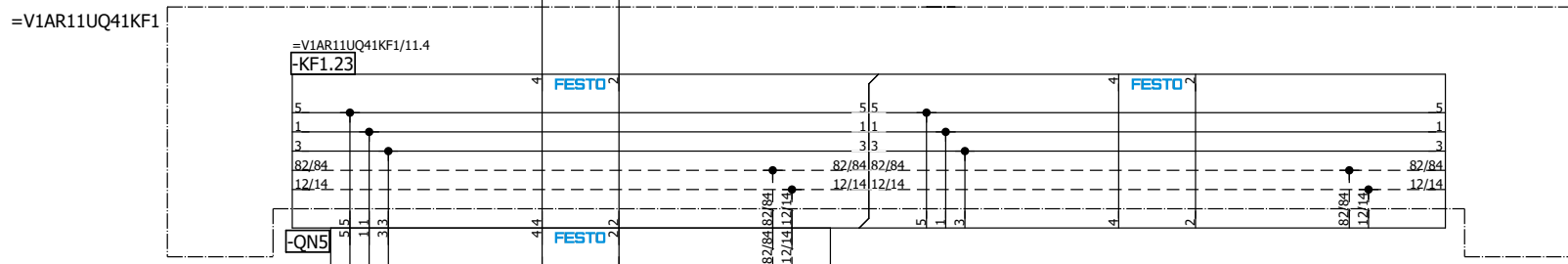
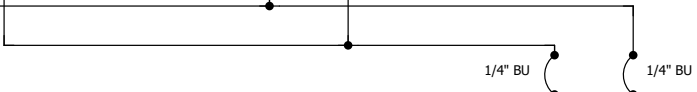
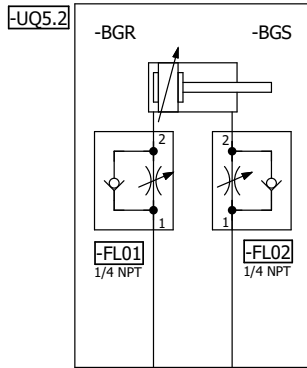
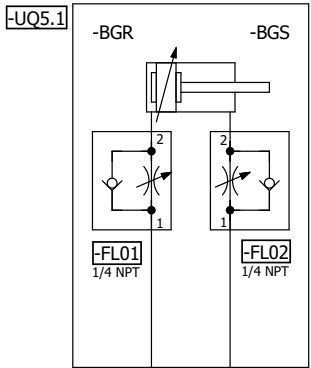

=V1AR11UQ41
-UQ5-QN5.1
L320 RR/Mid L230
/290 RR Clp (RST)

=V1AR11UQ41
-UQ5-QN5.2
L320 RR/Mid L230
/290 RR Clp (SET)

FES.537953
VMPA2-M1H-J-PI

=V1AR11UQ41UQ4/1

=V1AR11UQ41UQ6/1

Date	11/4/2022	Volvo Trucks North America	Valiant TMS	L320 RR/Mid L230 /290 RR Clamps	Drawing name:	= 2V03&MFS-PNEU	= V1AR11UQ41UQ5
Ed.	KMAFFRE	P6700 Underbody Floor Skin - Cell 2V03	Scale 1:1		Document type:	MFS	+ V1AR11UQ41
Appr					Project nr:	22-16151	Page
Modification	Date	Name	Original	Replacement of	Replaced by		176

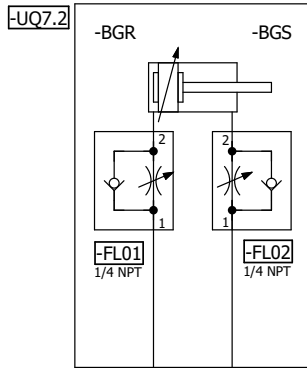
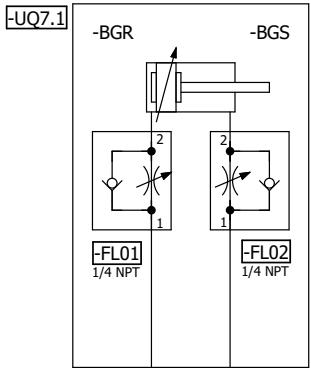

=V1AR11UQ41KF1

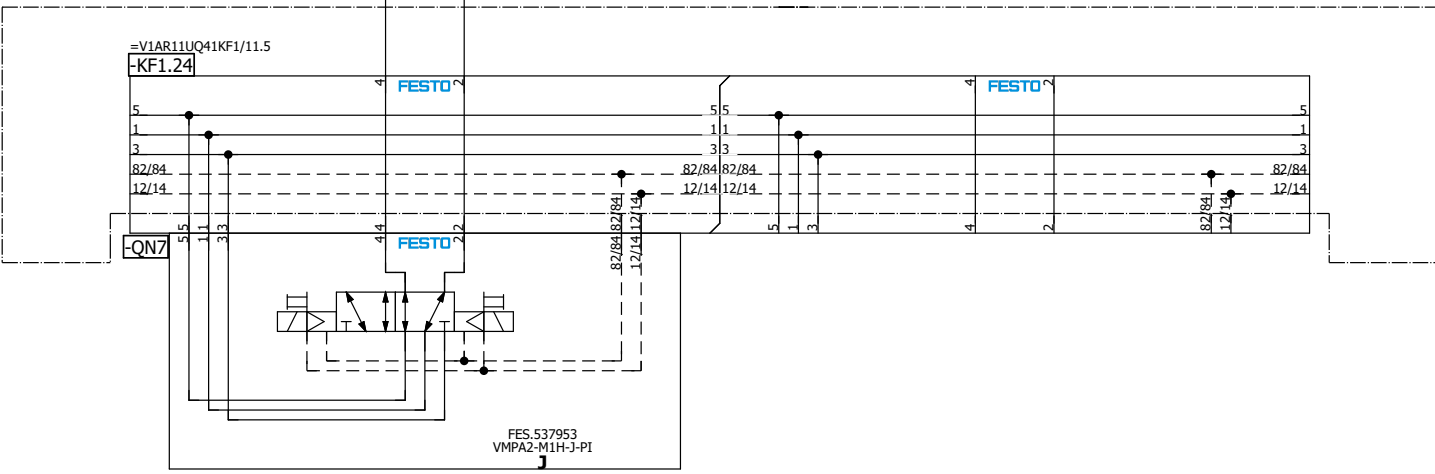

=V1AR11UQ41
-UQ7-QN7.1
L290 Mid Pnl
Clamps (RST)

=V1AR11UQ41
-UQ7-QN7.2
L290 Mid Pnl
Clamps (SET)

=V1AR11UQ41UQ6/1

=V1AR11UQ41UQ8/1

Date	11/4/2022	Volvo Trucks North America	Valiant TMS	L290 Mid Pnl Clamps	Drawing name:	= 2V03&MFS-PNEU	= V1AR11UQ41UQ7
Ed.	KMAFFRE				Document type:	MFS	+ V1AR11UQ41
Appr		P6700 Underbody Floor Skin - Cell 2V03			Project nr:	22-16151	Page 1
Modification	Date	Name	Original	Replacement of	Replaced by	Scale 1:1	176

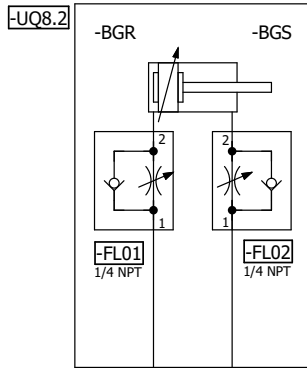
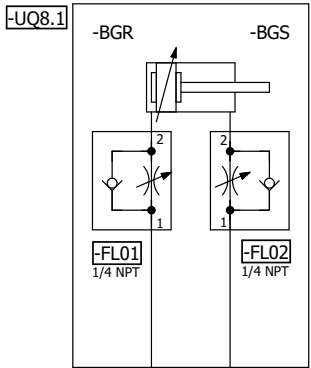

=V1AR11UQ41KF1

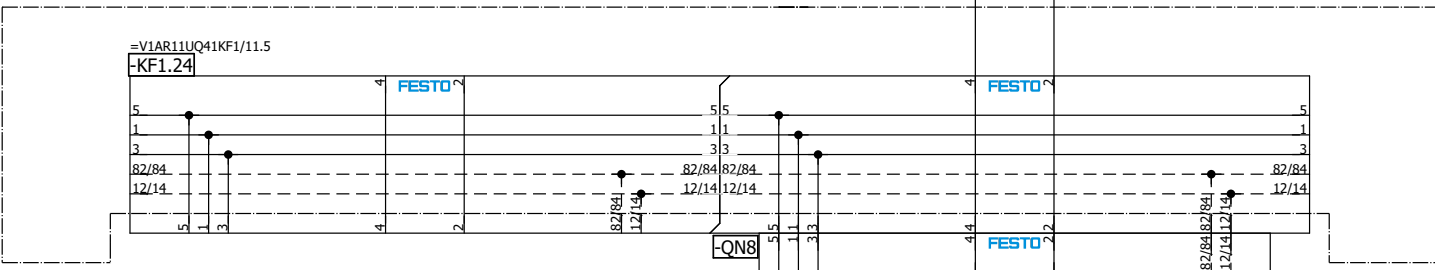

=V1AR11UQ41
-UQ8-QN8.1
L320 Mid Pnl
Shot Pins (RST)

=V1AR11UQ41
-UQ8-QN8.2
L320 Mid Pnl
Shot Pins (SET)

=V1AR11UQ41UQ9/1

			Date	11/4/2022	Volvo Trucks North America		Valiant TMS	L290 Model Clamps	Drawing name:		= V1AR11UQ41UQ8		
			Ed.	KMAFFRE					= 2V03&MFS-PNEU		+ V1AR11UQ41		
			Appr		P6700 Underbody Floor Skin - Cell 2V03		Scale 1:1	Document type:		MFS	Project nr: 22-16151	Page	1
Modification	Date	Name	Original		Replacement of	Replaced by						Page	176

=V1AR11UQ41KF1

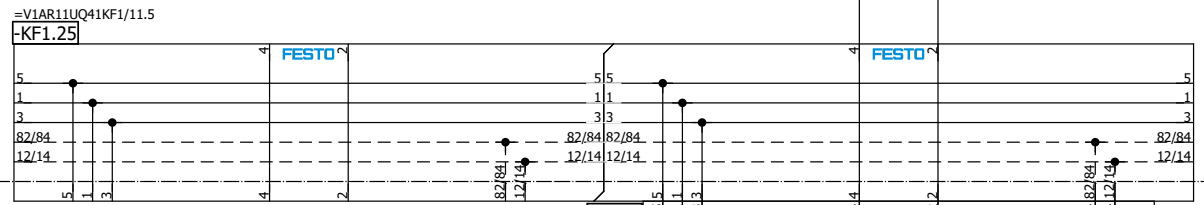

=V1AR11UQ41
-UQ10-QN10.1
Spare
(RST)

=V1AR11UQ41
-UQ10-QN10.2
Spare
(SET)

FES.537953
VMPA2-M1H-J-PI

=V1AR11UQ41UQ9/1

=V1AR12UQ41KF1+.AR12UQ41/1

		Date	9/30/2022	Volvo Trucks North America			Valiant TMS	Spare	Drawing name: = 2V03&MFS-PNEU		= V1AR11UQ41UQ10 + V1AR11UQ41	
		Ed.	MKLEPADLO	P6700 Underbody Floor Skin - Cell 2V03			Scale 1:1		Document type: MFS	Project nr: 22-16151	Page	1
Modification	Date	Name	Original	Replacement of	Replaced by							176

M1

M2

M3

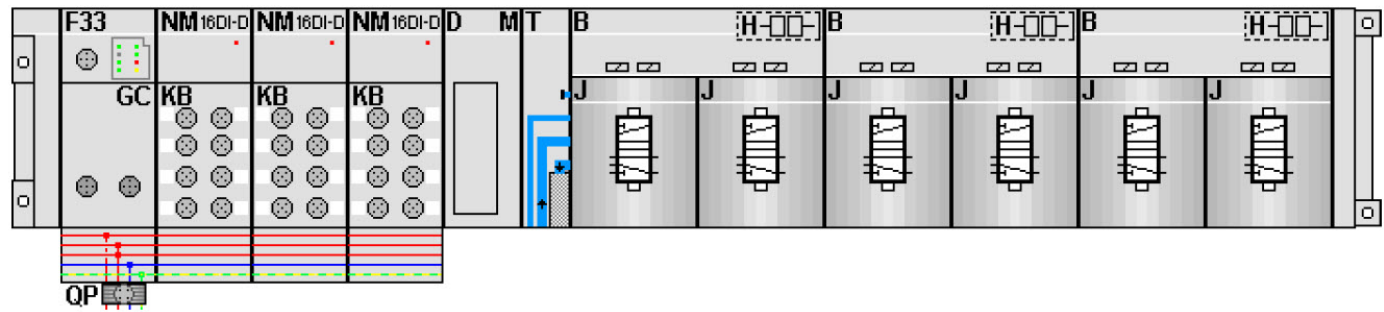

KF1.0

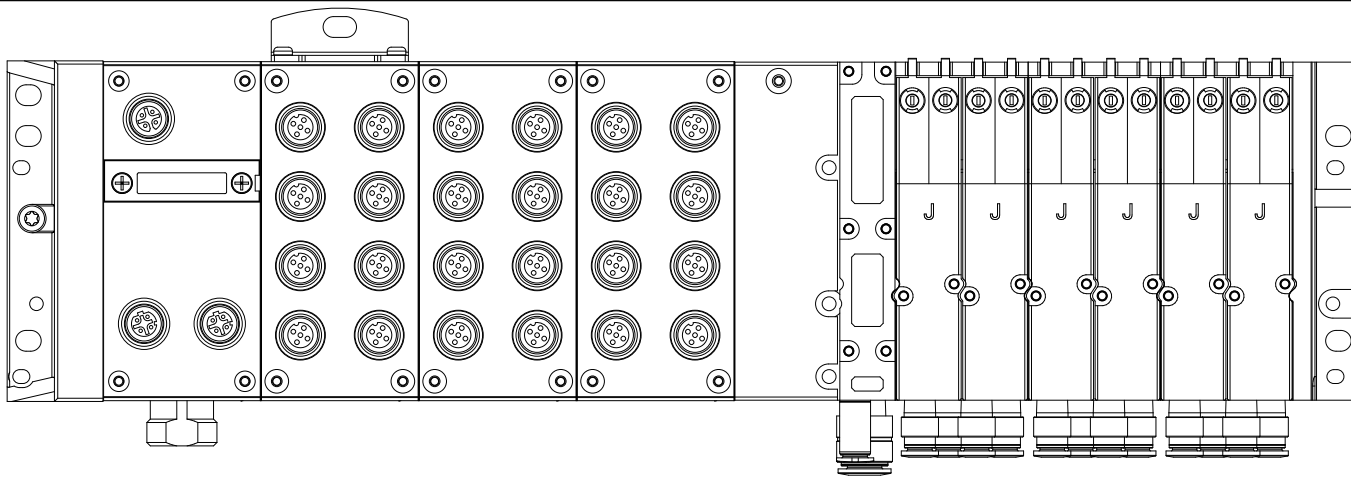

1

11

		Date	9/30/2022	Volvo Trucks North America		Valiant TMS		AIR SUPPLY		Drawing name:		= V1AR12UQ41KF1	
		Ed.	MKLEPADLO							= 2V03&MFS-PNEU		+ V1AR12UQ41	
		Appr		P6700 Underbody Floor Skin - Cell 2V03						Document type:		Project nr:	
Modification	Date	Name	Original	Replacement of	Replaced by	Scale 1:1				MFS		22-16151	
											Page	5	
												176	

M1

M2

M3

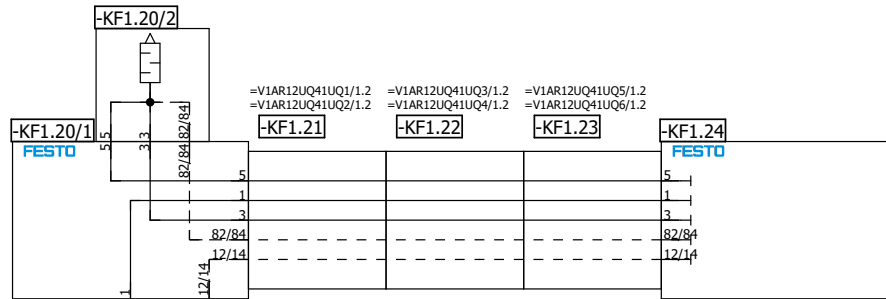
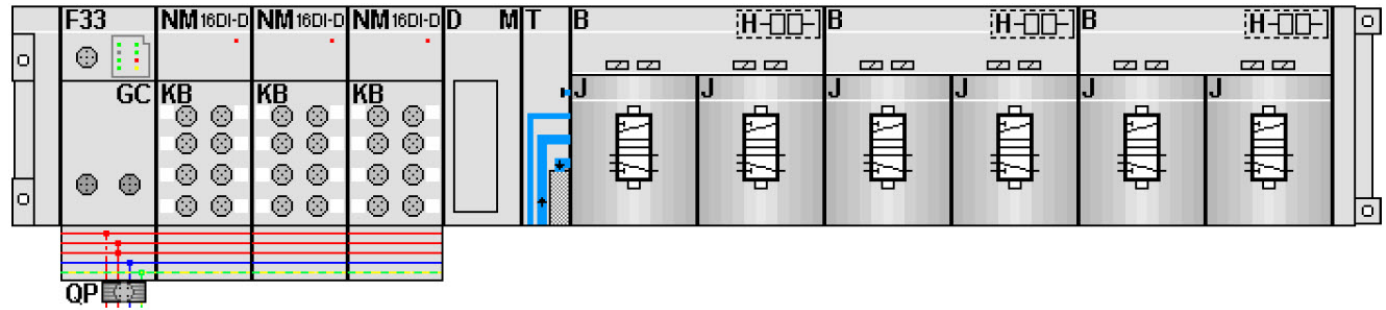

1.4 / P1 → 1/2"

=V1AR12UQ41KF2/5

		Date	11/11/2022	Volvo Trucks North America		Valiant TMS	AIR SUPPLY	Drawing name:		= V1AR12UQ41KF1
		Ed.	KMAFFRE					= 2V03&MFS-PNEU		+ V1AR12UQ41
		Appr		P6700 Underbody Floor Skin - Cell 2V03		Scale 1:1	Document type:		Project nr:	Page
Modification	Date	Name	Original	Replacement of	Replaced by		MFS		22-16151	11
										176

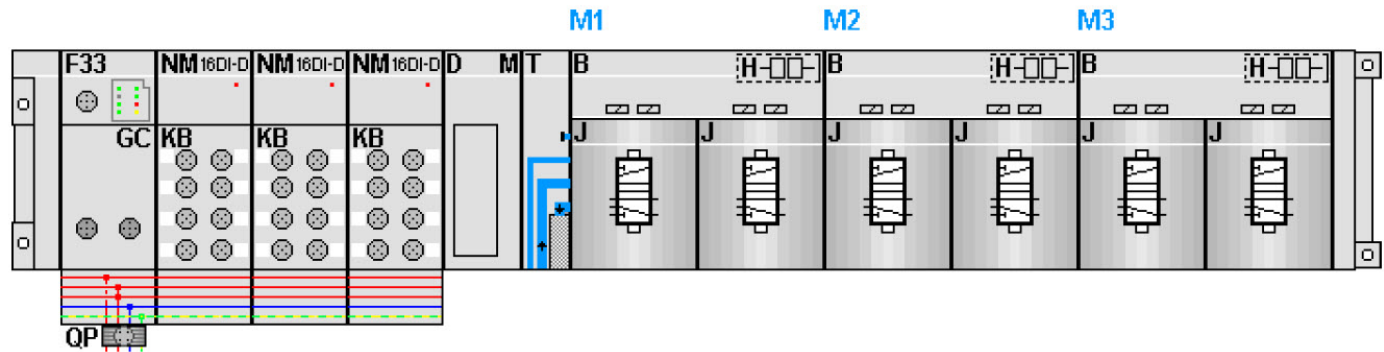

KF2.0

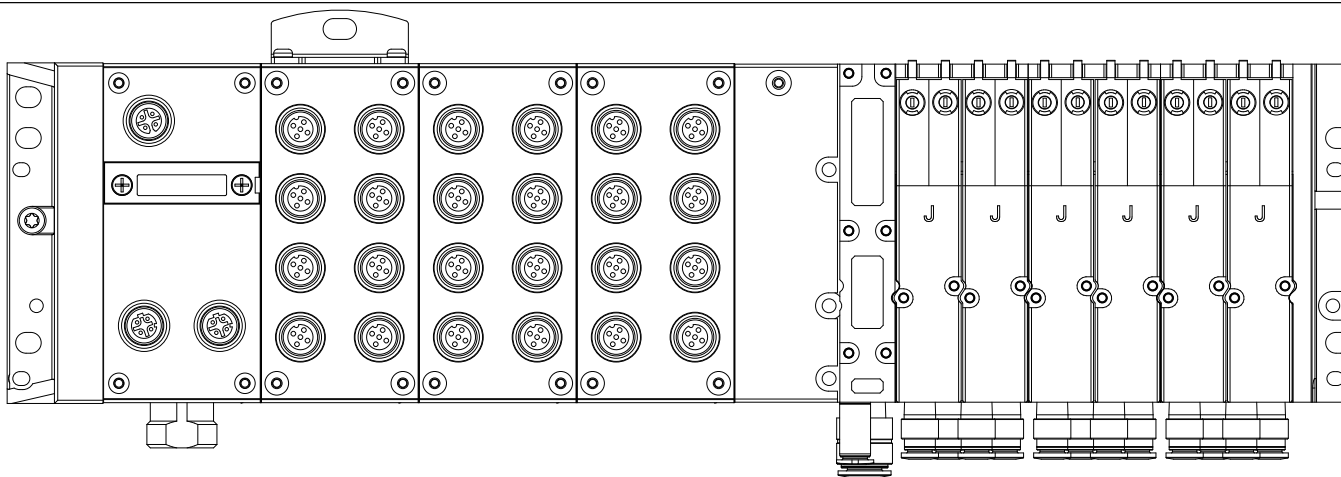

=V1AR12UQ41KF1/11

11

		Date	9/30/2022	Volvo Trucks North America		Valiant TMS		AIR SUPPLY		Drawing name: = 2V03&MFS-PNEU		= V1AR12UQ41KF2	
		Ed.	MKLEPADLO									+ V1AR12UQ41	
		Appr		P6700 Underbody Floor Skin - Cell 2V03						Document type:		Project nr:	
Modification	Date	Name	Original	Replacement of	Replaced by	Scale 1:1				MFS		22-16151	
											Page	5	
												176	

M1 M2 M3

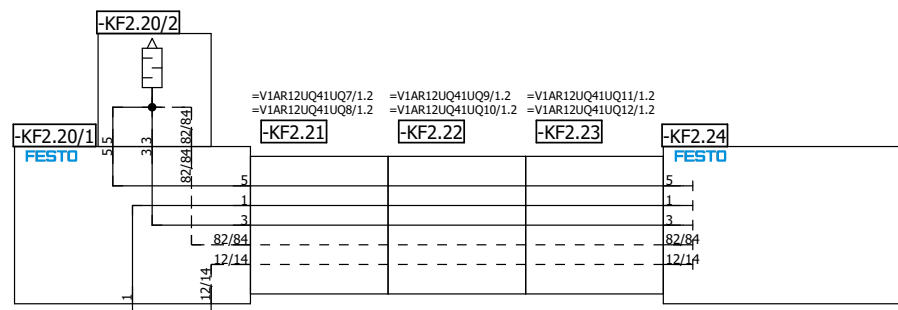
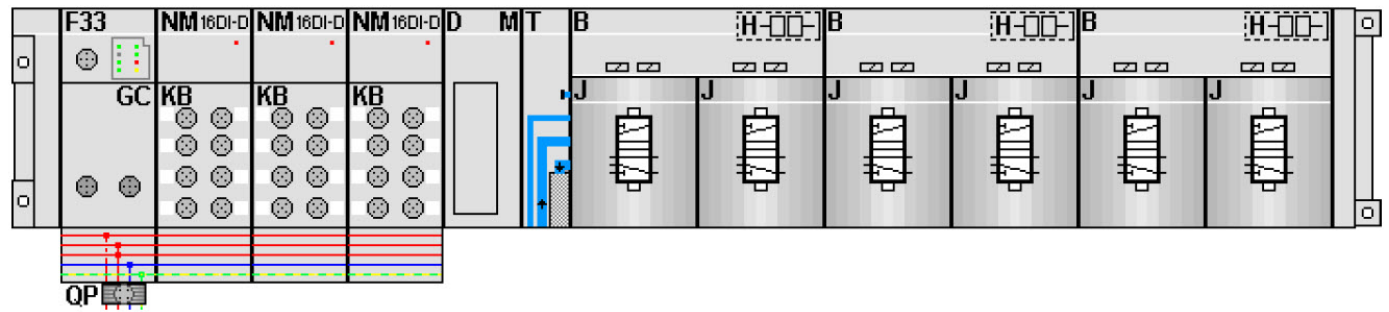

=V1AR12UQ41KF1/1.4 / P2 1/2"

=V1AR12UQ41UQ1/1

5

		Date	11/11/2022	Volvo Trucks North America		Valiant TMS		AIR SUPPLY		Drawing name: = 2V03&MFS-PNEU		= V1AR12UQ41KF2 + V1AR12UQ41	
		Ed.	KMAFFRE							Document type: MFS		Project nr: 22-16151	
		Appr		P6700 Underbody Floor Skin - Cell 2V03								Page 11	
Modification	Date	Name	Original	Replacement of	Replaced by	Scale 1:1						Page 176	

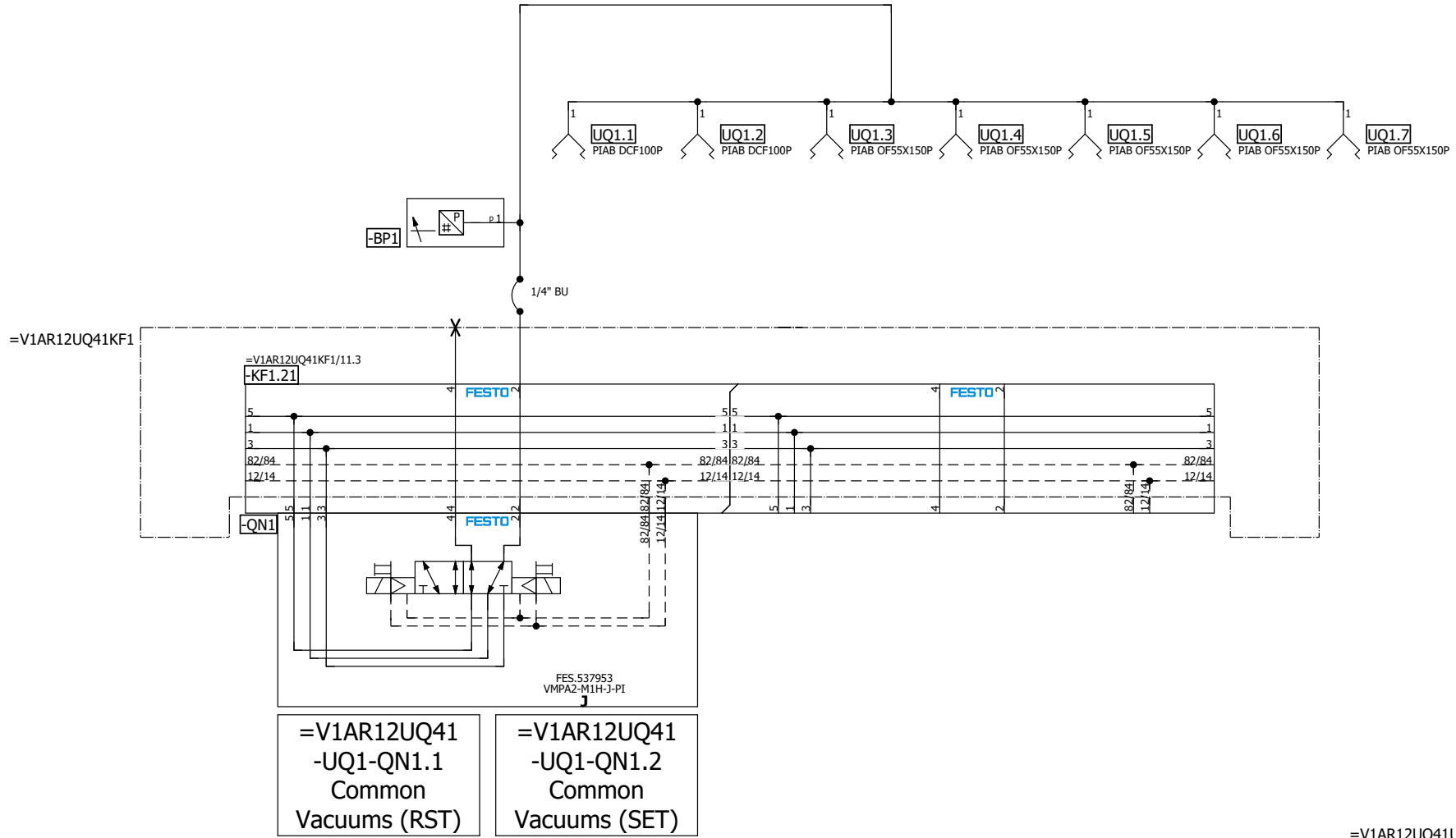

=V1AR12UQ41KF2/11

=V1AR12UQ41UQ2/1

Date	11/4/2022	Volvo Trucks North America	Valiant TMS	Common Vacuums	Drawing name:	= 2V03&MFS-PNEU	= V1AR12UQ41UQ1
Ed.	KMAFFRE	P6700 Underbody Floor Skin - Cell 2V03	Scale 1:1		Document type:	MFS	+ V1AR12UQ41
Appr					Project nr:	22-16151	Page
Modification	Date	Name	Original	Replacement of	Replaced by		176

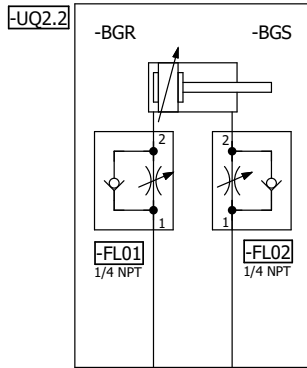
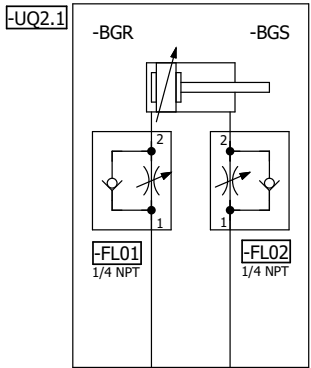

=V1AR12UQ41KF1

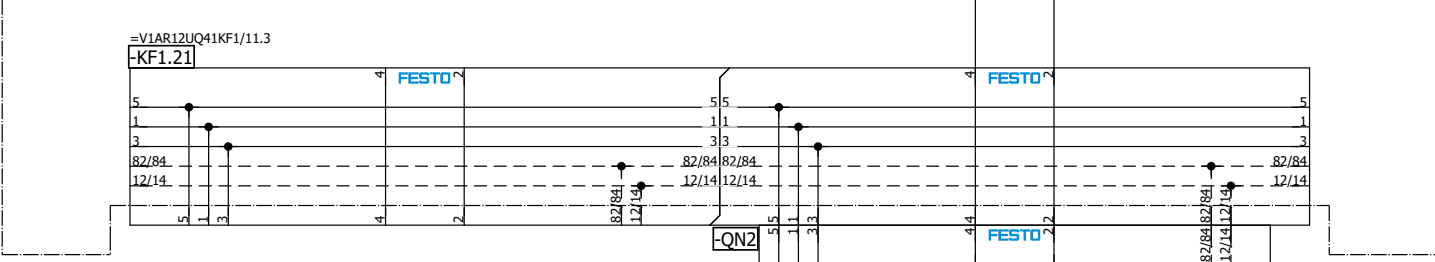

=V1AR12UQ41
-UQ2-QN2.1
Common
Clamps (RST)

=V1AR12UQ41
-UQ2-QN2.2
Common
Clamps (SET)

=V1AR12UQ41UQ3/1

			Date	11/4/2022	Volvo Trucks North America	Valiant TMS	Common Clamps	Drawing name:	= 2V03&MFS-PNEU	= V1AR12UQ41UQ2
			Ed.	KMAFFRE	P6700 Underbody Floor Skin - Cell 2V03	Scale 1:1		Document type:	MFS	+ V1AR12UQ41
Modification	Date	Name	Original	Replacement of				Replaced by	Project nr:	22-16151
										176

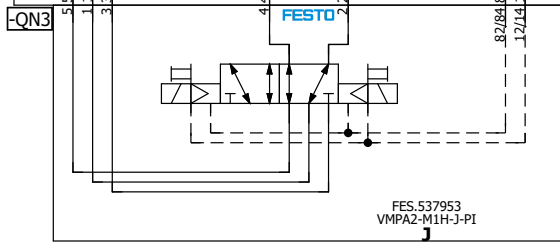
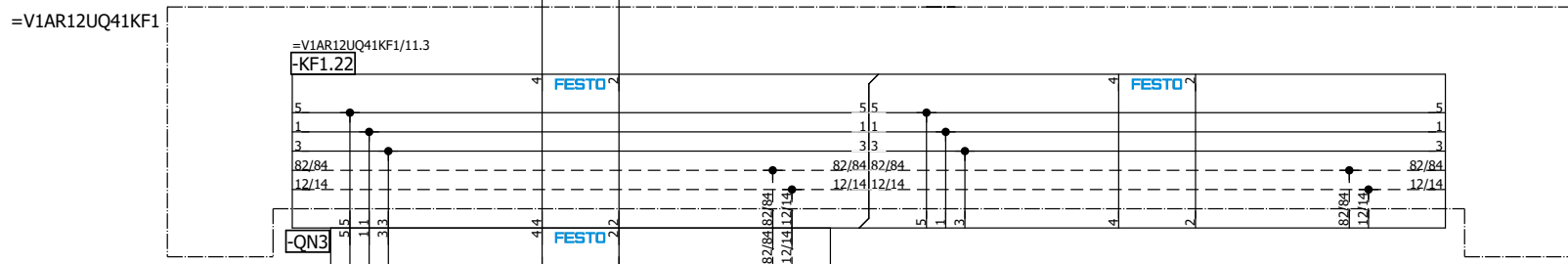
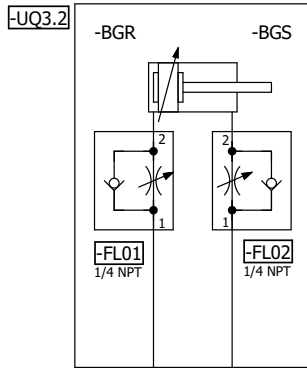
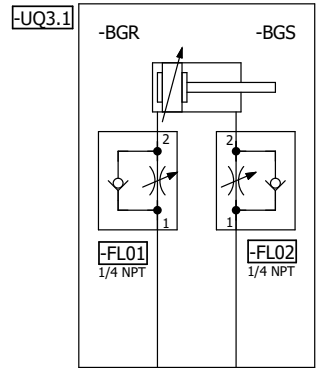

=V1AR12UQ41
-UQ3-QN3.1
L150 Model
Clamps (RST)

=V1AR12UQ41
-UQ3-QN3.2
L150 Model
Clamps (SET)

=V1AR12UQ41UQ2/1

=V1AR12UQ41UQ4/1

Date	11/4/2022	Volvo Trucks North America	Valiant TMS	L150 Model Clamps	Drawing name:	= 2V03&MFS-PNEU	= V1AR12UQ41UQ3
Ed.	KMAFFRE						+ V1AR12UQ41
Appr		P6700 Underbody Floor Skin - Cell 2V03			Document type:	MFS	Project nr:
Modification	Date	Name	Original	Replacement of	Replaced by	Scale 1:1	22-16151
							Page 1
							176

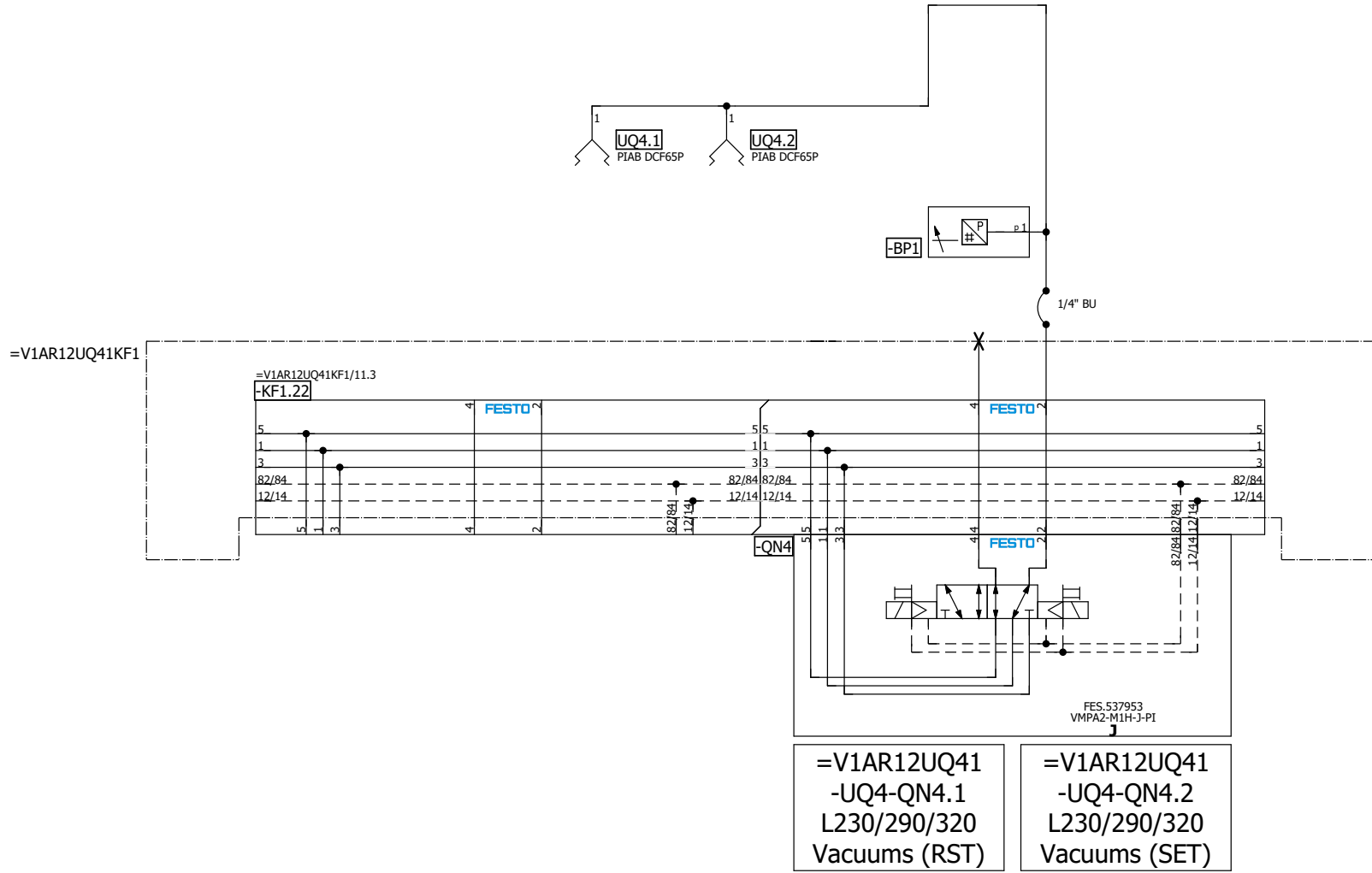

=V1AR12UQ41UQ3/1

=V1AR12UQ41UQ5/1

Date	11/4/2022	Volvo Trucks North America	Valiant TMS	L230/290/320 Model Vacuums	Drawing name:	= V1AR12UQ41UQ4
Ed.	KMAFFRE				= 2V03&MFS-PNEU	+ V1AR12UQ41
Appr		P6700 Underbody Floor Skin - Cell 2V03			Document type:	MFS
Original		Replacement of	Replaced by	Scale 1:1	Project nr:	22-16151
Modification	Date	Name	Original			Page 1
						176

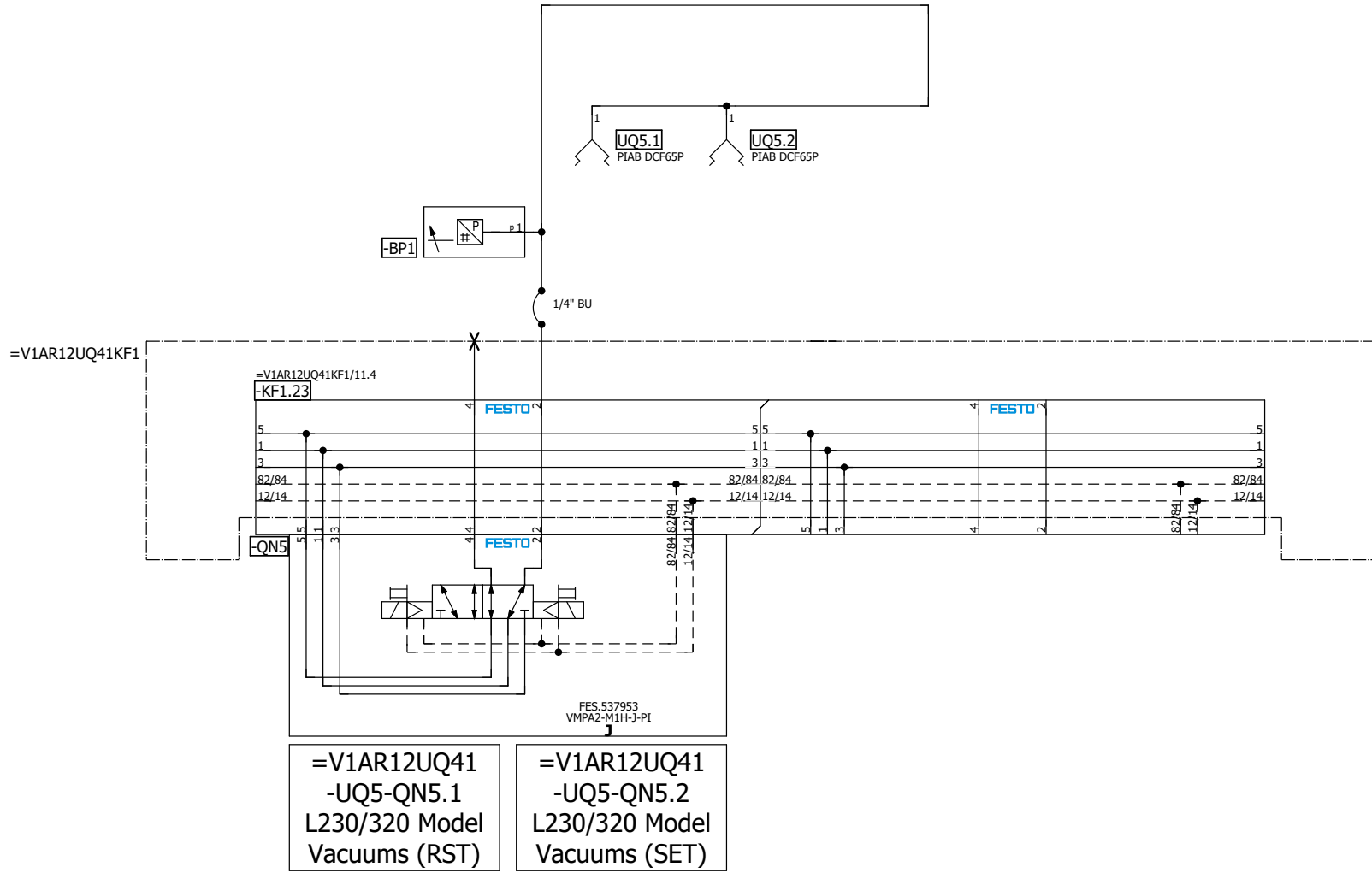

=V1AR12UQ41
-UQ5-QN5.1
L230/320 Model
Vacuums (RST)

=V1AR12UQ41
-UQ5-QN5.2
L230/320 Model
Vacuums (SET)

=V1AR12UQ41UQ4/1

=V1AR12UQ41UQ6/1

Date	11/4/2022	Volvo Trucks North America	Valiant TMS	L230/290 Model Vacuums	Drawing name:	= 2V03&MFS-PNEU	= V1AR12UQ41UQ5
Ed.	KMAFFRE				Document type:	MFS	+ V1AR12UQ41
Appr		P6700 Underbody Floor Skin - Cell 2V03			Project nr:	22-16151	Page 1
Modification	Date	Name	Original	Replacement of	Replaced by	Scale 1:1	176

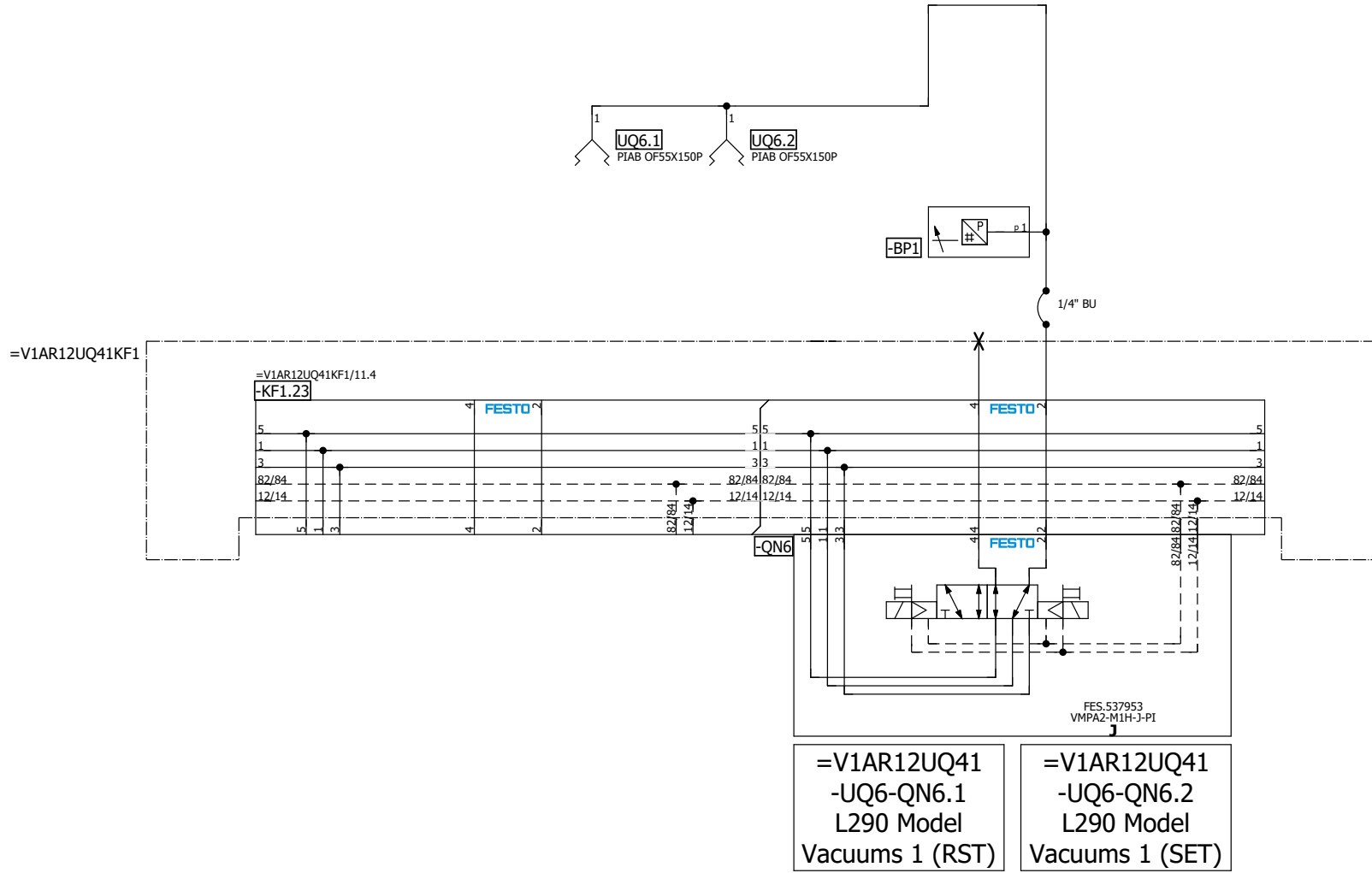

=V1AR12UQ41UQ5/1

Date	11/4/2022
Ed.	KMAFFRE
Appr	
Original	

Volvo Trucks North America
 P6700 Underbody Floor Skin - Cell 2V03
 Replacement of Replaced by

Valiant TMS
 Scale 1:1

L290 Model Vacuums

Drawing name:
 = 2V03&MFS-PNEU
 Document type: MFS
 Project nr: 22-16151

= V1AR12UQ41UQ6
 + V1AR12UQ41
 Page 1
 176

=V1AR12UQ41UQ7/1

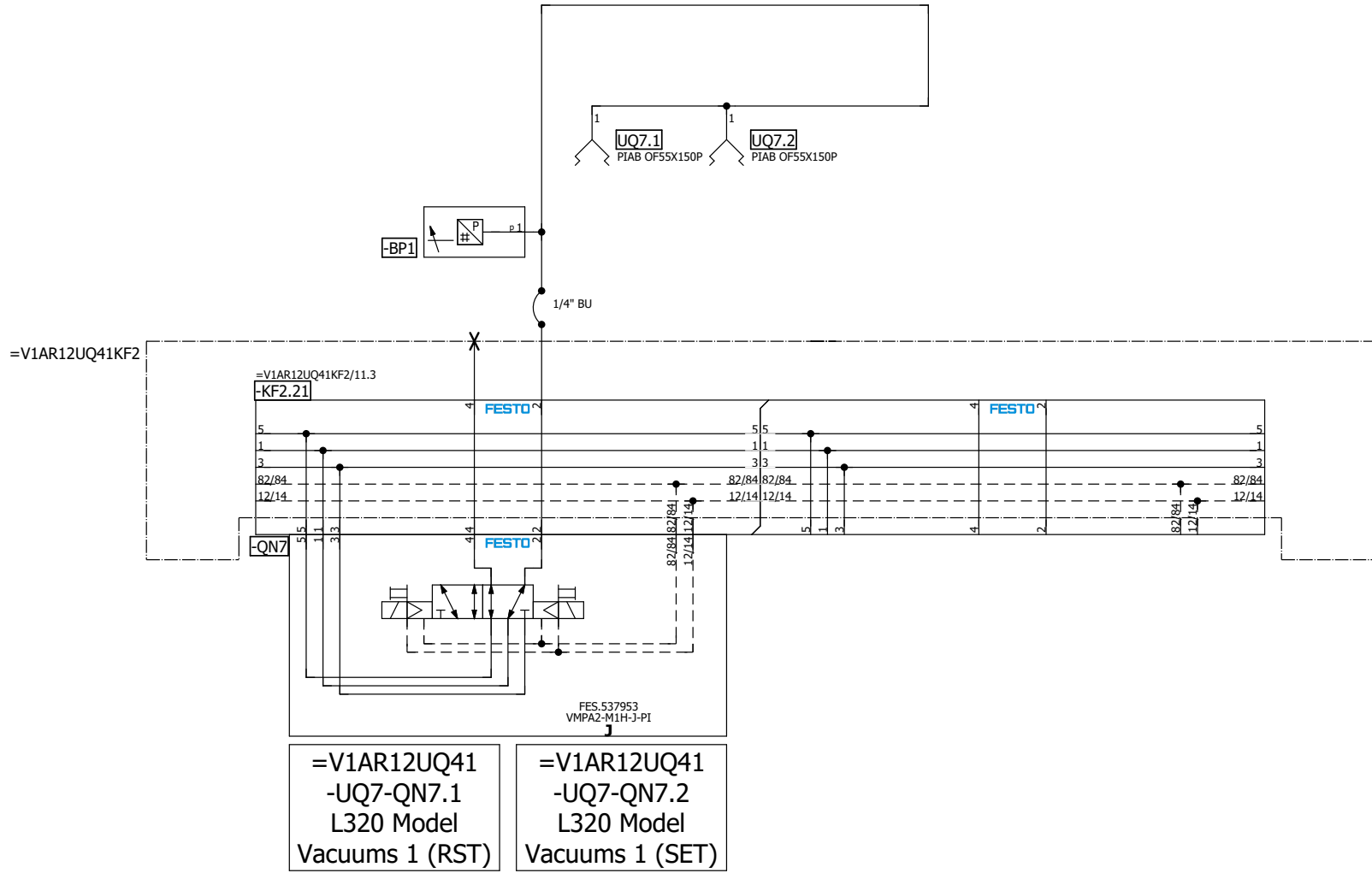

=V1AR12UQ41UQ6/1			Date	11/4/2022	Volvo Trucks North America	Valiant TMS	L320 Model Vacuums 1	Drawing name:	= 2V03&MFS-PNEU	= V1AR12UQ41UQ7			
			Ed.	KMAFFRE				= 2V03&MFS-PNEU		+ V1AR12UQ41			
			Appr		P6700 Underbody Floor Skin - Cell 2V03			Document type:	MFS	Project nr:	22-16151	Page	1
Modification	Date	Name	Original		Replacement of	Replaced by	Scale 1:1					Page	176

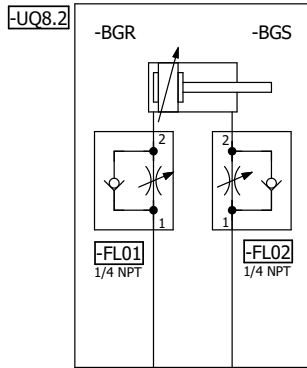
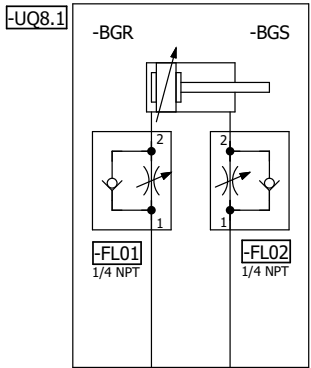

=V1AR12UQ41KF2

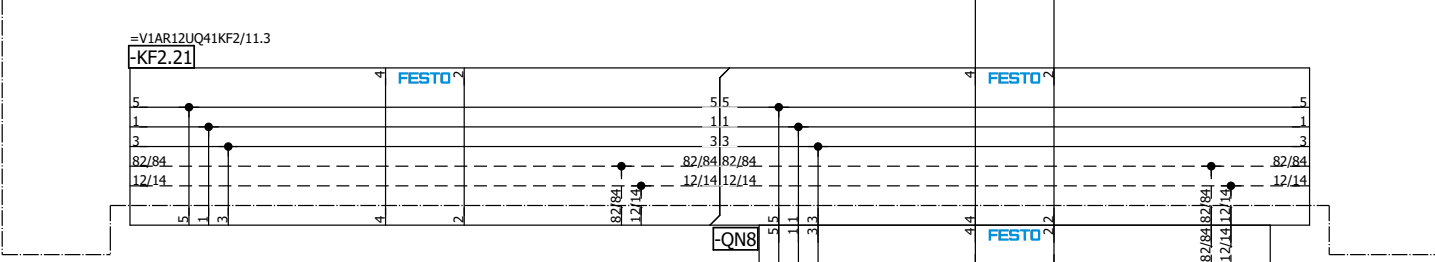

=V1AR12UQ41
-UQ8-QN8.1
L230 Model
Clamps (RST)

=V1AR12UQ41
-UQ8-QN8.2
L230 Model
Clamps (SET)

FES.537953
VMPA2-M1H-J-PI

=V1AR12UQ41UQ7/1

=V1AR12UQ41UQ9/1

Date	11/4/2022	Volvo Trucks North America	Valiant TMS	L230 Model Clamps	Drawing name:	= V1AR12UQ41UQ8
Ed.	KMAFFRE				= 2V03&MFS-PNEU	+ V1AR12UQ41
Appr		P6700 Underbody Floor Skin - Cell 2V03			Document type:	MFS
Modification	Date	Name	Original	Replacement of	Replaced by	Scale 1:1
						Project nr:
						22-16151
						Page
						1
						176

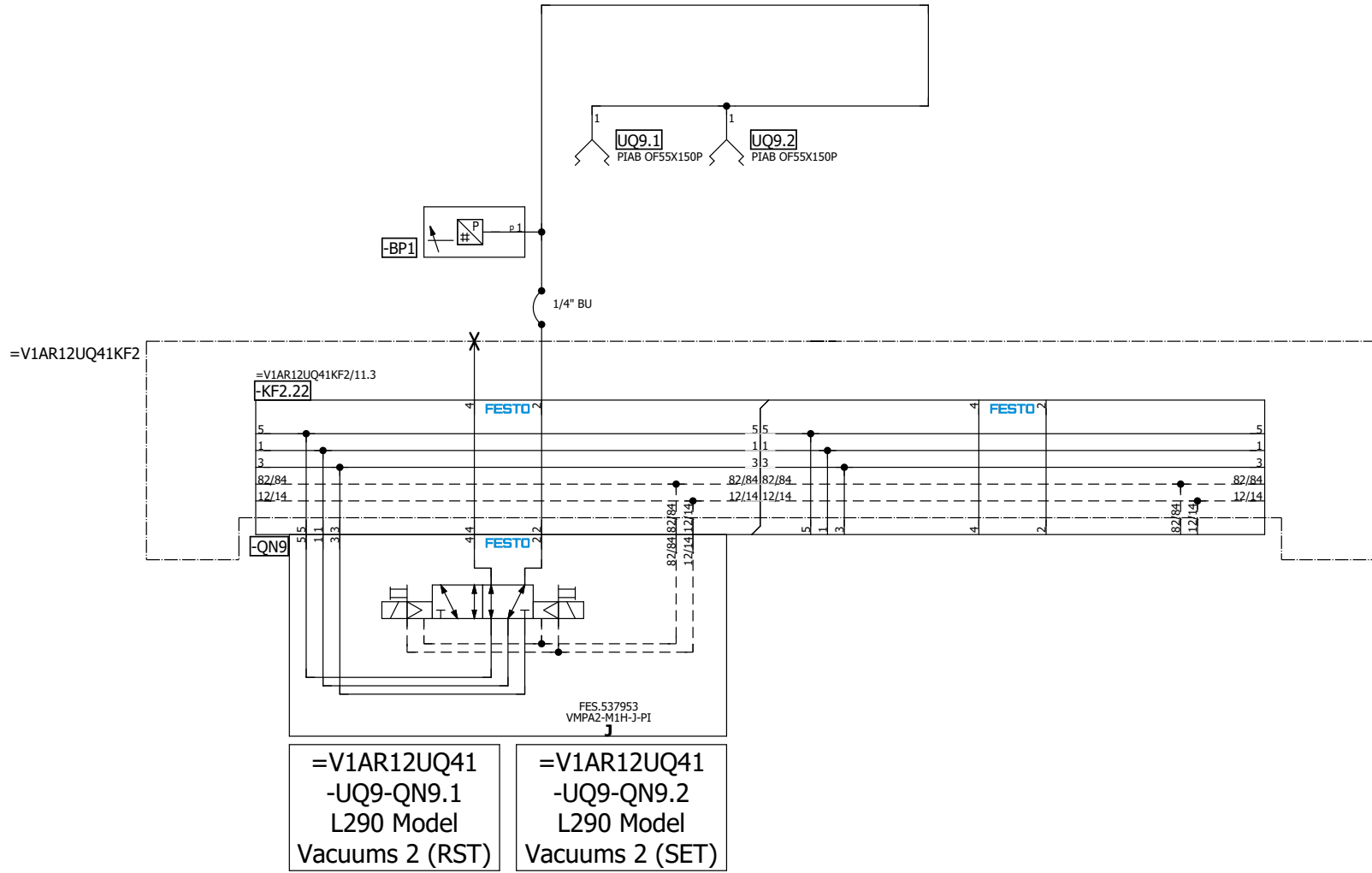

=V1AR12UQ41UQ8/1

=V1AR12UQ41UQ10/1

Date	11/4/2022	Volvo Trucks North America	Valiant TMS	L290 Model Vacuums	Drawing name:	= 2V03&MFS-PNEU	= V1AR12UQ41UQ9
Ed.	KMAFFRE	P6700 Underbody Floor Skin - Cell 2V03	Scale 1:1		Document type:	MFS	+ V1AR12UQ41
Appr					Project nr:	22-16151	Page
Modification	Date	Name	Original	Replacement of	Replaced by		176

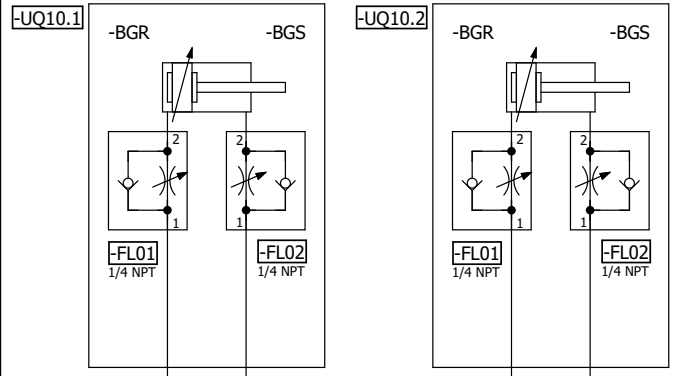

=V1AR12UQ41KF2

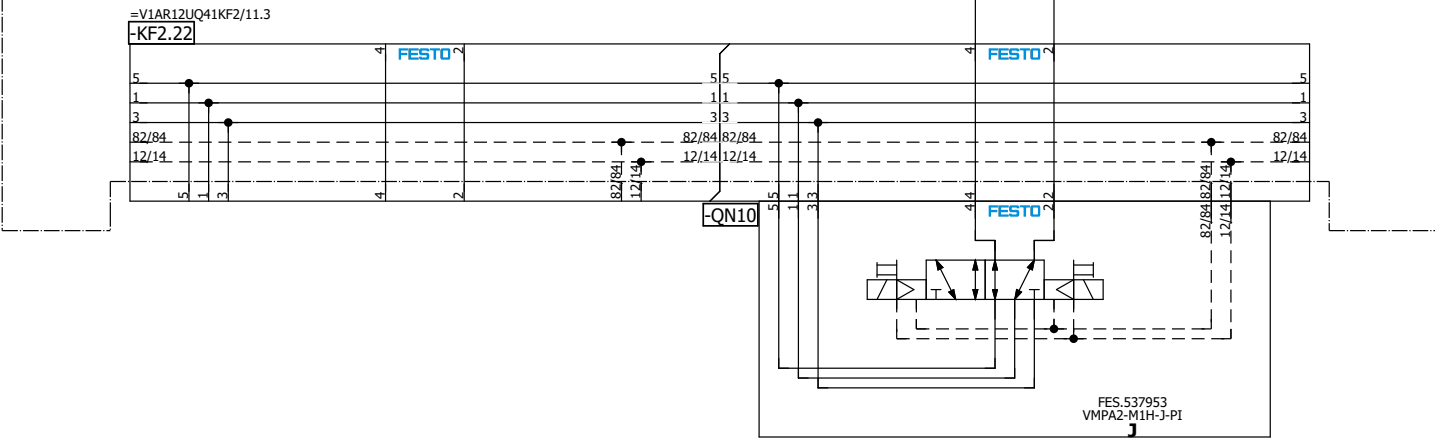

=V1AR12UQ41
-UQ10-QN10.1
L290 Model
Clamps (RST)

=V1AR12UQ41
-UQ10-QN10.2
L290 Model
Clamps (SET)

=V1AR12UQ41UQ11/1

		Date	11/4/2022	Volvo Trucks North America		Valiant TMS		L290 Model Clamps		Drawing name: = 2V03&MFS-PNEU		= V1AR12UQ41UQ10	
		Ed.	KMAFFRE							Document type: MFS		+ V1AR12UQ41	
		Appr		P6700 Underbody Floor Skin - Cell 2V03						Project nr: 22-16151		Page 1	
Modification	Date	Name	Original	Replacement of	Replaced by	Scale 1:1						Page 176	

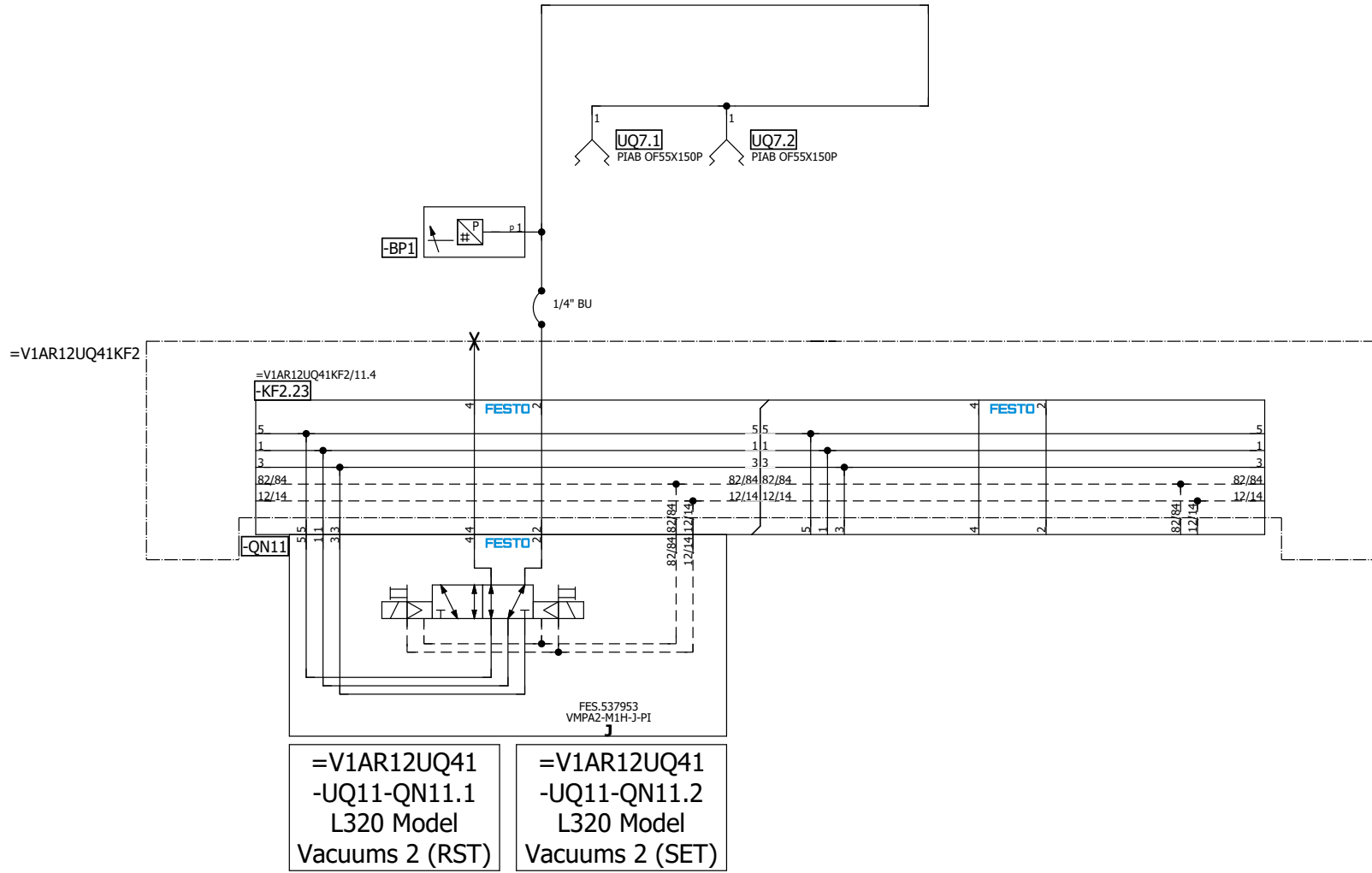

=V1AR12UQ41UQ10/1

=V1AR12UQ41UQ12/1

Date	11/4/2022	Volvo Trucks North America	Valiant TMS	L320 Model Vacuums 2	Drawing name:	= 2V03&MFS-PNEU	= V1AR12UQ41UQ11
Ed.	KMAFFRE	P6700 Underbody Floor Skin - Cell 2V03	Scale 1:1		Document type:	MFS	+ V1AR12UQ41
Appr					Project nr:	22-16151	Page
Modification	Date	Name	Original	Replacement of	Replaced by		176

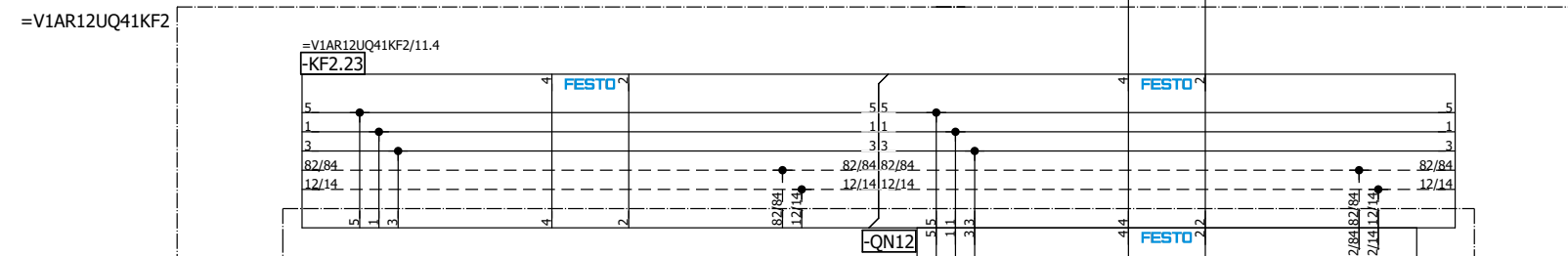
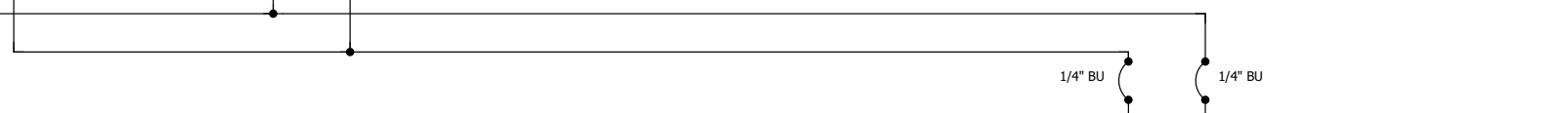
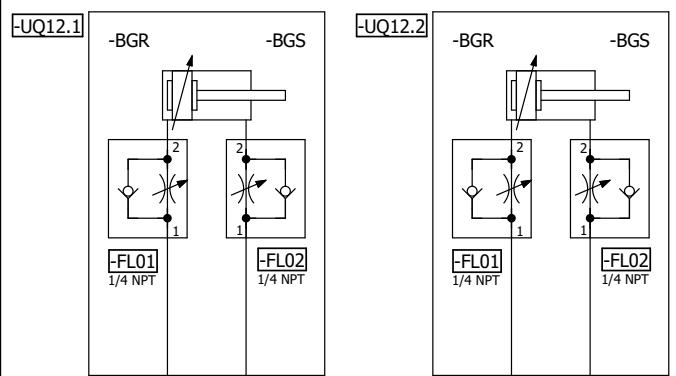

=V1AR12UQ41
-UQ12-QN12.1
L320 Model
Clamps (RST)

=V1AR12UQ41
-UQ12-QN12.2
L320 Model
Clamps (SET)

=V1AR12UQ42KF1+.AR12UQ42/1

=V1AR12UQ41UQ11/1

Date	11/4/2022	Volvo Trucks North America	Valiant TMS	L320 Model Clamps	Drawing name:	= V1AR12UQ41UQ12
Ed.	KMAFFRE				= 2V03&MFS-PNEU	+ V1AR12UQ41
Appr		P6700 Underbody Floor Skin - Cell 2V03			Document type:	MFS
Original		Replacement of	Replaced by	Scale 1:1	Project nr:	22-16151
Modification	Date	Name	Original			Page 1
						176

M1

M2

M3

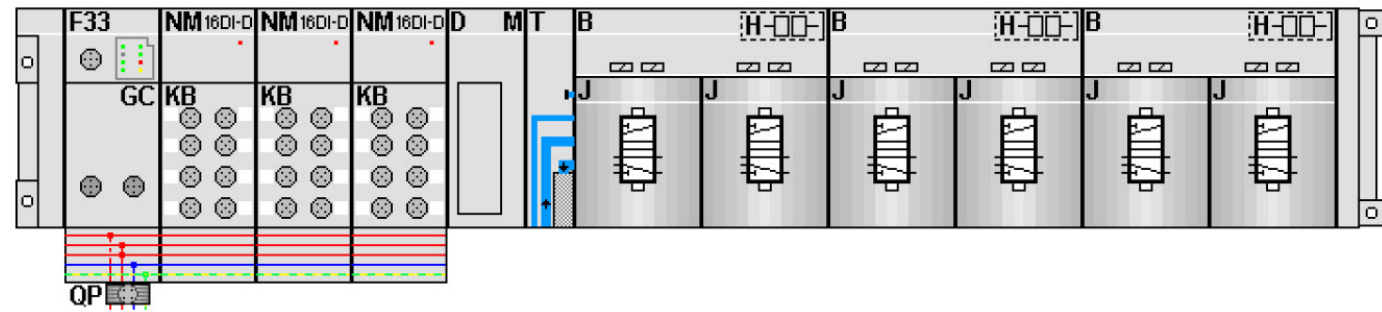

KF1.0

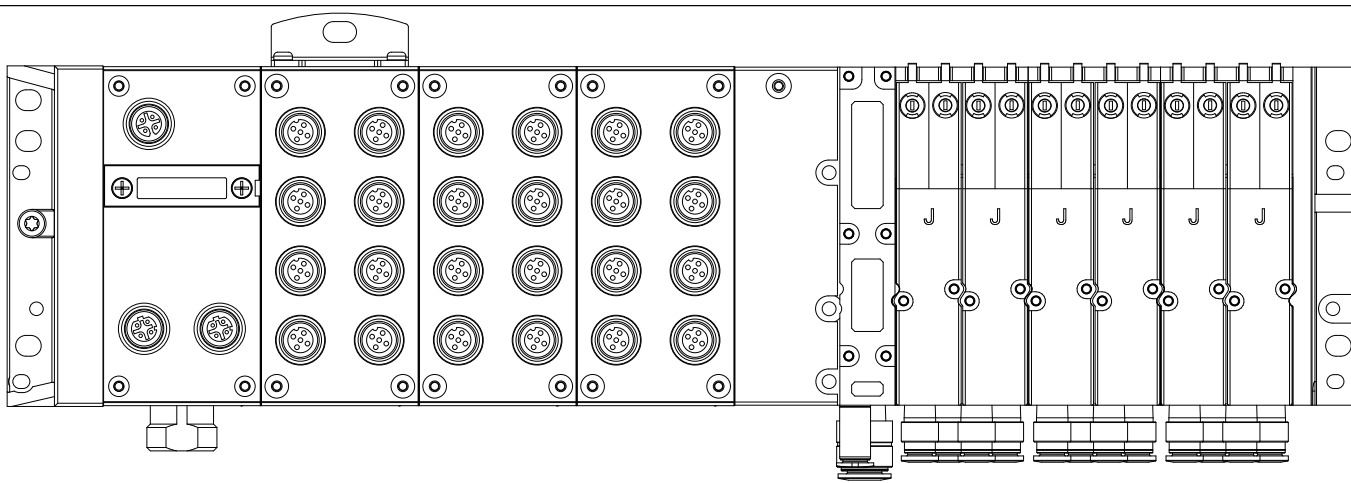

1

11

		Date	9/30/2022	Volvo Trucks North America		Valiant TMS	AIR SUPPLY	Drawing name:		= V1AR12UQ42KF1			
		Ed.	MKLEPADLO					Document type:		Project nr:		Page 5	
		Appr		P6700 Underbody Floor Skin - Cell 2V03		Scale 1:1		MFS		22-16151		176	
Modification	Date	Name	Original	Replacement of	Replaced by								

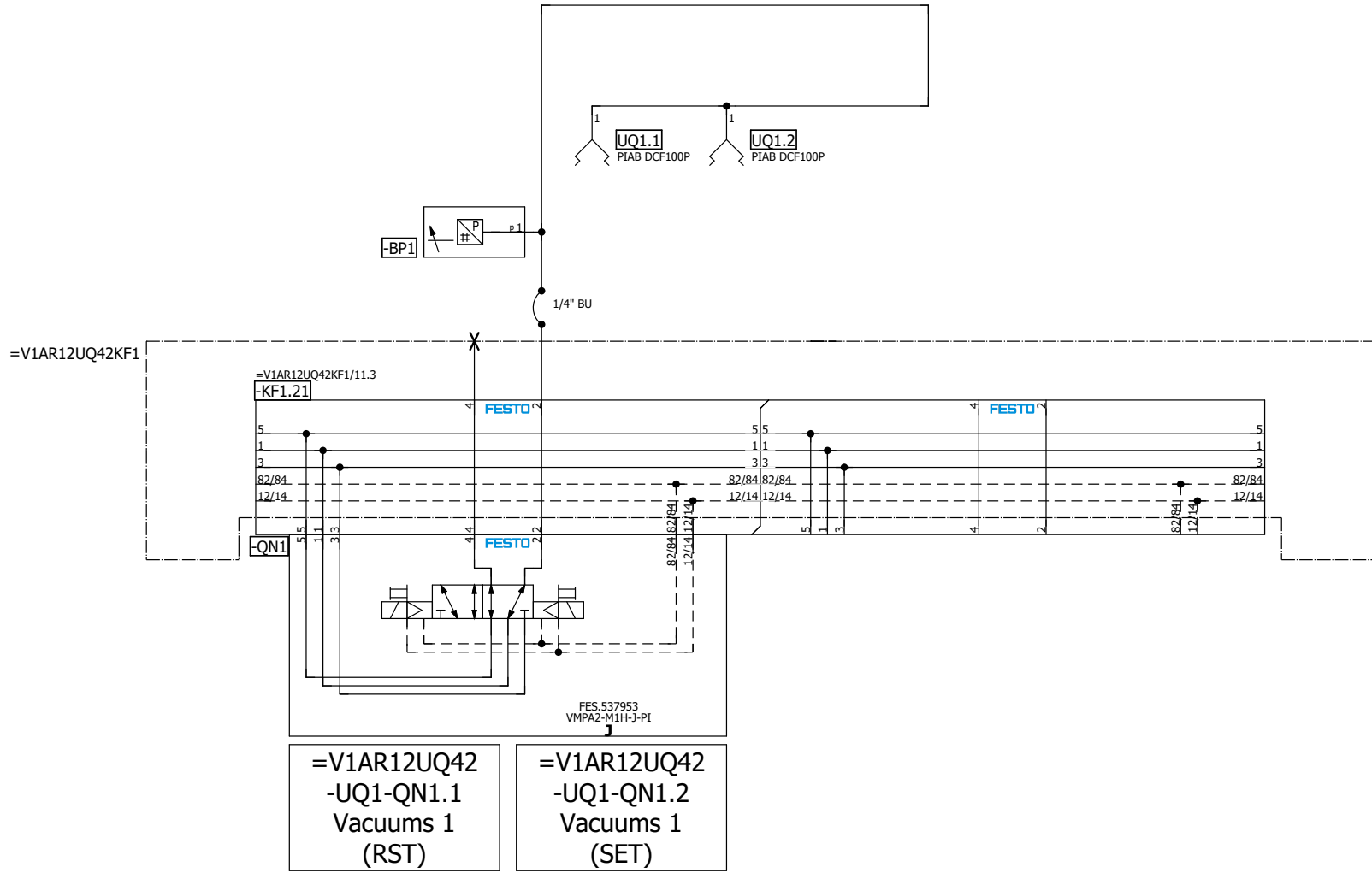

=V1AR12UQ42KF1/11

		Date	11/4/2022	Volvo Trucks North America		Valiant TMS		Vacuums 1		Drawing name: = 2V03&MFS-PNEU		= V1AR12UQ42UQ1 + V1AR12UQ42	
		Ed.	KMAFFRE			Scale 1:1				Document type: MFS		Project nr: 22-16151	
		Appr		P6700 Underbody Floor Skin - Cell 2V03						Page		1	
Modification	Date	Name	Original	Replacement of		Replaced by				Page		176	

=V1AR12UQ42UQ2/1

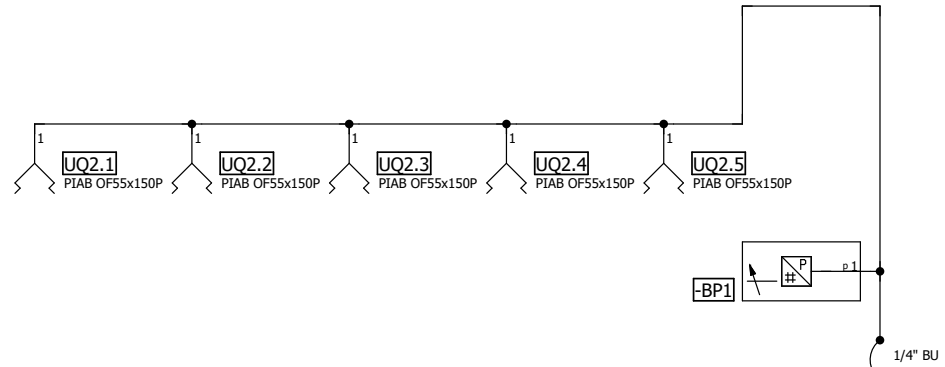

=V1AR12UQ42KF1

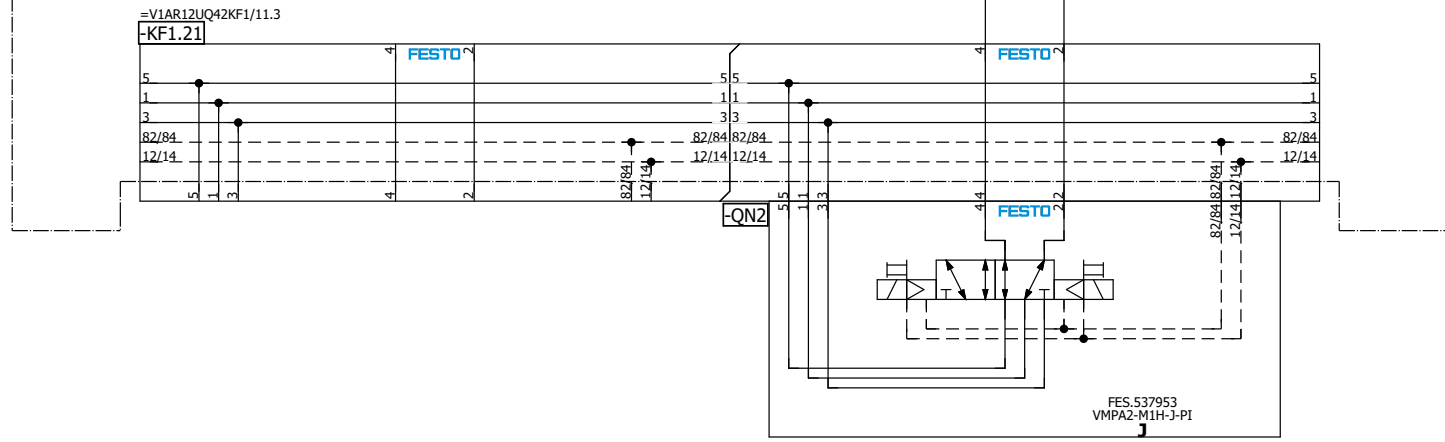

=V1AR12UQ42
-UQ2-QN2.1
Vacuums 2
(RST)

=V1AR12UQ42
-UQ2-QN2.2
Vacuums 2
(SET)

=V1AR12UQ42UQ3/1

=V1AR12UQ42UQ1/1

		Date	11/4/2022	Volvo Trucks North America		Valiant TMS		Vacuums 2		Drawing name: = 2V03&MFS-PNEU		= V1AR12UQ42UQ2 + V1AR12UQ42	
		Ed.	KMAFFRE	P6700 Underbody Floor Skin - Cell 2V03		Scale 1:1				Document type: MFS		Project nr: 22-16151	
Modification	Date	Name	Original	Replacement of	Replaced by							Page	1
												176	

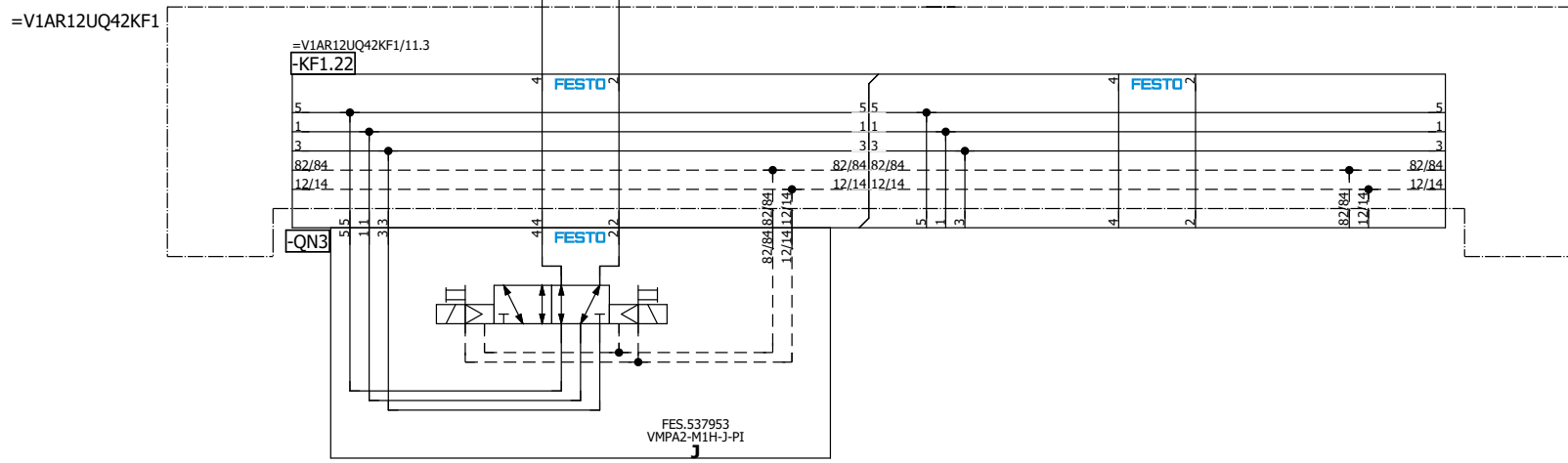
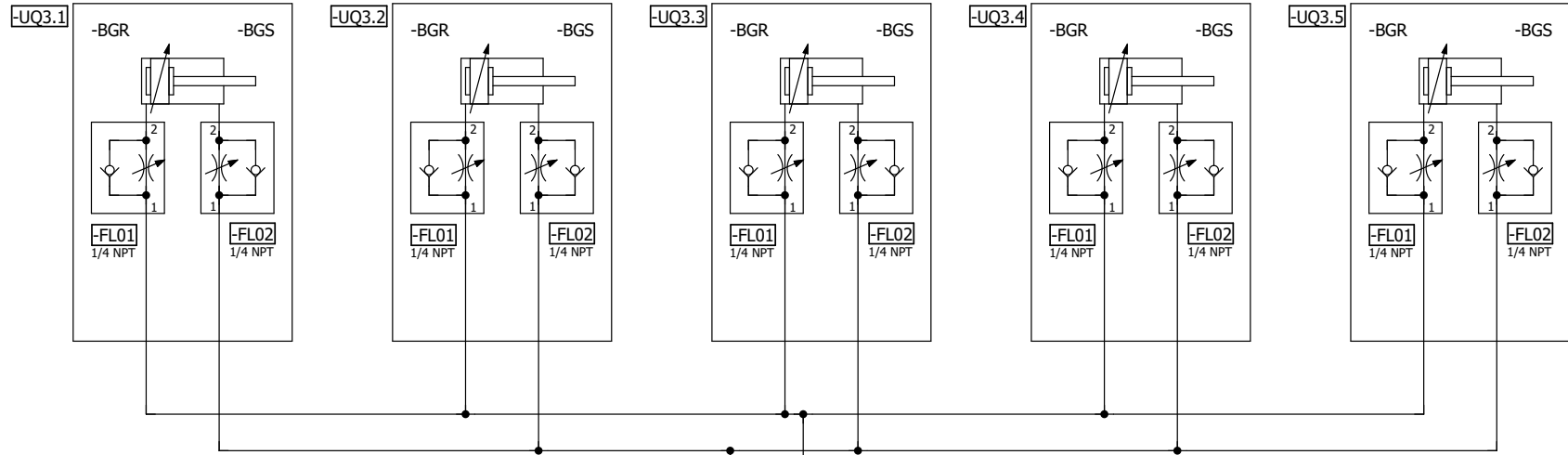

=V1AR12UQ42
-UQ3-QN3.1
Clamps 1
(RST)

=V1AR12UQ42
-UQ3-QN3.2
Clamps 1
(SET)

=V1AR12UQ42UQ4/1

		Date	11/4/2022	Volvo Trucks North America	Valiant TMS	Clamps 1	Drawing name:	= V1AR12UQ42UQ3	
		Ed.	KMAFFRE				= 2V03&MFS-PNEU	+ V1AR12UQ42	
		Appr		P6700 Underbody Floor Skin - Cell 2V03			Document type:	Project nr:	
Modification	Date	Name	Original	Replacement of	Replaced by	Scale 1:1	MFS	22-16151	
								Page	1
									176

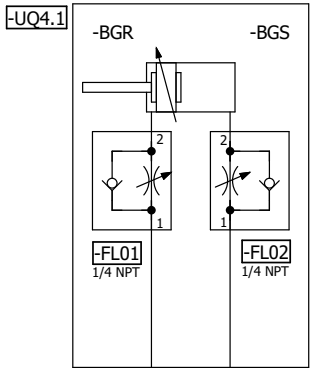

=V1AR12UQ42KF1

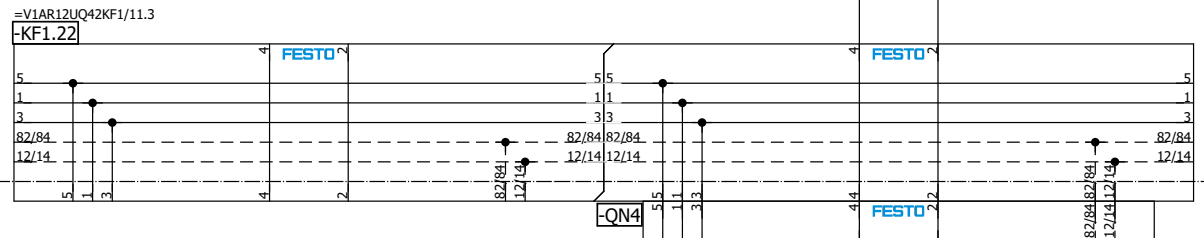

1/4" BU

1/4" BU

=V1AR12UQ42
-UQ4-QN4.1
Shot Pin
(RST)

=V1AR12UQ42
-UQ4-QN4.2
Shot Pin
(SET)

=V1AR12UQ42UQ5/1

=V1AR12UQ42UQ3/1

			Date	11/4/2022	Volvo Trucks North America		Valiant TMS	Shot Pin	Drawing name:		= V1AR12UQ42UQ4			
			Ed.	KMAFFRE					= 2V03&MFS-PNEU		+ V1AR12UQ42			
			Appr		P6700 Underbody Floor Skin - Cell 2V03		Scale 1:1	Document type:		MFS	Project nr:	22-16151	Page	1
Modification	Date	Name	Original		Replacement of	Replaced by								

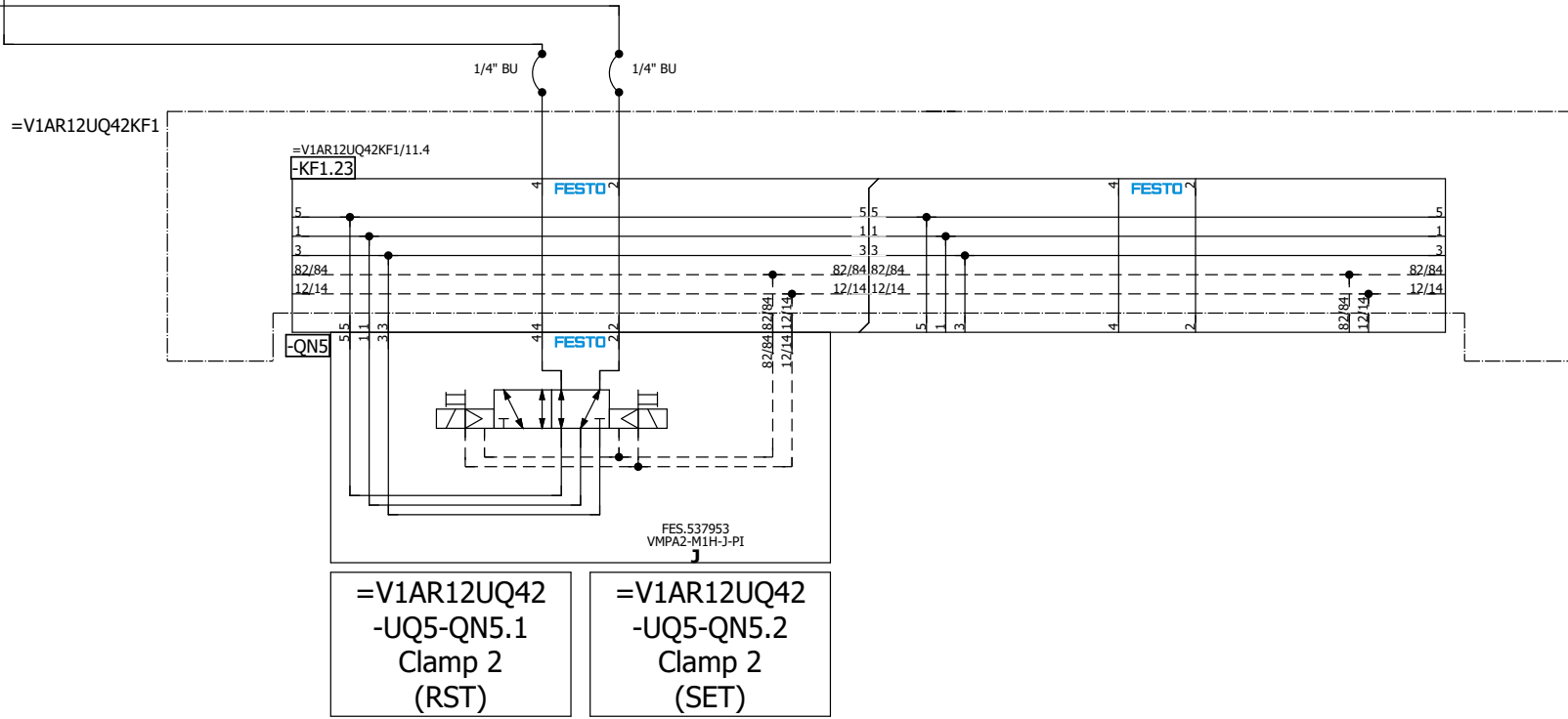
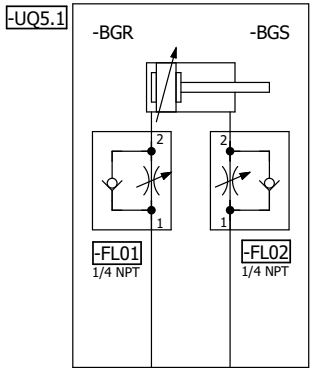

=V1AR12UQ42UQ4/1

=V1AR12UQ42UQ6/1

Date	11/4/2022	Volvo Trucks North America	Valiant TMS	Clamp 2	Drawing name:	= 2V03&MFS-PNEU	= V1AR12UQ42UQ5
Ed.	KMAFFRE	P6700 Underbody Floor Skin - Cell 2V03	Scale 1:1	Document type:	MFS	Project nr:	22-16151
Appr							
Modification	Date	Name	Original				

=V1AR12UQ42KF1

=V1AR12UQ42KF1/11.4
-KF1.23

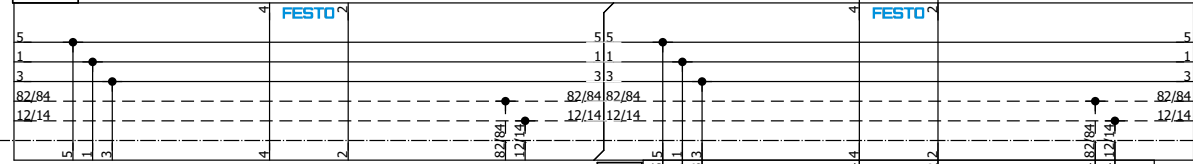

-QN6

=V1AR12UQ42
-UQ6-QN6.1
Spare
(RST)

=V1AR12UQ42
-UQ6-QN6.2
Spare
(SET)

FES.537953
VMPA2-M1H-J-PI

=V1AR13UQ41KF1+.AR13UQ41/1

=V1AR12UQ42UQ5/1

		Date	9/30/2022	Volvo Trucks North America			Valiant TMS	Spare	Drawing name: = 2V03&MFS-PNEU		= V1AR12UQ42UQ6 + V1AR12UQ42	
		Ed.	MKLEPADLO	P6700 Underbody Floor Skin - Cell 2V03			Scale 1:1		Document type: MFS	Project nr: 22-16151	Page 1	176
Modification	Date	Name	Original	Replacement of	Replaced by							

M1

M2

M3

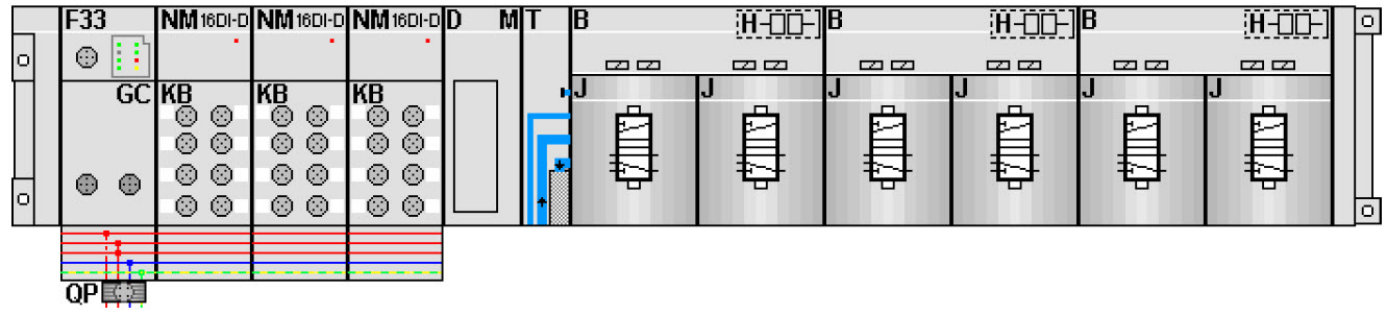

KF2.0

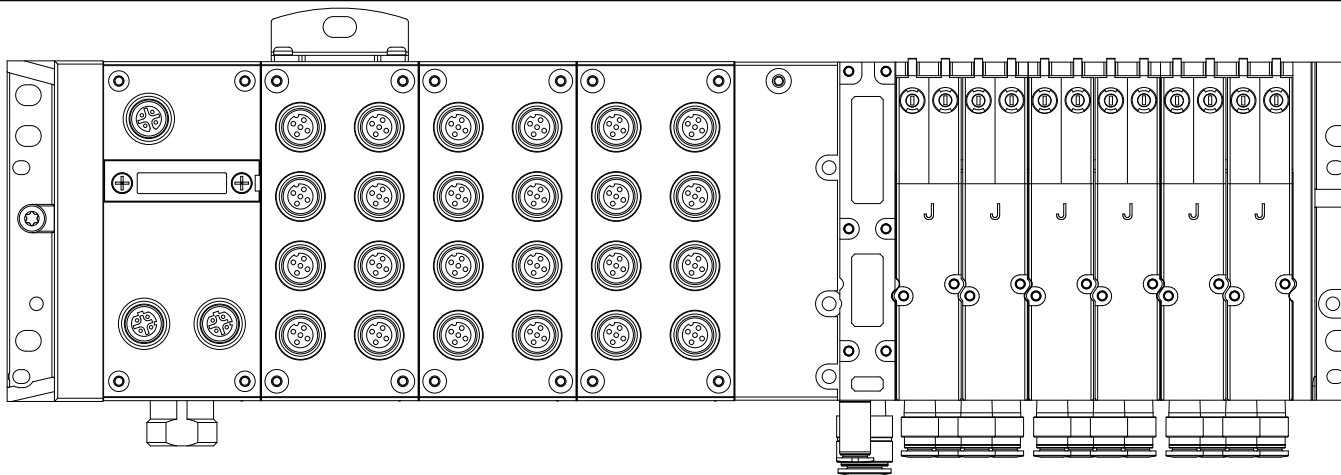

=V1AR13UQ41KF1/11

		Date	9/30/2022	Volvo Trucks North America		Valiant TMS	AIR SUPPLY	Drawing name:		= V1AR13UQ41KF2	
		Ed.	MKLEPADLO					= 2V03&MFS-PNEU		+ V1AR13UQ41	
		Appr		P6700 Underbody Floor Skin - Cell 2V03		Scale 1:1		Document type:		Project nr:	
Modification	Date	Name	Original	Replacement of	Replaced by			MFS	22-16151		Page
										176	

M1

M2

M3

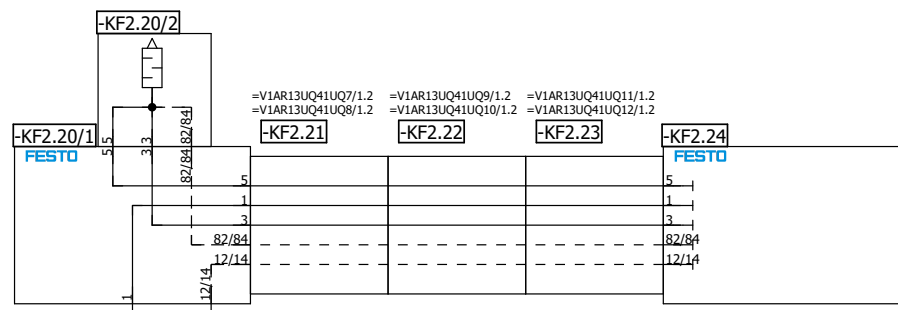
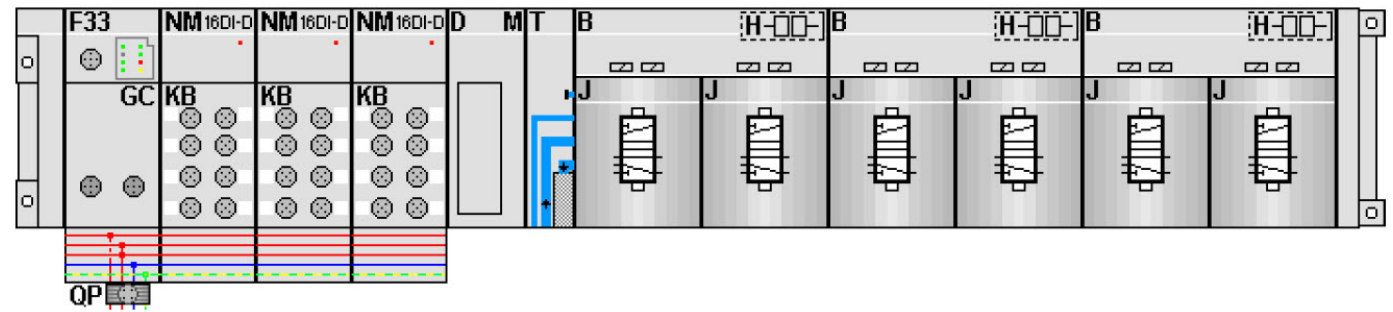

=V1AR13UQ41KF1/1.4 / P2 → 1/2"

=V1AR13UQ41UQ1/1

		Date	11/11/2022	Volvo Trucks North America		Valiant TMS	AIR SUPPLY	Drawing name:		= 2V03&MFS-PNEU	= V1AR13UQ41KF2	
		Ed.	KMAFFRE					Document type:		MFS	Project nr:	22-16151
Modification	Date	Name	Original	Replacement of		Replaced by	Scale	1:1			Page	176

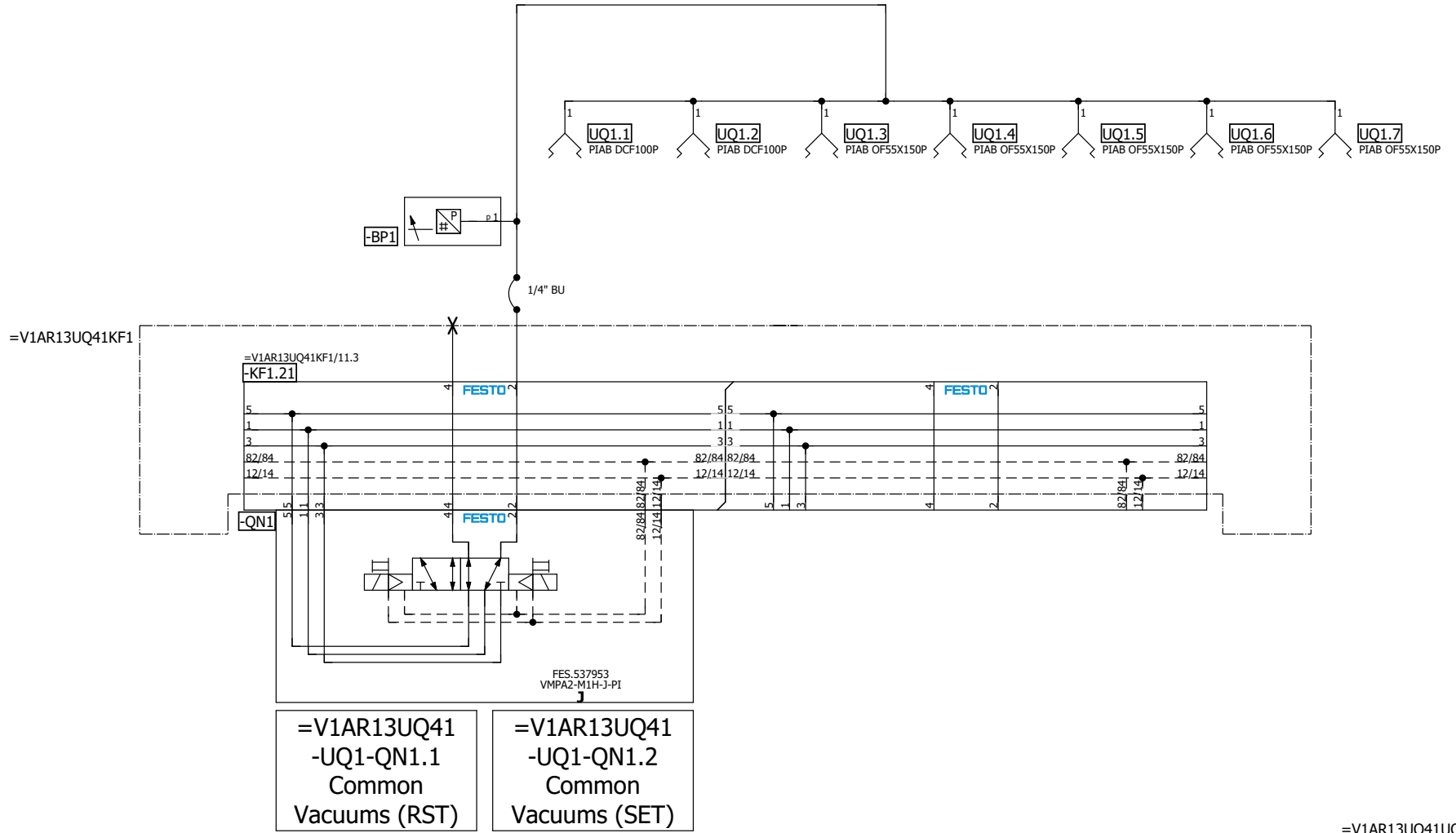

=V1AR13UQ41KF2/11

=V1AR13UQ41UQ2/1

Date	11/4/2022	Volvo Trucks North America	Valiant TMS	Common Vacuums	Drawing name:	= 2V03&MFS-PNEU	= V1AR13UQ41UQ1
Ed.	KMAFFRE	P6700 Underbody Floor Skin - Cell 2V03	Scale 1:1		Document type:	MFS	+ V1AR13UQ41
Appr					Project nr:	22-16151	Page
Modification	Date	Name	Original	Replacement of	Replaced by		176

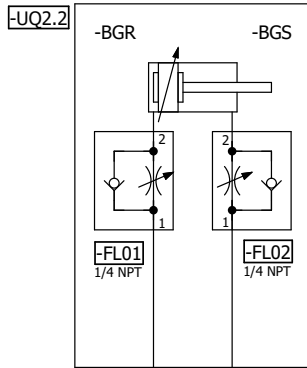
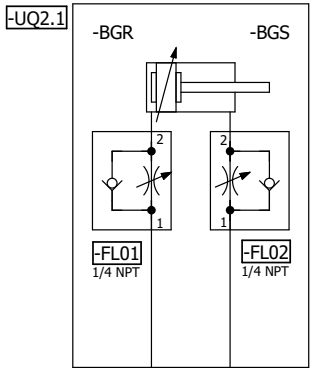

=V1AR13UQ41KF1

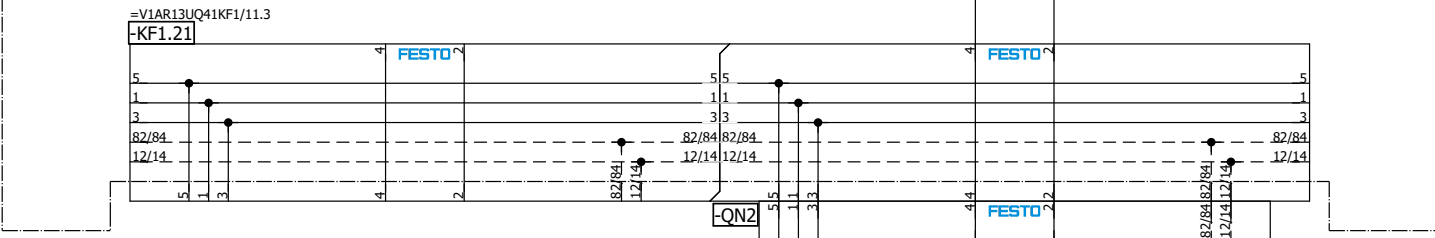

=V1AR13UQ41
-UQ2-QN2.1
Common
Clamps (RST)

=V1AR13UQ41
-UQ2-QN2.2
Common
Clamps (SET)

FES.537953
VMPA2-M1H-J-PI

=V1AR13UQ41UQ1/1

=V1AR13UQ41UQ3/1

Date	11/4/2022	Volvo Trucks North America	Valiant TMS	Common Clamps	Drawing name:	= 2V03&MFS-PNEU	= V1AR13UQ41UQ2
Ed.	KMAFFRE	P6700 Underbody Floor Skin - Cell 2V03	Scale 1:1		Document type:	MFS	+ V1AR13UQ41
Appr					Project nr:	22-16151	Page
Modification	Date	Name	Original	Replacement of	Replaced by		176

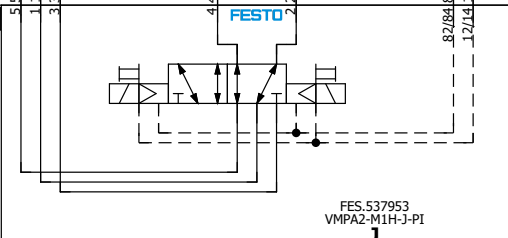
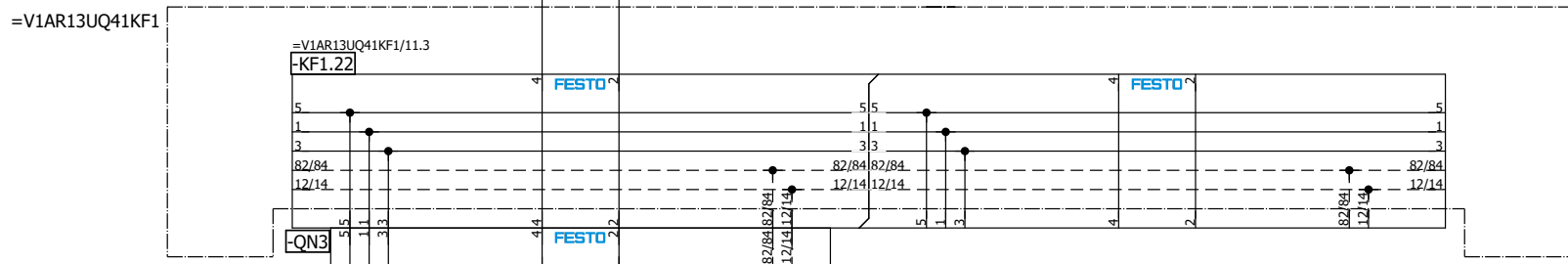
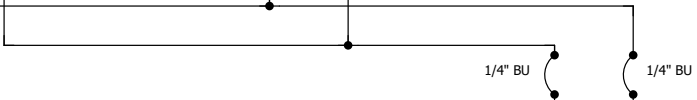
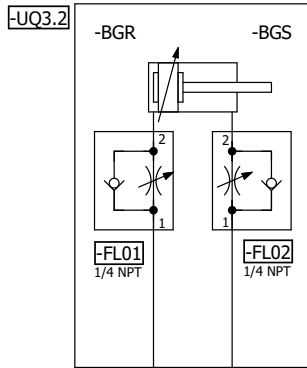
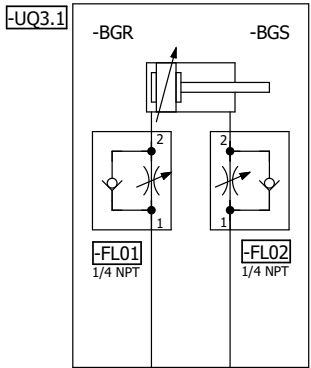

=V1AR13UQ41
-UQ3-QN3.1
L150 Model
Clamps (RST)

=V1AR13UQ41
-UQ3-QN3.2
L150 Model
Clamps (SET)

=V1AR13UQ41UQ2/1

=V1AR13UQ41UQ4/1

Date	11/4/2022	Volvo Trucks North America	Valiant TMS	L150 Model Clamps	Drawing name:	= 2V03&MFS-PNEU	= V1AR13UQ41UQ3
Ed.	KMAFFRE				Document type:	MFS	+ V1AR13UQ41
Appr		P6700 Underbody Floor Skin - Cell 2V03			Project nr:	22-16151	Page 1
Modification	Date	Name	Original	Replacement of	Replaced by	Scale 1:1	176

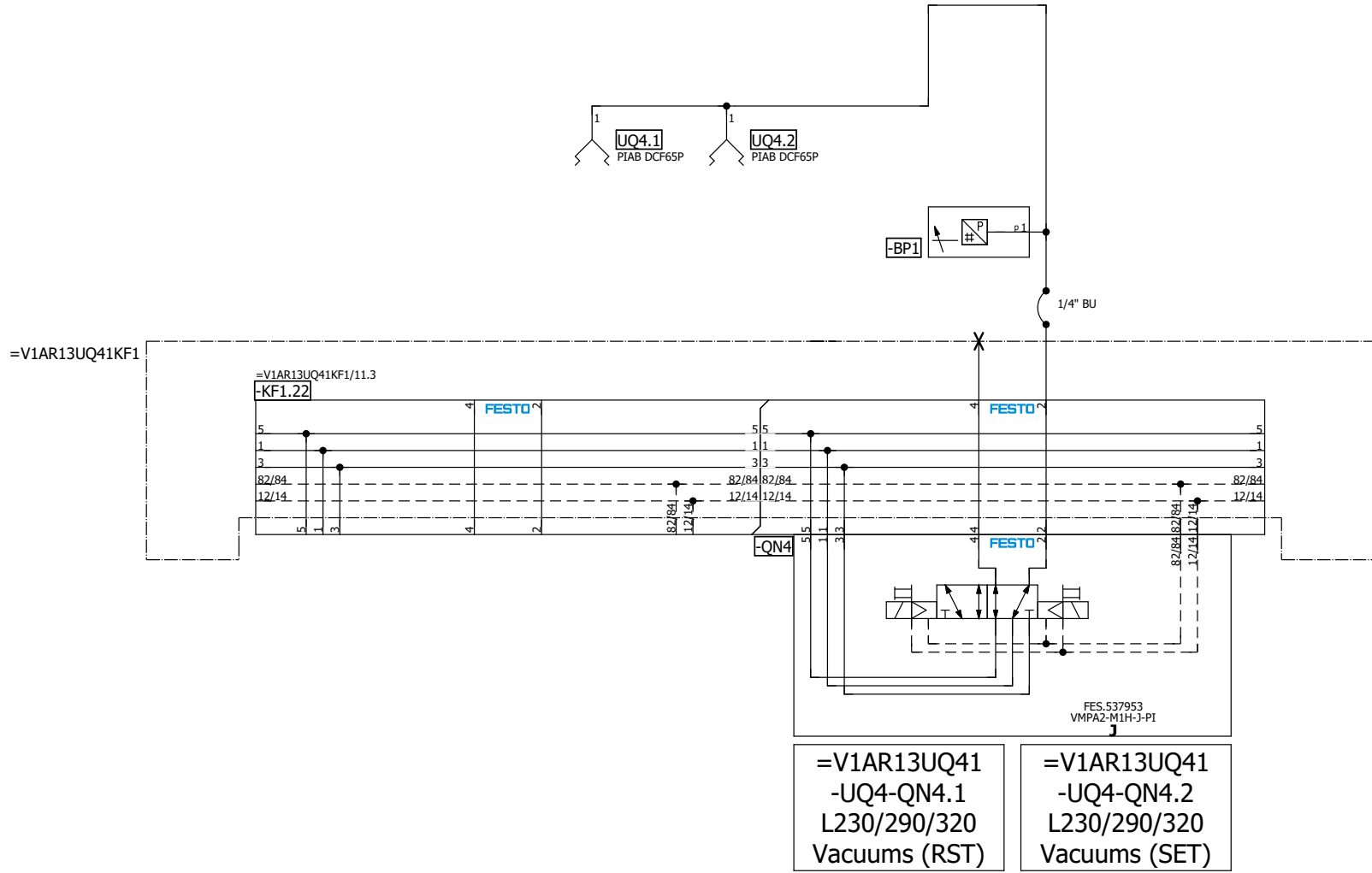

=V1AR13UQ41UQ3/1

=V1AR13UQ41UQ5/1

Date	11/4/2022	Volvo Trucks North America	Valiant TMS	L230/290/320 Model Vacuums	Drawing name:	=V1AR13UQ41UQ4
Ed.	KMAFFRE				=2V03&MFS-PNEU	+ V1AR13UQ41
Appr		P6700 Underbody Floor Skin - Cell 2V03			Document type:	MFS
Original		Replacement of	Replaced by	Scale 1:1	Project nr:	22-16151
Modification	Date	Name	Original			Page 1
						176

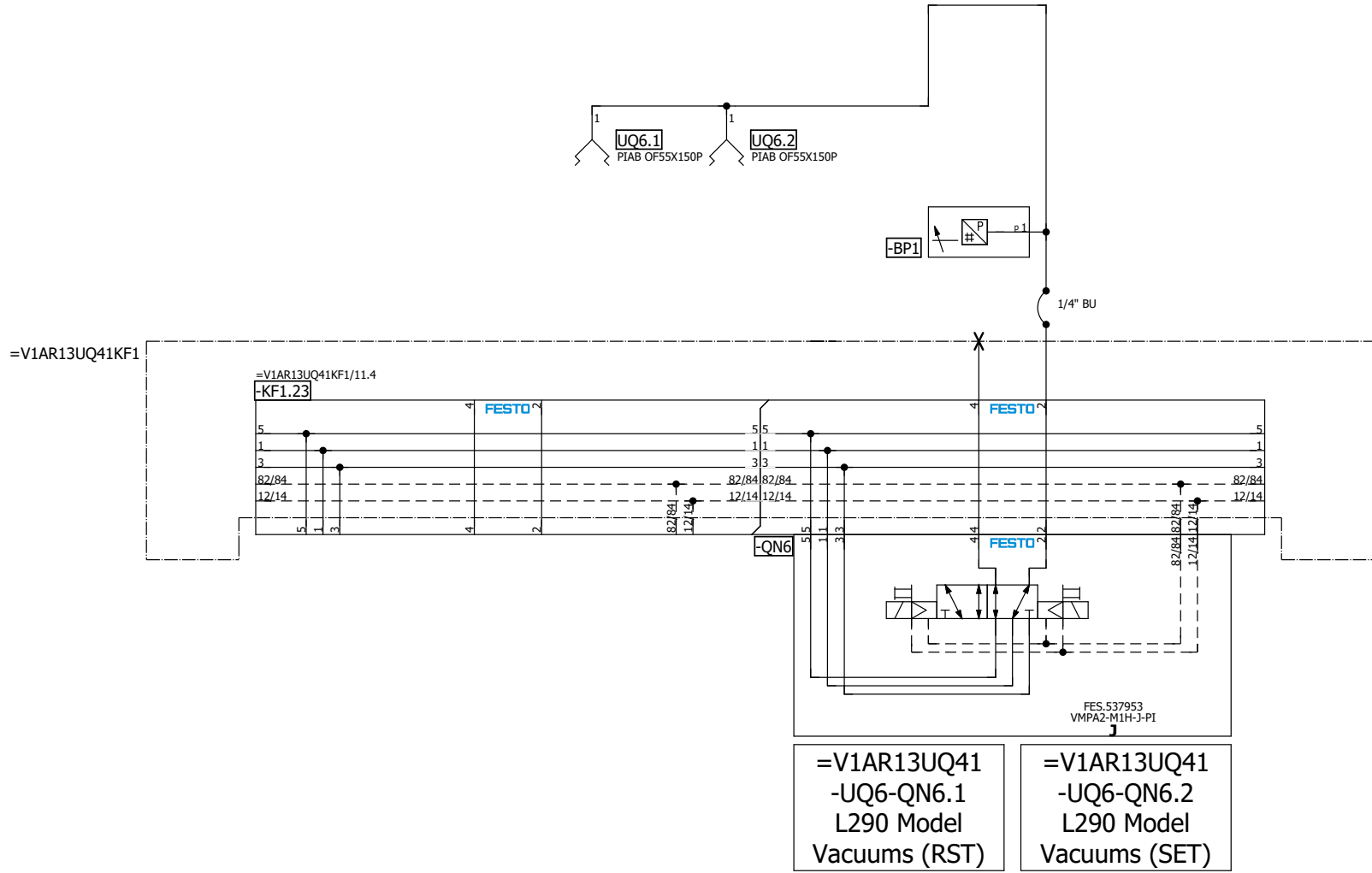

=V1AR13UQ41UQ5/1

=V1AR13UQ41UQ7/1

Date		11/4/2022	Volvo Trucks North America		Valiant TMS	L290 Model Vacuums	Drawing name:		= V1AR13UQ41UQ6	
Ed.		KMAFFRE					= 2V03&MFS-PNEU		+ V1AR13UQ41	
Appr			P6700 Underbody Floor Skin - Cell 2V03		Scale 1:1	Document type:		MFS	Project nr: 22-16151	
Modification	Date	Name	Original	Replacement of		Replaced by	Page			1
								Page		176

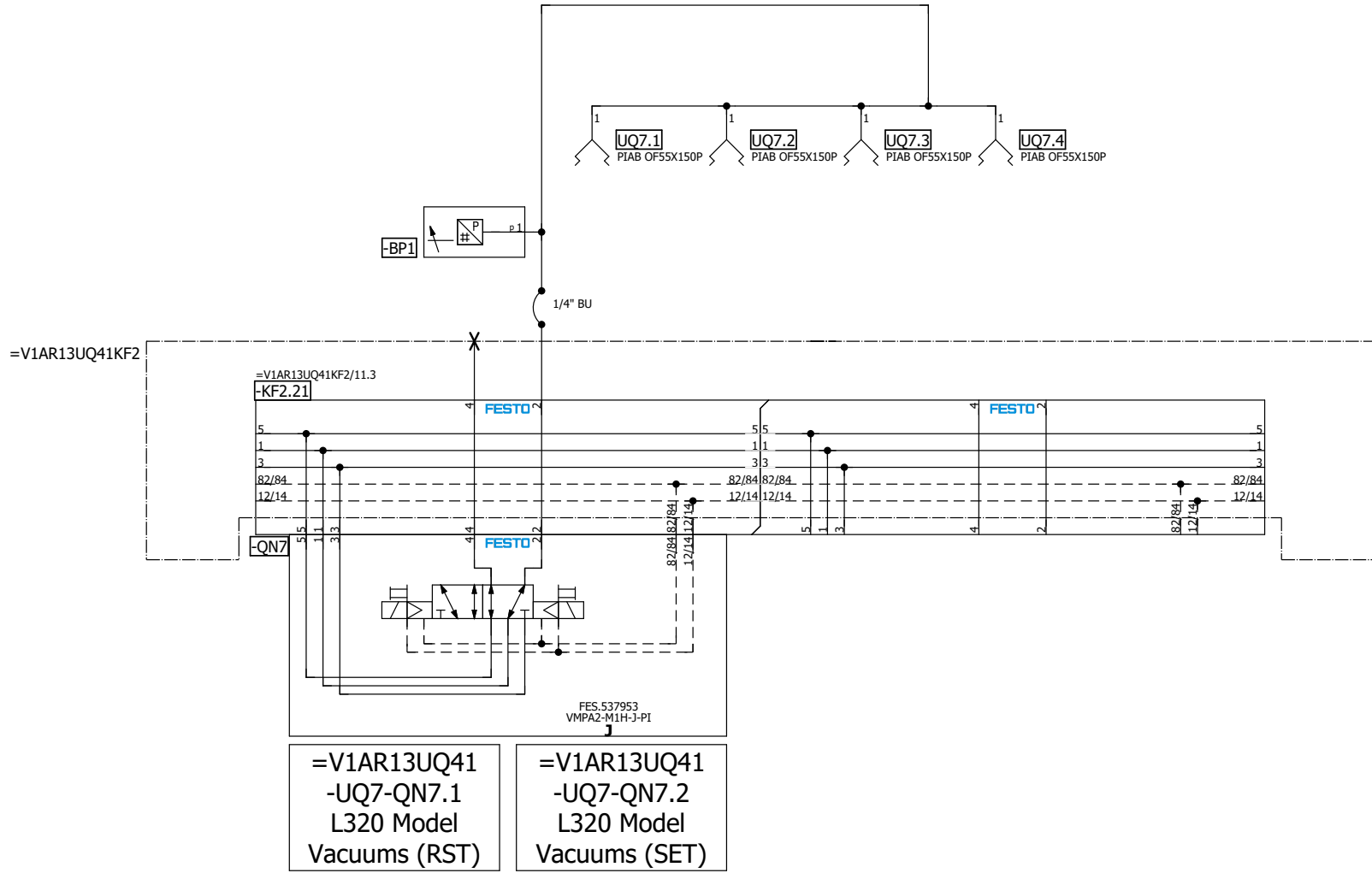

=V1AR13UQ41UQ6/1

Date	11/4/2022
Ed.	KMAFFRE
Appr	
Original	

Volvo Trucks North America
 P6700 Underbody Floor Skin - Cell 2V03
 Replacement of Replaced by

Valiant TMS
 Scale 1:1

L320 Model Vacuums

Drawing name:
 = 2V03&MFS-PNEU
 Document type: MFS
 Project nr: 22-16151

= V1AR13UQ41UQ7
 + V1AR13UQ41
 Page 1
 176

=V1AR13UQ41
 -UQ7-QN7.1
 L320 Model
 Vacuums (RST)

=V1AR13UQ41
 -UQ7-QN7.2
 L320 Model
 Vacuums (SET)

=V1AR13UQ41UQ8/1

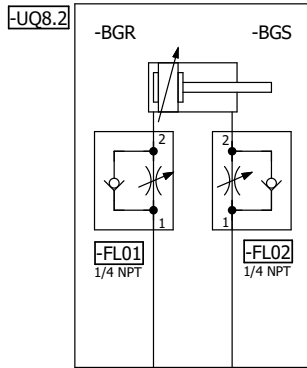
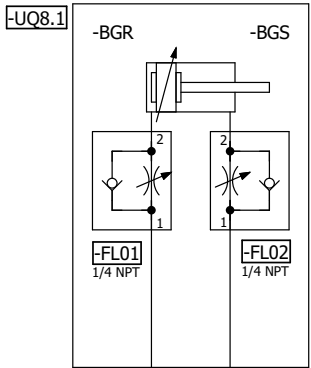

=V1AR13UQ41KF2

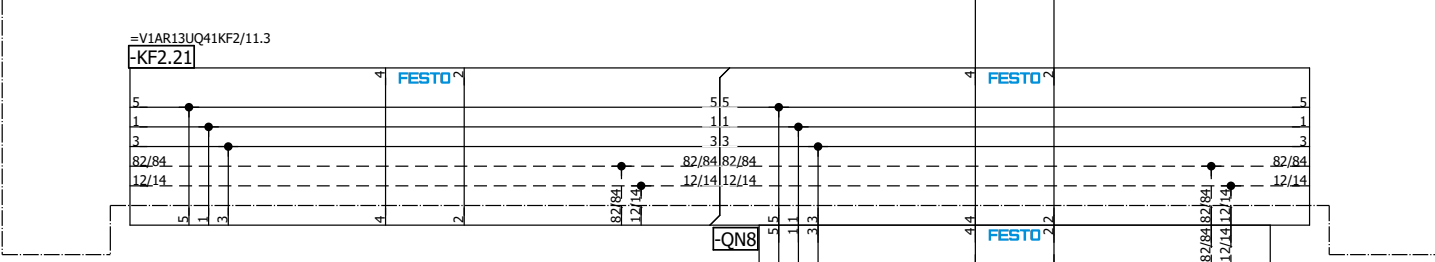

=V1AR13UQ41
-UQ8-QN8.1
L230 Model
Clamps (RST)

=V1AR13UQ41
-UQ8-QN8.2
L230 Model
Clamps (SET)

FES.537953
VMPA2-M1H-J-PI

=V1AR13UQ41UQ7/1

=V1AR13UQ41UQ9/1

Date	11/4/2022	Volvo Trucks North America	Valiant TMS	L230 Model Clamps	Drawing name:	= V1AR13UQ41UQ8
Ed.	KMAFFRE				= 2V03&MFS-PNEU	+ V1AR13UQ41
Appr		P6700 Underbody Floor Skin - Cell 2V03			Document type:	MFS
Modification	Date	Name	Original	Replacement of	Replaced by	Scale 1:1
						Project nr:
						22-16151
						Page
						1
						176

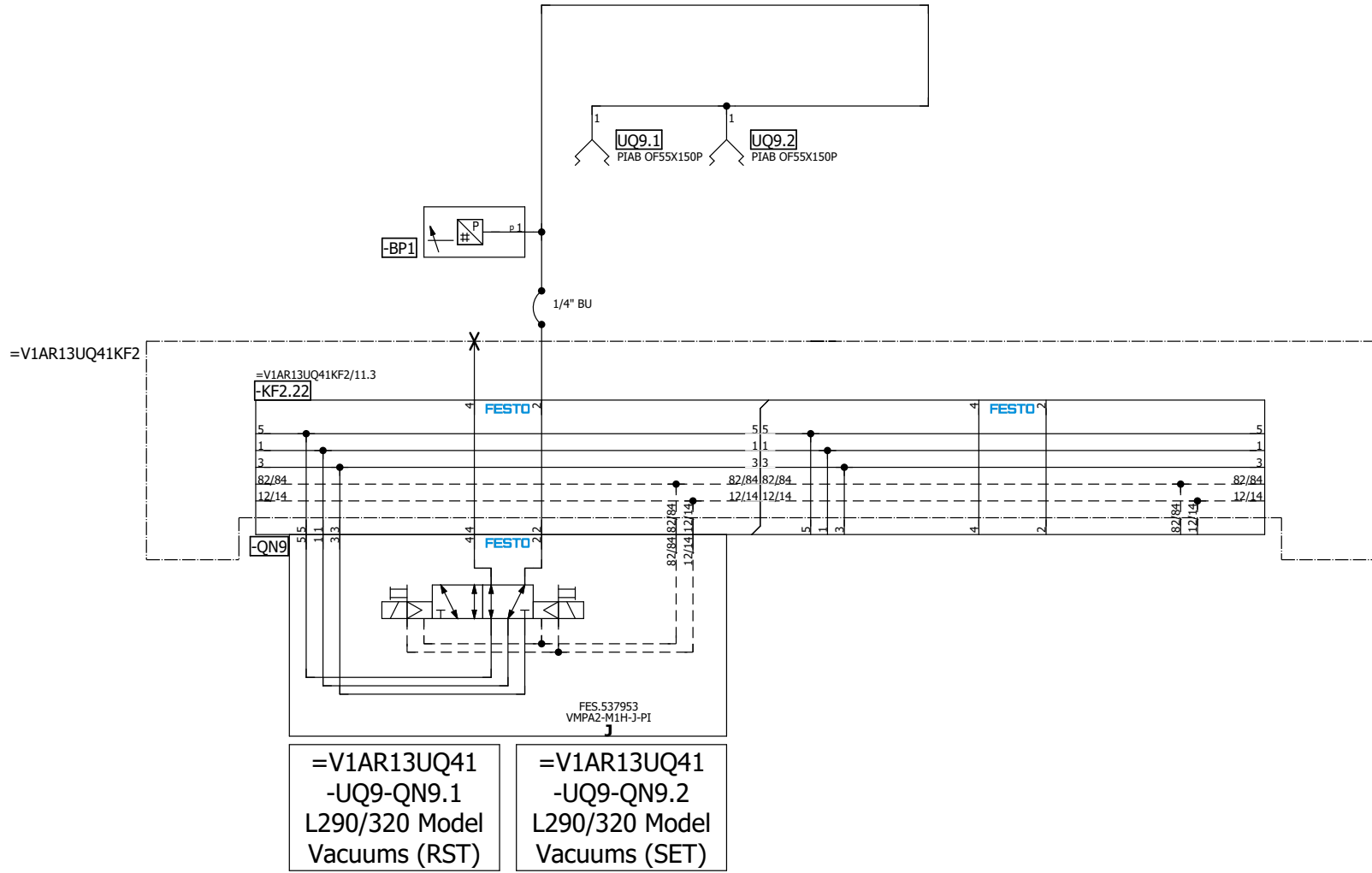

=V1AR13UQ41UQ8/1

=V1AR13UQ41UQ10/1

Date	11/4/2022	Volvo Trucks North America	Valiant TMS	L290/320 Model Vacuums	Drawing name:	= 2V03&MFS-PNEU	= V1AR13UQ41UQ9
Ed.	KMAFFRE	P6700 Underbody Floor Skin - Cell 2V03	Scale 1:1		Document type:	MFS	+ V1AR13UQ41
Appr					Project nr:	22-16151	Page
Modification	Date	Name	Original	Replacement of	Replaced by		176

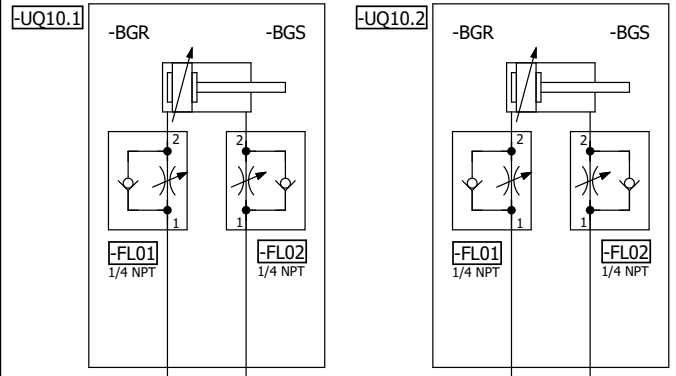

=V1AR13UQ41KF2

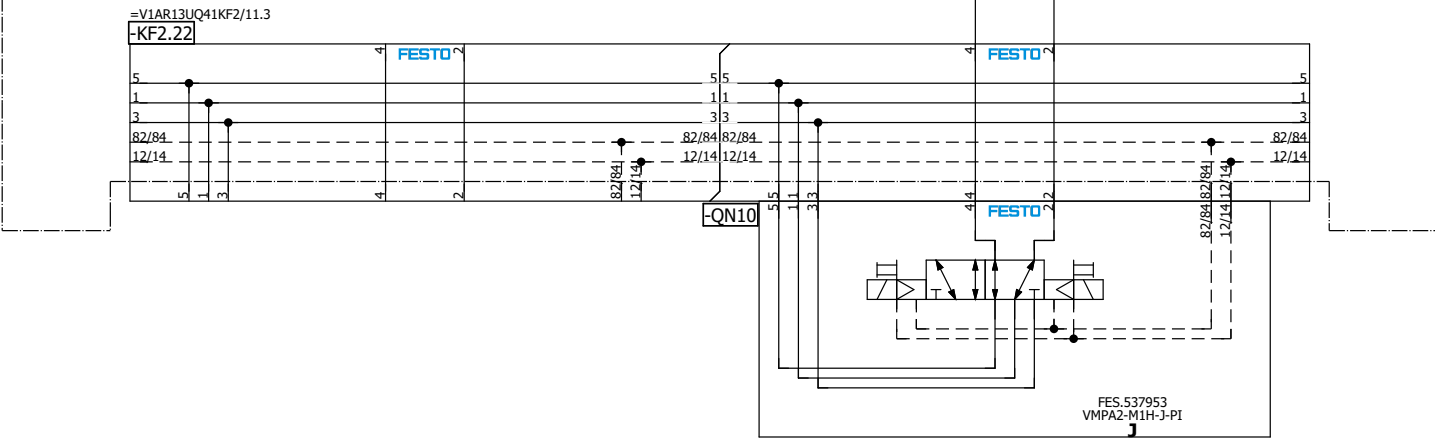

=V1AR13UQ41
-UQ10-QN10.1
L290 Model
Clamps (RST)

=V1AR13UQ41
-UQ10-QN10.2
L290 Model
Clamps (SET)

=V1AR13UQ41UQ11/1

			Date	11/4/2022	Volvo Trucks North America		Valiant TMS	L290 Model Clamps	Drawing name:		= V1AR13UQ41UQ10	
			Ed.	KMAFFRE					= 2V03&MFS-PNEU		+ V1AR13UQ41	
			Appr		P6700 Underbody Floor Skin - Cell 2V03		Scale 1:1	Document type:		MFS	Project nr: 22-16151	Page 1
Modification	Date	Name	Original		Replacement of	Replaced by		FES.537953 VMPA2-M1H-J-PI		= V1AR13UQ41UQ11/1		

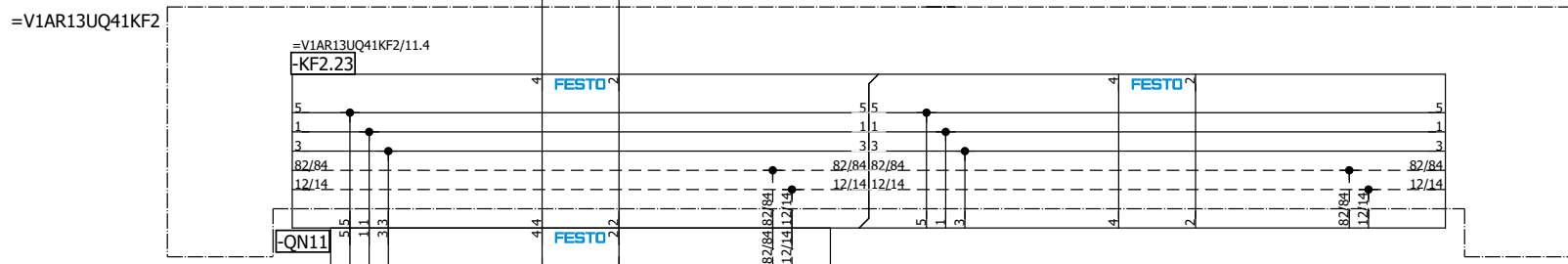
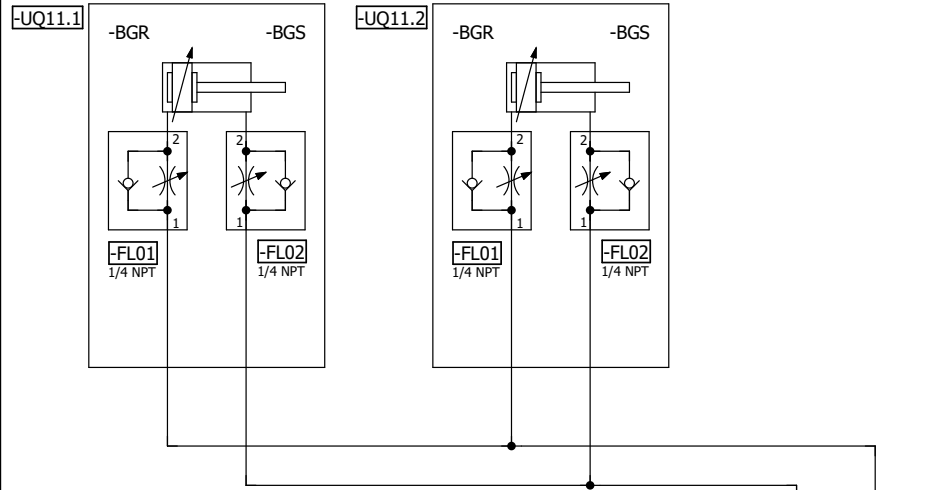

=V1AR13UQ41
-UQ11-QN11.1
L320 Model
Clamps (RST)

=V1AR13UQ41
-UQ11-QN11.2
L320 Model
Clamps (SET)

=V1AR13UQ41UQ10/1

=V1AR13UQ41UQ12/1

Date	11/4/2022	Volvo Trucks North America	Valiant TMS	L320 Model Clamps	Drawing name:	= 2V03&MFS-PNEU	= V1AR13UQ41UQ11
Ed.	KMAFFRE				Document type:	MFS	+ V1AR13UQ41
Appr		P6700 Underbody Floor Skin - Cell 2V03			Project nr:	22-16151	Page 1
Modification	Date	Name	Original	Replacement of	Replaced by	Scale 1:1	176

=V1AR13UQ41KF2

=V1AR13UQ41KF2/11.4
-KF2.23

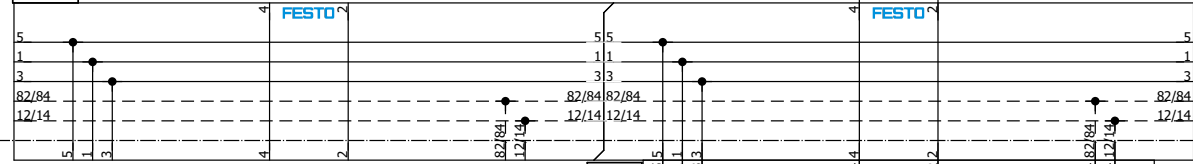

-QN12

=V1AR13UQ41
-UQ12-QN12.1
Spare
(RST)

=V1AR13UQ41
-UQ12-QN12.2
Spare
(SET)

FES.537953
VMPA2-M1H-J-PI

=V1GL12+KH1/1

=V1AR13UQ41UQ11/1

		Date	9/30/2022	Volvo Trucks North America		Valiant TMS		Spare		Drawing name: = 2V03&MFS-PNEU		= V1AR13UQ41UQ12	
		Ed.	MKLEPADLO			Scale 1:1				Document type: MFS		+ V1AR13UQ41	
		Appr		P6700 Underbody Floor Skin - Cell 2V03						Project nr: 22-16151		Page 1	
Modification	Date	Name	Original	Replacement of	Replaced by							176	



A2

=KH0+KH0/1.7 / +V1GL12KH1-P1

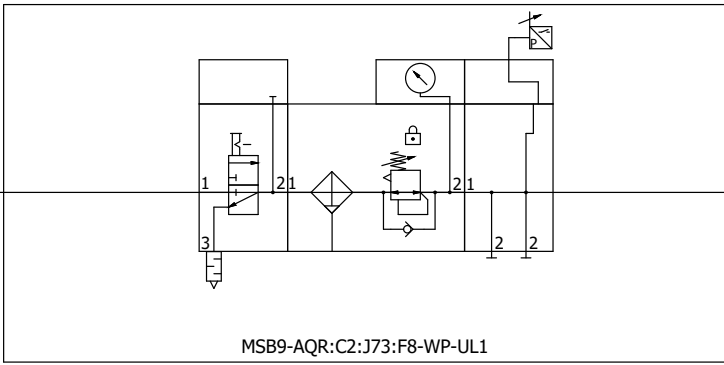

MSB9-AQR:C2:J73:F8-WP-UL1

1/2"

+V1GL12UQ51-P1 / =V1GL12UQ51KF1+V1GL12UQ51/11.0

=V1AR13UQ41UQ12+V1AR13UQ41/1

=V1GL12UQ51KF1+V1GL12UQ51/5

			Date	10/31/2022	Volvo Trucks North America	Valiant TMS	Incoming air supply (Fixture)	Drawing name:	= V1GL12	Page	1
			Ed.	KMAFFRE				= 2V03&MFS-PNEU	+ KH1		
			Appr		P6700 Underbody Floor Skin - Cell 2V03	Scale 1:1		Document type:	MFS	Project nr:	22-16151
Modification	Date	Name	Original		Replacement of		Replaced by				

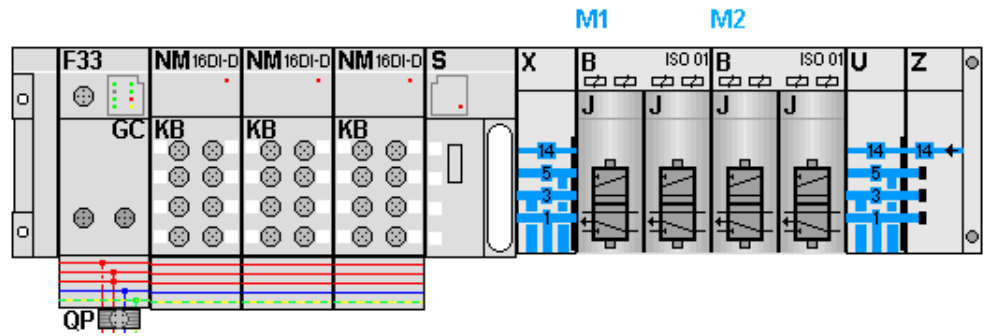

KF1.0

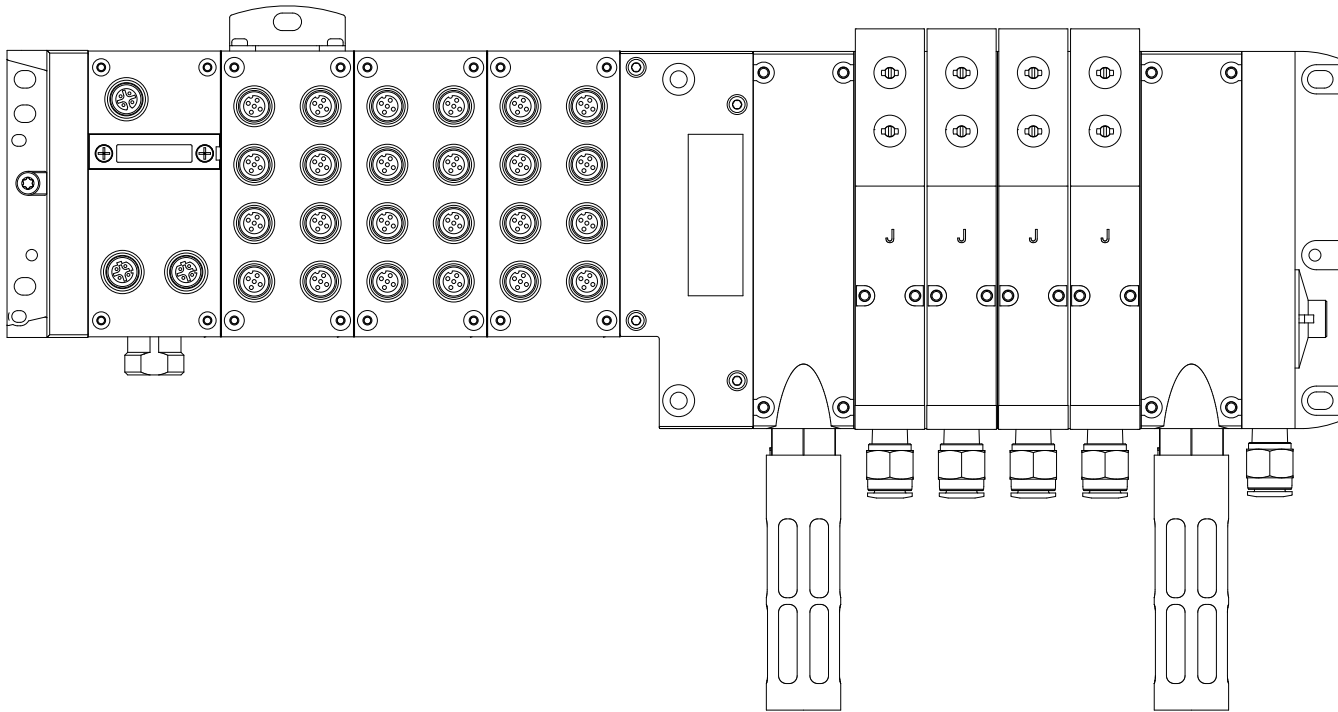

=V1GL12+KH1/1

		Date	9/30/2022	Volvo Trucks North America		Valiant TMS	AIR SUPPLY CONFIGURATION	Drawing name:		= V1GL12UQ51KF1			
		Ed.	MKLEPADLO					= 2V03&MFS-PNEU		+ V1GL12UQ51			
		Appr		P6700 Underbody Floor Skin - Cell 2V03		Scale 1:1	Document type:		MFS	Project nr:	22-16151	Page	5
Modification	Date	Name	Original	Replacement of	Replaced by							Page	176

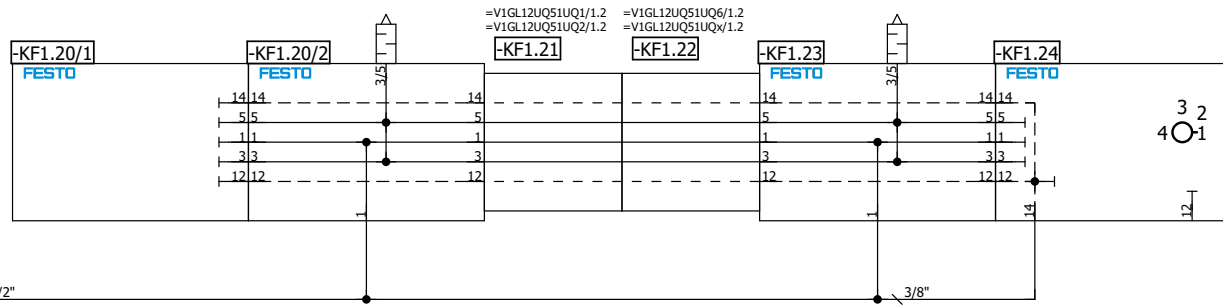
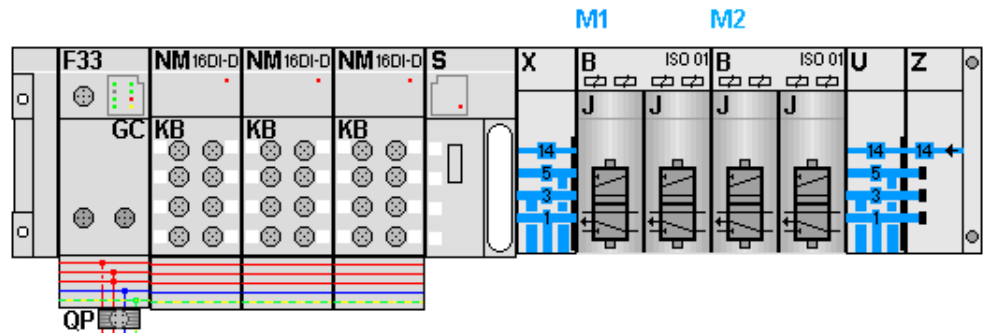

5

=V1GL12UQ51UQ1/1

Date		9/30/2022		Volvo Trucks North America		Valiant TMS		AIR SUPPLY		Drawing name:		= V1GL12UQ51KF1	
Ed.		MKLEPADLO								= 2V03&MFS-PNEU		+ V1GL12UQ51	
Appr				P6700 Underbody Floor Skin - Cell 2V03		Scale 1:1				Document type:		Project nr:	
Modification		Date		Name		Original		Replacement of		Replaced by		22-16151	
										MFS		Page 11	
												176	

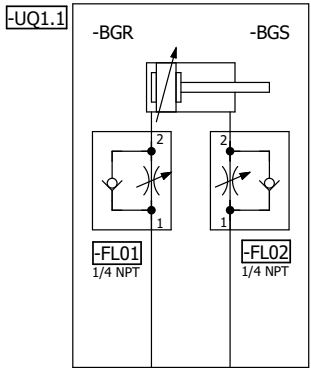

3/8" BU 3/8" BU

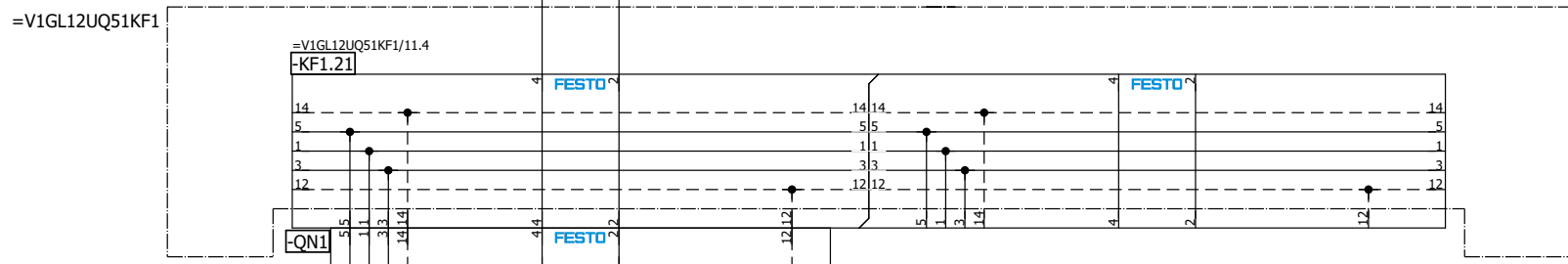

=V1GL12UQ51
-UQ1-QN1.1
Pallet Stop Sta #1
Load (RST)

=V1GL12UQ51
-UQ1-QN1.2
Pallet Stop Sta #1
Load (SET)

=V1GL12UQ51KF1/11

=V1GL12UQ51UQ2/1

Date	10/31/2022	Volvo Trucks North America	Valiant TMS	Pallet Stop Station #1 Load	Drawing name:	= 2V03&MFS-PNEU	= V1GL12UQ51UQ1
Ed.	KMAFFRE	P6700 Underbody Floor Skin - Cell 2V03	Scale 1:1		Document type:	MFS	+ V1GL12UQ51
Appr					Project nr:	22-16151	Page
Modification	Date	Name	Original	Replacement of	Replaced by		176

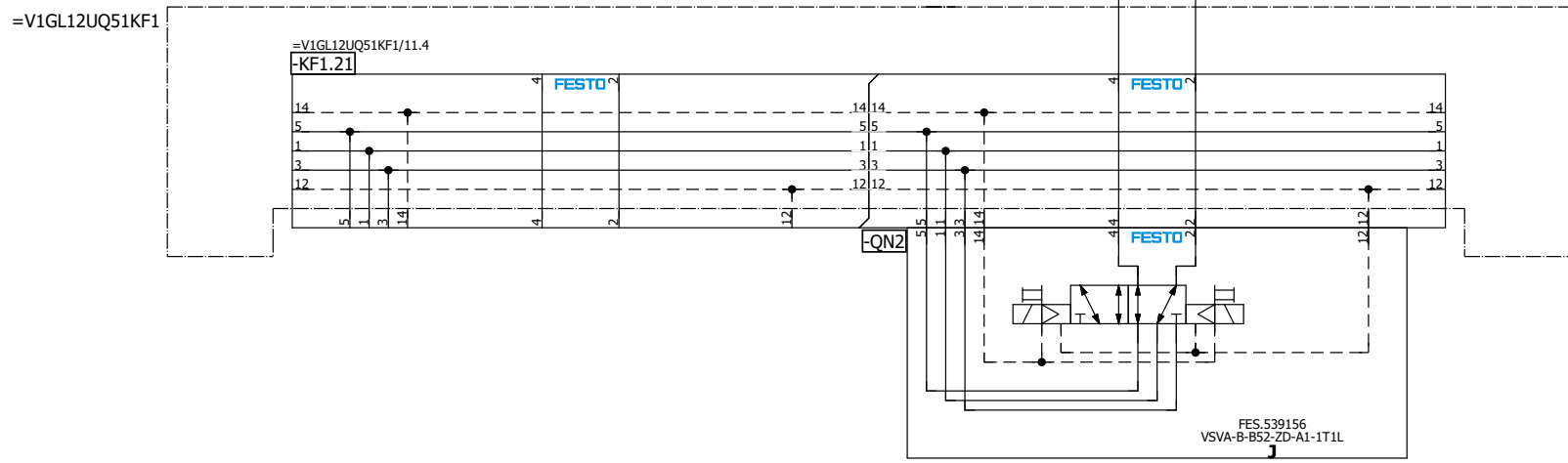
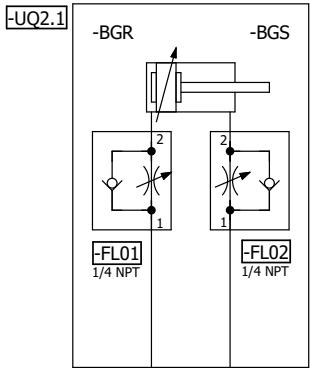

=V1GL12UQ51
-UQ2-QN2.1
Pallet Stop Sta #2
Mid-Stop (RST)

=V1GL12UQ51
-UQ2-QN2.2
Pallet Stop Sta #2
Mid-Stop (SET)

=V1GL12UQ51UQ1/1

=V1GL12UQ51UQ6/1

			Date	10/31/2022	Volvo Trucks North America	Valiant TMS	Pallet Stop Station #2 Mid-Stop	Drawing name:	= 2V03&MFS-PNEU	= V1GL12UQ51UQ2
			Ed.	KMAFFRE		Scale 1:1		Document type:	MFS	+ V1GL12UQ51
Modification	Date	Name	Original	Replacement of				Replaced by	Project nr:	22-16151
										176

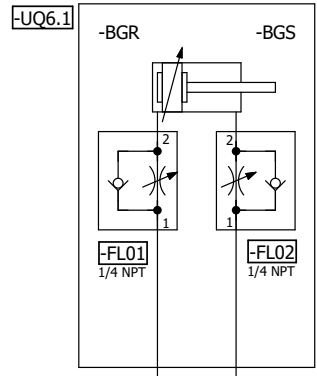

3/8" BU 3/8" BU

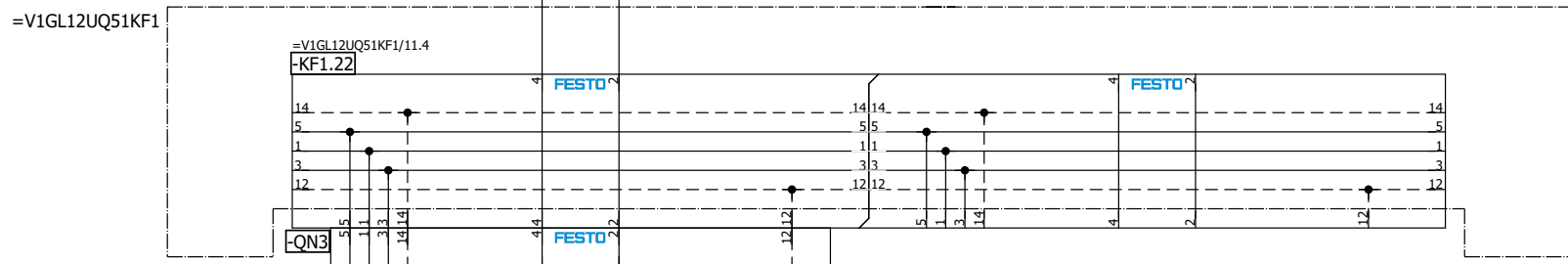

=V1GL12UQ51
-UQ6-QN3.1
Pallet Stop Sta #6
Pre-Load (RST)

=V1GL12UQ51
-UQ6-QN3.2
Pallet Stop Sta #6
Pre-Load (SET)

=V1GL12UQ51UQ2/1

=V1GL12UQ51UQx/1

Date	10/31/2022	Volvo Trucks North America	Valiant TMS	Pallet Stop Station #6 Pre-Load	Drawing name:	= 2V03&MFS-PNEU	= V1GL12UQ51UQ6
Ed.	KMAFFRE				Document type:	MFS	+ V1GL12UQ51
Appr		P6700 Underbody Floor Skin - Cell 2V03	Scale 1:1		Project nr:	22-16151	Page 1
Modification	Date	Name	Original	Replacement of	Replaced by		176

=V1GL12UQ51KF1

=V1GL12UQ51KF1/11.4
-KF1.22

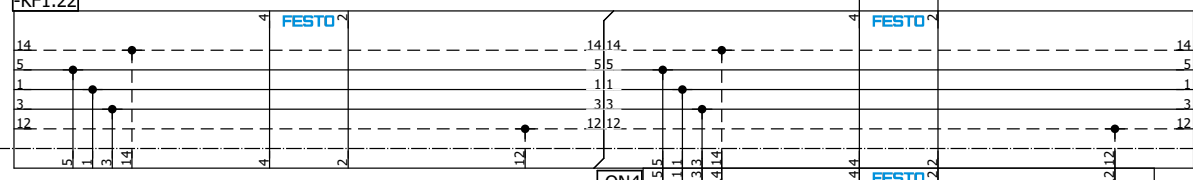

-QN4

FES.539156
VSVA-B-B52-ZD-A1-1T1L

=V1GL12UQ51
-QN4.1
Spare (RST)

=V1GL12UQ51
-QN4.2
Spare (SET)

=V1GM1+KH1/1

=V1GL12UQ51UQ6/1

Date	10/31/2022	Volvo Trucks North America	Valiant TMS	Spare	Drawing name:	= 2V03&MFS-PNEU	= V1GL12UQ51UQx	
Ed.	KMAFFRE	P6700 Underbody Floor Skin - Cell 2V03	Scale 1:1		Document type:	MFS	+ V1GL12UQ51	
Appr					Project nr:	22-16151	Page	1
Modification	Date	Name	Original	Replacement of	Replaced by		Page	176

A2

=KH0+KH0/1.7 / +V1GM1KH1-P1

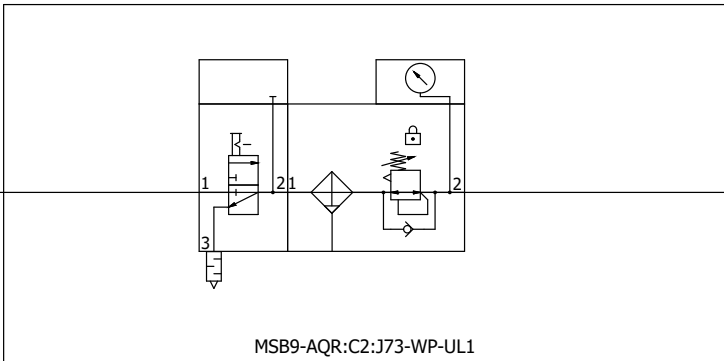

MSB9-AQR:C2:J73-WP-UL1

1/2"

+V1GM1KH1-P1 /
Lift Assist

=V1GL12UQ51UQx+V1GL12UQ51/1

=V1GM2/1

			Date	10/31/2022	Volvo Trucks North America	Valiant TMS	Incoming air supply (Lift Assist)	Drawing name:	= V1GM1		
			Ed.	KMAFFRE				= 2V03&MFS-PNEU	+ KH1		
			Appr		P6700 Underbody Floor Skin - Cell 2V03	Scale 1:1		Document type:	Project nr:	Page	1
Modification	Date	Name	Original		Replacement of		Replaced by	MFS	22-16151		176

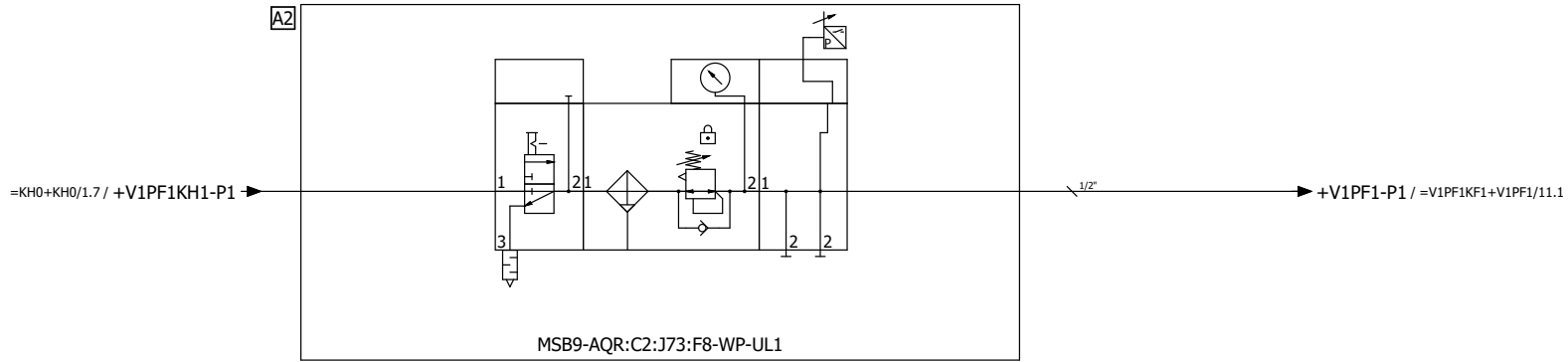

=V1GM2/1

=V1PF1KF1+V1PF1/5

			Date	10/31/2022	Volvo Trucks North America	Valiant TMS	Incoming air supply (Fixture)	Drawing name:	= V1PF1
			Ed.	KMAFFRE				= 2V04&MFS-PNEU	+ KH1
			Appr		P6700 Underbody Floor Skin - Cell 2V03	Scale 1:1		Document type:	Project nr:
Modification	Date	Name	Original		Replacement of		Replaced by	MFS	22-16151
									176

M1

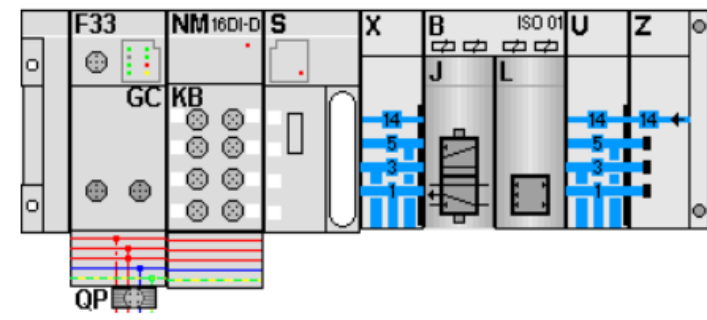

KF1.0

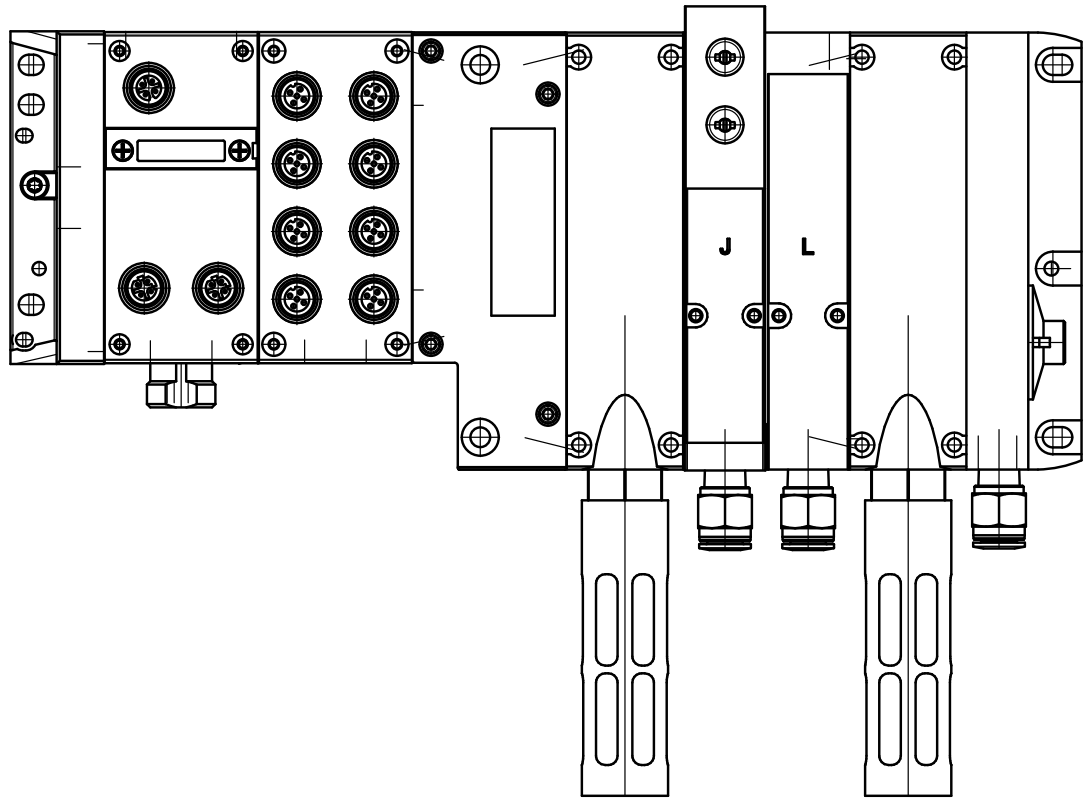

=V1PF1+KH1/1

11

		Date	10/31/2022	Volvo Trucks North America		Valiant TMS	AIR SUPPLY CONFIGURATION	Drawing name:		= V1PF1KF1	
		Ed.	KMAFFRE					= 2V06&MFS-PNEU		+ V1PF1	
		Appr		P6700 Underbody Floor Skin - Cell 2V03		Scale 1:1	Document type:		Project nr:		Page
Modification	Date	Name	Original	Replacement of	Replaced by		MFS		22-16151		5
											176

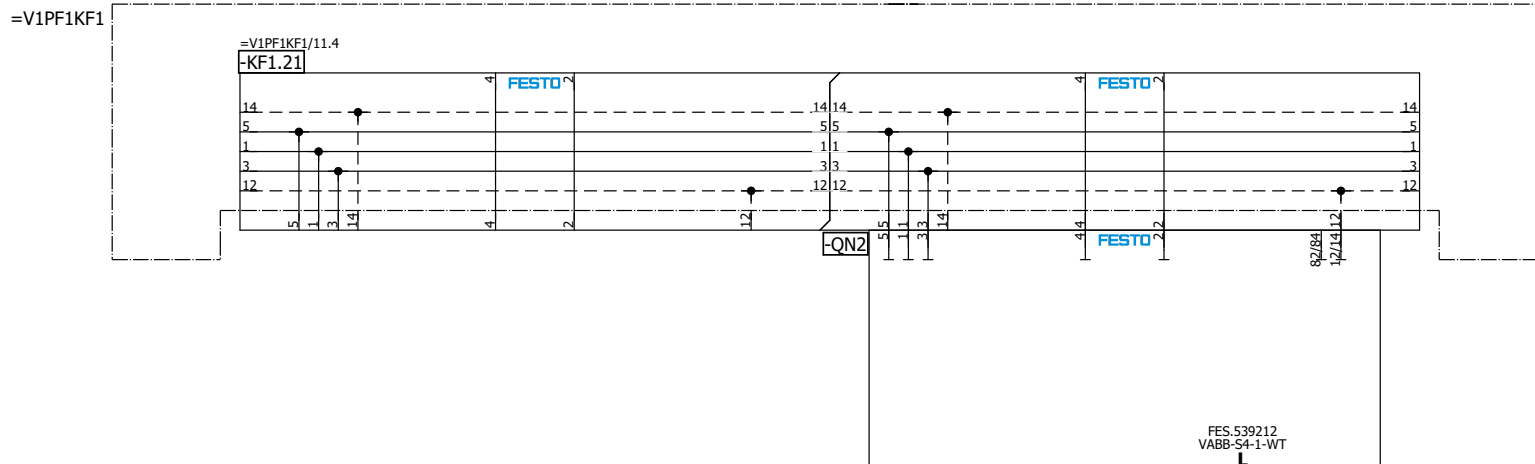

=V1PF1UQ1/1												=V1UQ51+KH1/1			
		Date	10/31/2022	Volvo Trucks North America		Valiant TMS		Spare		Drawing name: = 2V06&MFS-PNEU		= V1PF1UQ2			
		Ed.	KMAFFRE			Scale 1:1				Document type: MFS		Project nr: 22-16151			
		Appr		P6700 Underbody Floor Skin - Cell 2V03								Page 1			
Modification	Date	Name	Original	Replacement of	Replaced by							176			

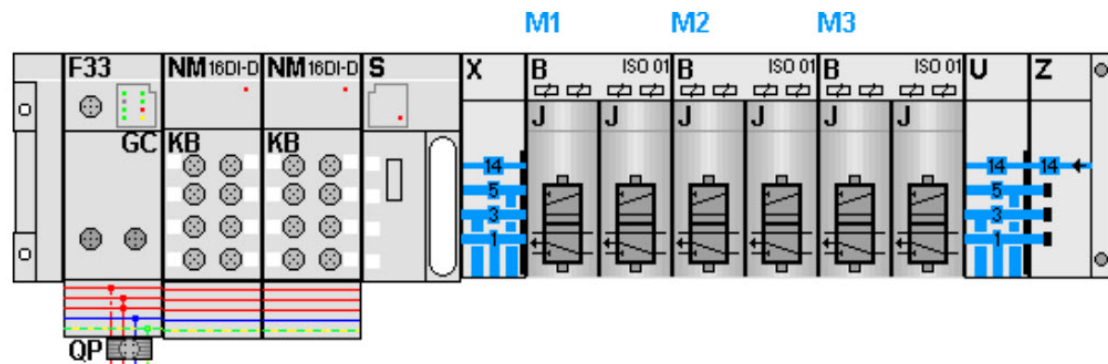

KF1.0

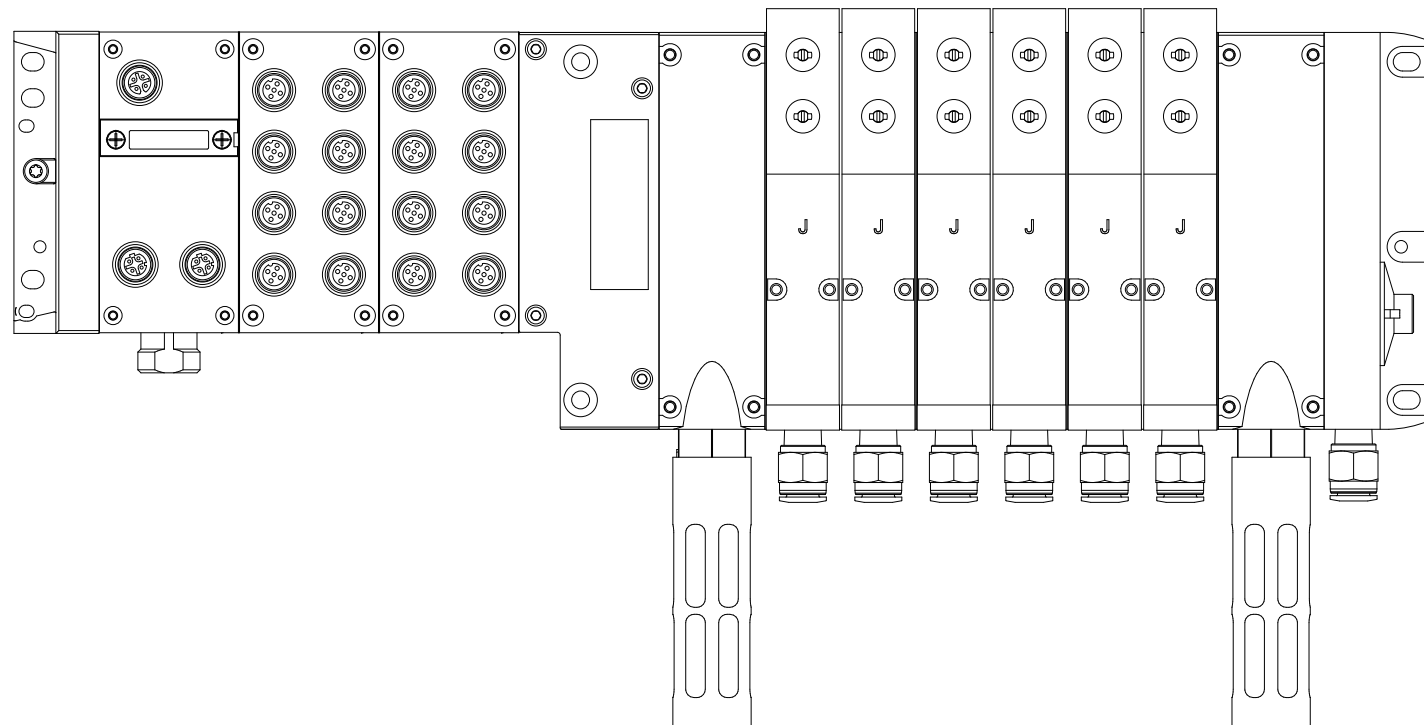

=V1UQ51+KH1/1

		Date	10/17/2022	Volvo Trucks North America		Valiant TMS	AIR SUPPLY CONFIGURATION	Drawing name:		= V1UQ51KF1
		Ed.	MKLEPADLO					= 2V03&MFS-PNEU		+ V1UQ51
		Appr		P6700 Underbody Floor Skin - Cell 2V03		Scale 1:1	Document type:		Project nr:	Page
Modification	Date	Name	Original	Replacement of	Replaced by		MFS		22-16151	5
										176

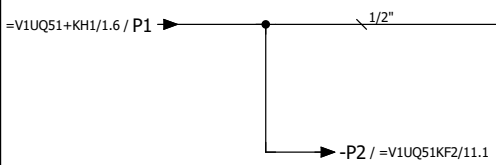
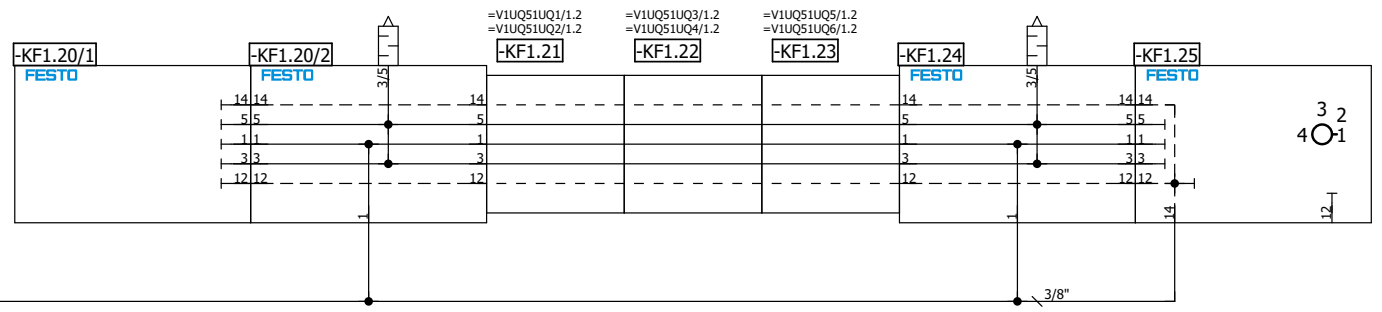
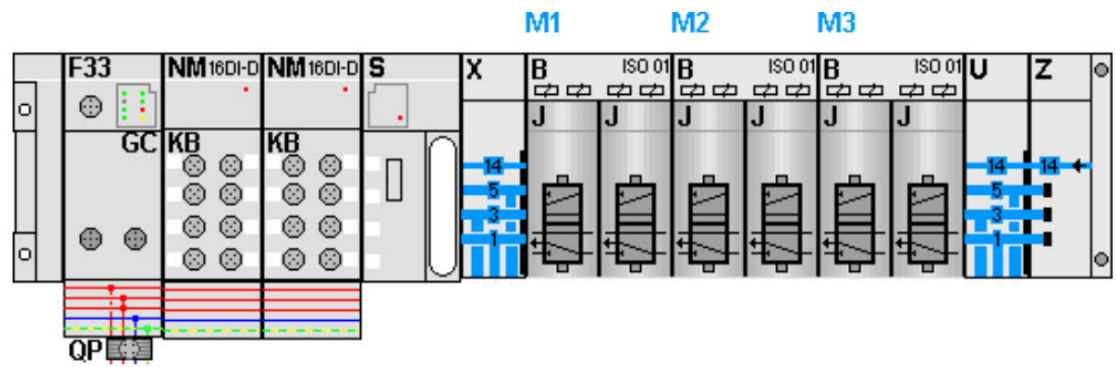

5

=V1UQ51KF2/5

		Date	9/30/2022	Volvo Trucks North America		Valiant TMS	AIR SUPPLY	Drawing name:		= V1UQ51KF1
		Ed.	MKLEPADLO					= 2V03&MFS-PNEU		+ V1UQ51
		Appr		P6700 Underbody Floor Skin - Cell 2V03		Scale 1:1	Document type:		MFS	Project nr: 22-16151
Modification	Date	Name	Original	Replacement of	Replaced by		Page		11	
										176

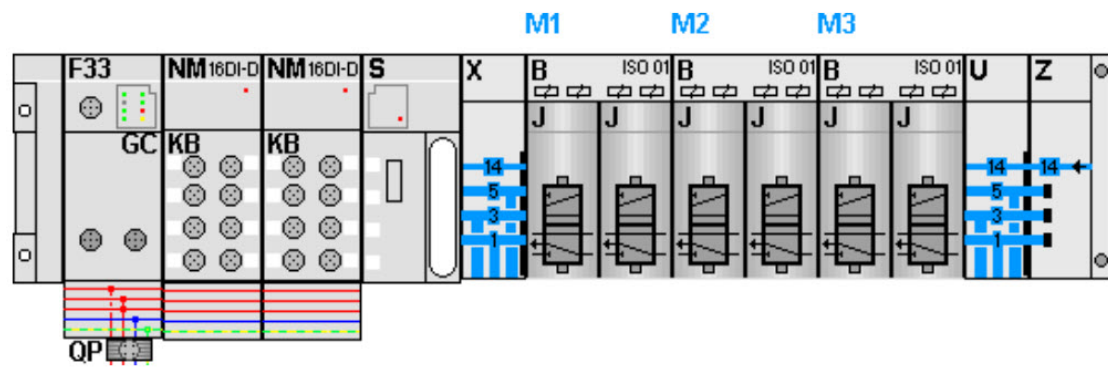

KF2.0

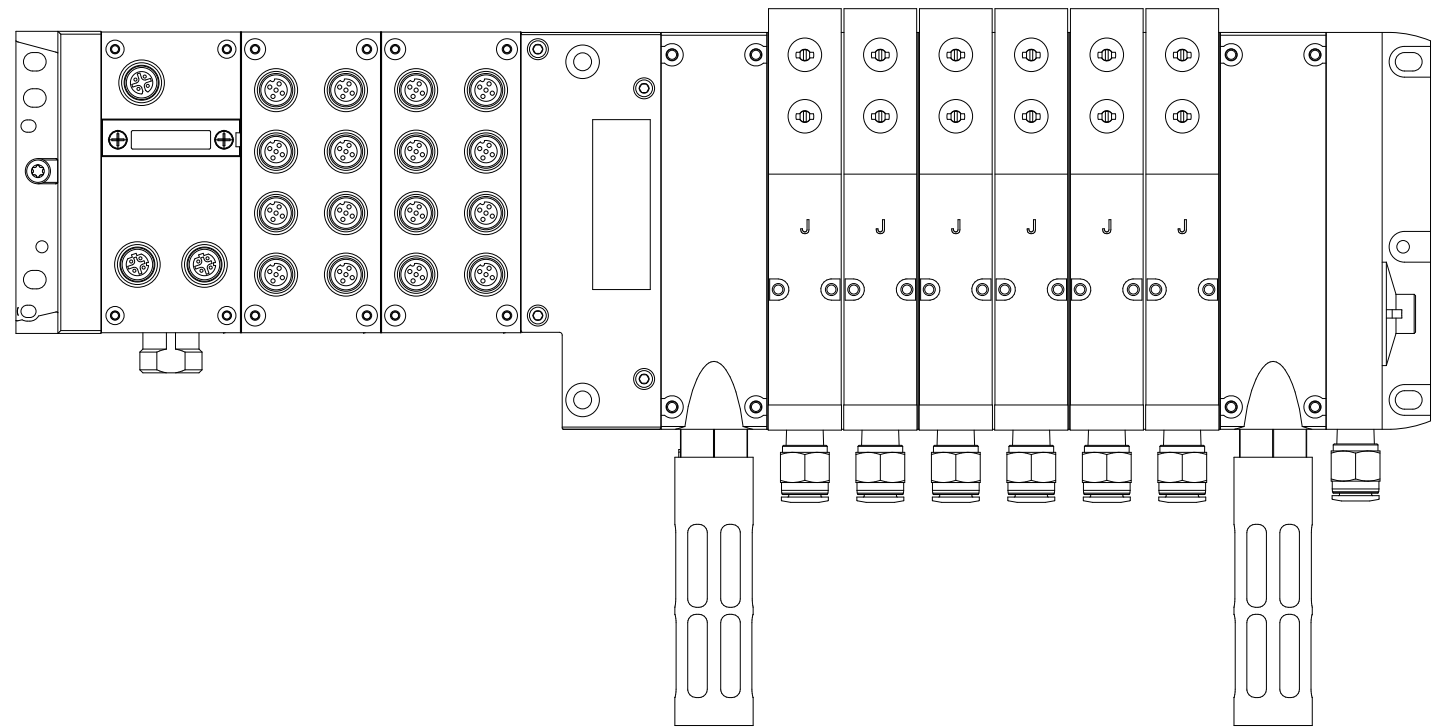

=V1UQ51KF1/11

		Date	9/30/2022	Volvo Trucks North America		 Valiant TMS	AIR SUPPLY CONFIGURATION		Drawing name: = 2V03&MFS-PNEU		= V1UQ51KF2 + V1UQ51	
		Ed.	MKLEPADLO	P6700 Underbody Floor Skin - Cell 2V03			Scale 1:1		Document type: MFS		Project nr: 22-16151	
Modification	Date	Name	Original	Replacement of	Replaced by							Page 176

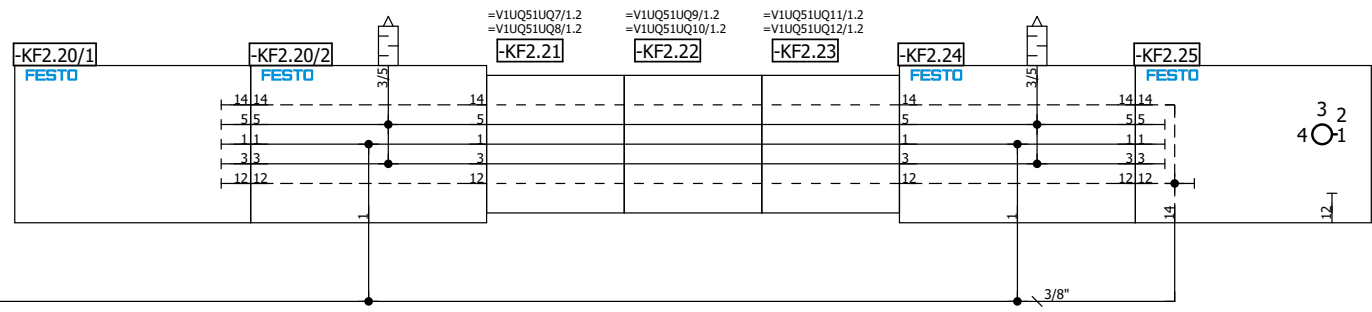
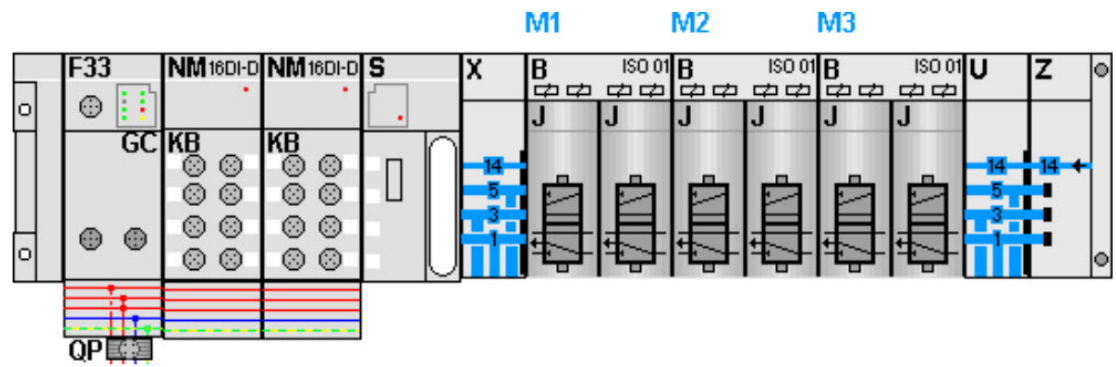

=V1UQ51KF1/11.1 / P2

=V1UQ51UQ1/1

				Date	9/30/2022	Volvo Trucks North America		Valiant TMS	AIR SUPPLY	Drawing name:		= V1UQ51KF2
				Ed.	MKLEPADLO					= 2V03&MFS-PNEU		+ V1UQ51
				Appr		P6700 Underbody Floor Skin - Cell 2V03		Scale 1:1		Document type:	Project nr:	Page
Modification	Date	Name	Original		Replacement of	Replaced by				MFS	22-16151	11
											176	

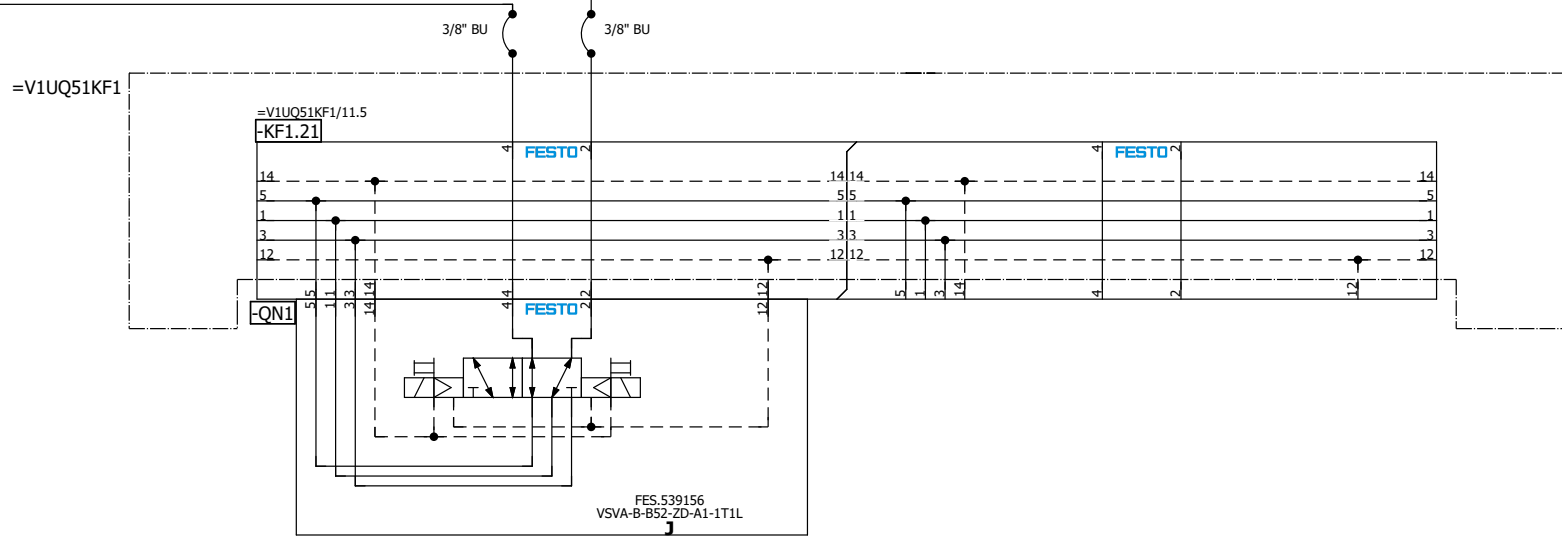
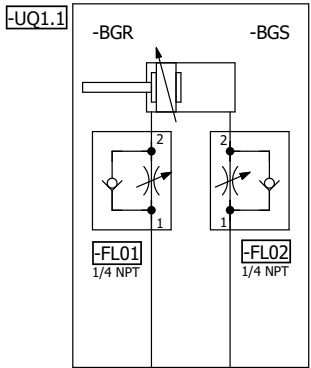

=V1UQ51
-UQ1-QN1.1
Common
Shot Pin (RST)

=V1UQ51
-UQ1-QN1.2
Common
Shot Pin (SET)

=V1UQ51UQ2/1

			Date	10/31/2022	Volvo Trucks North America	Valiant TMS	Common Shot Pin	Drawing name:	= 2V03&MFS-PNEU	= V1UQ51UQ1
			Ed.	KMAFFRE	P6700 Underbody Floor Skin - Cell 2V03	Scale 1:1		Document type:	MFS	+ V1UQ51
Modification	Date	Name	Original	Replacement of				Replaced by	Project nr:	22-16151
										176

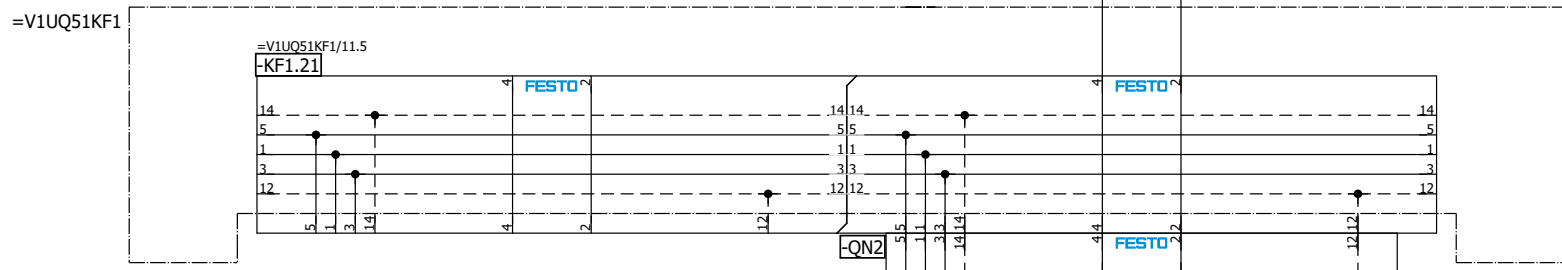
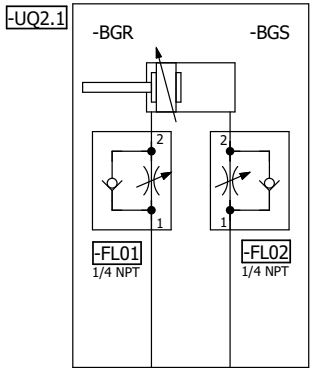

=V1UQ51
-UQ2-QN2.1
L150 Model
Shot Pin (RST)

=V1UQ51
-UQ2-QN2.2
L150 Model
Shot Pin (SET)

FES.539156
VSVA-B-B52-ZD-A1-1T1L

=V1UQ51UQ1/1			Date	10/31/2022	Volvo Trucks North America	Valiant TMS	L150 Model Shot Pin	Drawing name:	= 2V03&MFS-PNEU	= V1UQ51UQ2
			Ed.	KMAFFRE				Document type:	MFS	+ V1UQ51
			Appr		P6700 Underbody Floor Skin - Cell 2V03	Scale 1:1		Project nr:	22-16151	Page
Modification			Date	Name	Original	Replacement of	Replaced by			176

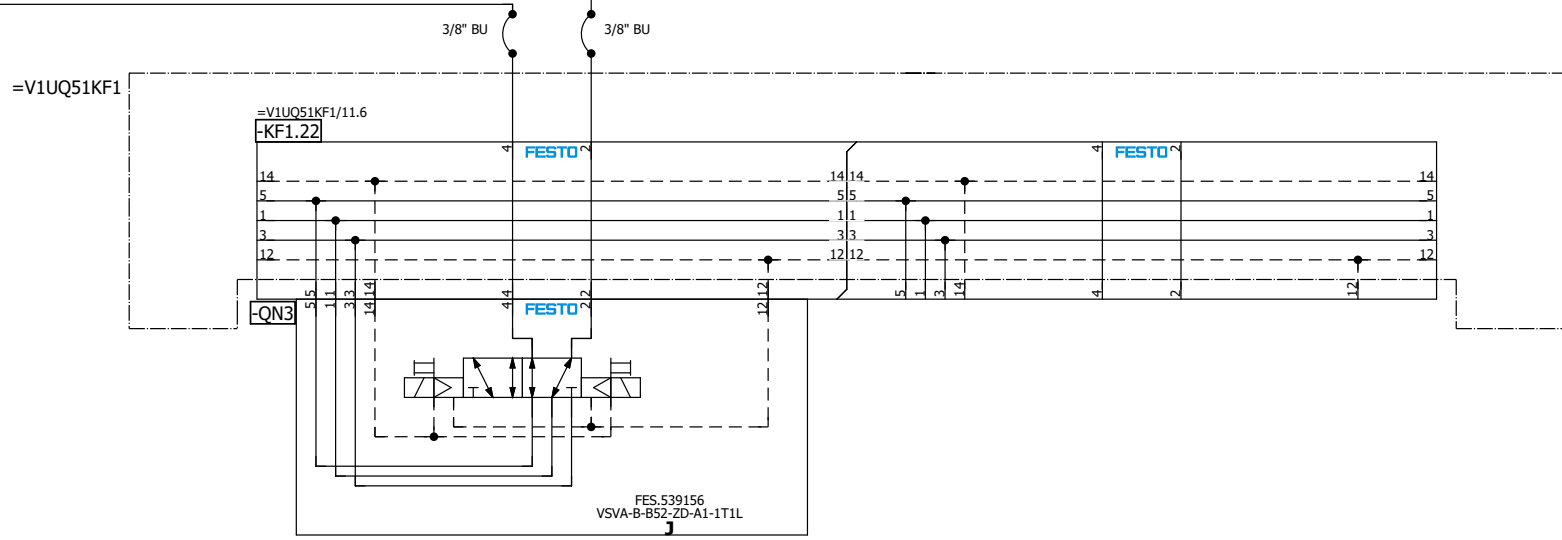
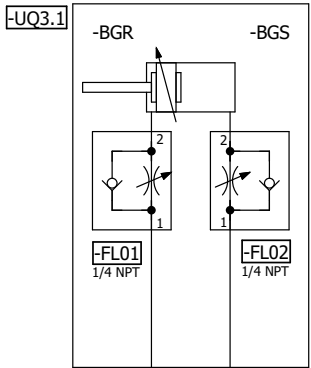

=V1UQ51
-UQ3-QN3.1
L230 Model
Shot Pin (RST)

=V1UQ51
-UQ3-QN3.2
L230 Model
Shot Pin (SET)

=V1UQ51UQ4/1

=V1UQ51UQ2/1			Date	10/31/2022	Volvo Trucks North America	Valiant TMS	L230 Model Shot Pin	Drawing name:	= 2V03&MFS-PNEU	= V1UQ51UQ3	
			Ed.	KMAFFRE				Document type:	MFS	+ V1UQ51	
			Appr		P6700 Underbody Floor Skin - Cell 2V03			Project nr:	22-16151	Page	1
Modification	Date	Name	Original		Replacement of	Replaced by	Scale 1:1				176

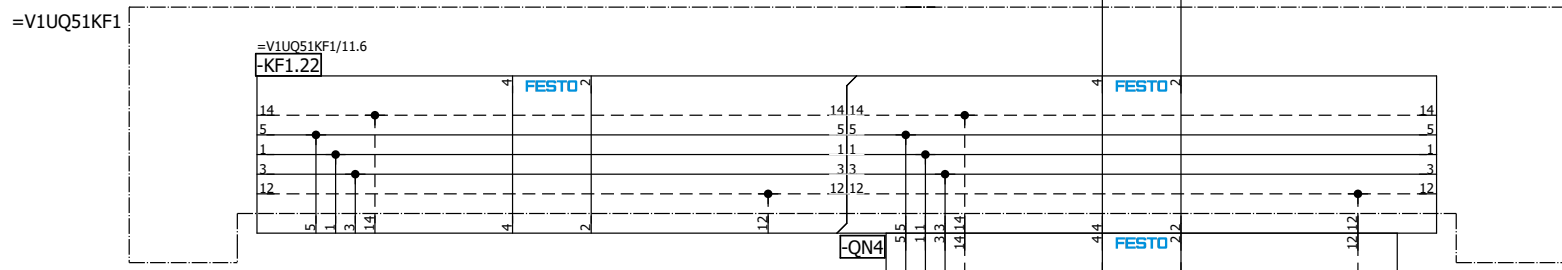
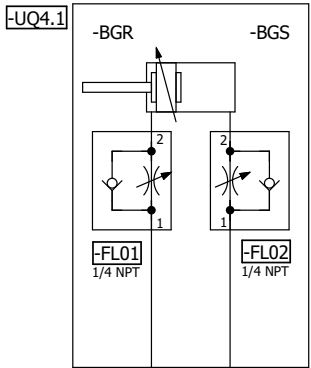

=V1UQ51
-UQ4-QN4.1
L290 Model
Shot Pin (RST)

=V1UQ51
-UQ4-QN4.2
L290 Model
Shot Pin (SET)

FES.539156
VSVA-B-B52-ZD-A1-1T1L

=V1UQ51UQ3/1			Date	10/31/2022	Volvo Trucks North America	Valiant TMS	L290 Model Shot Pin	Drawing name:	= 2V03&MFS-PNEU	= V1UQ51UQ4	
			Ed.	KMAFFRE				Document type:	MFS	+ V1UQ51	
			Appr		P6700 Underbody Floor Skin - Cell 2V03	Scale 1:1		Project nr:	22-16151	Page	1
Modification	Date	Name	Original		Replacement of	Replaced by					176

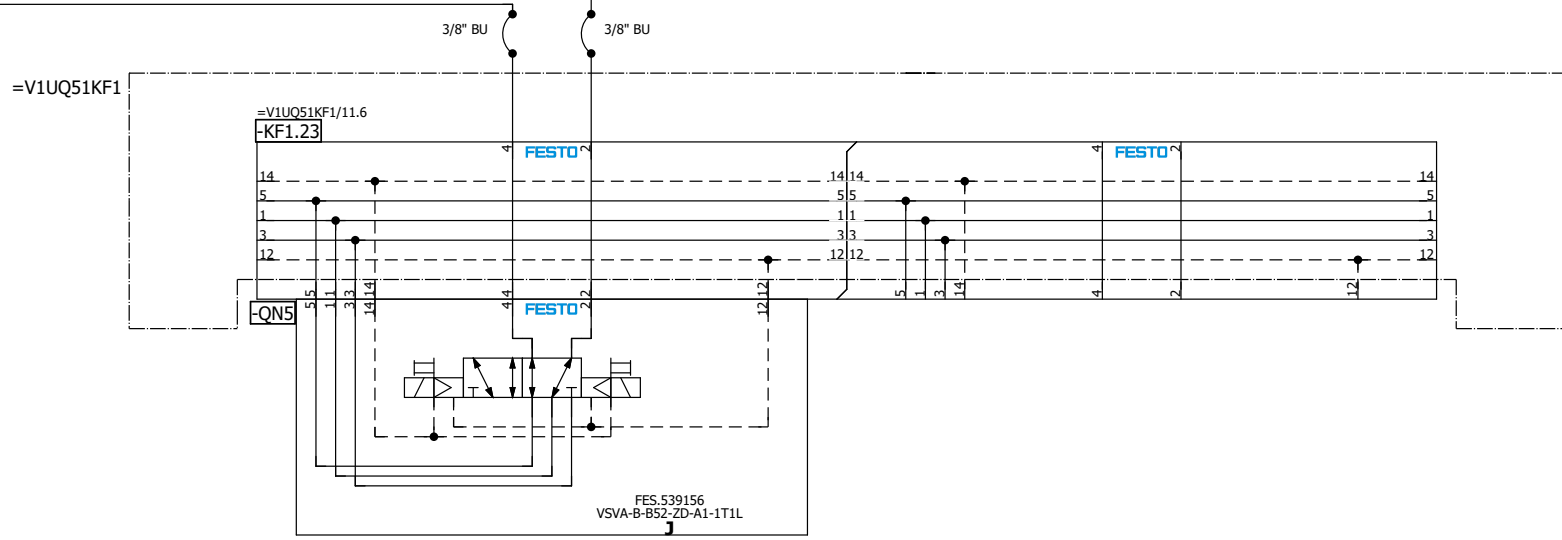
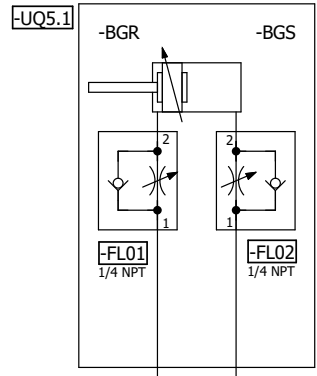

=V1UQ51
-UQ5-QN5.1
L320 Model
Shot Pin (RST)

=V1UQ51
-UQ5-QN5.2
L320 Model
Shot Pin (SET)

=V1UQ51UQ6/1

=V1UQ51UQ4/1			Date	10/31/2022	Volvo Trucks North America	Valiant TMS	L320 Model Shot Pin	Drawing name:	= 2V03&MFS-PNEU	= V1UQ51UQ5			
			Ed.	KMAFFRE					+ V1UQ51				
			Appr		P6700 Underbody Floor Skin - Cell 2V03			Document type:	MFS	Project nr:	22-16151	Page	1
Modification	Date	Name	Original		Replacement of	Replaced by	Scale	1:1				Page	176

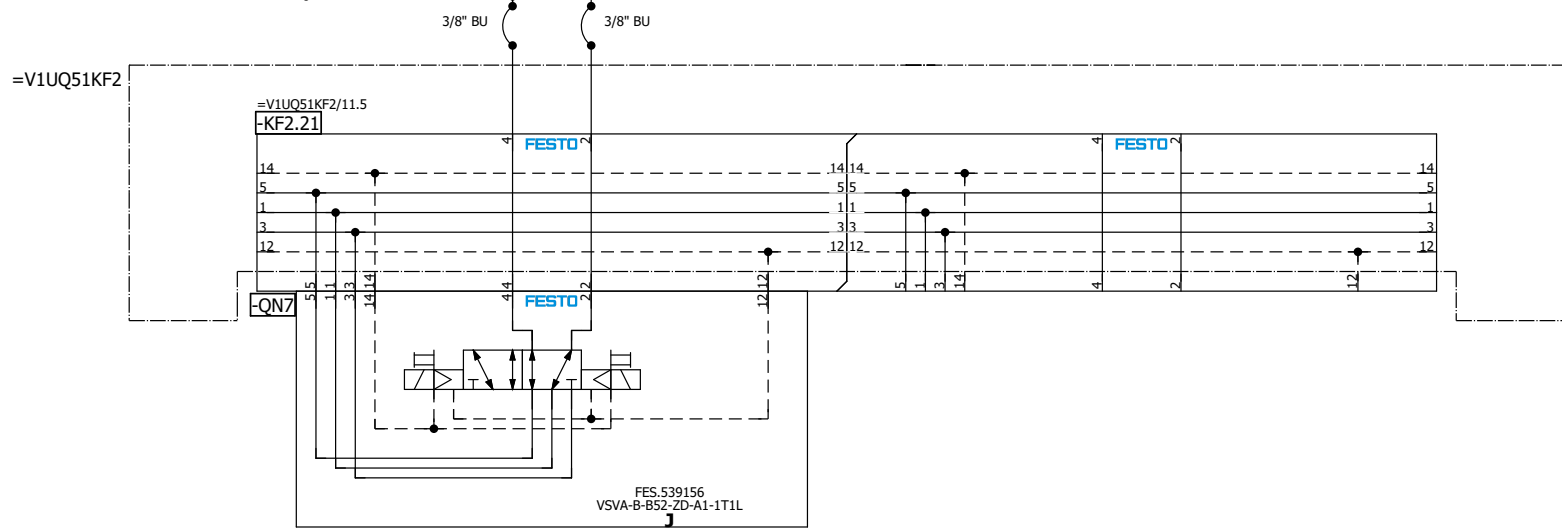
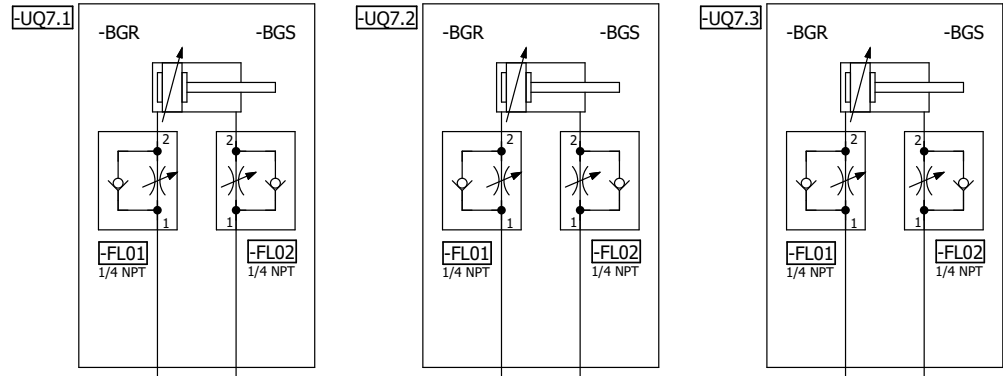

=V1UQ51
-UQ7-QN7.1
L150 Model
Clamps (RST)

=V1UQ51
-UQ7-QN7.2
L150 Model
Clamps (SET)

=V1UQ51UQ6/1 =V1UQ51UQ8/1

Date	10/31/2022	Volvo Trucks North America	Valiant TMS	L150 Model Clamps	Drawing name:	= 2V03&MFS-PNEU	= V1UQ51UQ7
Ed.	KMAFFRE	P6700 Underbody Floor Skin - Cell 2V03	Scale 1:1	Replacement of	Document type:	MFS	+ V1UQ51
Appr					Project nr:	22-16151	Page
Modification	Date	Name	Original	Replaced by			176

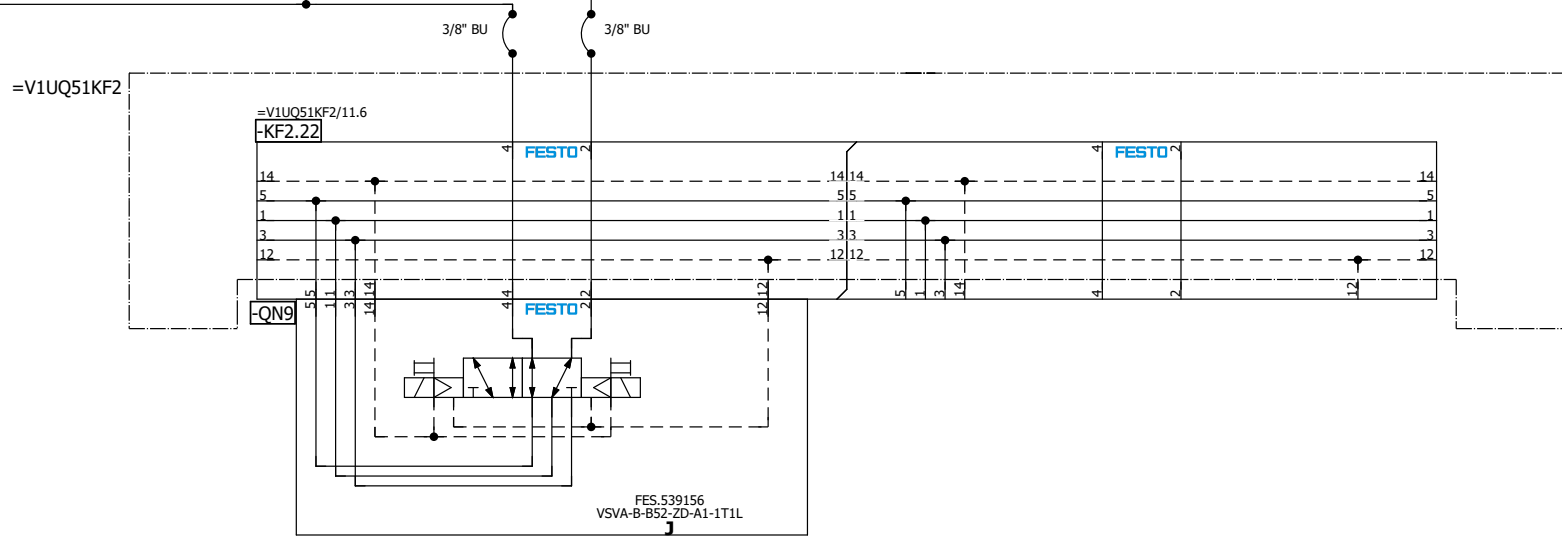
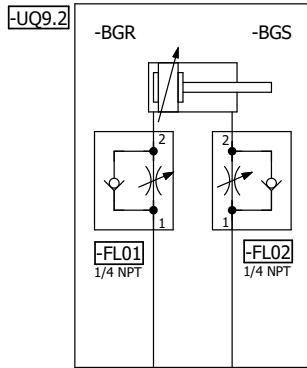
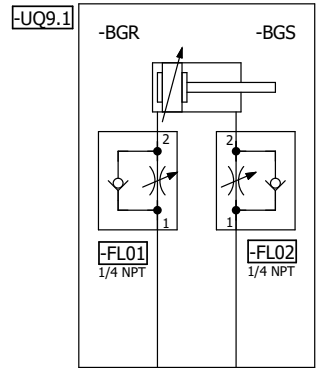

=V1UQ51
-UQ9-QN9.1
L290/320 Model
Clamps (RST)

=V1UQ51
-UQ9-QN9.2
L290/320 Model
Clamps (SET)

=V1UQ51UQ8/1 =V1UQ51UQ10/1

Date	10/31/2022	Volvo Trucks North America	Valiant TMS	L290/320 Model Clamps	Drawing name:	= 2V03&MFS-PNEU	= V1UQ51UQ9
Ed.	KMAFFRE	P6700 Underbody Floor Skin - Cell 2V03	Scale 1:1	Replacement of	Document type:	MFS	+ V1UQ51
Appr					Project nr:	22-16151	Page
Modification	Date	Name	Original	Replaced by			176

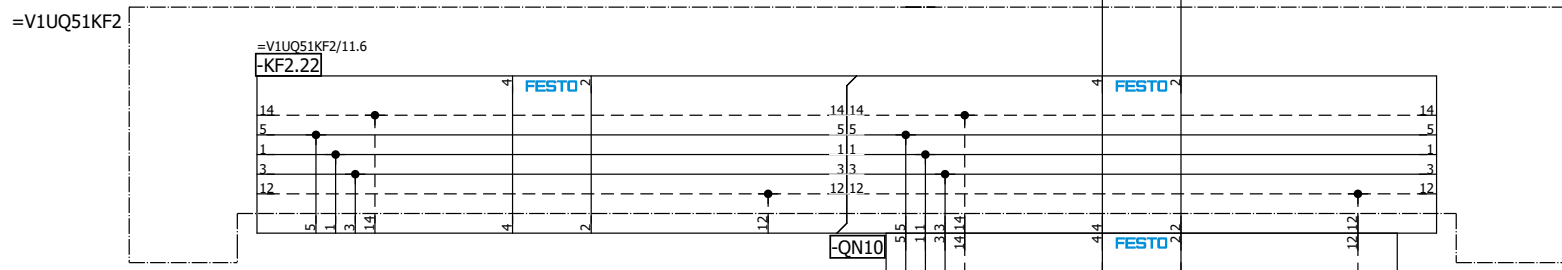
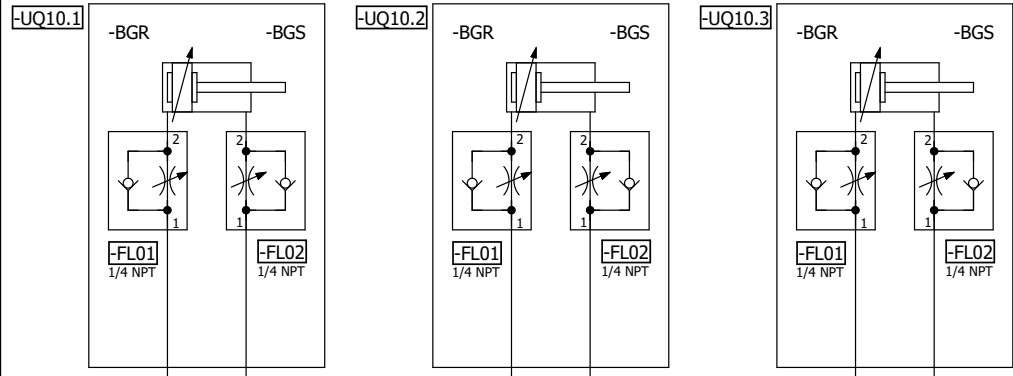

=V1UQ51
-UQ10-QN10.1
L320 Model
Clamps (RST)

=V1UQ51
-UQ10-QN10.2
L320 Model
Clamps (SET)

=V1UQ51UQ11/1

=V1UQ51UQ9/1		Date	10/31/2022	Volvo Trucks North America	Valiant TMS	L320 Model Clamps	Drawing name:	= 2V03&MFS-PNEU	= V1UQ51UQ10
		Ed.	KMAFFRE				Document type:	MFS	+ V1UQ51
		Appr		P6700 Underbody Floor Skin - Cell 2V03			Project nr:	22-16151	Page
Modification	Date	Name	Original	Replacement of	Replaced by	Scale 1:1			176

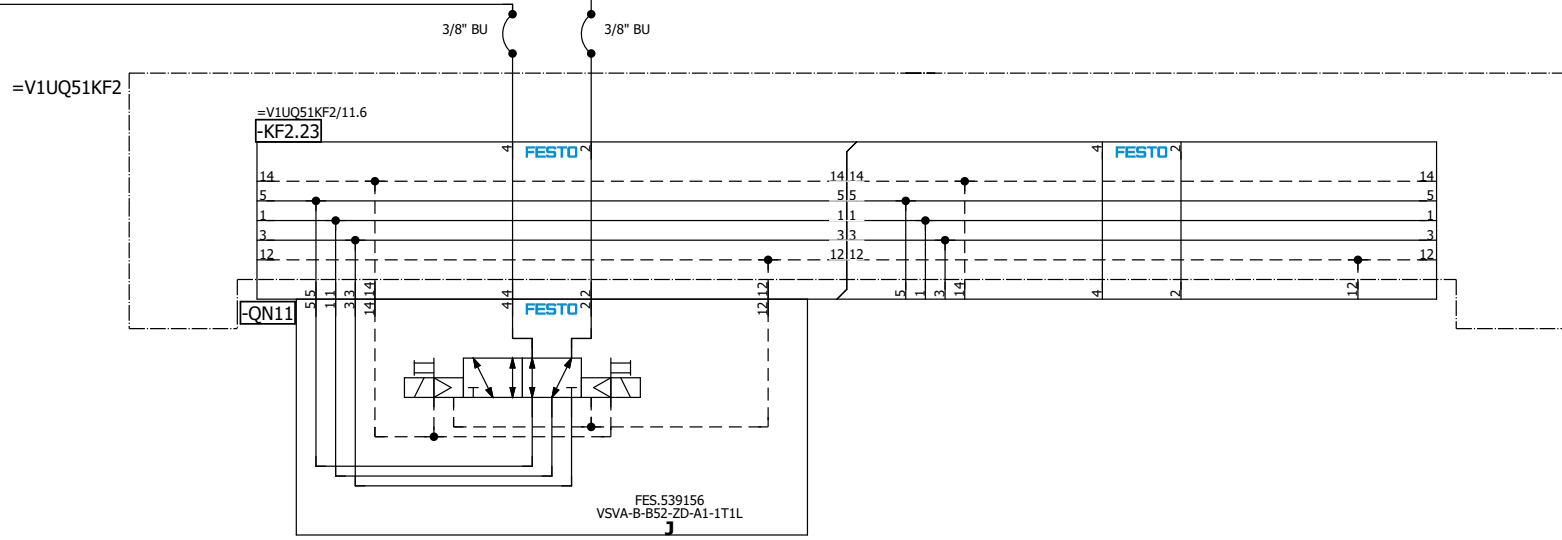
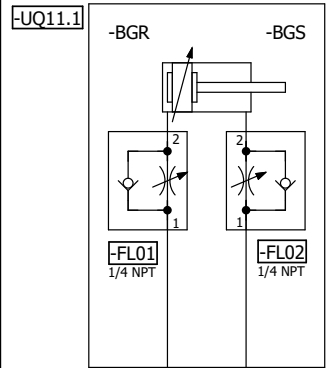

=V1UQ51
-UQ11-QN11.1
L230 Model
Clamp (RST)

=V1UQ51
-UQ11-QN11.2
L230 Model
Clamp (SET)

=V1UQ51UQ10/1 =V1UQ51UQ12/1

Date	10/31/2022	Volvo Trucks North America	Valiant TMS	L230 Model Clamp	Drawing name:	= 2V03&MFS-PNEU	= V1UQ51UQ11
Ed.	KMAFFRE				Document type:	MFS	+ V1UQ51
Appr		P6700 Underbody Floor Skin - Cell 2V03	Scale 1:1		Project nr:	22-16151	Page 1
Modification	Date	Name	Original	Replacement of	Replaced by		176

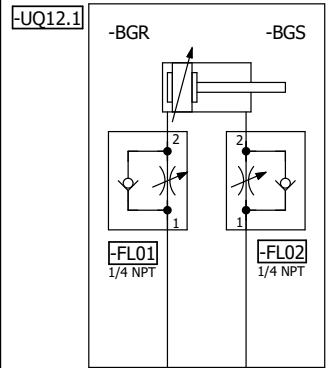

=V1UQ51KF2

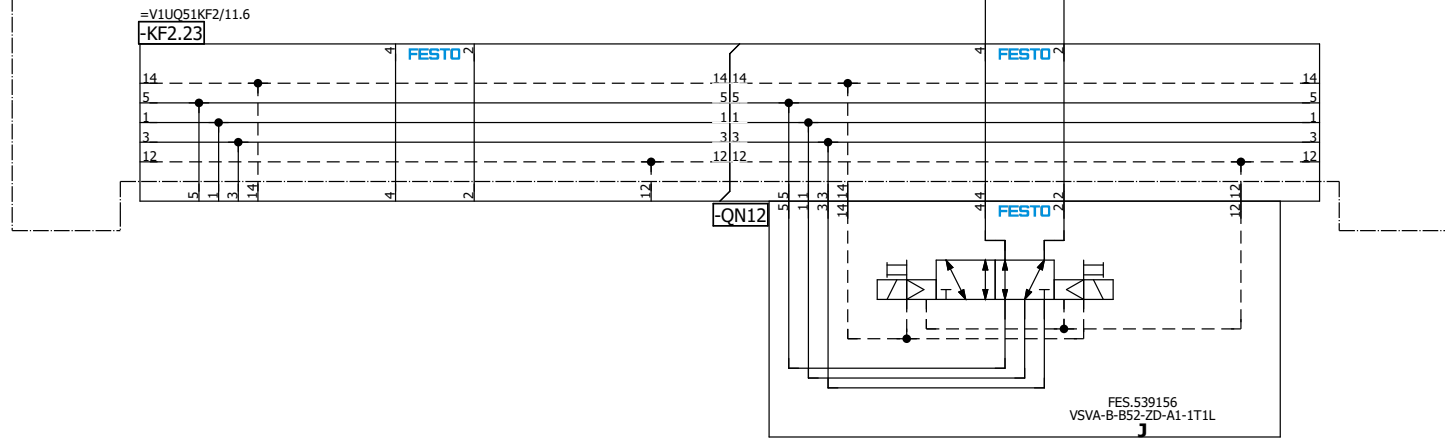

=V1UQ51
-UQ12-QN12.1
L290 Model
Clamp (RST)

=V1UQ51
-UQ12-QN12.2
L290 Model
Clamp (SET)

=V1WR1+KH1/1

			Date	10/31/2022	Volvo Trucks North America	Valiant TMS	L290 Model Clamp	Drawing name: = 2V03&MFS-PNEU		= V1UQ51UQ12 + V1UQ51
			Ed.	KMAFFRE	P6700 Underbody Floor Skin - Cell 2V03	Scale 1:1		Document type:		Project nr:
			Appr					MFS	22-16151	Page
Modification	Date	Name	Original		Replacement of	Replaced by				176

A2

=KH0+KH0/1.7 / +V1WR1KH1-P1

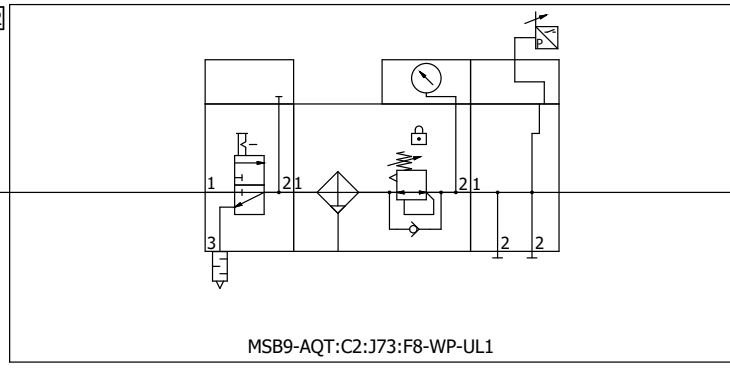

MSB9-AQT:C2:J73:F8-WP-UL1

1"

Turn table slip ring

1/2"

+V1WR1UQ51-P1 / =V1WR1UQ51KF1+V1WR1UQ51/11.0

1/2"

+V1WR1UQ52-P1 / =V1WR1UQ52KF1+V1WR1UQ52/11.0

=V1UQ51UQ12+V1UQ51/1

=V1WR1UQ51KF1+V1WR1UQ51/5

			Date	10/31/2022	Volvo Trucks North America	Valiant TMS	Incoming air supply (Turn Table)	Drawing name:		= V1WR1		
			Ed.	KMAFFRE				= 2V03&MFS-PNEU		+ KH1		
			Appr		P6700 Underbody Floor Skin - Cell 2V03	Scale 1:1	Document type:		MFS	Project nr: 22-16151	Page	1
Modification	Date	Name	Original		Replacement of		Replaced by					

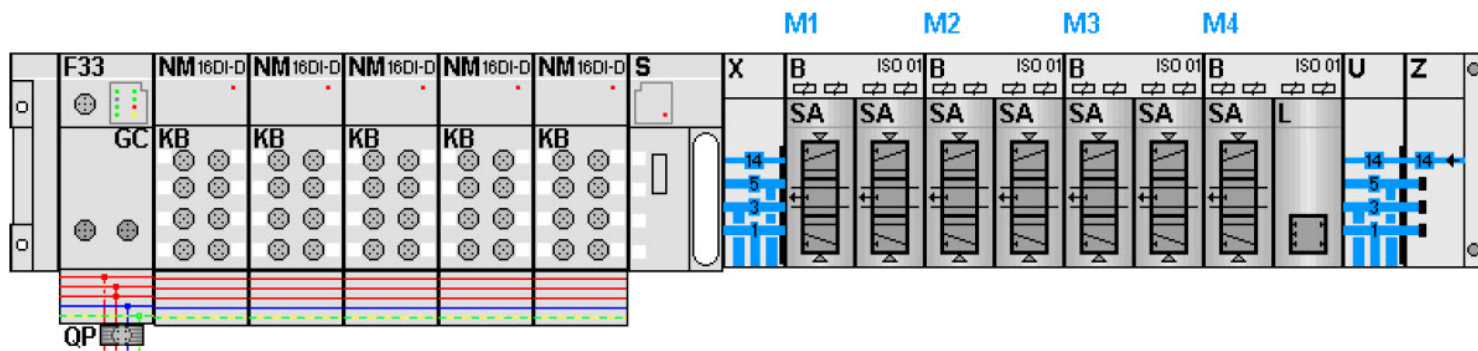

ØF1.0

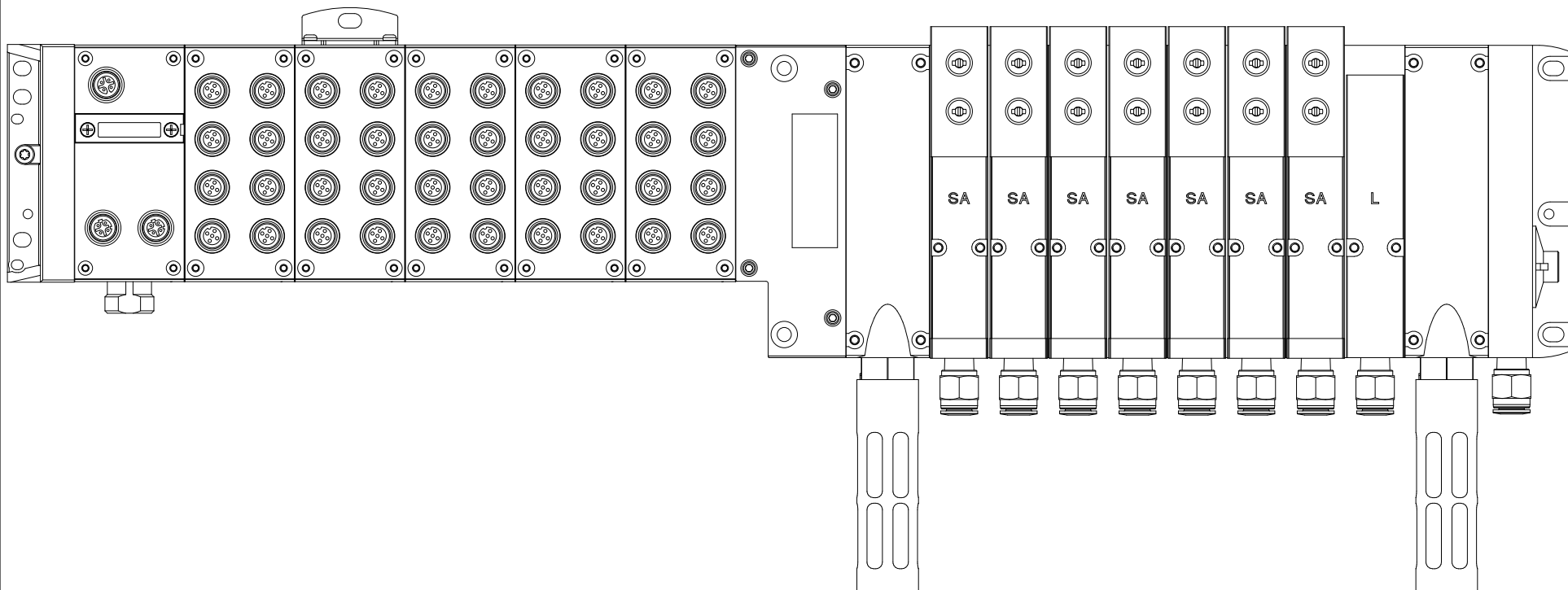

=V1WR1+KH1/1

		Date	9/30/2022	Volvo Trucks North America	Valiant TMS	AIR SUPPLY CONFIGURATION	Drawing name:		= V1WR1UQ51KF1
		Ed.	MKLEPADLO				= 2V03&MFS-PNEU		+ V1WR1UQ51
		Appr		P6700 Underbody Floor Skin - Cell 2V03	Scale 1:1		Document type:	Project nr:	Page
Modification	Date	Name	Original	Replacement of			Replaced by	MFS	22-16151

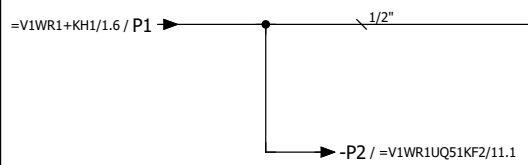
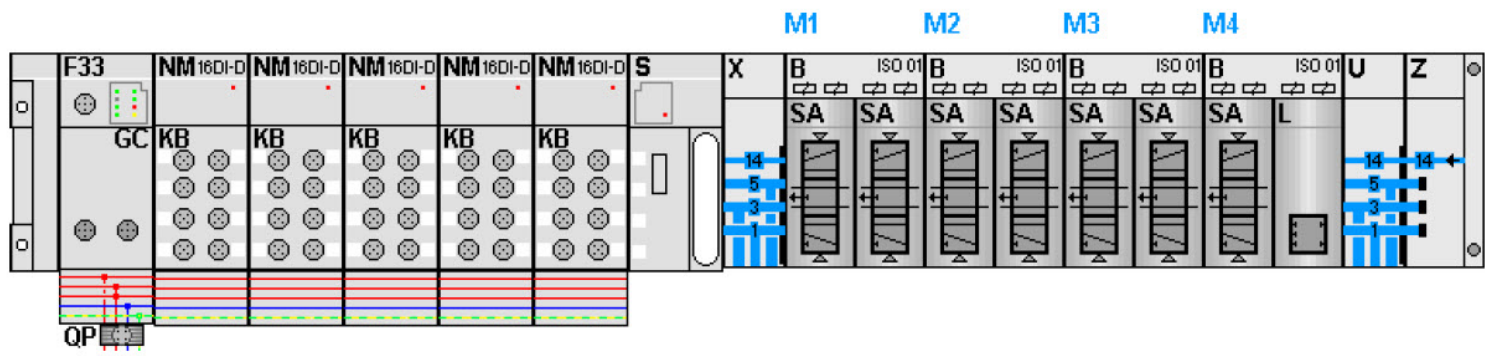

5

=V1WR1UQ51KF2/5

Date		9/30/2022		Volvo Trucks North America		Valiant TMS		AIR SUPPLY		Drawing name:		= 2V03&MFS-PNEU		= V1WR1UQ51KF1	
Ed.		MKLEPADLO		P6700 Underbody Floor Skin - Cell 2V03		Scale 1:1				Document type:		MFS		+ V1WR1UQ51	
Appr				Replacement of		Replaced by				Project nr:		22-16151		Page 11	
Modification		Date		Name		Original								176	

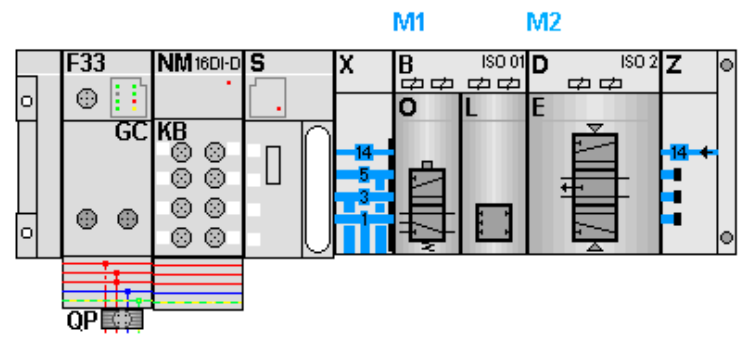

KF2.0

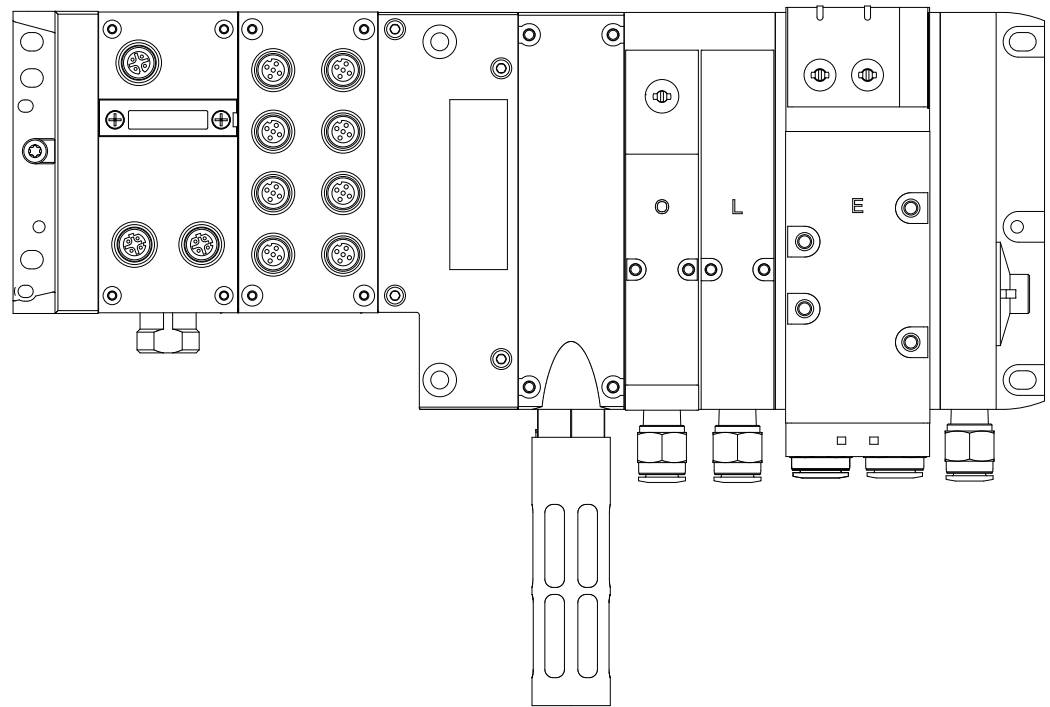

=V1WR1UQ51KF1/11			Date	9/30/2022	Volvo Trucks North America	Valiant TMS	AIR SUPPLY CONFIGURATION	Drawing name:	= 2V03&MFS-PNEU	= V1WR1UQ51KF2			
			Ed.	MKLEPADLO						+ V1WR1UQ51			
			Appr		P6700 Underbody Floor Skin - Cell 2V03			Document type:	MFS	Project nr:	22-16151	Page	5
Modification	Date	Name	Original		Replacement of	Replaced by	Scale 1:1					Page	176

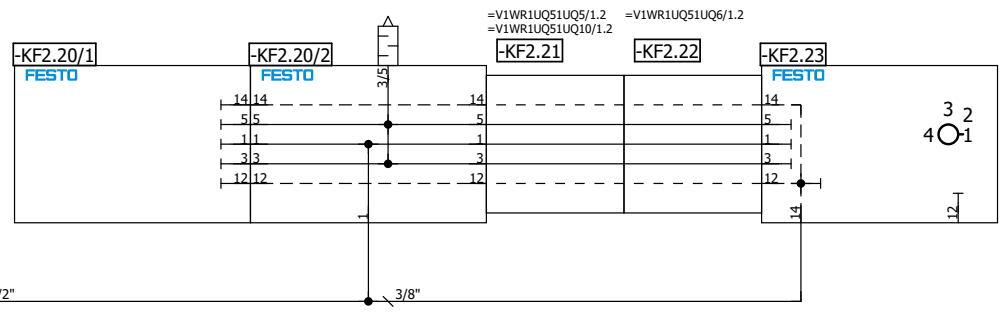
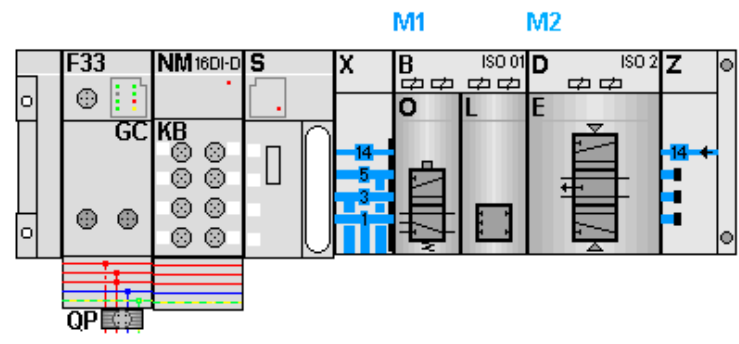

=V1WR1UQ51KF1/11.1 / P2

=V1WR1UQ51UQ1/1

5

		Date	9/30/2022	Volvo Trucks North America		Valiant TMS	AIR SUPPLY	Drawing name:		= V1WR1UQ51KF2			
		Ed.	MKLEPADLO					= 2V03&MFS-PNEU		+ V1WR1UQ51			
		Appr		P6700 Underbody Floor Skin - Cell 2V03		Scale 1:1	Document type:		MFS	Project nr:	22-16151	Page	11
Modification	Date	Name	Original	Replacement of	Replaced by							Page	176

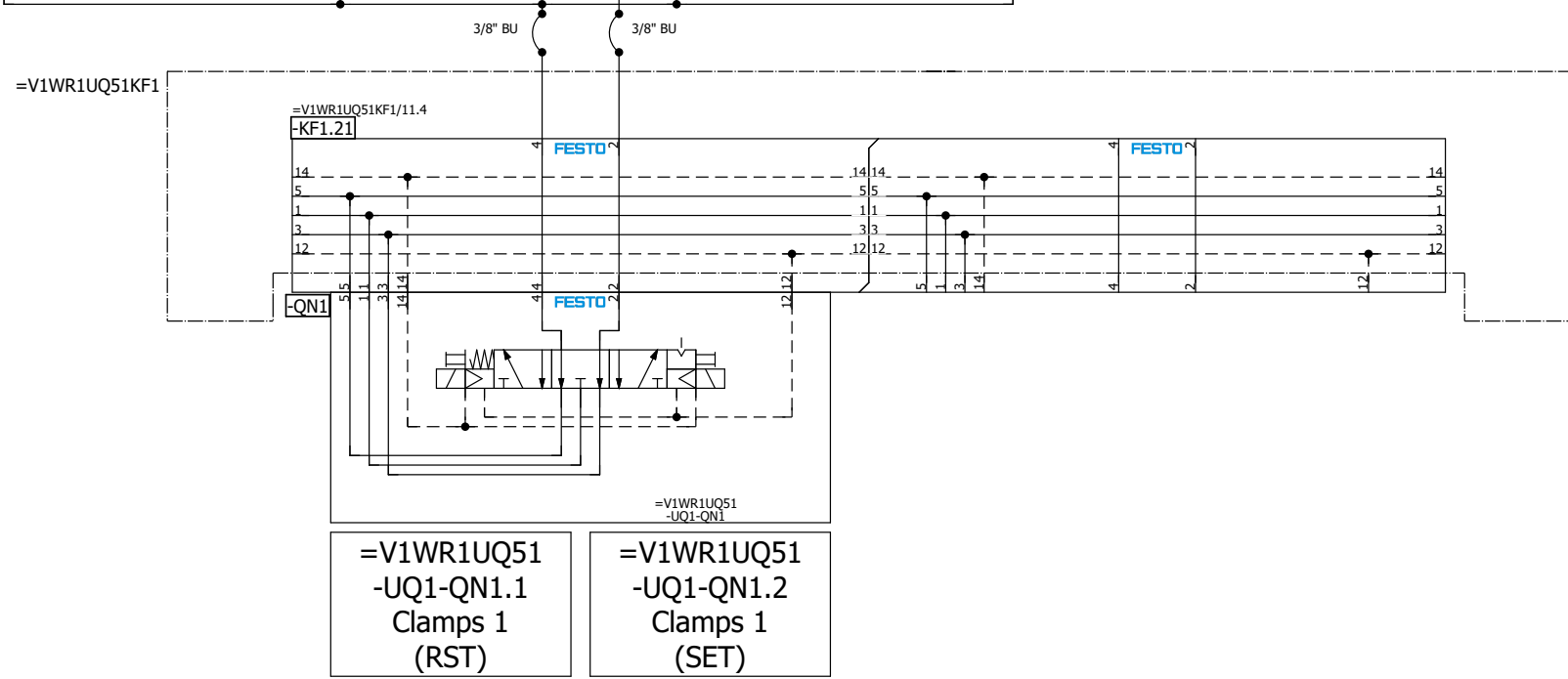
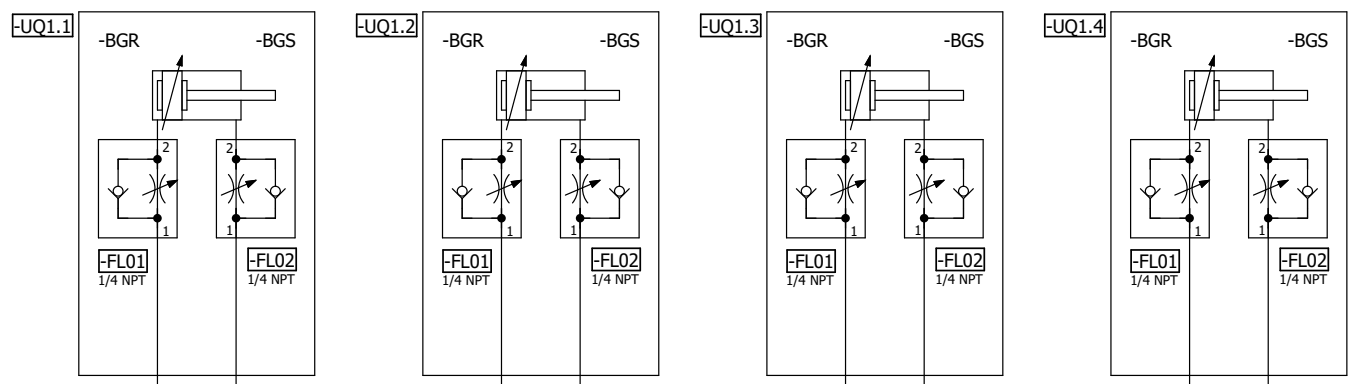

=V1WR1UQ51KF2/11

=V1WR1UQ51UQ2/1

Date	9/30/2022	Volvo Trucks North America	Valiant TMS	Clamps 1	Drawing name:	= 2V03&MFS-PNEU	= V1WR1UQ51UQ1
Ed.	MKLEPADLO	P6700 Underbody Floor Skin - Cell 2V03	Scale 1:1		Document type:	MFS	+ V1WR1UQ51
Appr					Project nr:	22-16151	Page
Modification	Date	Name	Original	Replacement of	Replaced by		176

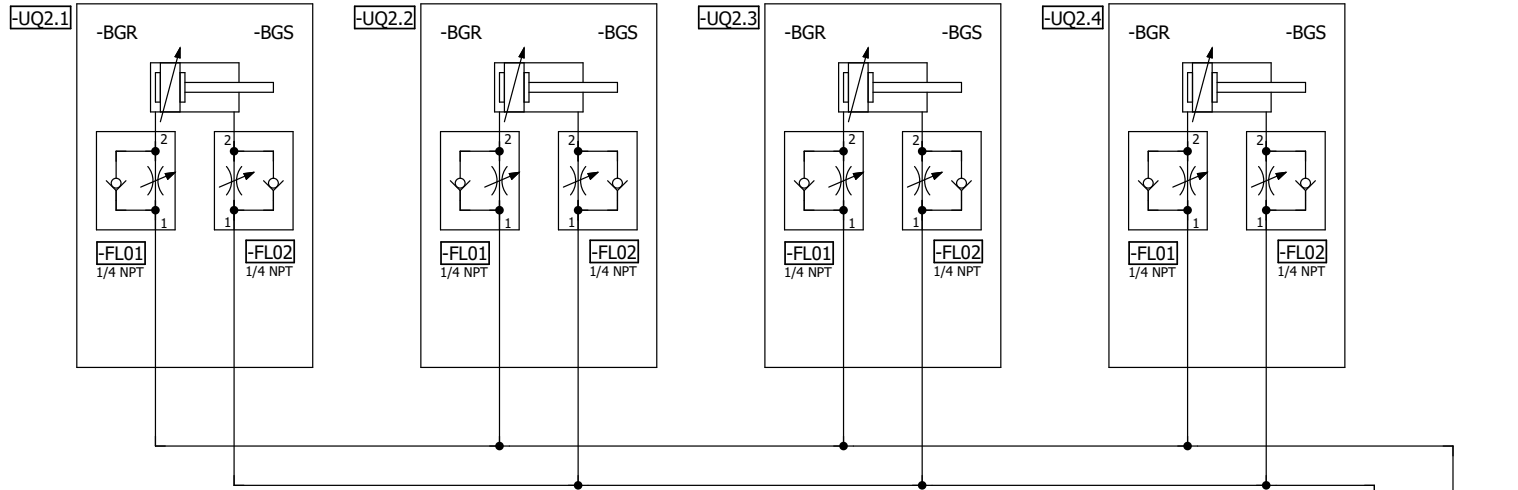

=V1WR1UQ51KF1

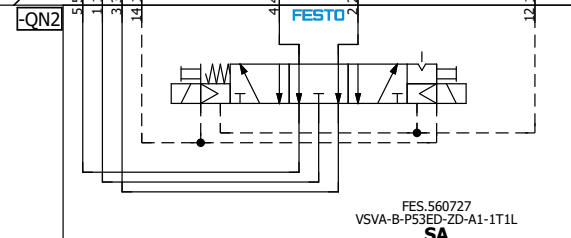
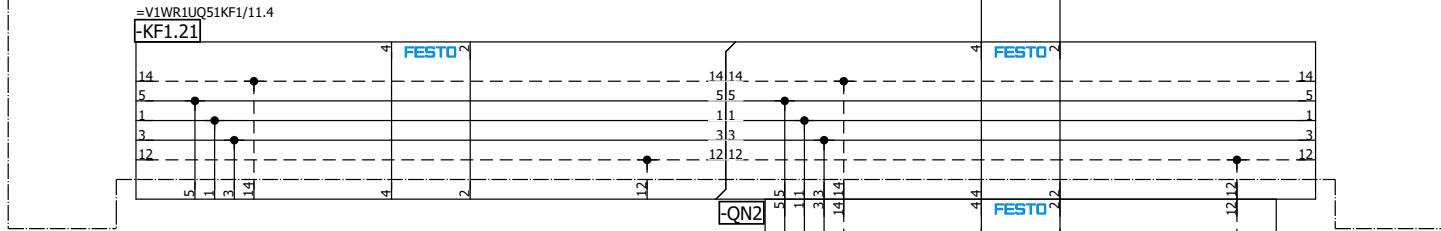

=V1WR1UQ51
-UQ2-QN2.1
Clamps 2
(RST)

=V1WR1UQ51
-UQ2-QN2.2
Clamps 2
(SET)

=V1WR1UQ51UQ3/1

			Date	9/30/2022	Volvo Trucks North America	Valiant TMS	Clamps 2	Drawing name:	= 2V03&MFS-PNEU	= V1WR1UQ51UQ2
			Ed.	MKLEPADLO		Scale 1:1		Document type:	MFS	+ V1WR1UQ51
Modification	Date	Name	Original	Replacement of				Replaced by	Project nr:	22-16151
										176

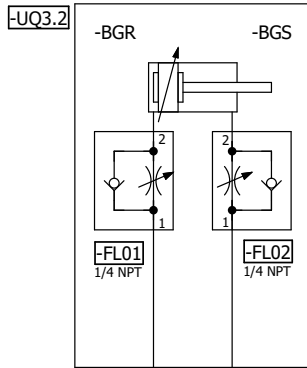
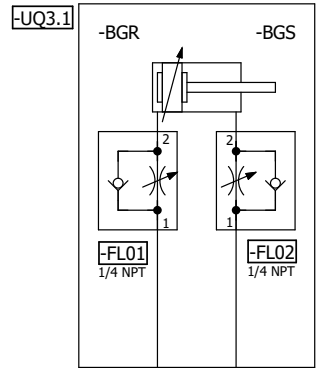

3/8" BU 3/8" BU

=V1WR1UQ51KF1

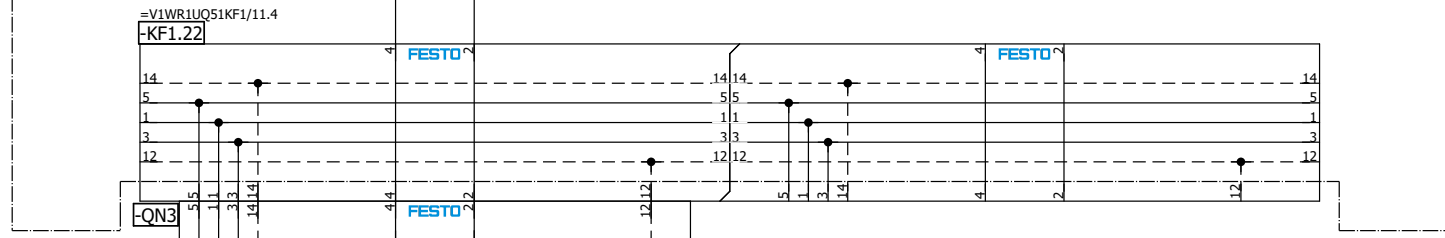

=V1WR1UQ51
-UQ3-QN3.1
Clamps 3
(RST)

=V1WR1UQ51
-UQ3-QN3.2
Clamps 3
(SET)

=V1WR1UQ51UQ2/1

=V1WR1UQ51UQ4/1

Date	9/30/2022	Volvo Trucks North America	Valiant TMS	Clamps 3	Drawing name:	= 2V03&MFS-PNEU	= V1WR1UQ51UQ3
Ed.	MKLEPADLO	P6700 Underbody Floor Skin - Cell 2V03	Scale 1:1	Document type:	MFS	Project nr:	22-16151
Appr							
Modification	Date	Name	Original				176

=V1WR1UQ51UQ6/1.1
UQ6.1

=V1WR1UQ51UQ6/1.2
UQ6.2

=V1WR1UQ51KF2

=V1WR1UQ51KF2/11.4
-KF2.21

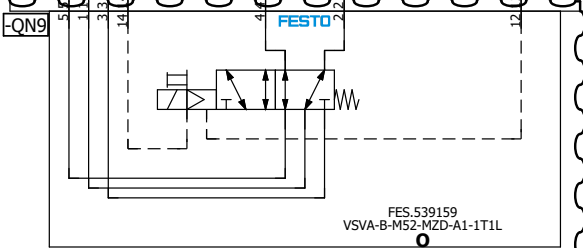
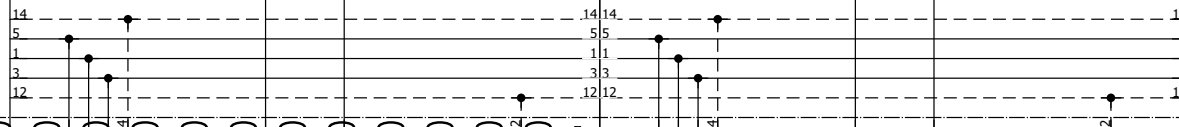

=V1WR1UQ51
-UQ5-QN9.2
Common Lift Unit
Locks (SET)

3/8" BU

=V1WR1UQ51UQ6/1

=V1WR1UQ51UQ4/1

Date		10/31/2022	Volvo Trucks North America		Valiant TMS		Swivel Unit Locks		Drawing name: = 2V03&MFS-PNEU		= V1WR1UQ51UQ5 + V1WR1UQ51	
Ed.		KMAFFRE	P6700 Underbody Floor Skin - Cell 2V03		Scale 1:1				Document type: MFS		Project nr: 22-16151	
Appr			Replacement of		Replaced by						Page 1	
Modification		Date	Name		Original						Page 176	

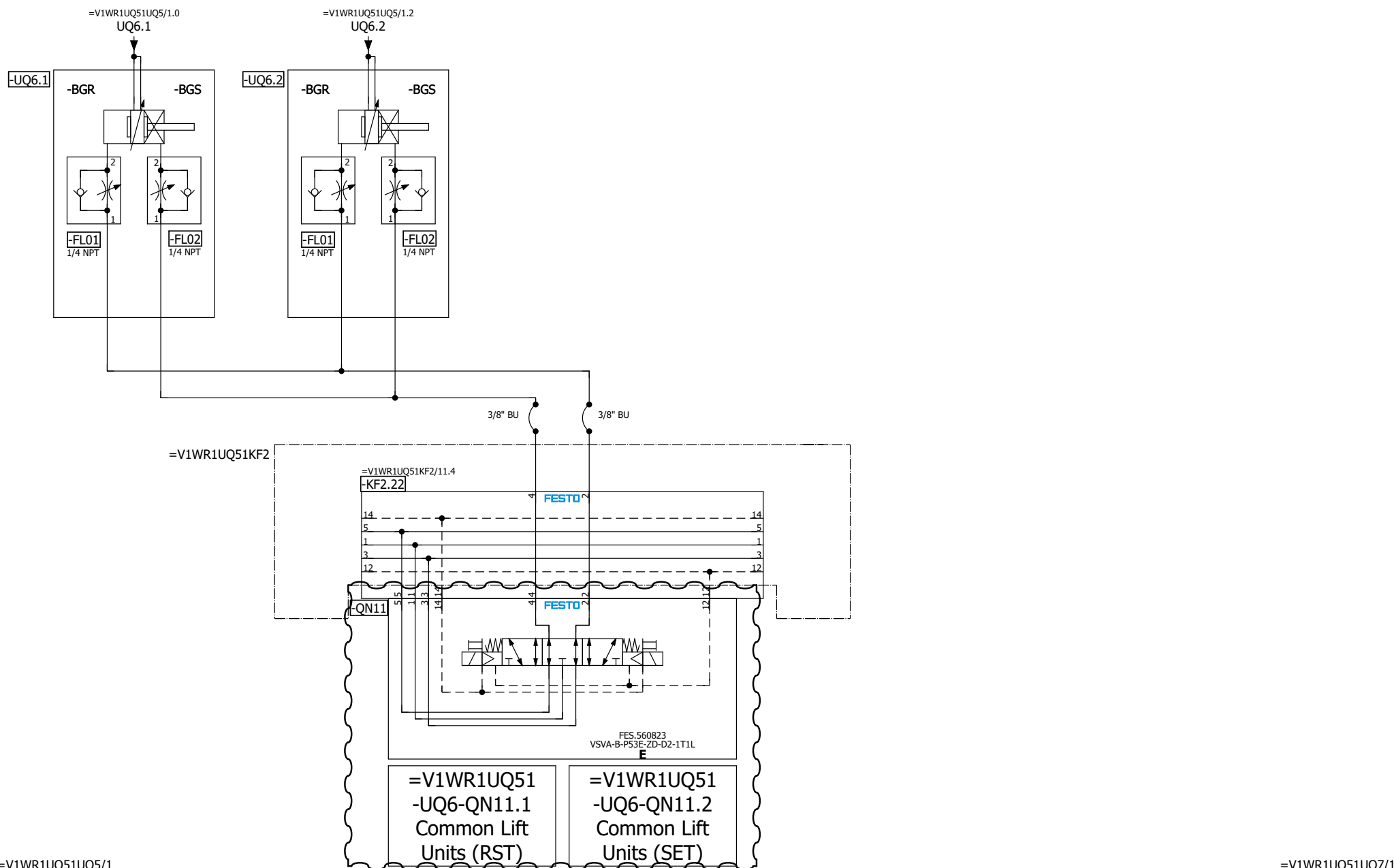

=V1WR1UQ51UQ5/1 =V1WR1UQ51UQ7/1

Date	10/31/2022	Volvo Trucks North America	Valiant TMS	Swivel Units	Drawing name:	= 2V03&MFS-PNEU	= V1WR1UQ51UQ6
Ed.	KMAFFRE				Document type:	MFS	+ V1WR1UQ51
Appr		P6700 Underbody Floor Skin - Cell 2V03	Scale 1:1		Project nr:	22-16151	Page 1
Modification	Date	Name	Original	Replacement of	Replaced by		176

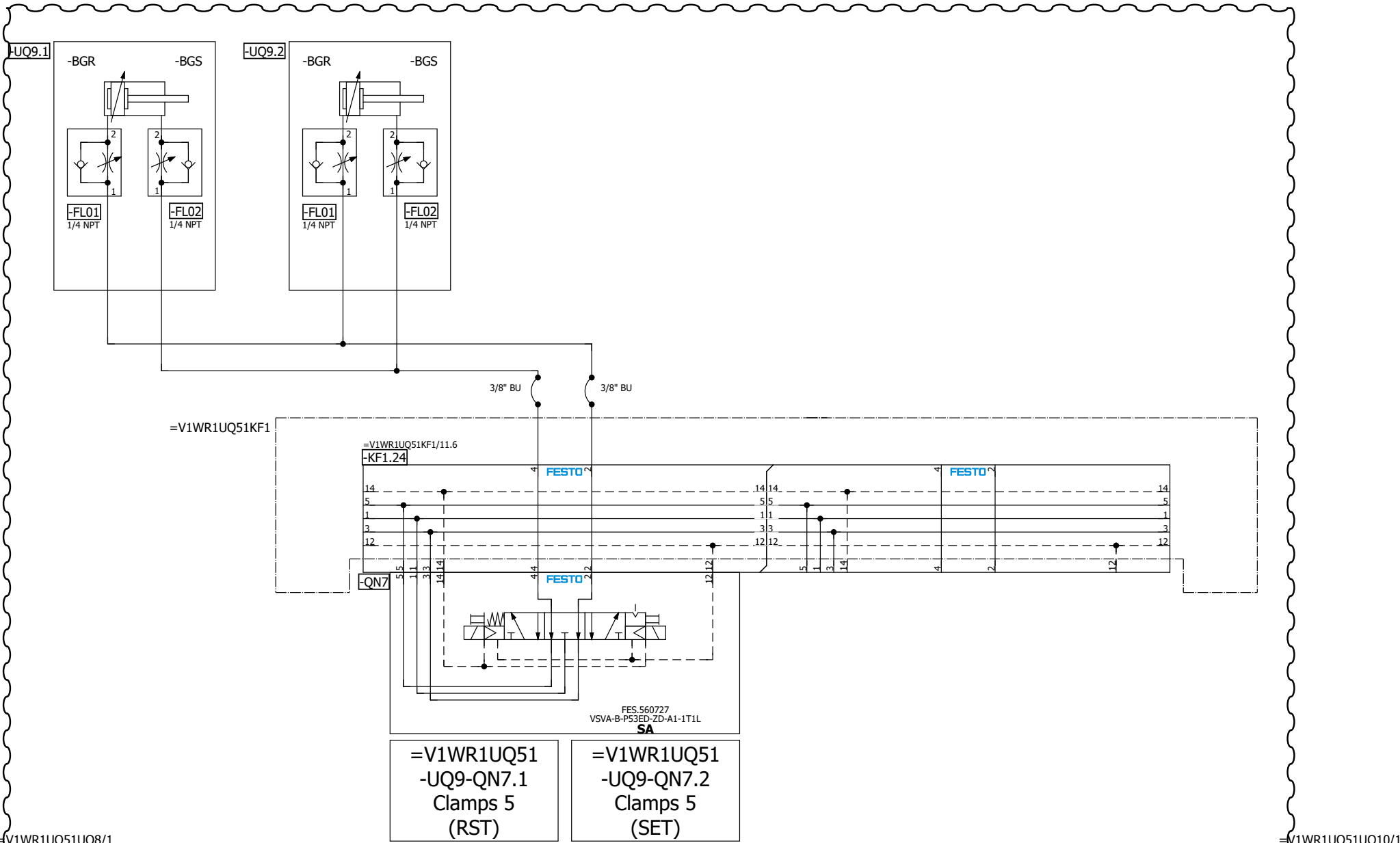

=V1WR1UQ51UQ8/1		Date	9/30/2022	Volvo Trucks North America	Valiant TMS	Clamps 5	Drawing name:	= 2V03&MFS-PNEU	= V1WR1UQ51UQ9
		Ed.	MKLEPADLO				Document type:	MFS	+ V1WR1UQ51
		Appr		P6700 Underbody Floor Skin - Cell 2V03			Project nr:	22-16151	Page
Modification	Date	Name	Original	Replacement of	Replaced by	Scale 1:1			176

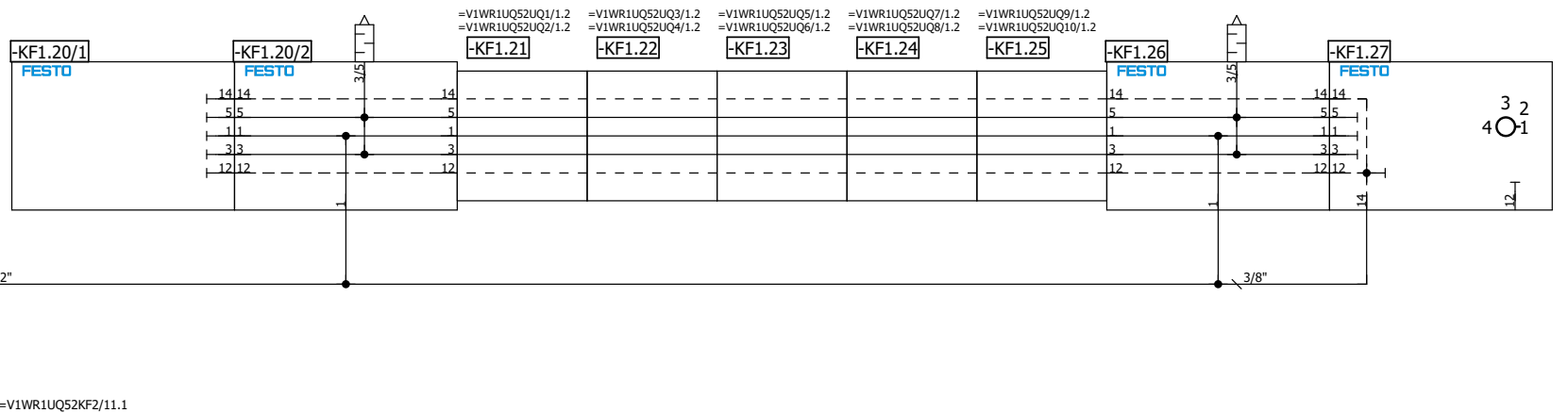
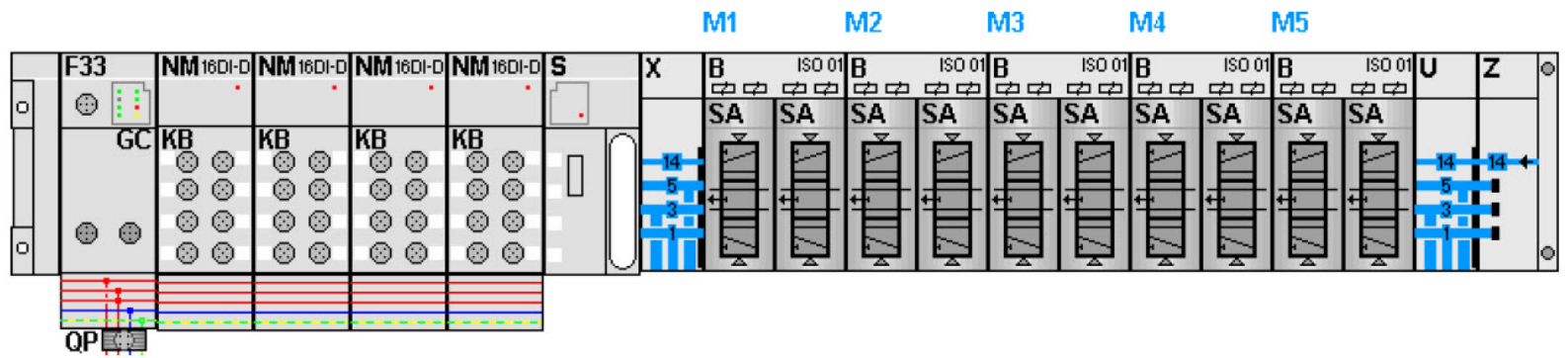

=V1WR1UQ52KF2/5

5

				Date	9/30/2022	Volvo Trucks North America	Valiant TMS	AIR SUPPLY	Drawing name: = 2V03&MFS-PNEU		= V1WR1UQ52KF1 + V1WR1UQ52
				Ed.	MKLEPADLO	P6700 Underbody Floor Skin - Cell 2V03	Scale 1:1		Document type:	Project nr:	Page
Modification	Date	Name	Original	Replacement of	Replaced by				MFS	22-16151	11
											176

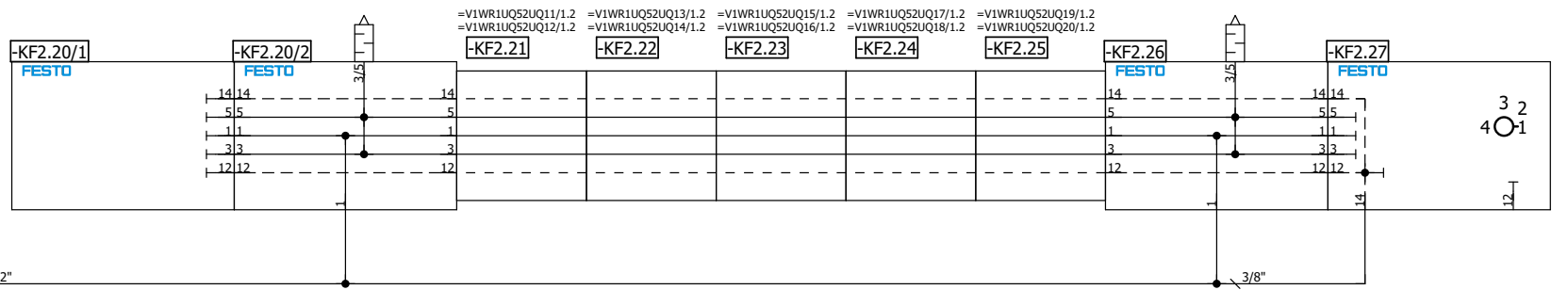
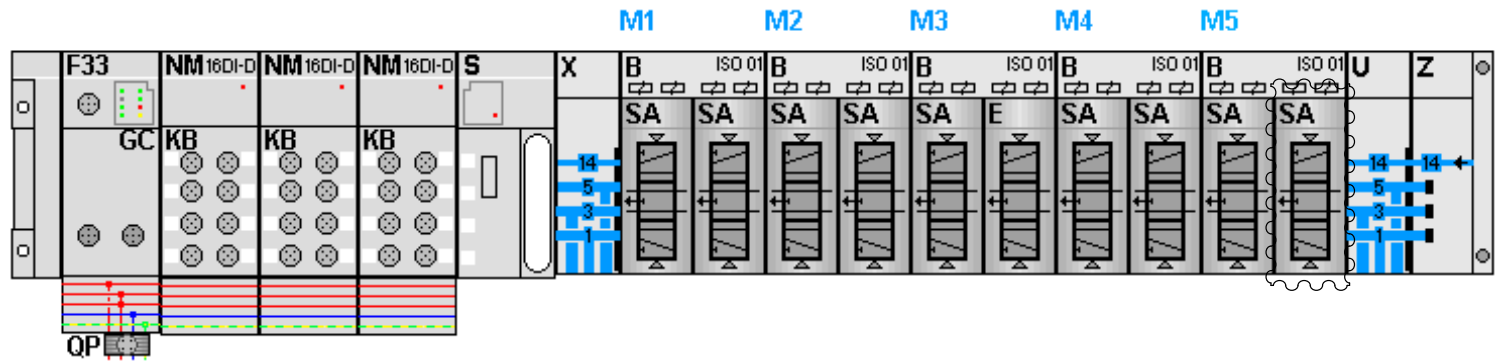

=V1WR1UQ52UQ1/1

				Date	11/16/2022	Volvo Trucks North America	Valiant TMS	AIR SUPPLY	Drawing name:	= 2V03&MFS-PNEU	= V1WR1UQ52KF2
				Ed.	KMAFFRE	P6700 Underbody Floor Skin - Cell 2V03	Scale 1:1		Document type:	MFS	+ V1WR1UQ52
Modification	Date	Name	Original	Appr					Replacement of	Replaced by	Project nr:
											176

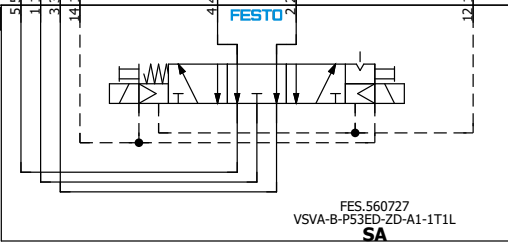
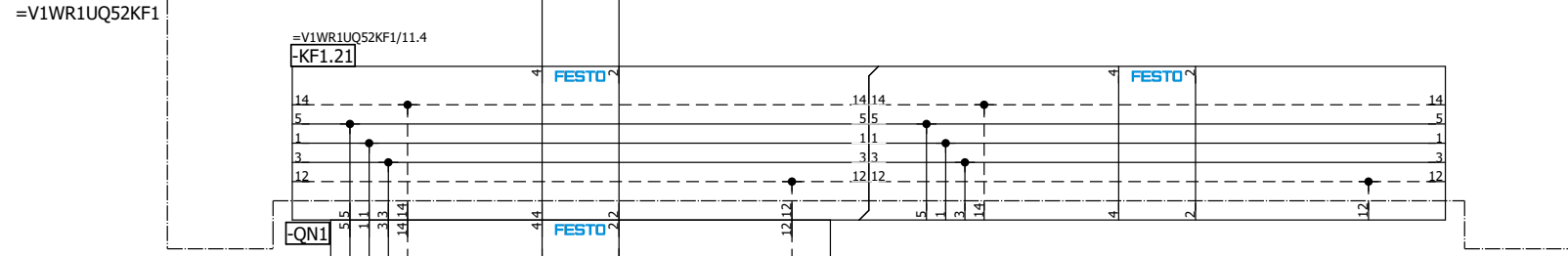
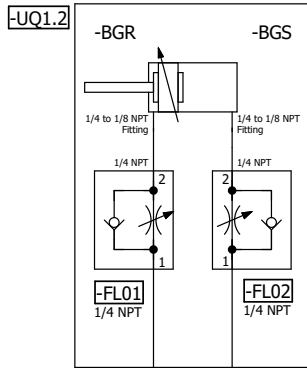
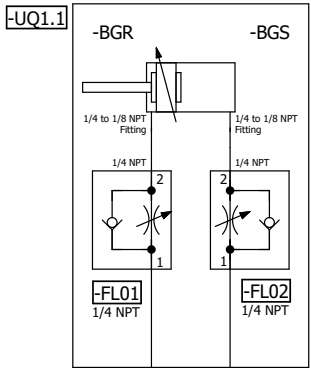

=V1WR1UQ52
 -UQ1-QN1.1
 Common
 Shot Pins (RST)

=V1WR1UQ52
 -UQ1-QN1.2
 Common
 Shot Pins (SET)

=V1WR1UQ52KF2/11

=V1WR1UQ52UQ2/1

Date	9/30/2022	Volvo Trucks North America	Valiant TMS	Common Shot Pins	Drawing name:	= 2V03&MFS-PNEU	= V1WR1UQ52UQ1
Ed.	MKLEPADLO	P6700 Underbody Floor Skin - Cell 2V03	Scale 1:1		Document type:	MFS	+ V1WR1UQ52
Appr					Project nr:	22-16151	Page
Modification	Date	Name	Original	Replacement of	Replaced by		176

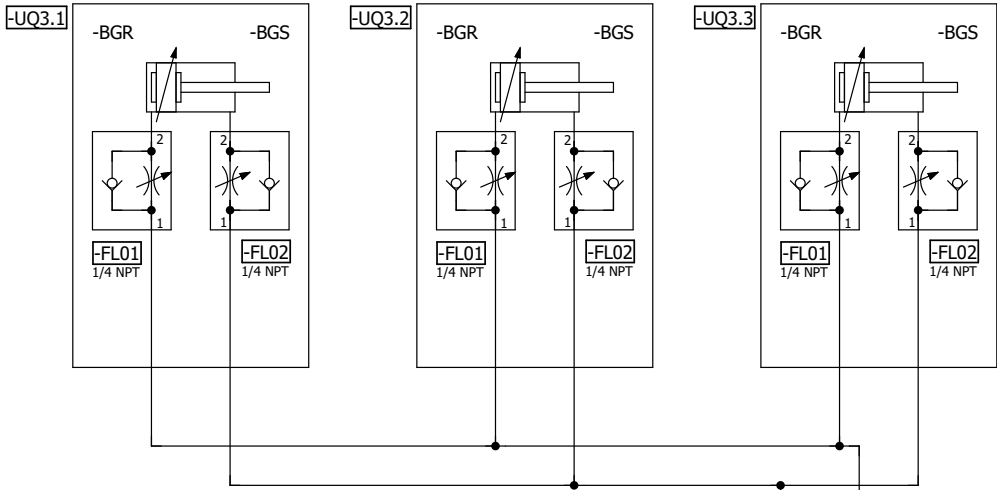

=V1WR1UQ52KF1

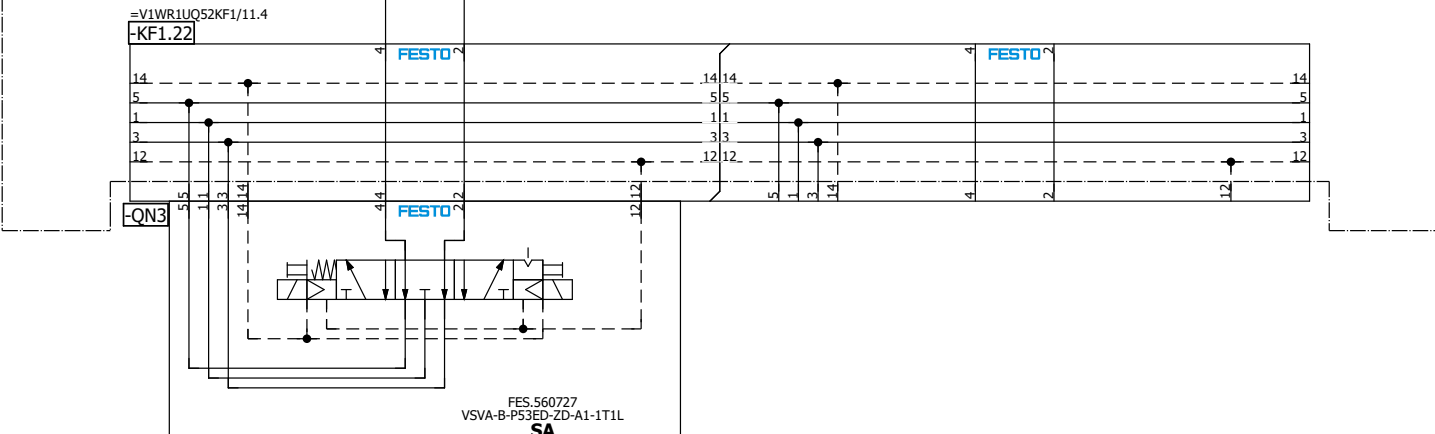

=V1WR1UQ52
-UQ3-QN3.1
Common
Clamps 2 (RST)

=V1WR1UQ52
-UQ3-QN3.2
Common
Clamps 2 (SET)

=V1WR1UQ52UQ4/1

			Date	9/30/2022	Volvo Trucks North America	Valiant TMS	Common Clamps 2	Drawing name:	= 2V03&MFS-PNEU	= V1WR1UQ52UQ3
			Ed.	MKLEPADLO		Scale 1:1		Document type:	MFS	+ V1WR1UQ52
Modification	Date	Name	Original	Replacement of				Replaced by	Project nr:	22-16151
										176

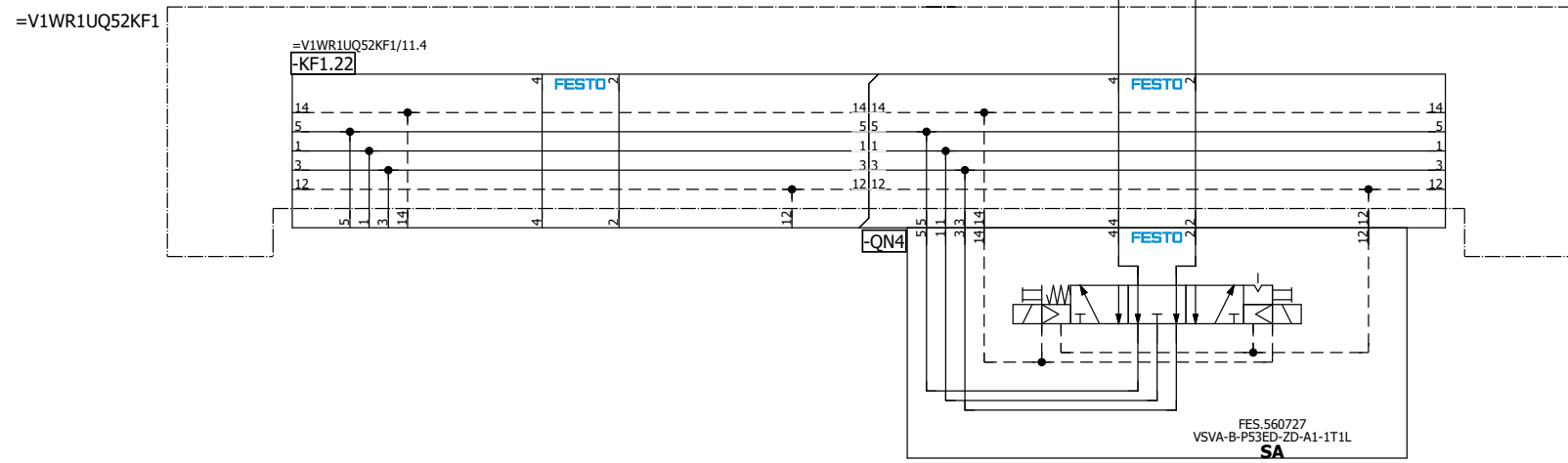
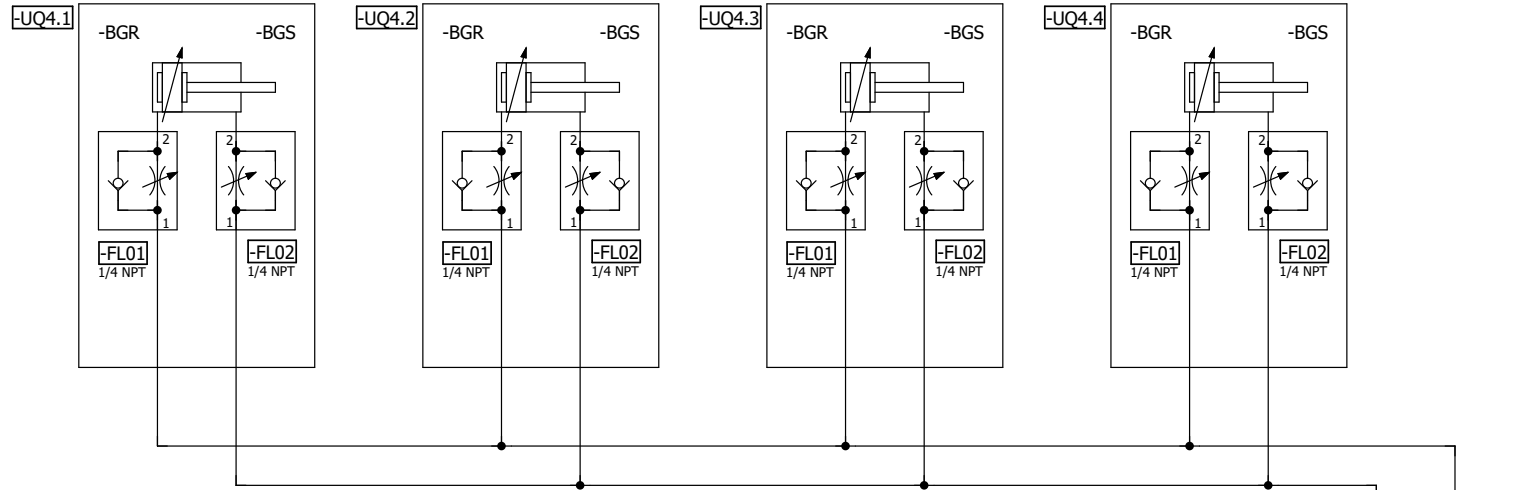

=V1WR1UQ52
-UQ4-QN4.1
L150 Model
Clamps 1 (RST)

=V1WR1UQ52
-UQ4-QN4.2
L150 Model
Clamps 1 (SET)

=V1WR1UQ52UQ3/1

=V1WR1UQ52UQ5/1

Date	9/30/2022	Volvo Trucks North America	Valiant TMS	L150 Model Clamps 1	Drawing name:	= V1WR1UQ52UQ4
Ed.	MKLEPADLO				= 2V03&MFS-PNEU	+ V1WR1UQ52
Appr		P6700 Underbody Floor Skin - Cell 2V03			Document type:	MFS
Original		Replacement of	Replaced by	Scale 1:1	Project nr:	22-16151
Modification	Date	Name	Original			Page 1
						176

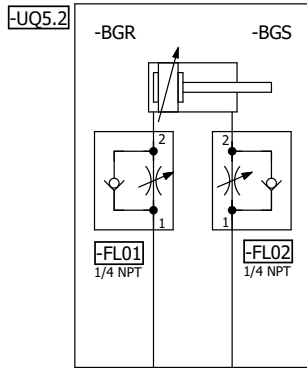
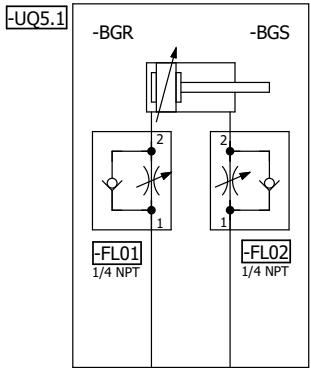

3/8" BU 3/8" BU

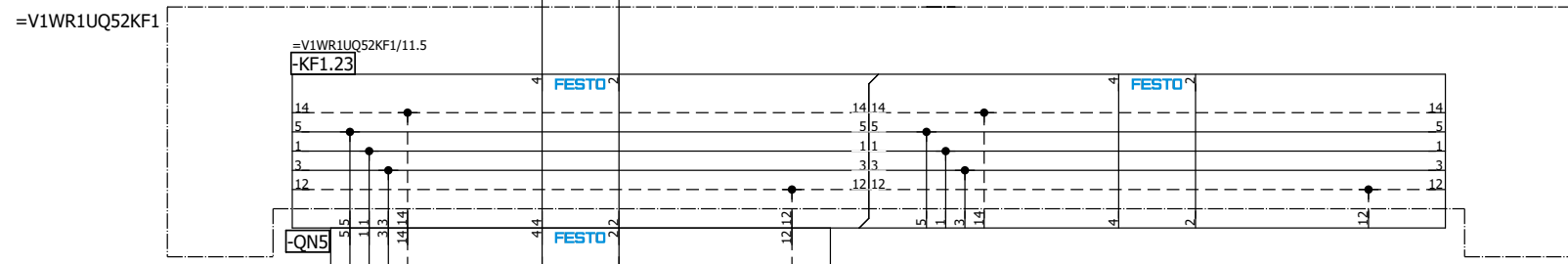

=V1WR1UQ52
-UQ5-QN5.1
 L150 Model
 Clamps 2 (RST)

=V1WR1UQ52
-UQ5-QN5.2
 L150 Model
 Clamps 2 (SET)

FES 560727
 VSVA-B-P53ED-ZD-A1-1T1L
SA

=V1WR1UQ52UQ4/1 **=V1WR1UQ52UQ6/1**

Date	11/4/2022	Volvo Trucks North America	Valiant TMS	L150 Model Clamps 2	Drawing name:	= 2V03&MFS-PNEU	= V1WR1UQ52UQ5
Ed.	KMAFFRE	P6700 Underbody Floor Skin - Cell 2V03	Scale 1:1	Replacement of	Document type:	MFS	+ V1WR1UQ52
Appr					Project nr:	22-16151	Page
Modification	Date	Name	Original	Replaced by			176

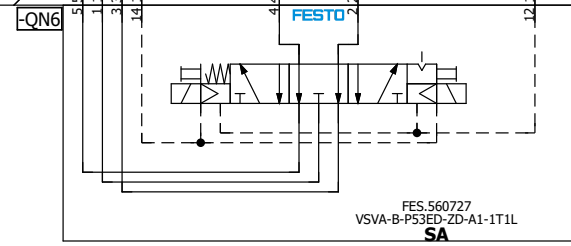
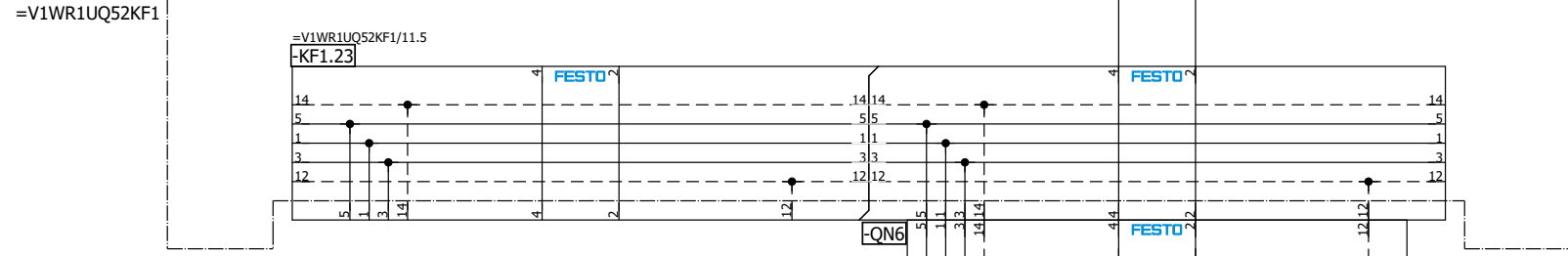
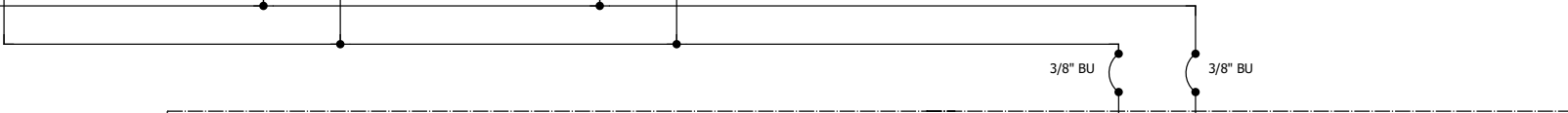
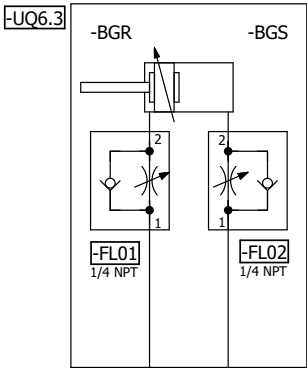
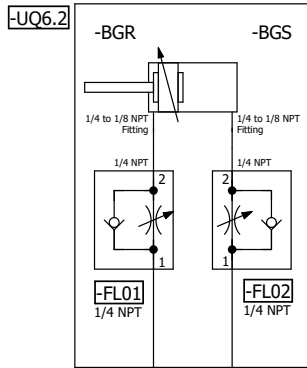
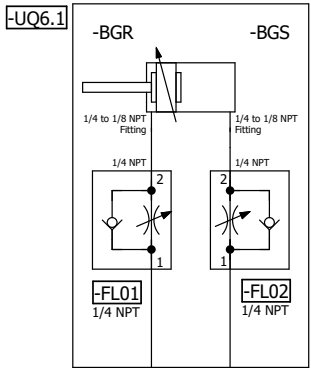

=V1WR1UQ52
-UQ6-QN6.1
L230 Model
Shot Pins (RST)

=V1WR1UQ52
-UQ6-QN6.2
L230 Model
Shot Pins (SET)

FES 560727
VSVA-B-P53ED-ZD-A1-1T1L
SA

=V1WR1UQ52UQ5/1			Date	9/30/2022	Volvo Trucks North America	Valiant TMS	L230 Model Shot Pins	Drawing name:	= 2V03&MFS-PNEU	= V1WR1UQ52UQ6	
			Ed.	MKLEPADLO				Document type:	MFS	+ V1WR1UQ52	
			Appr		P6700 Underbody Floor Skin - Cell 2V03			Project nr:	22-16151	Page	1
Modification	Date	Name	Original		Replacement of	Replaced by	Scale	1:1			176

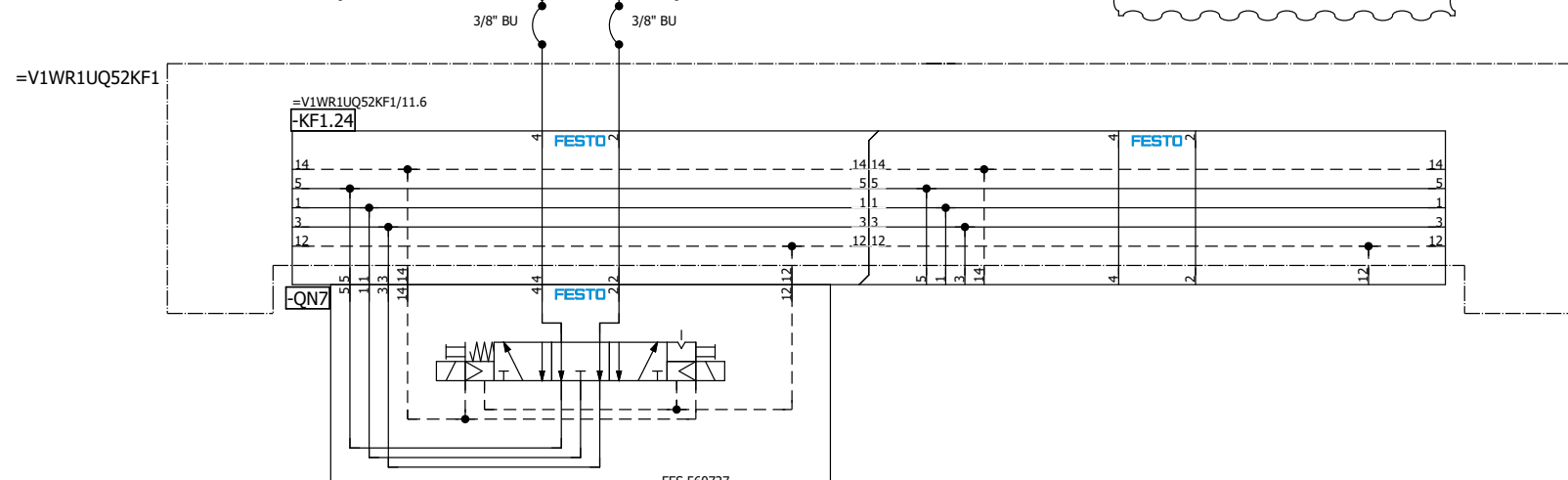
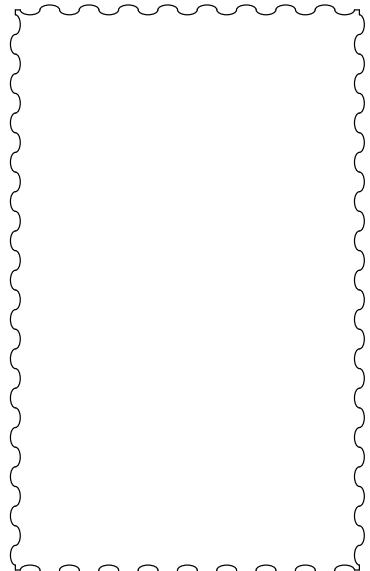
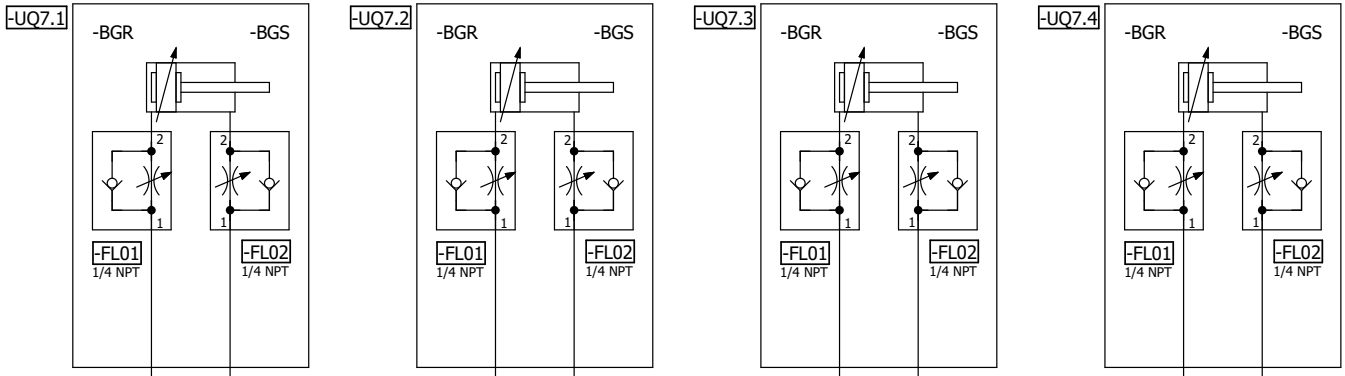

FES 560727
VSVA-B-P53ED-ZD-A1-1T1L
SA

=V1WR1UQ52
-UQ7-QN7.1
L230 Model
Clamps 1 (RST)

=V1WR1UQ52
-UQ7-QN7.2
L230 Model
Clamps 1 (SET)

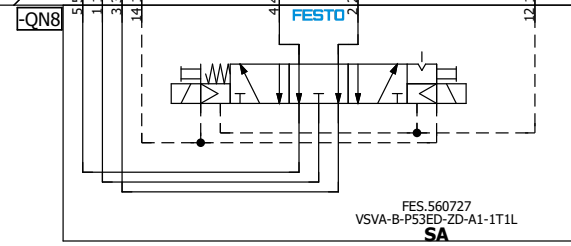
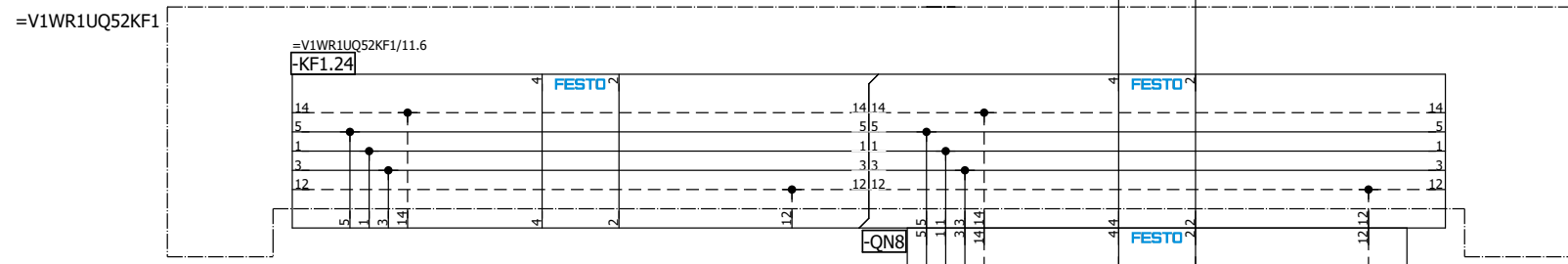
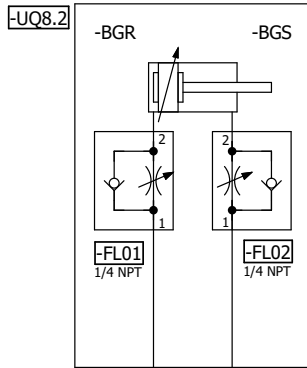
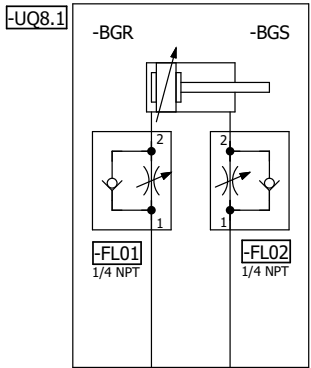

=V1WR1UQ52
-UQ8-QN8.1
L230/290/320
Clamps (RST)

=V1WR1UQ52
-UQ8-QN8.2
L230/290/320
Clamps (SET)

=V1WR1UQ52UQ7/1

=V1WR1UQ52UQ9/1

Date	9/30/2022	Volvo Trucks North America	Valiant TMS	L230/290/320 Model Clamps	Drawing name:	= 2V03&MFS-PNEU	= V1WR1UQ52UQ8
Ed.	MKLEPADLO	P6700 Underbody Floor Skin - Cell 2V03	Scale 1:1		Document type:	MFS	+ V1WR1UQ52
Appr					Project nr:	22-16151	Page
Modification	Date	Name	Original	Replacement of	Replaced by		176

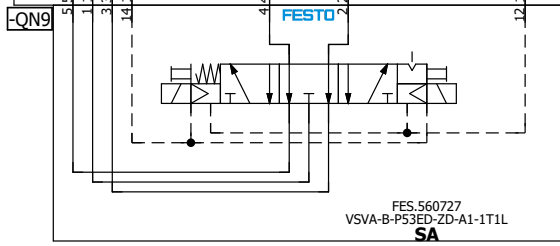
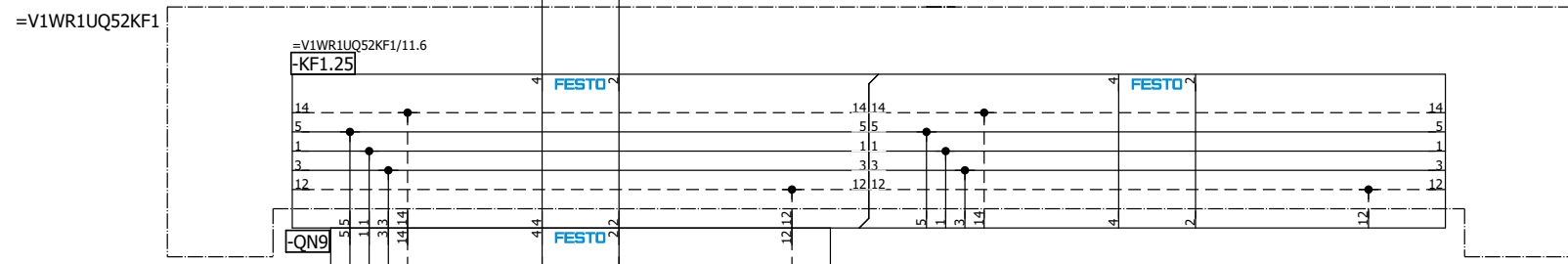
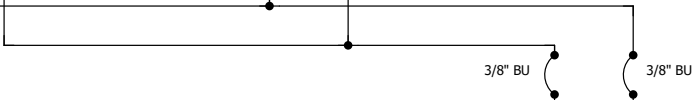
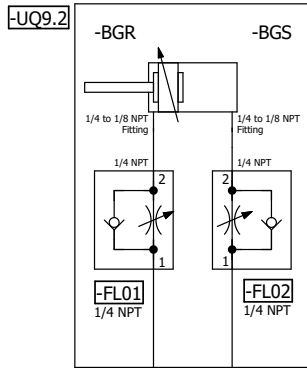
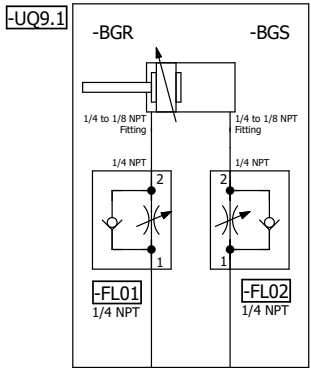

=V1WR1UQ52
-UQ9-QN9.1
L290 Model
Shot Pins (RST)

=V1WR1UQ52
-UQ9-QN9.2
L290 Model
Shot Pins (SET)

=V1WR1UQ52UQ8/1 =V1WR1UQ52UQ10/1

Date	9/30/2022	Volvo Trucks North America	Valiant TMS	L290 Model Shot Pins	Drawing name:	= 2V03&MFS-PNEU	= V1WR1UQ52UQ9
Ed.	MKLEPADLO	P6700 Underbody Floor Skin - Cell 2V03	Scale 1:1	Replacement of	Document type:	MFS	+ V1WR1UQ52
Appr					Project nr:	22-16151	Page
Modification	Date	Name	Original	Replaced by			176

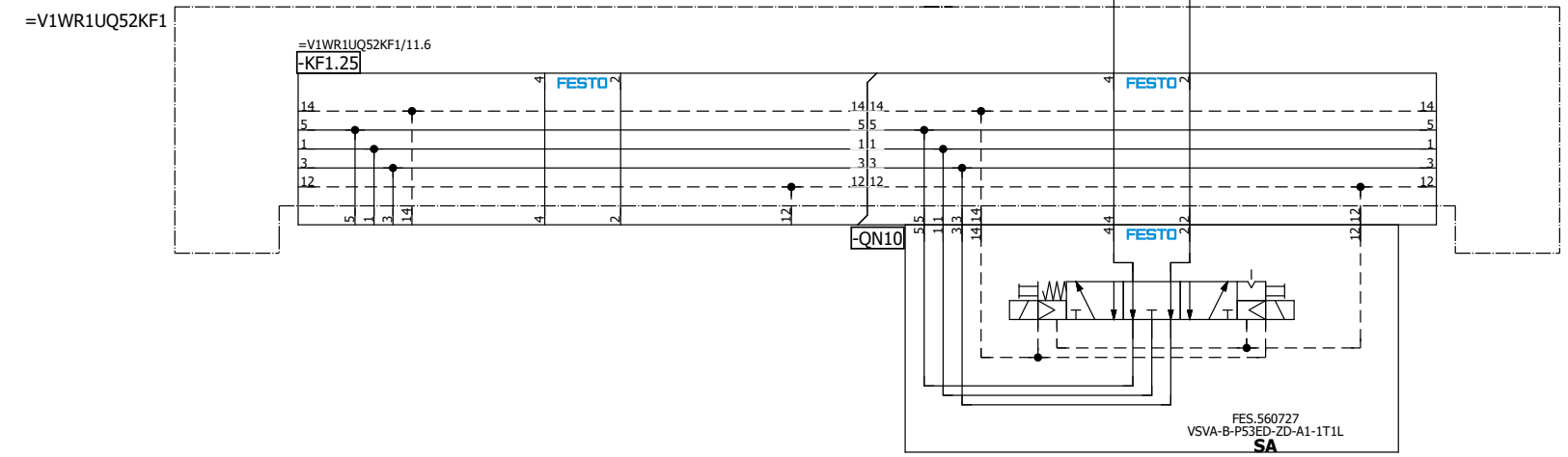
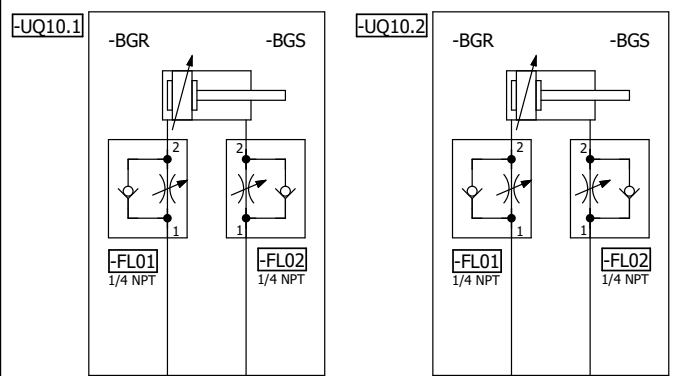

=V1WR1UQ52
-UQ10-QN10.1
L290/320 Model
Clamps 1 (RST)

=V1WR1UQ52
-UQ10-QN10.2
L290/320 Model
Clamps 1 (SET)

=V1WR1UQ52UQ11/1

		Date	9/30/2022	Volvo Trucks North America		Valiant TMS		L290/320 Model Clamps 1		Drawing name: = 2V03&MFS-PNEU		= V1WR1UQ52UQ10	
		Ed.	MKLEPADLO							Document type: MFS		+ V1WR1UQ52	
		Appr		P6700 Underbody Floor Skin - Cell 2V03						Project nr: 22-16151		Page 1	
Modification	Date	Name	Original	Replacement of	Replaced by	Scale 1:1						Page 176	

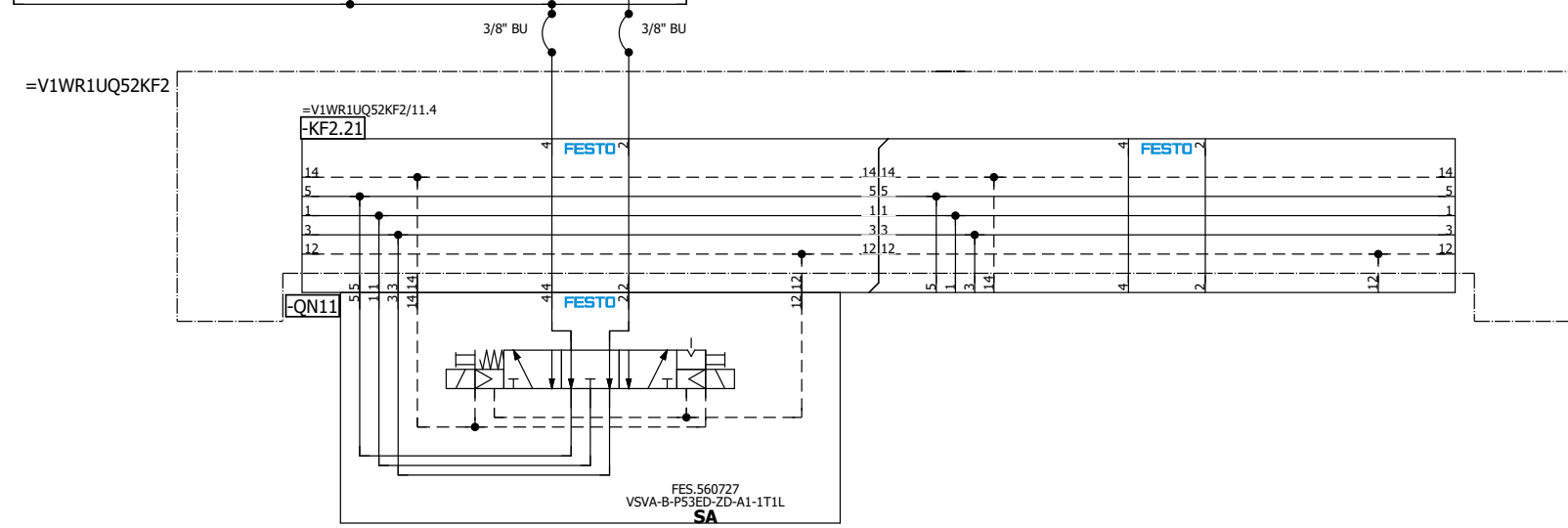
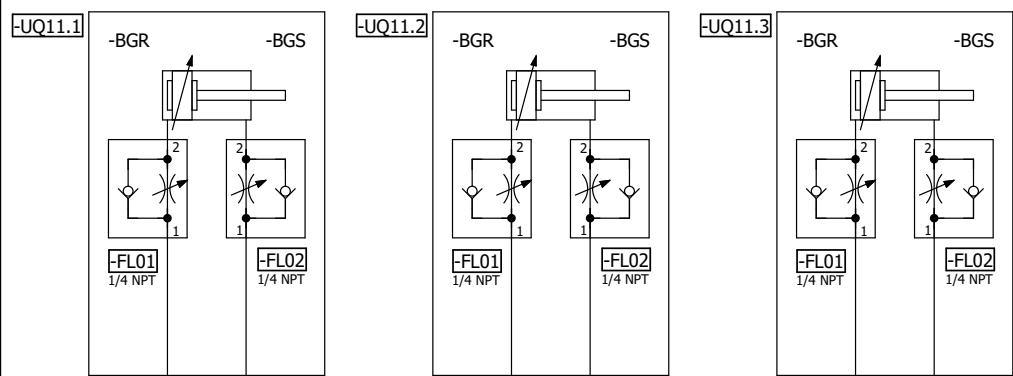

=V1WR1UQ52
-UQ11-QN11.1
L290 Model
Clamps 1 (RST)

=V1WR1UQ52
-UQ11-QN11.2
L290 Model
Clamps 1 (SET)

=V1WR1UQ52UQ10/1

=V1WR1UQ52UQ12/1

Date	9/30/2022	Volvo Trucks North America	Valiant TMS	L290 Model Clamps 1	Drawing name:	= 2V03&MFS-PNEU	= V1WR1UQ52UQ11
Ed.	MKLEPADLO	P6700 Underbody Floor Skin - Cell 2V03	Scale 1:1	Replacement of	Document type:	MFS	+ V1WR1UQ52
Appr					Project nr:	22-16151	Page
Modification	Date	Name	Original	Replaced by			176

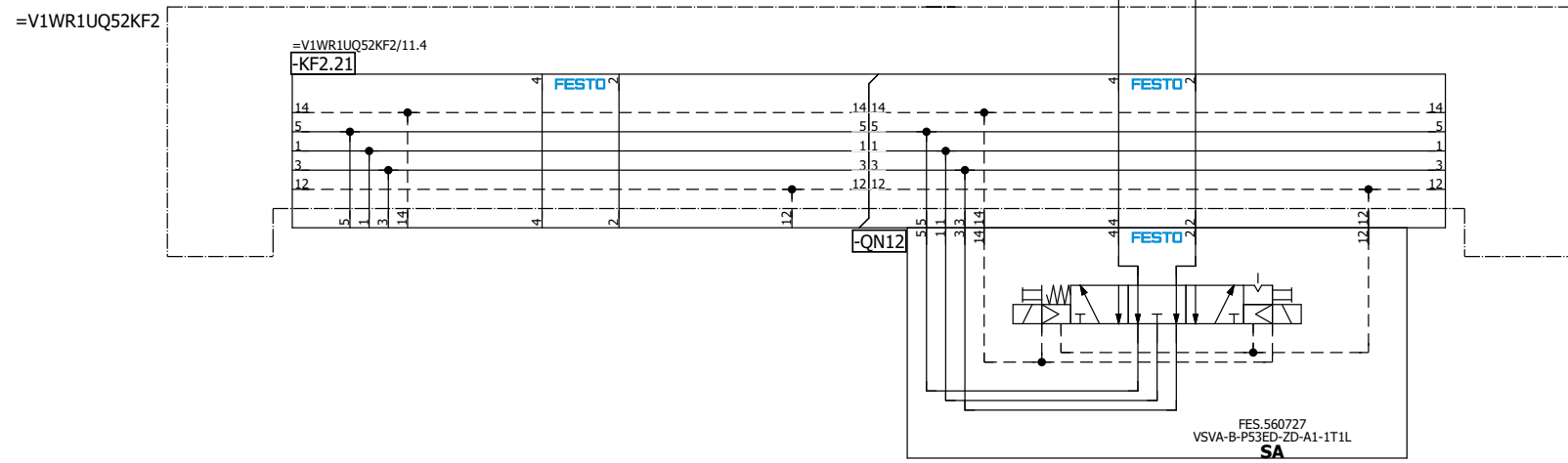
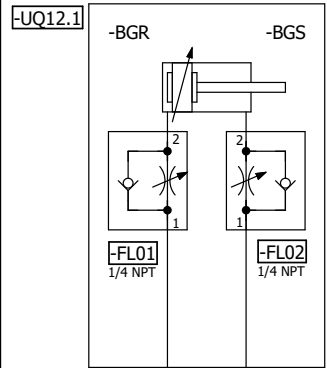

=V1WR1UQ52UQ11/1

		Date	9/30/2022	Volvo Trucks North America		Valiant TMS	L290 Model Clamp 2	Drawing name:		= V1WR1UQ52UQ12			
		Ed.	MKLEPADLO					= 2V03&MFS-PNEU		+ V1WR1UQ52			
		Appr		P6700 Underbody Floor Skin - Cell 2V03		Scale 1:1	Document type:		MFS	Project nr:	22-16151	Page	1
Modification	Date	Name	Original	Replacement of	Replaced by								176

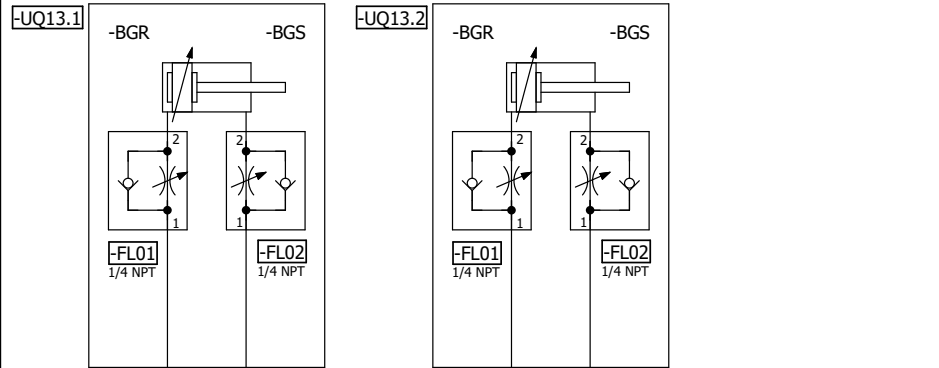

3/8" BU 3/8" BU

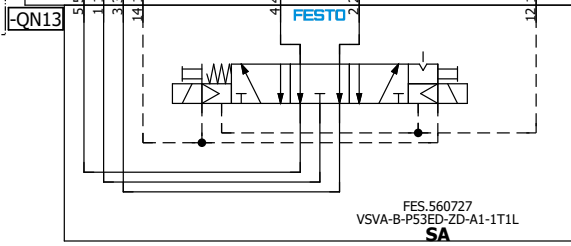
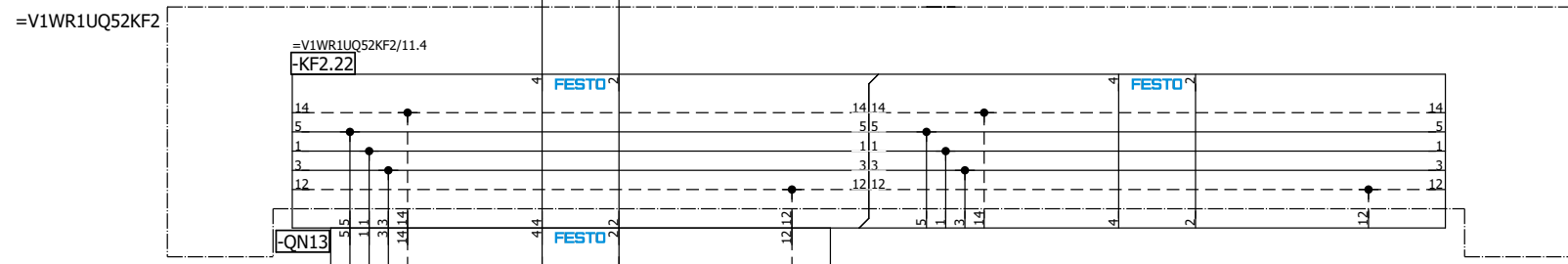

=V1WR1UQ52
-UQ13-QN13.1
L290/320 Model
Clamps 2 (RST)

=V1WR1UQ52
-UQ13-QN13.2
L290/320 Model
Clamps 2 (SET)

=V1WR1UQ52UQ12/1

=V1WR1UQ52UQ14/1

Date	9/30/2022	Volvo Trucks North America	Valiant TMS	L290/320 Model Clamps 2	Drawing name:	= 2V03&MFS-PNEU	= V1WR1UQ52UQ13
Ed.	MKLEPADLO	P6700 Underbody Floor Skin - Cell 2V03	Scale 1:1	Replacement of	Document type:	MFS	+ V1WR1UQ52
Appr					Project nr:	22-16151	Page
Modification	Date	Name	Original	Replaced by			176

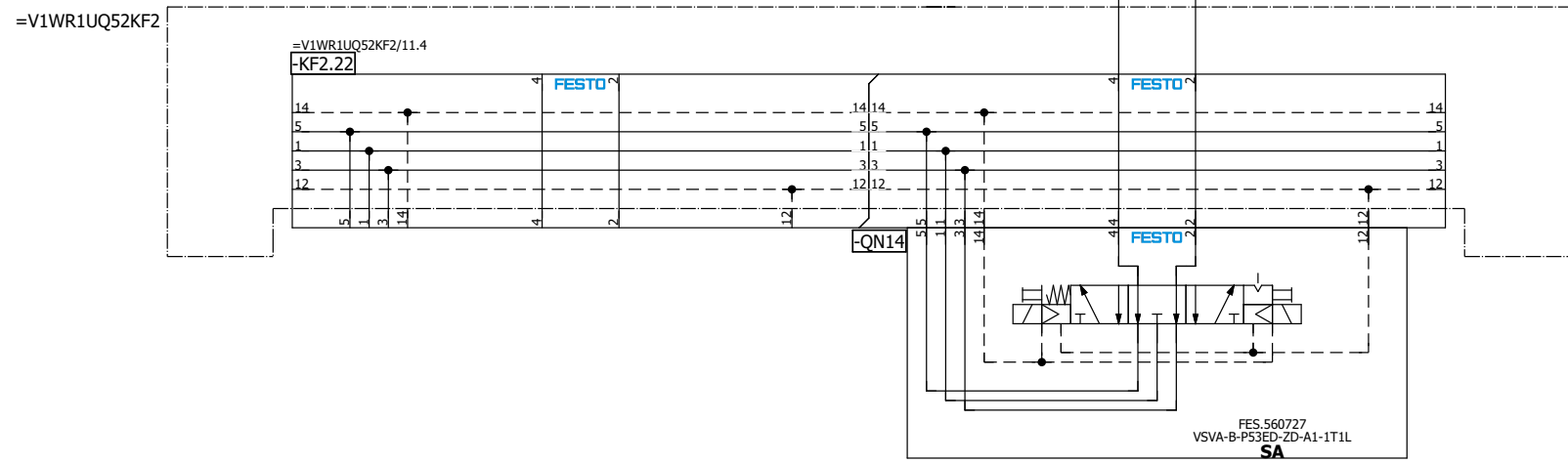
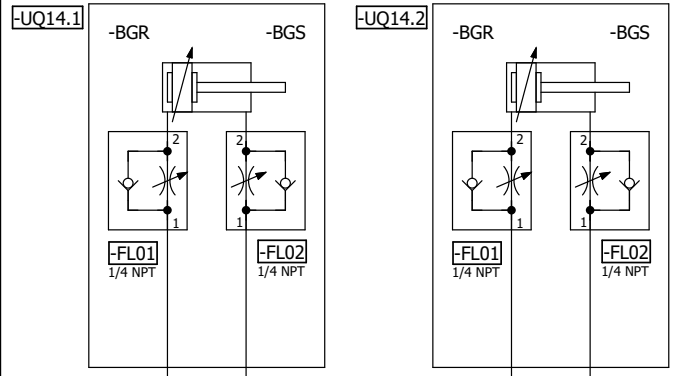

=V1WR1UQ52
-UQ14-QN14.1
L290/320 Model
Clamps 3 (RST)

=V1WR1UQ52
-UQ14-QN14.2
L290/320 Model
Clamps 3 (SET)

=V1WR1UQ52UQ13/1

=V1WR1UQ52UQ15/1

Date	9/30/2022	Volvo Trucks North America	Valiant TMS	L290/320 Model Clamps 3	Drawing name:	= 2V03&MFS-PNEU	= V1WR1UQ52UQ14
Ed.	MKLEPADLO	P6700 Underbody Floor Skin - Cell 2V03	Scale 1:1		Document type:	MFS	+ V1WR1UQ52
Appr					Project nr:	22-16151	Page
Modification	Date	Name	Original	Replacement of	Replaced by		176

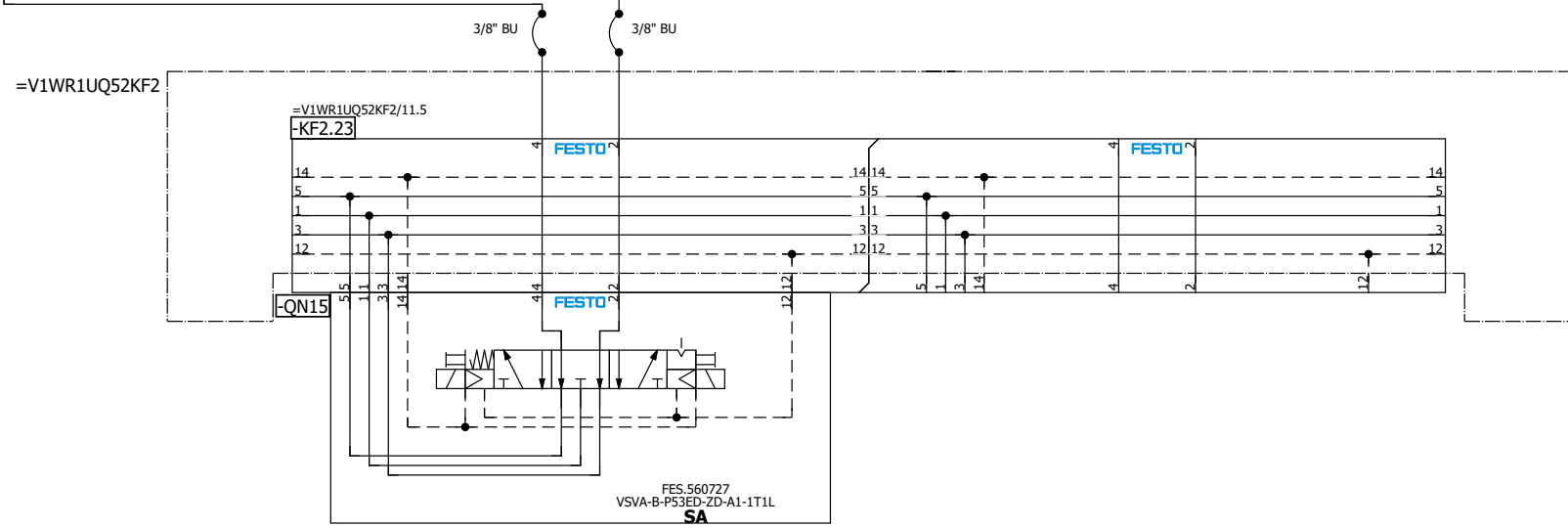
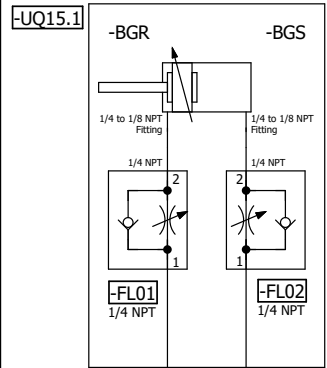

=V1WR1UQ52
-UQ15-QN15.1
L290/320 Model
Pos. Lock (RST)

=V1WR1UQ52
-UQ15-QN15.2
L290/320 Model
Pos. Lock (SET)

=V1WR1UQ52UQ14/1

=V1WR1UQ52UQ16/1

Date	9/30/2022	Volvo Trucks North America	Valiant TMS	L290/320 Model Position Lock	Drawing name:	= 2V03&MFS-PNEU	= V1WR1UQ52UQ15
Ed.	MKLEPADLO	P6700 Underbody Floor Skin - Cell 2V03	Scale 1:1	Replacement of	Document type:	MFS	+ V1WR1UQ52
Appr					Project nr:	22-16151	Page
Modification	Date	Name	Original	Replaced by			176

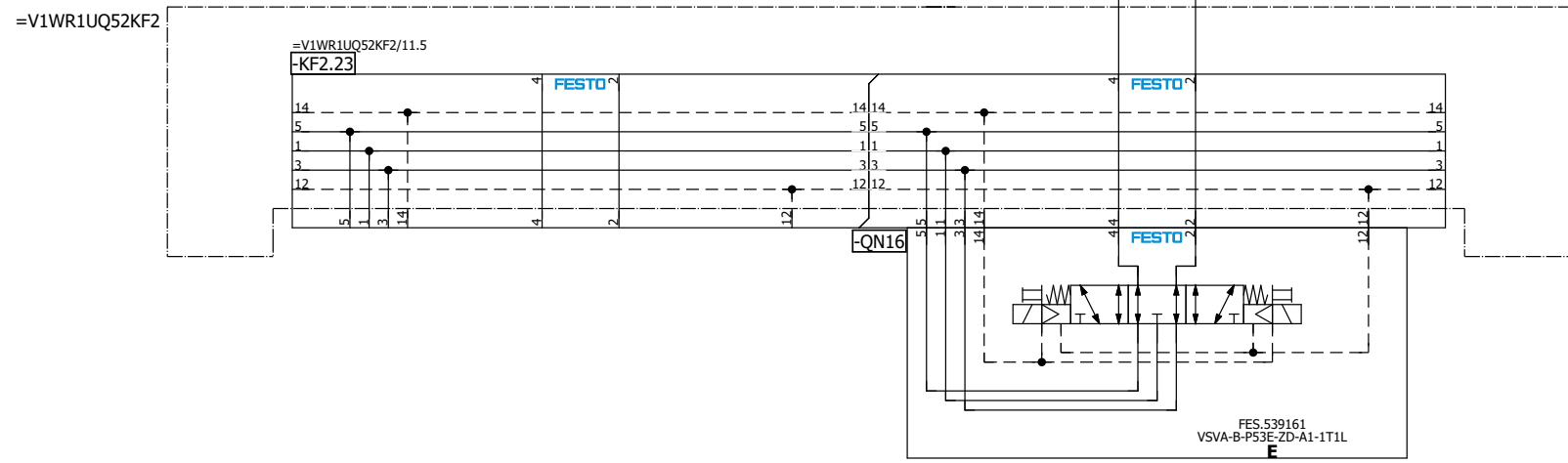
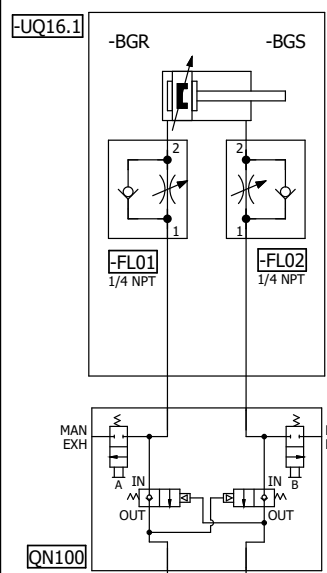

=V1WR1UQ52
-UQ16-QN16.1
L290/320 Model
Slide (RST)

=V1WR1UQ52
-UQ16-QN16.2
L290/320 Model
Slide (SET)

=V1WR1UQ52UQ15/1

=V1WR1UQ52UQ17/1

Date	11/7/2022	Volvo Trucks North America	Valiant TMS	L290/320 Model Slide	Drawing name:	= V1WR1UQ52UQ16
Ed.	MKLEPADLO				= 2V03&MFS-PNEU	+ V1WR1UQ52
Appr		P6700 Underbody Floor Skin - Cell 2V03			Document type:	MFS
Modification	Date	Name	Original	Replacement of	Replaced by	Scale 1:1
						Project nr:
						22-16151
						Page
						1
						176

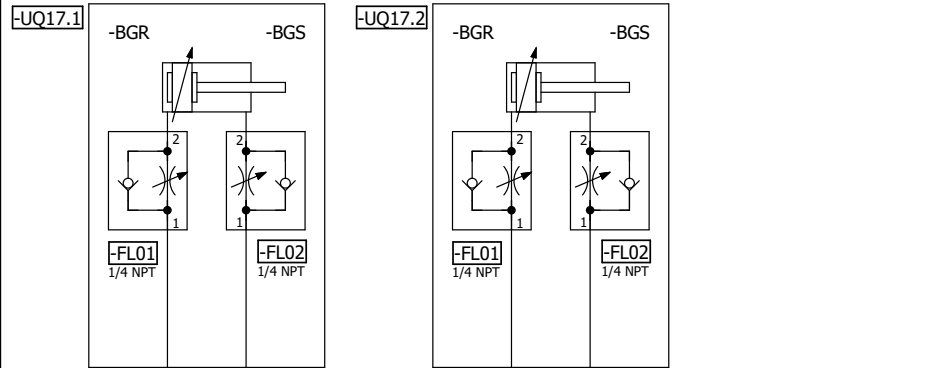

3/8" BU 3/8" BU

=V1WR1UQ52KF2

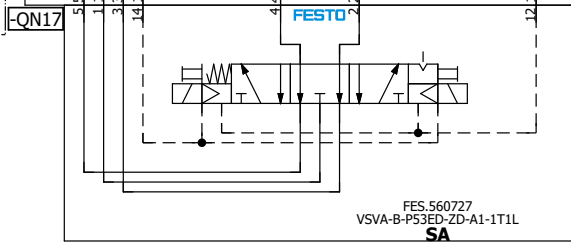
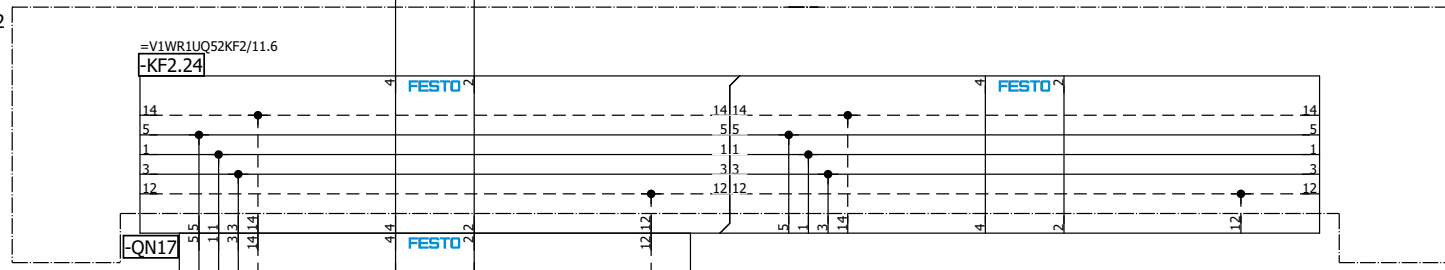

=V1WR1UQ52
-UQ17-QN17.1
L320 Model
Clamps 1 (RST)

=V1WR1UQ52
-UQ17-QN17.2
L320 Model
Clamps 1 (SET)

=V1WR1UQ52UQ16/1

=V1WR1UQ52UQ18/1

Date	9/30/2022	Volvo Trucks North America	Valiant TMS	L320 Model Clamps 1	Drawing name:	= 2V03&MFS-PNEU	= V1WR1UQ52UQ17
Ed.	MKLEPADLO	P6700 Underbody Floor Skin - Cell 2V03	Scale 1:1	Replacement of	Document type:	MFS	+ V1WR1UQ52
Appr					Project nr:	22-16151	Page
Modification	Date	Name	Original	Replaced by			176

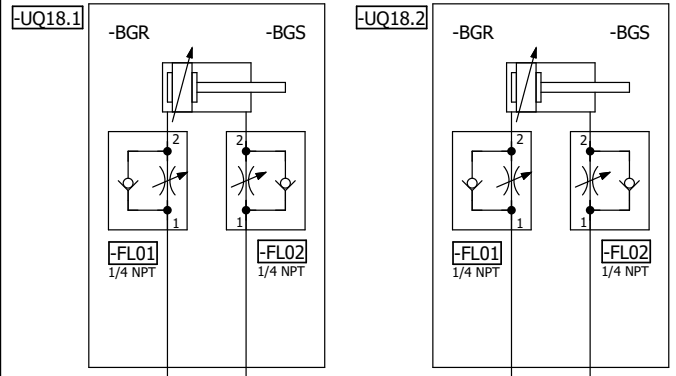

=V1WR1UQ52KF2

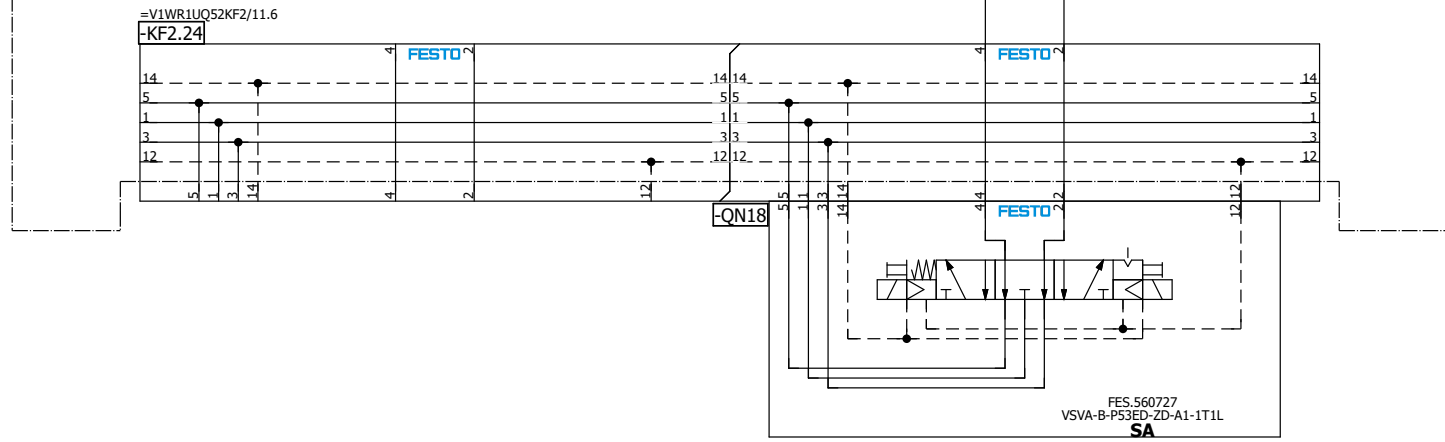

=V1WR1UQ52
-UQ18-QN18.1
L320 Model
Clamps 2 (RST)

=V1WR1UQ52
-UQ18-QN18.2
L320 Model
Clamps 2 (SET)

=V1WR1UQ52UQ19/1

=V1WR1UQ52UQ17/1

Date	9/30/2022	Volvo Trucks North America	Valiant TMS	L320 Model Clamps 2	Drawing name:	= 2V03&MFS-PNEU	= V1WR1UQ52UQ18
Ed.	MKLEPADLO	P6700 Underbody Floor Skin - Cell 2V03	Scale 1:1		Document type:	MFS	+ V1WR1UQ52
Appr					Project nr:	22-16151	Page
Modification	Date	Name	Original	Replacement of	Replaced by		176

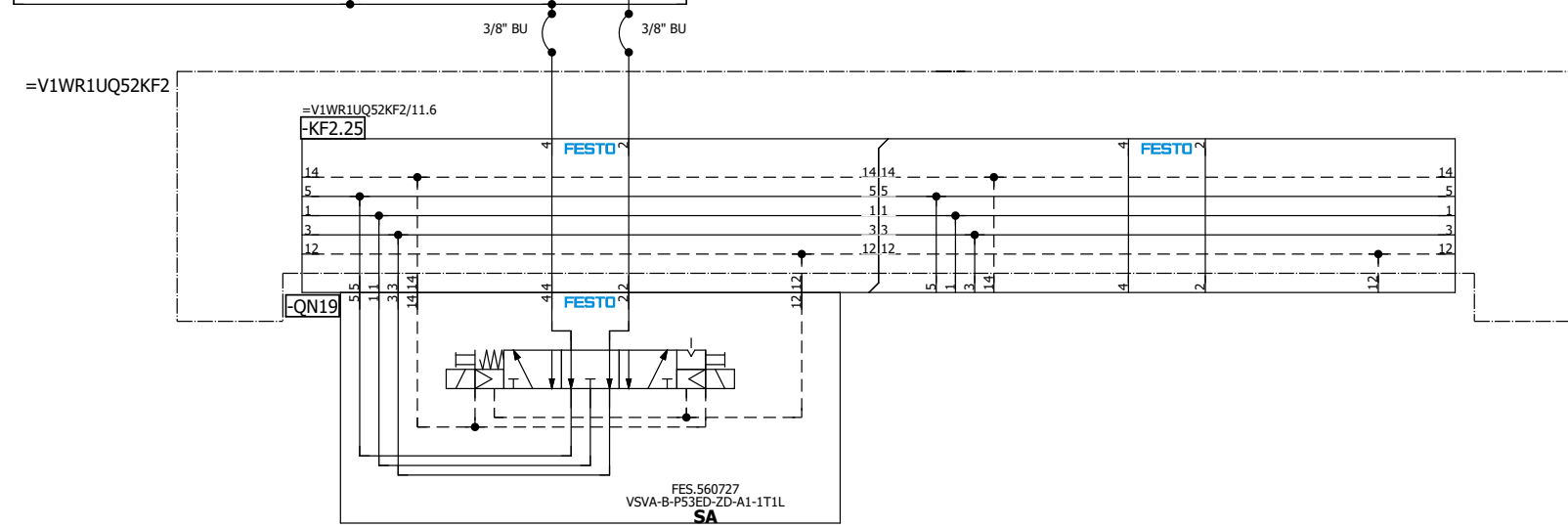
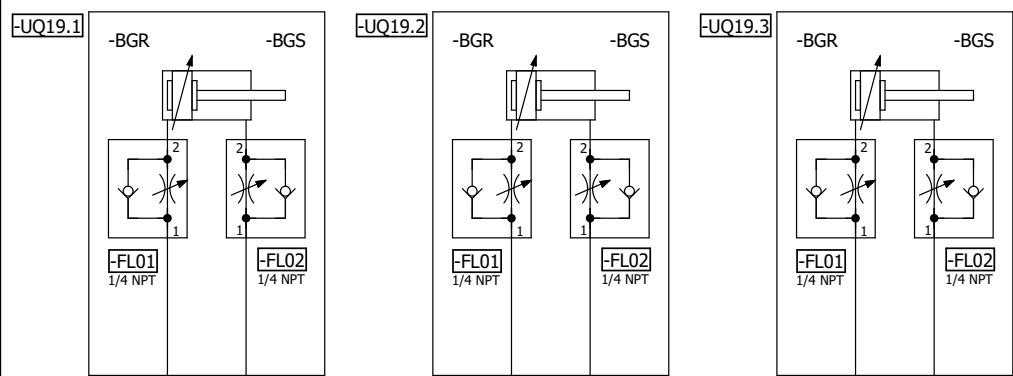

=V1WR1UQ52
-UQ19-QN19.1
L320 Model
Clamps 3 (RST)

=V1WR1UQ52
-UQ19-QN19.2
L320 Model
Clamps 3 (SET)

=V1WR1UQ52UQ18/1

=V1WR1UQ52UQ20/1

Date	9/30/2022	Volvo Trucks North America	Valiant TMS	L320 Model Clamps 3	Drawing name:	= 2V03&MFS-PNEU	= V1WR1UQ52UQ19	
Ed.	MKLEPADLO	P6700 Underbody Floor Skin - Cell 2V03	Scale 1:1		Document type:	MFS	+ V1WR1UQ52	
Appr					Project nr:	22-16151	Page	1
Modification	Date	Name	Original	Replacement of	Replaced by		Page	176

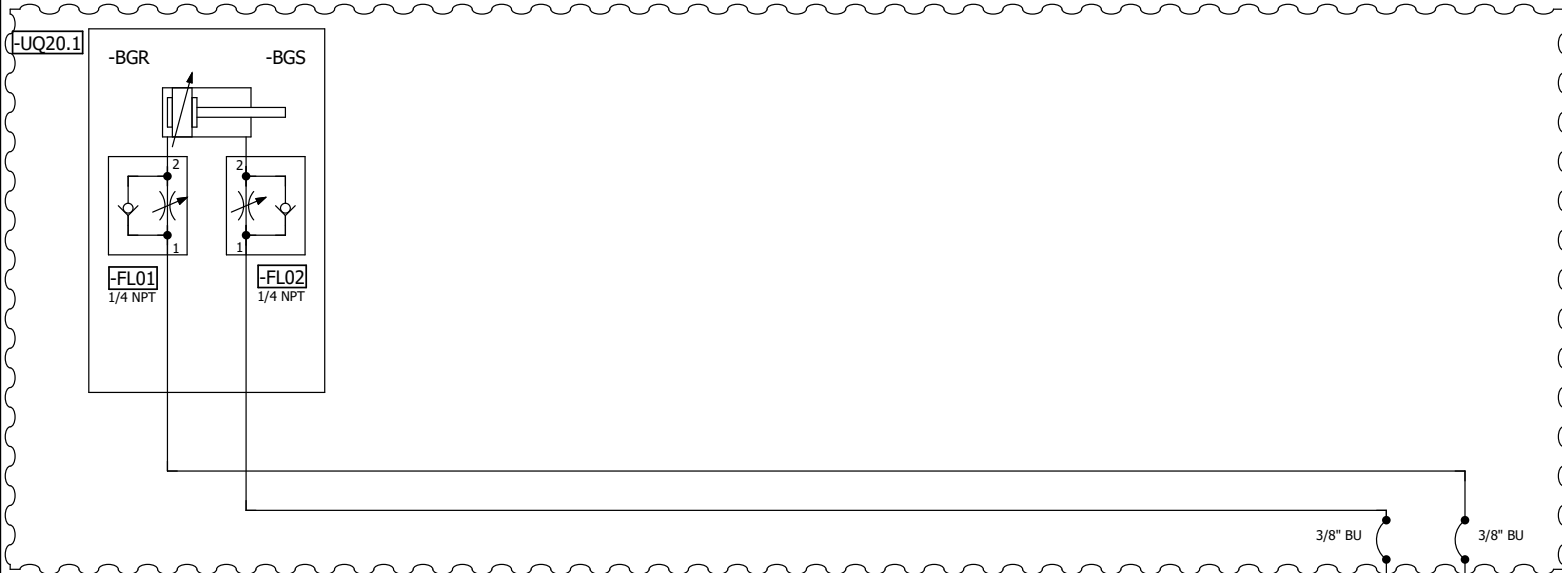

=V1WR1UQ52KF2

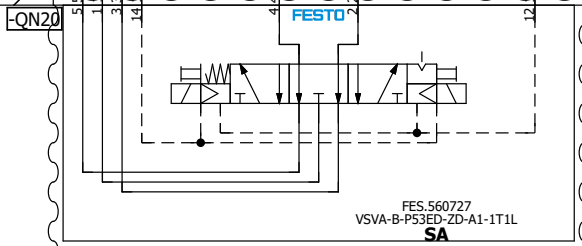
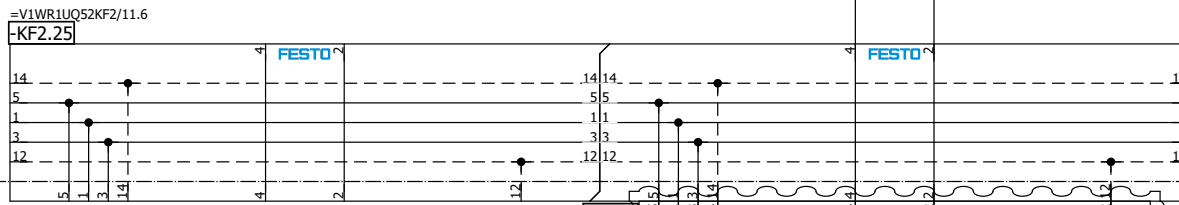

=V1WR1UQ52
-UQ20-QN20.1
L230 Model
Clamp 2 (RST)

=V1WR1UQ52
-UQ20-QN20.2
L230 Model
Clamp 2 (SET)

=V2WR1+KH1/1

=V1WR1UQ52UQ19/1

Date	11/16/2022	Volvo Trucks North America	Valiant TMS	L230 Model Clamp 2	Drawing name:	= V1WR1UQ52UQ20		
Ed.	KMAFFRE	P6700 Underbody Floor Skin - Cell 2V03	Scale 1:1		= 2V03&MFS-PNEU	+ V1WR1UQ52		
Appr					Document type:	Project nr:	Page	1
Modification	Date	Name	Original	Replacement of	Replaced by	MFS	22-16151	176

A2

=KH0+KH0/1.7 / +V2WR1KH1-P1

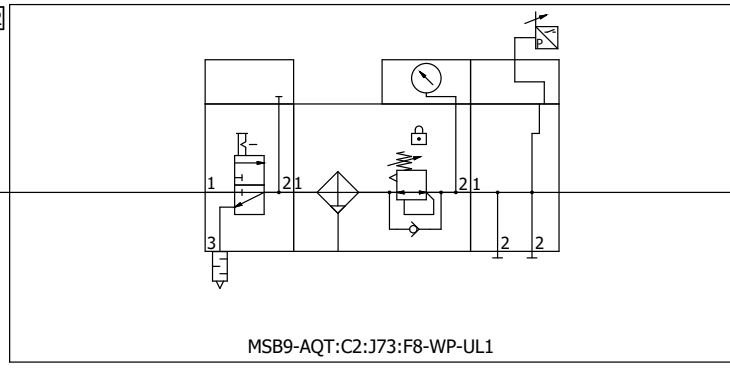

MSB9-AQT:C2:J73:F8-WP-UL1

1"

Turn table slip ring

1/2"

+V2WR1UQ51-P1 / =V2WR1UQ51KF1+V2WR1UQ51/11.0

1/2"

+V2WR1UQ52-P1 /
FUTURE

=V1WR1UQ52UQ20+V1WR1UQ52/1

=V2WR1UQ51KF1+V2WR1UQ51/5

				Date	10/31/2022	Volvo Trucks North America			Valiant TMS	Incoming air supply (Turn Table)	Drawing name:		= V2WR1
				Ed.	KMAFFRE	P6700 Underbody Floor Skin - Cell 2V03			Scale 1:1		= 2V03&MFS-PNEU		+ KH1
Modification	Date	Name	Original	Appr		Replacement of	Replaced by				Document type:	Project nr:	Page
											MFS	22-16151	1
													176

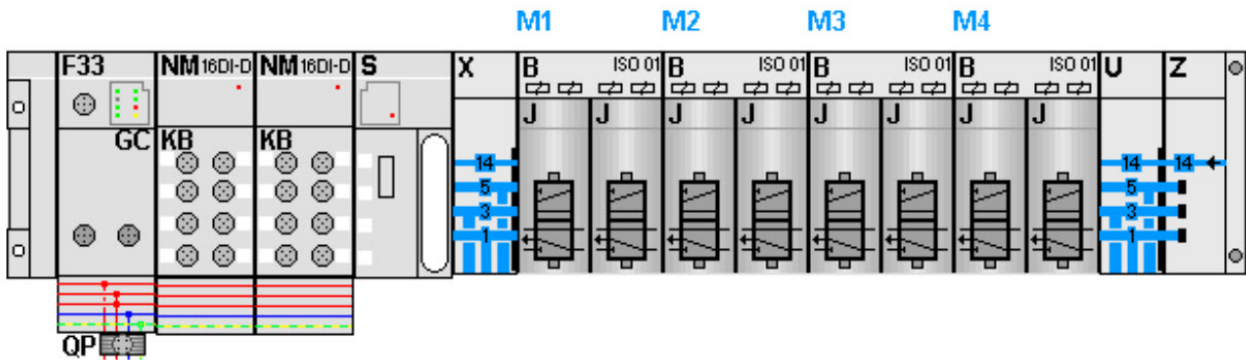

KF1.0

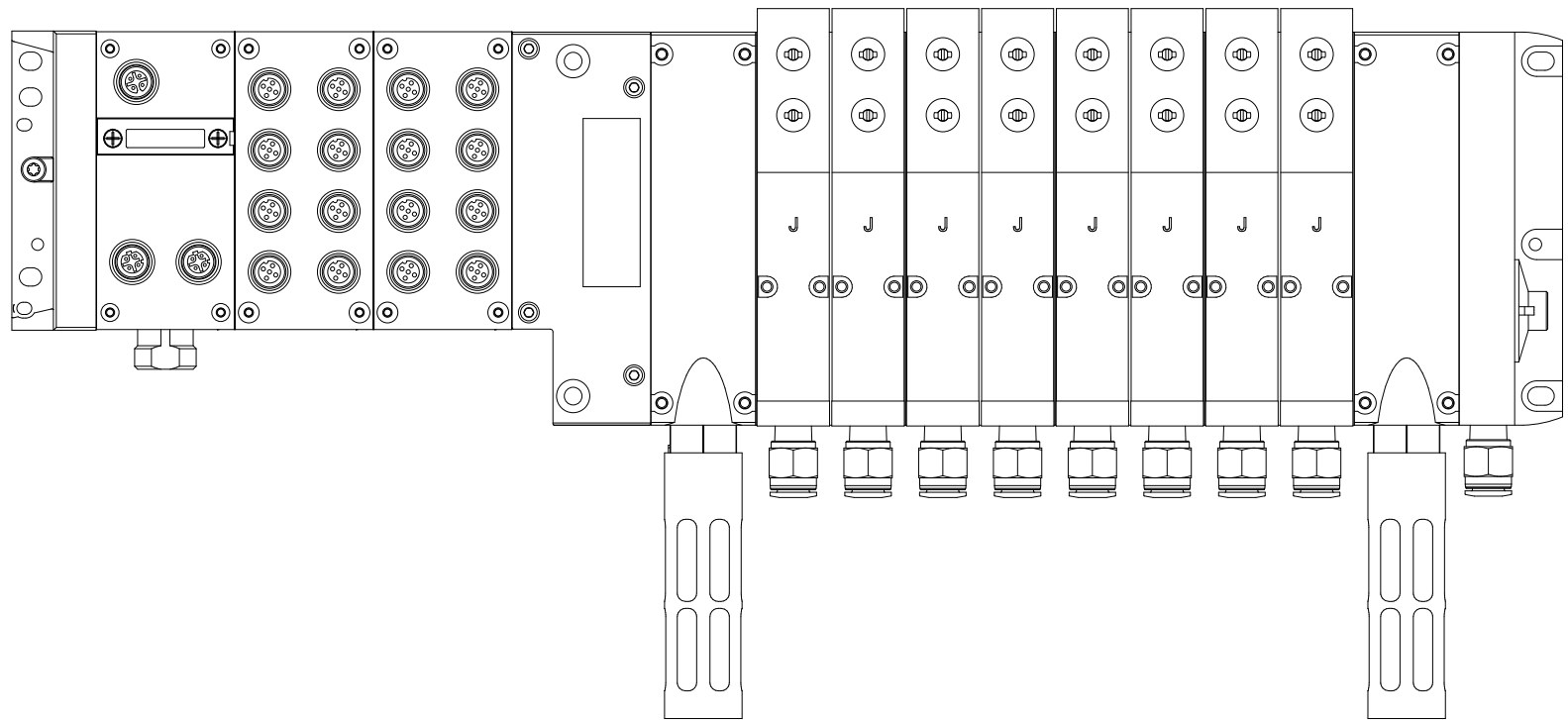

=V2WR1+KH1/1

		Date	9/30/2022	Volvo Trucks North America		Valiant TMS	AIR SUPPLY CONFIGURATION	Drawing name:		= V2WR1UQ51KF1
		Ed.	MKLEPADLO					= 2V03&MFS-PNEU		+ V2WR1UQ51
		Appr		P6700 Underbody Floor Skin - Cell 2V03		Scale 1:1	Document type:		Project nr:	Page
Modification	Date	Name	Original	Replacement of	Replaced by		MFS		22-16151	5
										176

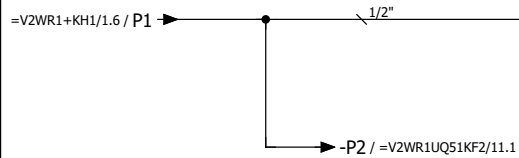
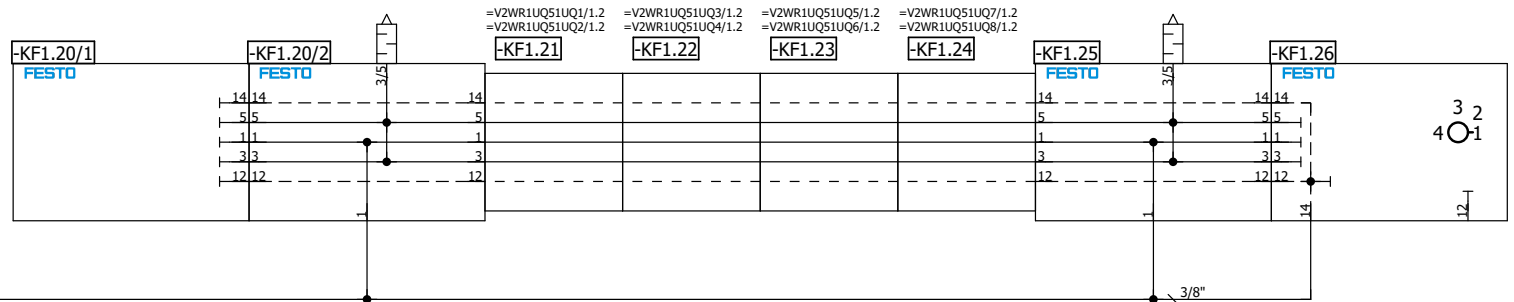
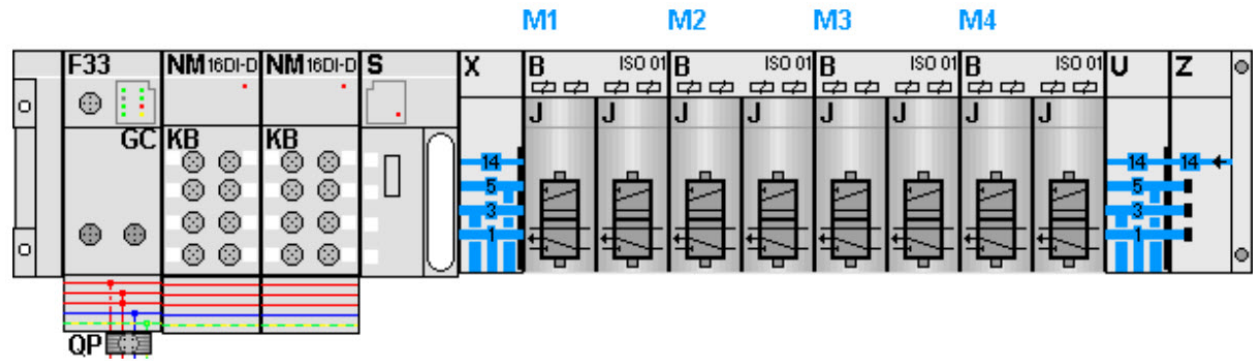

=V2WR1UQ51KF2/5

		Date	9/30/2022	Volvo Trucks North America	Valiant TMS	AIR SUPPLY	Drawing name:		= V2WR1UQ51KF1			
		Ed.	MKLEPADLO				= 2V03&MFS-PNEU		+ V2WR1UQ51			
		Appr		P6700 Underbody Floor Skin - Cell 2V03	Scale 1:1	Document type:		MFS	Project nr:	22-16151	Page	11
Modification	Date	Name	Original	Replacement of		Replaced by						176

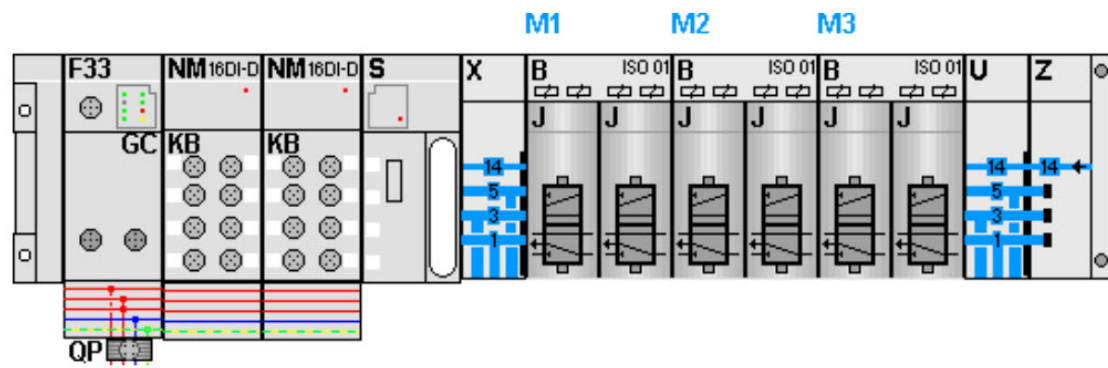

KF2.0

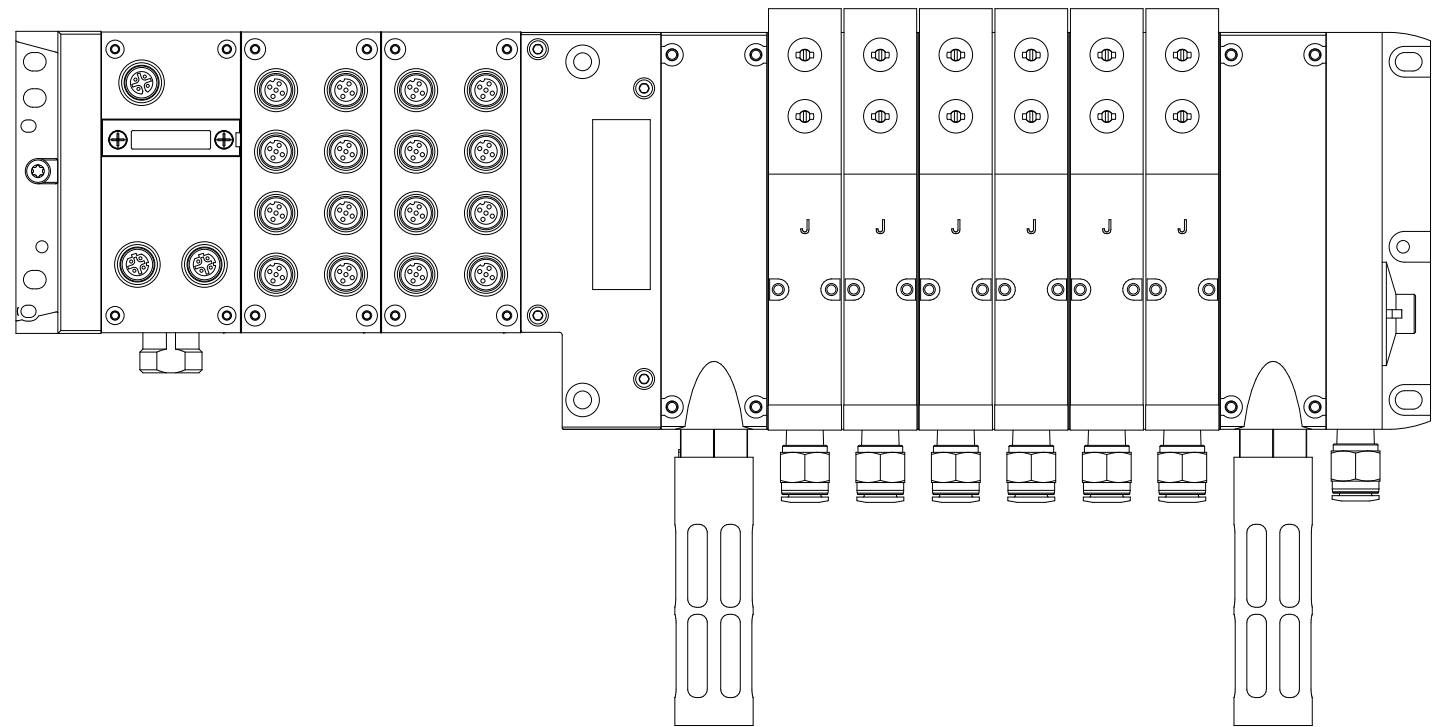

=V2WR1UQ51KF1/11

		Date	9/30/2022	Volvo Trucks North America		Valiant TMS	AIR SUPPLY CONFIGURATION	Drawing name:		= V2WR1UQ51KF2
		Ed.	MKLEPADLO					= 2V03&MFS-PNEU		+ V2WR1UQ51
		Appr		P6700 Underbody Floor Skin - Cell 2V03		Scale 1:1	Document type:		Project nr:	Page
Modification	Date	Name	Original	Replacement of	Replaced by		MFS		22-16151	5
									176	

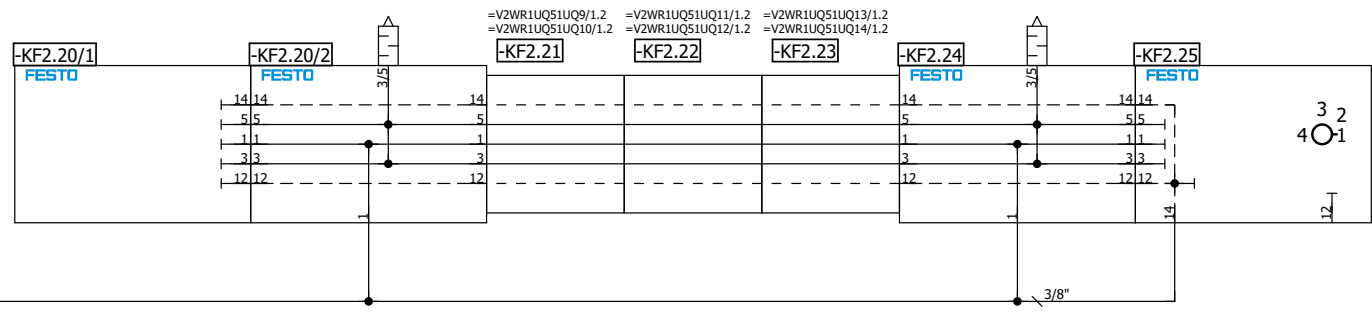
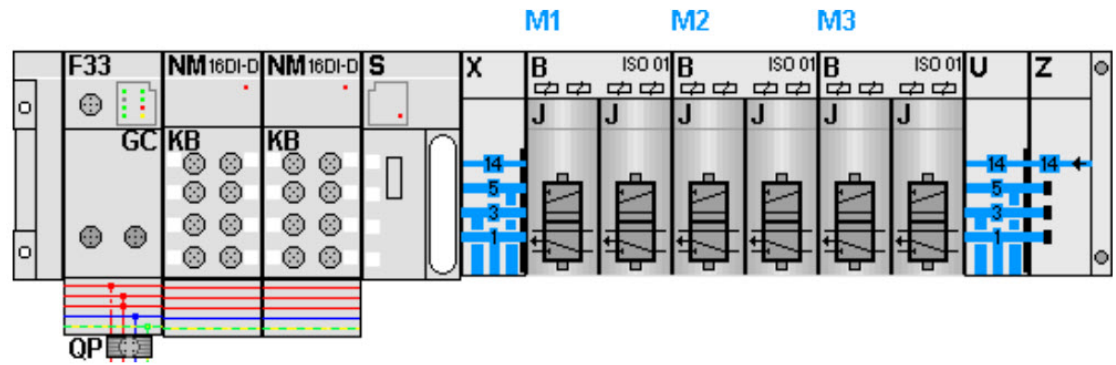

=V2WR1UQ51KF1/11.1 / P2 → 1/2"

=V2WR1UQ51UQ1/1

				Date	9/30/2022	Volvo Trucks North America		Valiant TMS	AIR SUPPLY	Drawing name:		= V2WR1UQ51KF2			
				Ed.	MKLEPADLO					= 2V03&MFS-PNEU		+ V2WR1UQ51			
				Appr		P6700 Underbody Floor Skin - Cell 2V03		Scale 1:1		Document type:	MFS	Project nr:	22-16151	Page	11
Modification	Date	Name	Original			Replacement of	Replaced by								

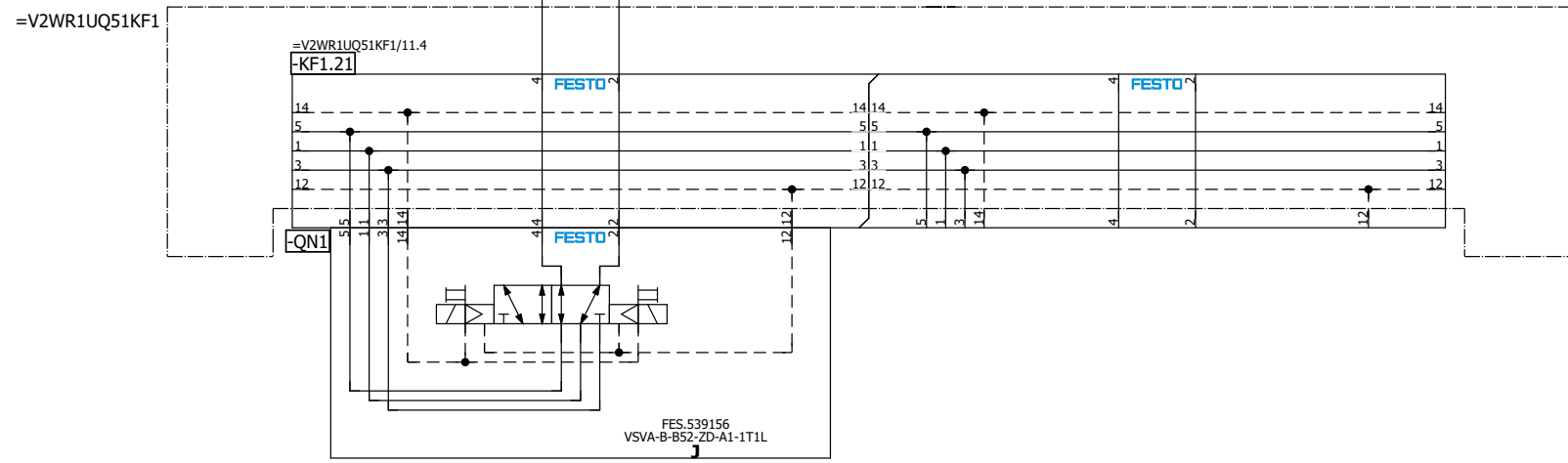
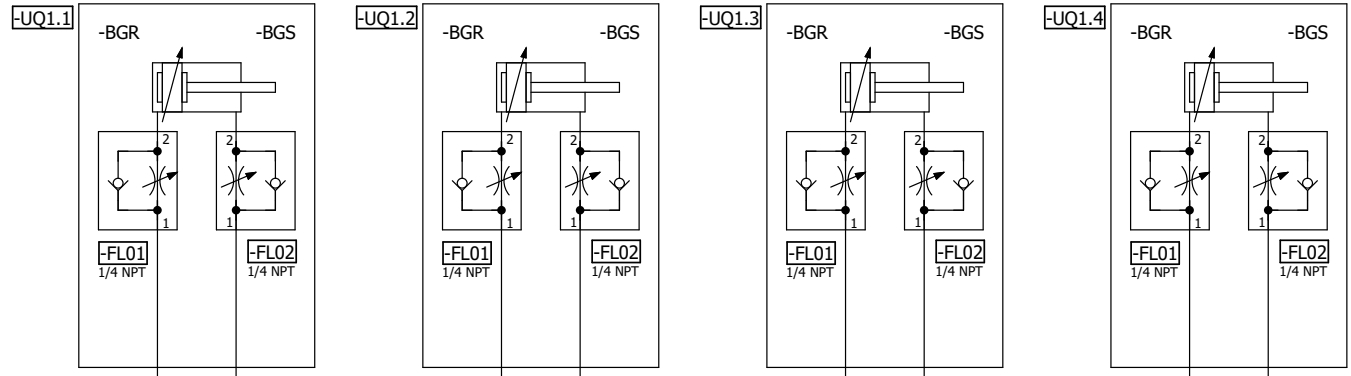

=V2WR1UQ51
-UQ1-QN1.1
Common
Clamps 1 (RST)

=V2WR1UQ51
-UQ1-QN1.2
Common
Clamps 1 (SET)

=V2WR1UQ51KF2/11

=V2WR1UQ51UQ2/1

Date	10/31/2022	Volvo Trucks North America	Valiant TMS	Common Clamps 1	Drawing name:	= 2V03&MFS-PNEU	= V2WR1UQ51UQ1
Ed.	KMAFFRE				Document type:	MFS	+ V2WR1UQ51
Appr		P6700 Underbody Floor Skin - Cell 2V03			Project nr:	22-16151	Page 1
Modification	Date	Name	Original	Replacement of	Replaced by	Scale 1:1	176

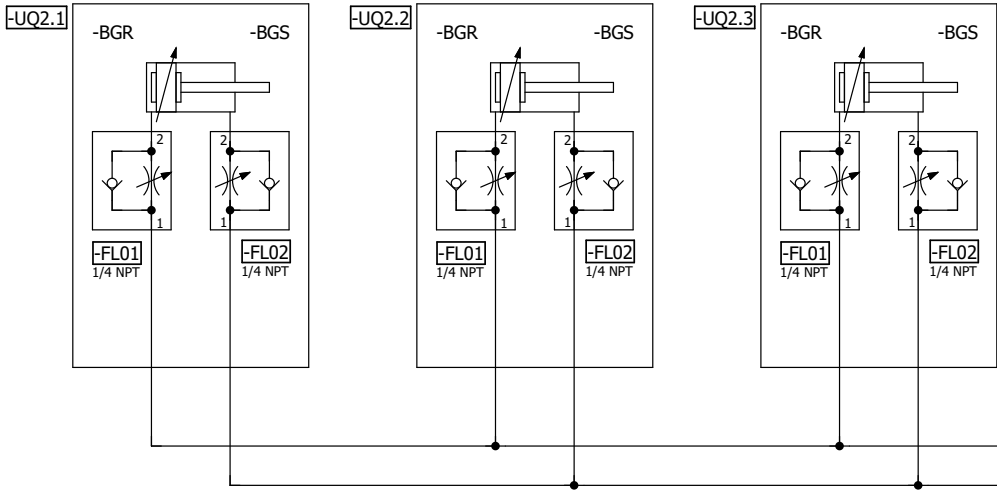

=V2WR1UQ51KF1

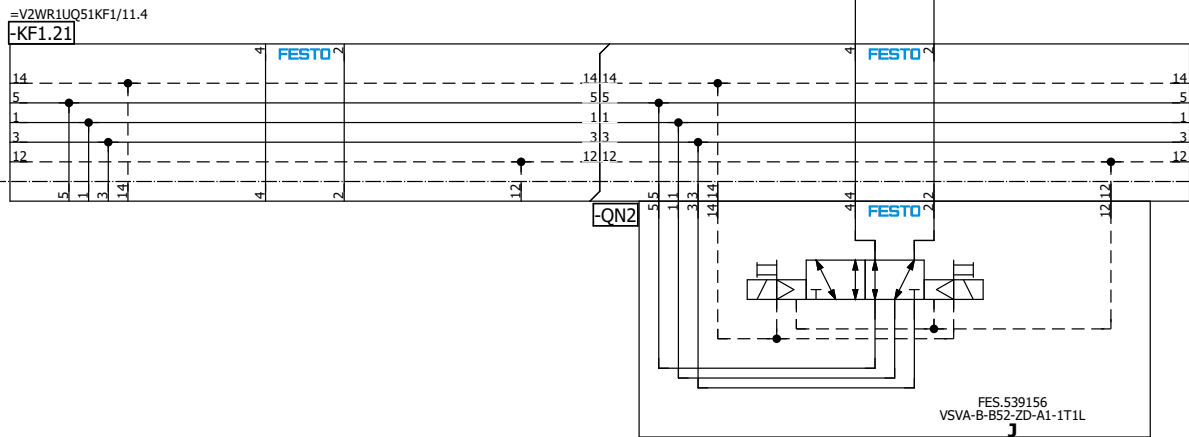

=V2WR1UQ51
-UQ2-QN2.1
Common
Clamps 2 (RST)

=V2WR1UQ51
-UQ2-QN2.2
Common
Clamps 2 (SET)

=V2WR1UQ51UQ3/1

			Date	10/31/2022	Volvo Trucks North America	Valiant TMS	Common Clamps 2	Drawing name:	= 2V03&MFS-PNEU	= V2WR1UQ51UQ2
			Ed.	KMAFFRE	P6700 Underbody Floor Skin - Cell 2V03	Scale 1:1		Document type:	MFS	+ V2WR1UQ51
Modification	Date	Name	Original	Replacement of				Replaced by	Project nr:	22-16151
										176

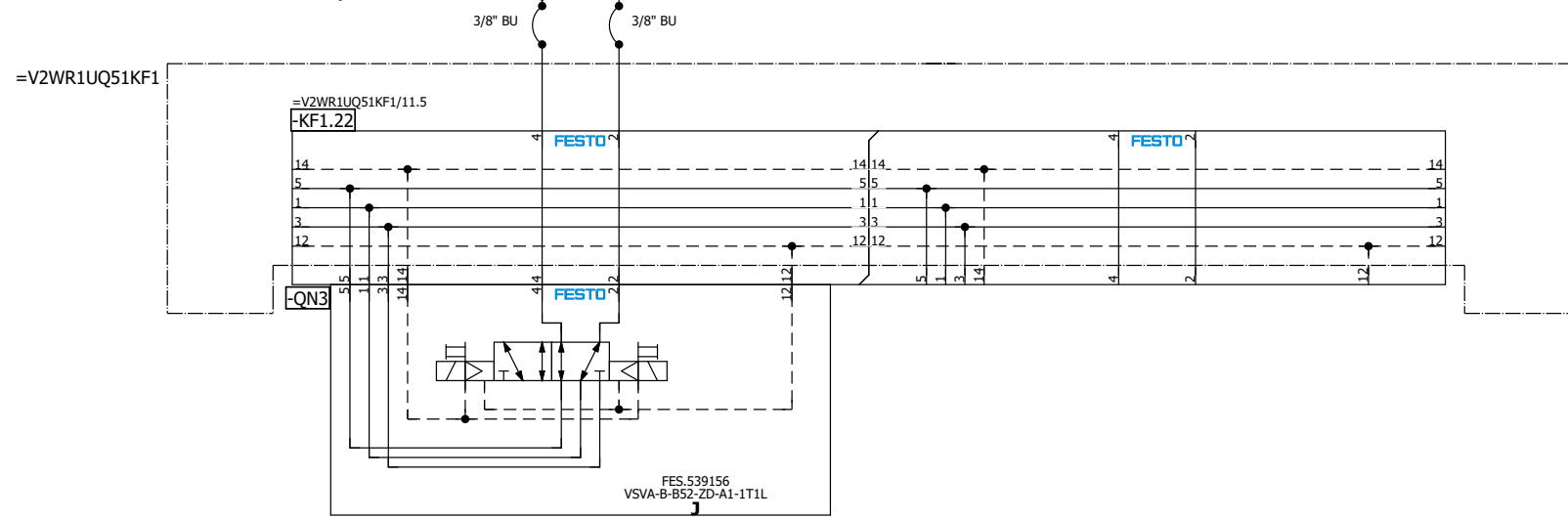
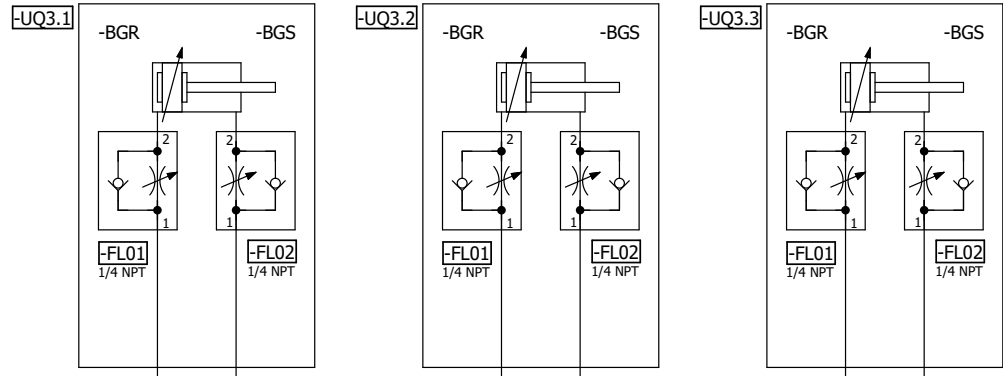

=V2WR1UQ51
-UQ3-QN3.1
L150 Model
Clamps (RST)

=V2WR1UQ51
-UQ3-QN3.2
L150 Model
Clamps (SET)

=V2WR1UQ51UQ2/1 =V2WR1UQ51UQ4/1

Date	10/31/2022	Volvo Trucks North America	Valiant TMS	L150 Model Clamps	Drawing name:	= 2V03&MFS-PNEU	= V2WR1UQ51UQ3
Ed.	KMAFFRE				Document type:	MFS	+ V2WR1UQ51
Appr		P6700 Underbody Floor Skin - Cell 2V03			Project nr:	22-16151	Page
Modification	Date	Name	Original	Replacement of	Replaced by	Scale 1:1	176

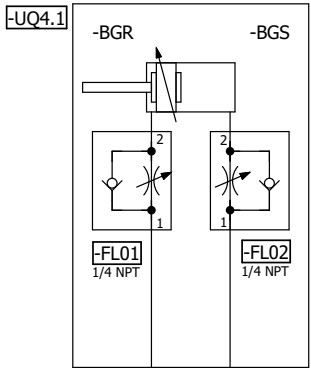

=V2WR1UQ51KF1

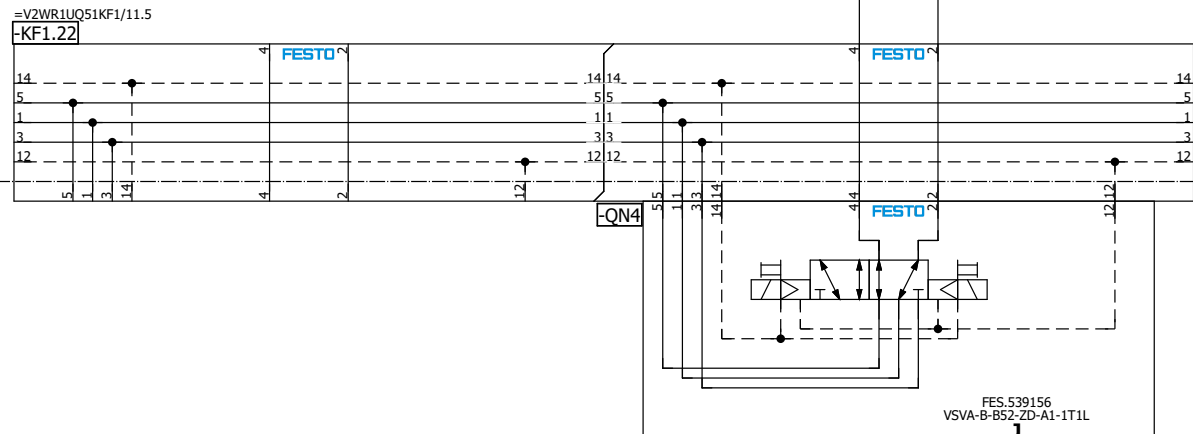

=V2WR1UQ51
-UQ4-QN4.1
Common
Shot Pin (RST)

=V2WR1UQ51
-UQ4-QN4.2
Common
Shot Pin (SET)

FES.539156
VSVA-B-B52-ZD-A1-1T1L

=V2WR1UQ51UQ3/1

=V2WR1UQ51UQ5/1

			Date	10/31/2022	Volvo Trucks North America	Valiant TMS	Common Shot Pin	Drawing name:	= 2V03&MFS-PNEU	= V2WR1UQ51UQ4
			Ed.	KMAFFRE	P6700 Underbody Floor Skin - Cell 2V03	Scale 1:1		Document type:	MFS	+ V2WR1UQ51
Modification	Date	Name	Original	Replacement of				Replaced by	Project nr:	22-16151
										176

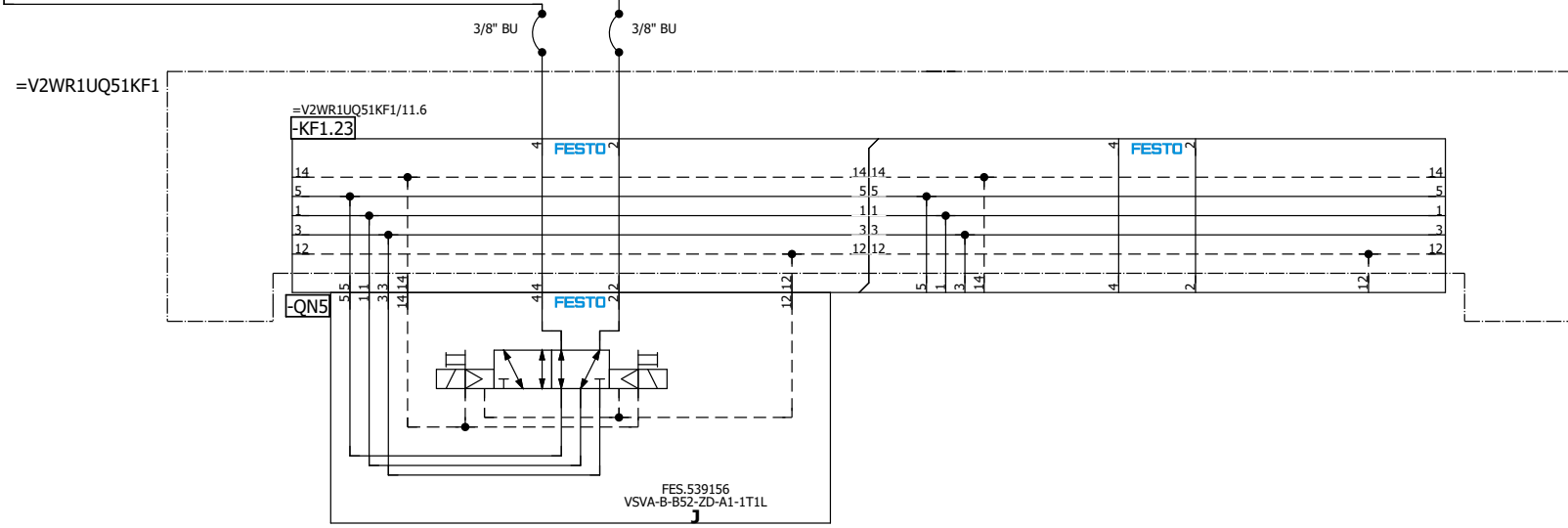
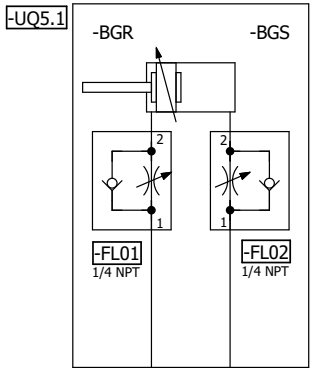

=V2WR1UQ51
-UQ5-QN5.1
L150 Model
Shot Pin (RST)

=V2WR1UQ51
-UQ5-QN5.2
L150 Model
Shot Pin (SET)

=V2WR1UQ51UQ4/1

=V2WR1UQ51UQ6/1

Date	10/31/2022	Volvo Trucks North America	Valiant TMS	L150 Model Shot Pin	Drawing name:	= 2V03&MFS-PNEU	= V2WR1UQ51UQ5
Ed.	KMAFFRE	P6700 Underbody Floor Skin - Cell 2V03	Scale 1:1	Replacement of	Document type:	MFS	+ V2WR1UQ51
Appr					Project nr:	22-16151	Page
Modification	Date	Name	Original	Replaced by			176

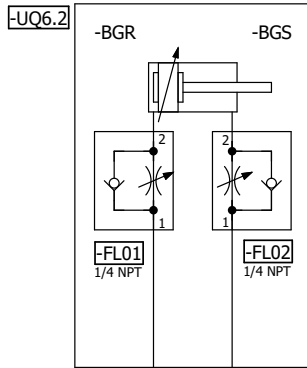
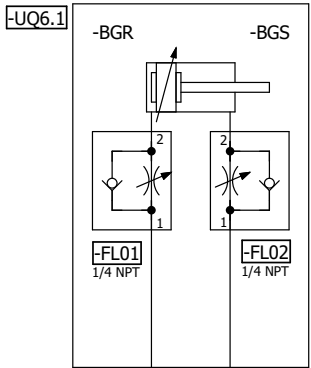

=V2WR1UQ51KF1

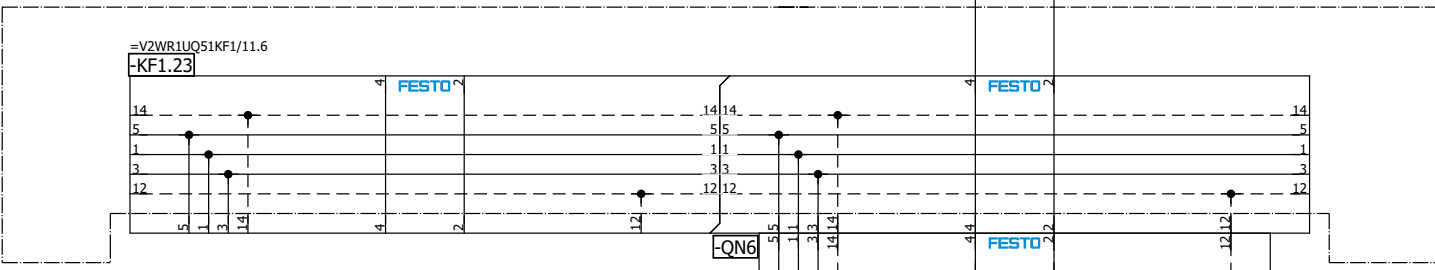

=V2WR1UQ51
-UQ6-QN6.1
L230/290/320
Clamps 1 (RST)

=V2WR1UQ51
-UQ6-QN6.2
L230/290/320
Clamps 1 (SET)

FES.539156
V5VA-B-B52-ZD-A1-1T1L

=V2WR1UQ51UQ5/1

=V2WR1UQ51UQ7/1

Date	10/31/2022	Volvo Trucks North America	Valiant TMS	L230/290/320 Model Clamps 1	Drawing name:	= V2WR1UQ51UQ6		
Ed.	KMAFFRE	P6700 Underbody Floor Skin - Cell 2V03	Scale 1:1		= 2V03&MFS-PNEU	+ V2WR1UQ51		
Appr					Document type:	MFS	Project nr:	22-16151
Modification	Date	Name	Original	Replacement of	Replaced by			176

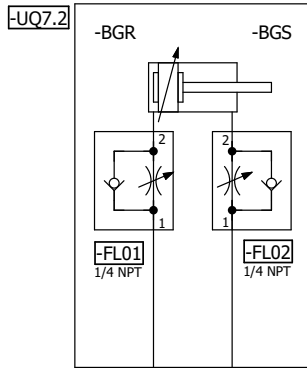
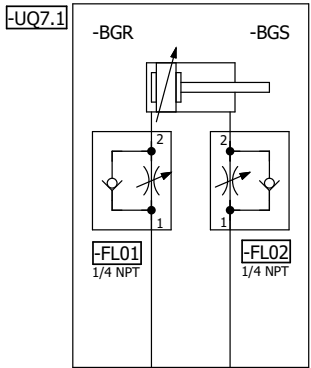

3/8" BU 3/8" BU

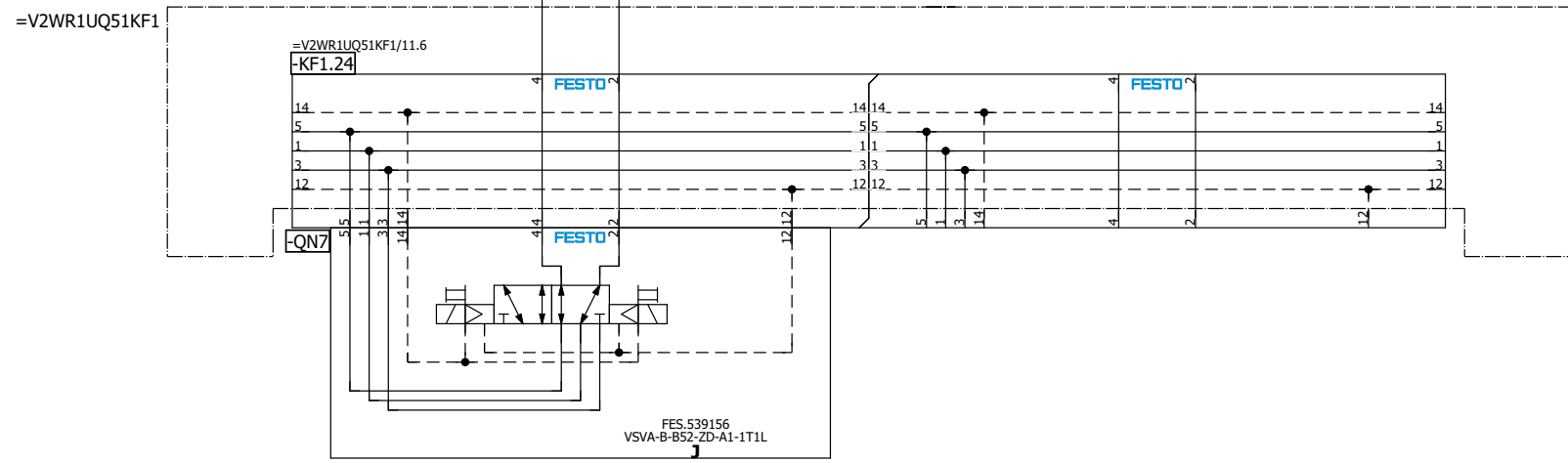

=V2WR1UQ51
-UQ7-QN7.1
L230/290/320
Clamps 2 (RST)

=V2WR1UQ51
-UQ7-QN7.2
L230/290/320
Clamps 2 (SET)

=V2WR1UQ51UQ6/1

=V2WR1UQ51UQ8/1

Date	10/31/2022	Volvo Trucks North America	Valiant TMS	L230/290/320 Model Clamps 2	Drawing name:	= 2V03&MFS-PNEU	= V2WR1UQ51UQ7
Ed.	KMAFFRE	P6700 Underbody Floor Skin - Cell 2V03	Scale 1:1	Replacement of	Document type:	MFS	+ V2WR1UQ51
Appr					Project nr:	22-16151	Page
Modification	Date	Name	Original	Replaced by			176

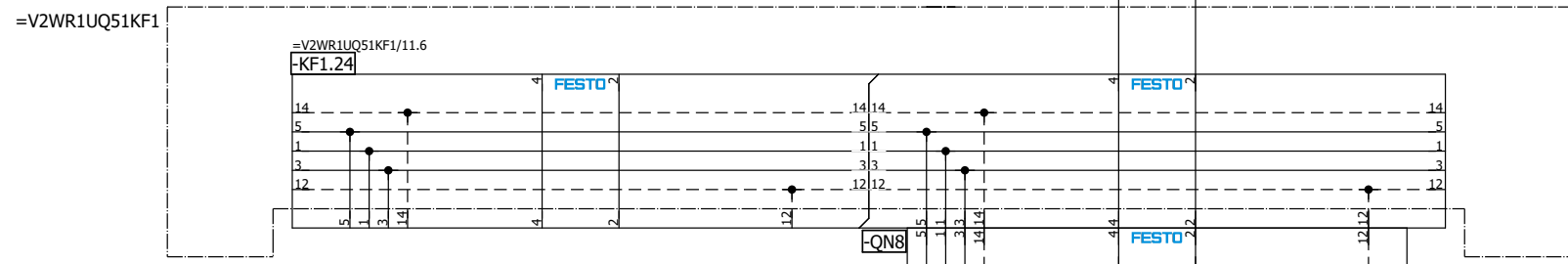
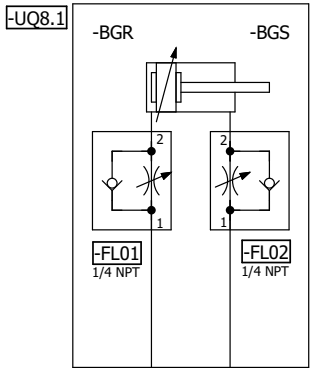

=V2WR1UQ51
-UQ8-QN8.1
L230 Model
Clamp (RST)

=V2WR1UQ51
-UQ8-QN8.2
L230 Model
Clamp (SET)

FES.539156
VSVA-B-B52-ZD-A1-1T1L

=V2WR1UQ51UQ7/1			Date	10/31/2022	Volvo Trucks North America	Valiant TMS	L230 Model Clamp	Drawing name:	= 2V03&MFS-PNEU	= V2WR1UQ51UQ8	
			Ed.	KMAFFRE				Document type:	MFS	+ V2WR1UQ51	
			Appr		P6700 Underbody Floor Skin - Cell 2V03			Project nr:	22-16151	Page	1
Modification	Date	Name	Original		Replacement of	Replaced by	Scale	1:1			176

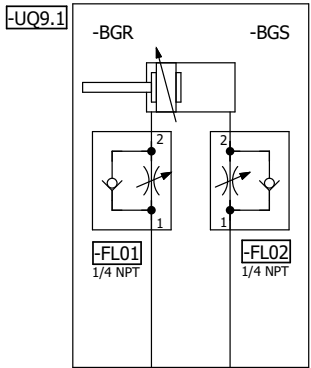

3/8" BU 3/8" BU

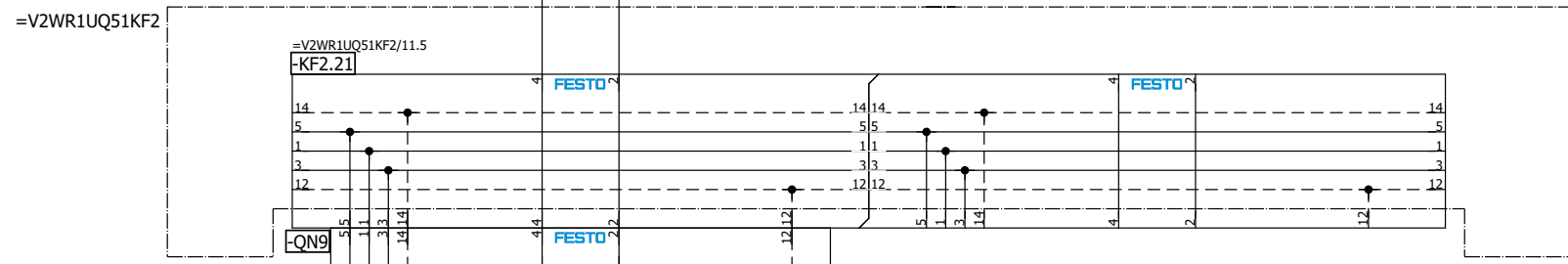

=V2WR1UQ51
-UQ9-QN9.1
L230 Model
Shot Pin (RST)

=V2WR1UQ51
-UQ9-QN9.2
L230 Model
Shot Pin (SET)

FES.539156
V5VA-B-B52-ZD-A1-1T1L

=V2WR1UQ51UQ8/1 =V2WR1UQ51UQ10/1

Date	10/31/2022	Volvo Trucks North America	Valiant TMS	L230 Model Shot Pin	Drawing name:	= 2V03&MFS-PNEU	= V2WR1UQ51UQ9
Ed.	KMAFFRE	P6700 Underbody Floor Skin - Cell 2V03	Scale 1:1	Replacement of	Document type:	MFS	+ V2WR1UQ51
Appr					Project nr:	22-16151	Page
Modification	Date	Name	Original	Replaced by			176

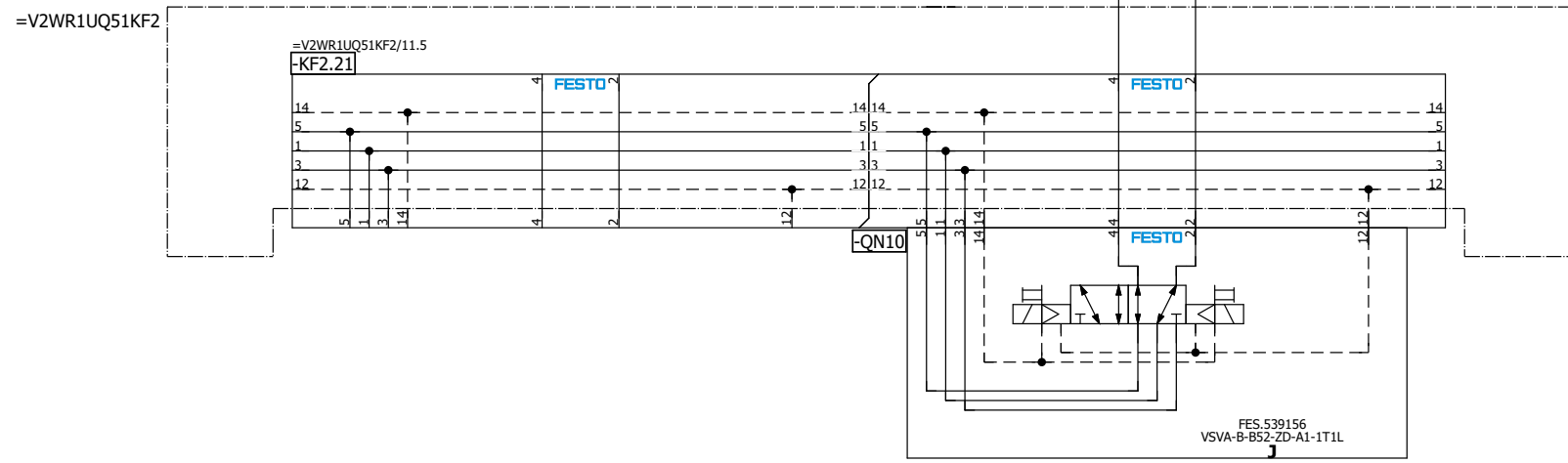
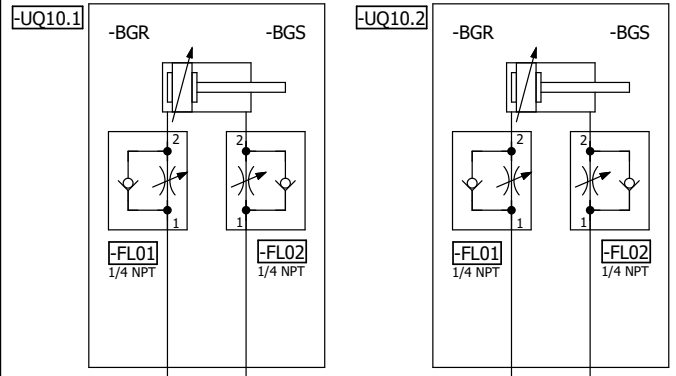

=V2WR1UQ51
-UQ10-QN10.1
L290/320 Model
Clamps (RST)

=V2WR1UQ51
-UQ10-QN10.2
L290/320 Model
Clamps (SET)

=V2WR1UQ51UQ11/1

		Date	10/31/2022	Volvo Trucks North America		Valiant TMS		L290/320 Model Clamps		Drawing name: = 2V03&MFS-PNEU		= V2WR1UQ51UQ10	
		Ed.	KMAFFRE							Document type: MFS		+ V2WR1UQ51	
		Appr		P6700 Underbody Floor Skin - Cell 2V03						Project nr: 22-16151		Page 1	
Modification	Date	Name	Original	Replacement of	Replaced by	Scale 1:1						Page 176	

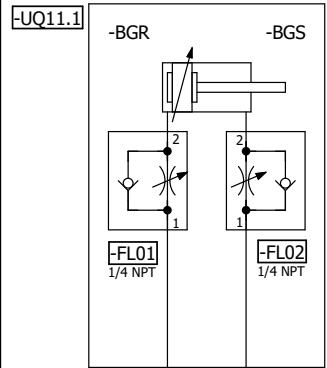

3/8" BU 3/8" BU

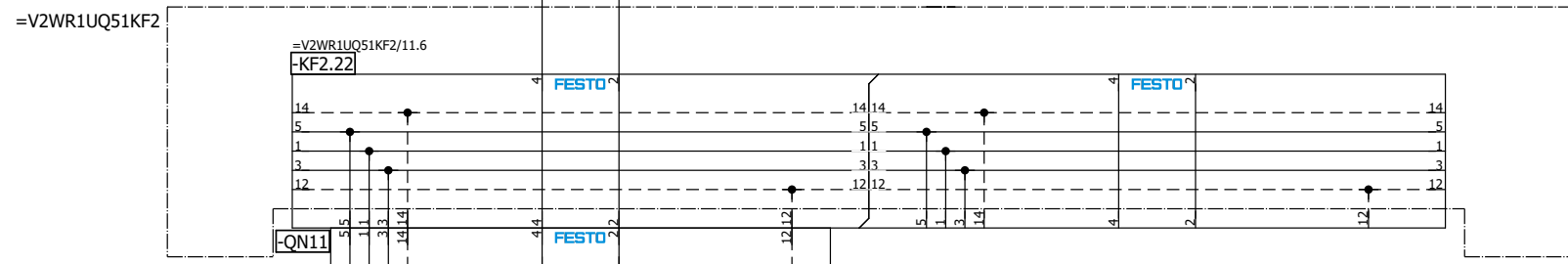

=V2WR1UQ51
-UQ11-QN11.1
L290 Model
Clamp (RST)

=V2WR1UQ51
-UQ11-QN11.2
L290 Model
Clamp (SET)

FES.539156
V5VA-B-B52-ZD-A1-1T1L

=V2WR1UQ51UQ10/1

=V2WR1UQ51UQ12/1

Date	10/31/2022	Volvo Trucks North America	Valiant TMS	L290 Model Clamp	Drawing name:	= 2V03&MFS-PNEU	= V2WR1UQ51UQ11
Ed.	KMAFFRE	P6700 Underbody Floor Skin - Cell 2V03	Scale 1:1		Document type:	MFS	+ V2WR1UQ51
Appr					Project nr:	22-16151	Page
Modification	Date	Name	Original	Replacement of	Replaced by		176

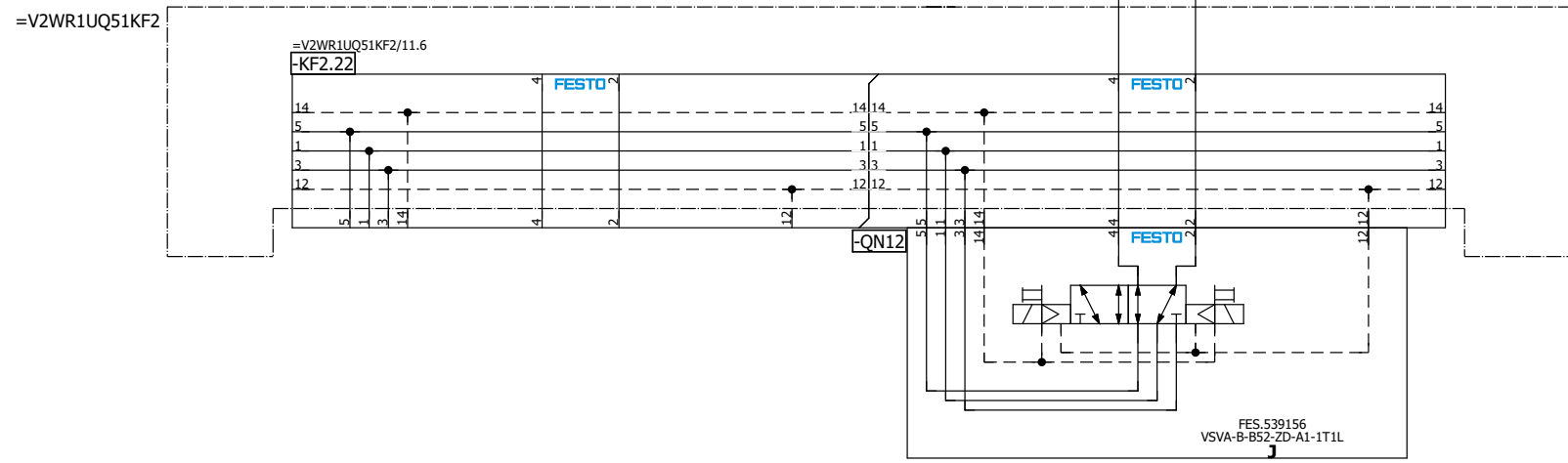
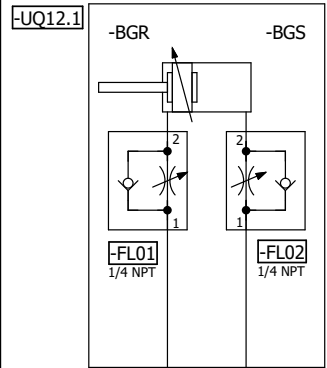

=V2WR1UQ51
-UQ12-QN12.1
L290 Model
Shot Pin (RST)

=V2WR1UQ51
-UQ12-QN12.2
L290 Model
Shot Pin (SET)

=V2WR1UQ51UQ13/1

=V2WR1UQ51UQ11/1

Date	10/31/2022	Volvo Trucks North America	Valiant TMS	L290 Model Shot Pin	Drawing name:	= V2WR1UQ51UQ12			
Ed.	KMAFFRE	P6700 Underbody Floor Skin - Cell 2V03	Scale 1:1		= 2V03&MFS-PNEU	+ V2WR1UQ51			
Appr					Document type:	MFS	Project nr:	22-16151	Page
Modification	Date	Name	Original	Replacement of	Replaced by			Page	176

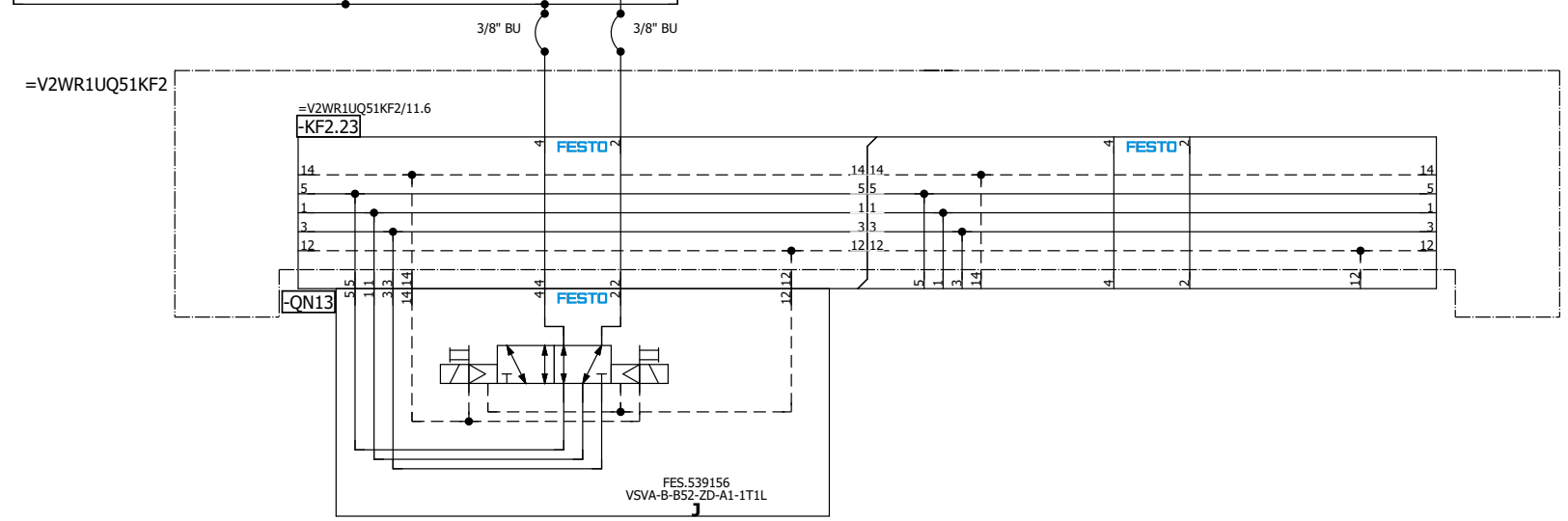
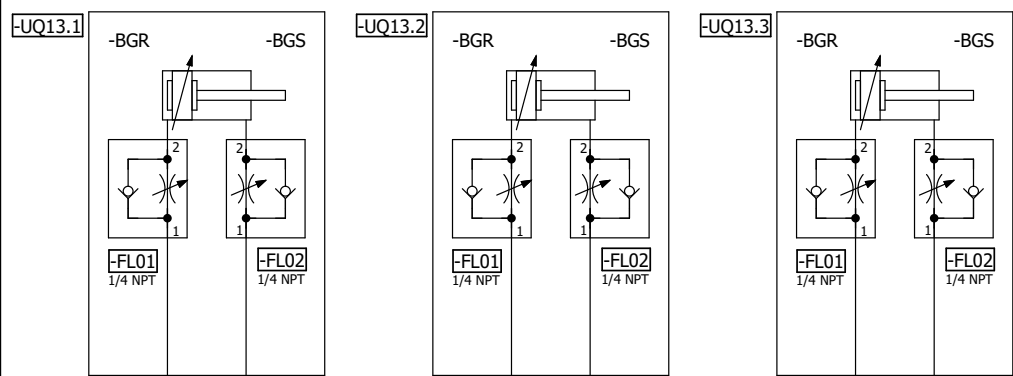

=V2WR1UQ51
-UQ13-QN13.1
L320 Model
Clamps (RST)

=V2WR1UQ51
-UQ13-QN13.2
L320 Model
Clamps (SET)

=V2WR1UQ51UQ12/1

=V2WR1UQ51UQ14/1

Date	10/31/2022	Volvo Trucks North America	Valiant TMS	L320 Model Clamps	Drawing name:	= 2V03&MFS-PNEU	= V2WR1UQ51UQ13
Ed.	KMAFFRE				Document type:	MFS	+ V2WR1UQ51
Appr		P6700 Underbody Floor Skin - Cell 2V03			Project nr:	22-16151	Page 1
Modification	Date	Name	Original	Replacement of	Replaced by	Scale 1:1	176

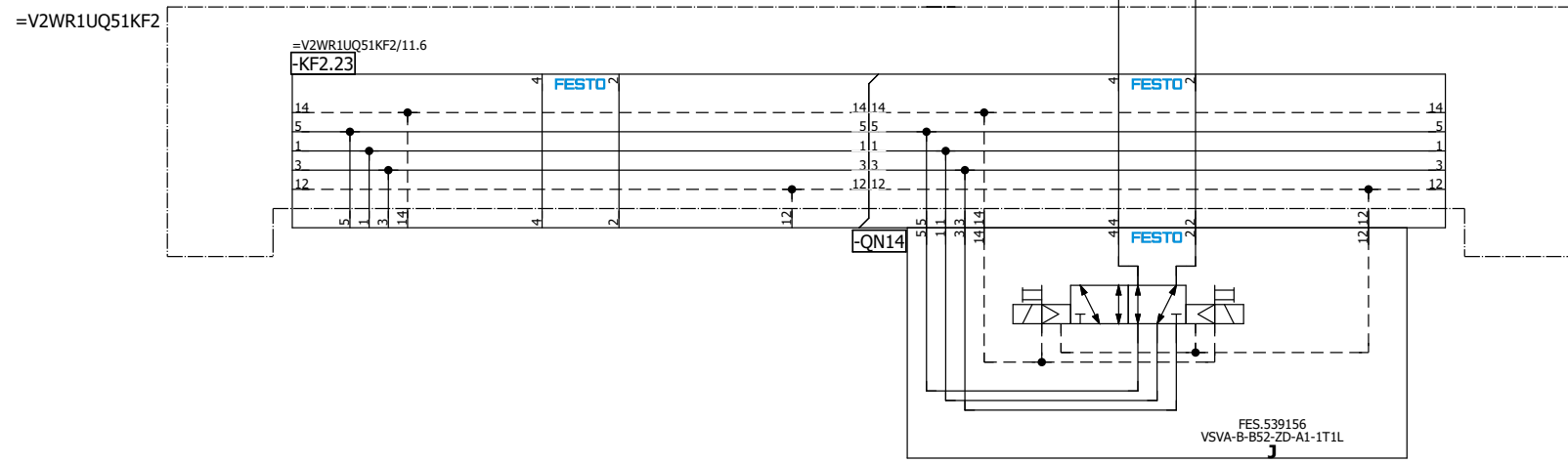
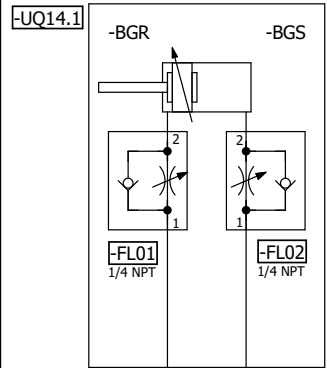

=V2WR1UQ51
-UQ14-QN14.1
L320 Model
Shot Pin (RST)

=V2WR1UQ51
-UQ14-QN14.2
L320 Model
Shot Pin (SET)

=V2WR1UQ51UQ13/1

&MPB+KH0/1

Date	10/31/2022	Volvo Trucks North America	Valiant TMS	L320 Model Shot Pin	Drawing name:	= 2V03&MFS-PNEU	= V2WR1UQ51UQ14
Ed.	KMAFFRE				Document type:	MFS	+ V2WR1UQ51
Appr		P6700 Underbody Floor Skin - Cell 2V03	Scale 1:1		Project nr:	22-16151	Page 1
Modification	Date	Name	Original	Replacement of	Replaced by		176

Parts list

F01_001

Device tag	Quantity	Designation	Type number	Supplier	Part number
=VIUQ51KF1-KF1.0	1	Valve Manifold	51E-F33GCQPNMKBNMKB-S-UL1+GS2GZBA & 45PN-R-ES5MX-3BU-6J		FES.51E-F33GCQPNMKBNMKB-S-UL1+GS2GZBA & 45PN-R-Z-ES5MX-3BU-6J
=VIUQ51KF1-KF1.21	0	Manifold subbase	VABV-S4-IHS-N14-2T2		FES.546213
=VIUQ51KF1-KF1.22	0	Manifold subbase	VABV-S4-IHS-N14-2T2		FES.546213
=VIUQ51KF1-KF1.23	0	Manifold subbase	VABV-S4-IHS-N14-2T2		FES.546213
=VIUQ51KF2-KF2.0	1	Valve Manifold	51E-F33GCQPNMKBNMKB-S-UL1+GS2GZBA & 45PN-R-ES5MX-3BU-6J		FES.51E-F33GCQPNMKBNMKB-S-UL1+GS2GZBA & 45PN-R-Z-ES5MX-3BU-6J
=VIUQ51KF2-KF2.21	0	Manifold subbase	VABV-S4-IHS-N14-2T2		FES.546213
=VIUQ51KF2-KF2.22	0	Manifold subbase	VABV-S4-IHS-N14-2T2		FES.546213
=VIUQ51KF2-KF2.23	0	Manifold subbase	VABV-S4-IHS-N14-2T2		FES.546213
=VIUQ51UQ1-QN1	0	Solenoid valve	VSVA-B-BS2-ZD-A1-1T1L	FES	FES.539156
=VIUQ51UQ1-UQ1.1-FL01	1	One-way flow control valve	GRLA-1/4-QB-3/8-U		FES.534663
=VIUQ51UQ1-UQ1.1-FL02	1	One-way flow control valve	GRLA-1/4-QB-3/8-U		FES.534663
=VIUQ51UQ2-QN2	0	Solenoid valve	VSVA-B-BS2-ZD-A1-1T1L	FES	FES.539156
=VIUQ51UQ2-UQ2.1-FL01	1	One-way flow control valve	GRLA-1/4-QB-3/8-U		FES.534663
=VIUQ51UQ2-UQ2.1-FL02	1	One-way flow control valve	GRLA-1/4-QB-3/8-U		FES.534663
=VIUQ51UQ3-QN3	0	Solenoid valve	VSVA-B-BS2-ZD-A1-1T1L	FES	FES.539156
=VIUQ51UQ3-UQ3.1-FL01	1	One-way flow control valve	GRLA-1/4-QB-3/8-U		FES.534663
=VIUQ51UQ3-UQ3.1-FL02	1	One-way flow control valve	GRLA-1/4-QB-3/8-U		FES.534663
=VIUQ51UQ4-QN4	0	Solenoid valve	VSVA-B-BS2-ZD-A1-1T1L	FES	FES.539156
=VIUQ51UQ4-UQ4.1-FL01	1	One-way flow control valve	GRLA-1/4-QB-3/8-U		FES.534663
=VIUQ51UQ4-UQ4.1-FL02	1	One-way flow control valve	GRLA-1/4-QB-3/8-U		FES.534663
=VIUQ51UQ5-QN5	0	Solenoid valve	VSVA-B-BS2-ZD-A1-1T1L	FES	FES.539156
=VIUQ51UQ5-UQ5.1-FL01	1	One-way flow control valve	GRLA-1/4-QB-3/8-U		FES.534663
=VIUQ51UQ5-UQ5.1-FL02	1	One-way flow control valve	GRLA-1/4-QB-3/8-U		FES.534663
=VIUQ51UQ6-QN6	0	Solenoid valve	VSVA-B-BS2-ZD-A1-1T1L	FES	FES.539156
=VIUQ51UQ6-UQ6.1-FL01	1	One-way flow control valve	GRLA-1/4-QB-3/8-U		FES.534663
=VIUQ51UQ6-UQ6.1-FL02	1	One-way flow control valve	GRLA-1/4-QB-3/8-U		FES.534663
=VIUQ51UQ6-UQ6.2-FL01	1	One-way flow control valve	GRLA-1/4-QB-3/8-U		FES.534663
=VIUQ51UQ6-UQ6.2-FL02	1	One-way flow control valve	GRLA-1/4-QB-3/8-U		FES.534663
=VIUQ51UQ6-UQ6.3-FL01	1	One-way flow control valve	GRLA-1/4-QB-3/8-U		FES.534663
=VIUQ51UQ6-UQ6.3-FL02	1	One-way flow control valve	GRLA-1/4-QB-3/8-U		FES.534663
=VIUQ51UQ6-UQ6.4-FL01	1	One-way flow control valve	GRLA-1/4-QB-3/8-U		FES.534663
=VIUQ51UQ6-UQ6.4-FL02	1	One-way flow control valve	GRLA-1/4-QB-3/8-U		FES.534663
=VIUQ51UQ6-UQ6.5-FL01	1	One-way flow control valve	GRLA-1/4-QB-3/8-U		FES.534663
=VIUQ51UQ6-UQ6.5-FL02	1	One-way flow control valve	GRLA-1/4-QB-3/8-U		FES.534663
=VIUQ51UQ6-UQ6.6-FL01	1	One-way flow control valve	GRLA-1/4-QB-3/8-U		FES.534663
=VIUQ51UQ6-UQ6.6-FL02	1	One-way flow control valve	GRLA-1/4-QB-3/8-U		FES.534663
=VIUQ51UQ7-QN7	0	Solenoid valve	VSVA-B-BS2-ZD-A1-1T1L	FES	FES.539156
=VIUQ51UQ7-UQ7.1-FL01	1	One-way flow control valve	GRLA-1/4-QB-3/8-U		FES.534663
=VIUQ51UQ7-UQ7.1-FL02	1	One-way flow control valve	GRLA-1/4-QB-3/8-U		FES.534663
=VIUQ51UQ7-UQ7.2-FL01	1	One-way flow control valve	GRLA-1/4-QB-3/8-U		FES.534663
=VIUQ51UQ7-UQ7.2-FL02	1	One-way flow control valve	GRLA-1/4-QB-3/8-U		FES.534663
=VIUQ51UQ7-UQ7.3-FL01	1	One-way flow control valve	GRLA-1/4-QB-3/8-U		FES.534663
=VIUQ51UQ7-UQ7.3-FL02	1	One-way flow control valve	GRLA-1/4-QB-3/8-U		FES.534663
=VIUQ51UQ8-QN8	0	Solenoid valve	VSVA-B-BS2-ZD-A1-1T1L	FES	FES.539156
=VIUQ51UQ8-UQ8.1-FL01	1	One-way flow control valve	GRLA-1/4-QB-3/8-U		FES.534663
=VIUQ51UQ8-UQ8.1-FL02	1	One-way flow control valve	GRLA-1/4-QB-3/8-U		FES.534663
=VIUQ51UQ8-UQ8.2-FL01	1	One-way flow control valve	GRLA-1/4-QB-3/8-U		FES.534663
=VIUQ51UQ8-UQ8.2-FL02	1	One-way flow control valve	GRLA-1/4-QB-3/8-U		FES.534663
=VIUQ51UQ8-UQ8.3-FL01	1	One-way flow control valve	GRLA-1/4-QB-3/8-U		FES.534663
=VIUQ51UQ8-UQ8.3-FL02	1	One-way flow control valve	GRLA-1/4-QB-3/8-U		FES.534663
=VIUQ51UQ8-UQ8.4-FL01	1	One-way flow control valve	GRLA-1/4-QB-3/8-U		FES.534663
=VIUQ51UQ8-UQ8.4-FL02	1	One-way flow control valve	GRLA-1/4-QB-3/8-U		FES.534663
=VIUQ51UQ9-QN9	0	Solenoid valve	VSVA-B-BS2-ZD-A1-1T1L	FES	FES.539156
=VIUQ51UQ9-UQ9.1-FL01	1	One-way flow control valve	GRLA-1/4-QB-3/8-U		FES.534663
=VIUQ51UQ9-UQ9.1-FL02	1	One-way flow control valve	GRLA-1/4-QB-3/8-U		FES.534663
=VIUQ51UQ9-UQ9.2-FL01	1	One-way flow control valve	GRLA-1/4-QB-3/8-U		FES.534663

+ .PF1/1

1.a

		Date	9/23/2022	Volvo Trucks North America		Valiant TMS		Material specification		Drawing name: = 2V03&MFS-PNEU		=	
		Ed.	MKLEPADLO									+ VIUQ51	
		Appr		P6700 Underbody Floor Skin - Cell 2V03						Document type: MPB		Project nr: 22-16151	
Modification	Date	Name	Original	Replacement of	Replaced by	Scale 1:1						Page	1
													176

Parts list

F01_001

Device tag	Quantity	Designation	Type number	Supplier	Part number
=V1WR1UQ52UQ7-UQ7.1-FL02	1	One-way flow control valve	GRLA-1/4-QB-3/8-U		FES.534663
=V1WR1UQ52UQ7-UQ7.2-FL01	1	One-way flow control valve	GRLA-1/4-QB-3/8-U		FES.534663
=V1WR1UQ52UQ7-UQ7.2-FL02	1	One-way flow control valve	GRLA-1/4-QB-3/8-U		FES.534663
=V1WR1UQ52UQ7-UQ7.3-FL01	1	One-way flow control valve	GRLA-1/4-QB-3/8-U		FES.534663
=V1WR1UQ52UQ7-UQ7.3-FL02	1	One-way flow control valve	GRLA-1/4-QB-3/8-U		FES.534663
=V1WR1UQ52UQ7-UQ7.4-FL01	1	One-way flow control valve	GRLA-1/4-QB-3/8-U		FES.534663
=V1WR1UQ52UQ7-UQ7.4-FL02	1	One-way flow control valve	GRLA-1/4-QB-3/8-U		FES.534663
=V1WR1UQ52UQ8-QN8	0	Solenoid valve	VSVA-B-P53ED-ZD-A1-1T1L		FES.560727
=V1WR1UQ52UQ8-UQ8.1-FL01	1	One-way flow control valve	GRLA-1/4-QB-3/8-U		FES.534663
=V1WR1UQ52UQ8-UQ8.1-FL02	1	One-way flow control valve	GRLA-1/4-QB-3/8-U		FES.534663
=V1WR1UQ52UQ8-UQ8.2-FL01	1	One-way flow control valve	GRLA-1/4-QB-3/8-U		FES.534663
=V1WR1UQ52UQ8-UQ8.2-FL02	1	One-way flow control valve	GRLA-1/4-QB-3/8-U		FES.534663
=V1WR1UQ52UQ9-QN9	0	Solenoid valve	VSVA-B-P53ED-ZD-A1-1T1L		FES.560727
=V1WR1UQ52UQ9-UQ9.1-FL01	1	One-way flow control valve	GRLA-1/4-QB-3/8-U		FES.534663
=V1WR1UQ52UQ9-UQ9.1-FL02	1	One-way flow control valve	GRLA-1/4-QB-3/8-U		FES.534663
=V1WR1UQ52UQ9-UQ9.2-FL01	1	One-way flow control valve	GRLA-1/4-QB-3/8-U		FES.534663
=V1WR1UQ52UQ9-UQ9.2-FL02	1	One-way flow control valve	GRLA-1/4-QB-3/8-U		FES.534663
=V1WR1UQ52UQ10-QN10	0	Solenoid valve	VSVA-B-P53ED-ZD-A1-1T1L		FES.560727
=V1WR1UQ52UQ10-UQ10.1-FL01	1	One-way flow control valve	GRLA-1/4-QB-3/8-U		FES.534663
=V1WR1UQ52UQ10-UQ10.1-FL02	1	One-way flow control valve	GRLA-1/4-QB-3/8-U		FES.534663
=V1WR1UQ52UQ10-UQ10.2-FL01	1	One-way flow control valve	GRLA-1/4-QB-3/8-U		FES.534663
=V1WR1UQ52UQ10-UQ10.2-FL02	1	One-way flow control valve	GRLA-1/4-QB-3/8-U		FES.534663
=V1WR1UQ52UQ11-QN11	0	Solenoid valve	VSVA-B-P53ED-ZD-A1-1T1L		FES.560727
=V1WR1UQ52UQ11-UQ11.1-FL01	1	One-way flow control valve	GRLA-1/4-QB-3/8-U		FES.534663
=V1WR1UQ52UQ11-UQ11.1-FL02	1	One-way flow control valve	GRLA-1/4-QB-3/8-U		FES.534663
=V1WR1UQ52UQ11-UQ11.2-FL01	1	One-way flow control valve	GRLA-1/4-QB-3/8-U		FES.534663
=V1WR1UQ52UQ11-UQ11.2-FL02	1	One-way flow control valve	GRLA-1/4-QB-3/8-U		FES.534663
=V1WR1UQ52UQ11-UQ11.3-FL01	1	One-way flow control valve	GRLA-1/4-QB-3/8-U		FES.534663
=V1WR1UQ52UQ11-UQ11.3-FL02	1	One-way flow control valve	GRLA-1/4-QB-3/8-U		FES.534663
=V1WR1UQ52UQ12-QN12	0	Solenoid valve	VSVA-B-P53ED-ZD-A1-1T1L		FES.560727
=V1WR1UQ52UQ12-UQ12.1-FL01	1	One-way flow control valve	GRLA-1/4-QB-3/8-U		FES.534663
=V1WR1UQ52UQ12-UQ12.1-FL02	1	One-way flow control valve	GRLA-1/4-QB-3/8-U		FES.534663
=V1WR1UQ52UQ13-QN13	0	Solenoid valve	VSVA-B-P53ED-ZD-A1-1T1L		FES.560727
=V1WR1UQ52UQ13-UQ13.1-FL01	1	One-way flow control valve	GRLA-1/4-QB-3/8-U		FES.534663
=V1WR1UQ52UQ13-UQ13.1-FL02	1	One-way flow control valve	GRLA-1/4-QB-3/8-U		FES.534663
=V1WR1UQ52UQ13-UQ13.2-FL01	1	One-way flow control valve	GRLA-1/4-QB-3/8-U		FES.534663
=V1WR1UQ52UQ13-UQ13.2-FL02	1	One-way flow control valve	GRLA-1/4-QB-3/8-U		FES.534663
=V1WR1UQ52UQ14-QN14	0	Solenoid valve	VSVA-B-P53ED-ZD-A1-1T1L		FES.560727
=V1WR1UQ52UQ14-UQ14.1-FL01	1	One-way flow control valve	GRLA-1/4-QB-3/8-U		FES.534663
=V1WR1UQ52UQ14-UQ14.1-FL02	1	One-way flow control valve	GRLA-1/4-QB-3/8-U		FES.534663
=V1WR1UQ52UQ14-UQ14.2-FL01	1	One-way flow control valve	GRLA-1/4-QB-3/8-U		FES.534663
=V1WR1UQ52UQ14-UQ14.2-FL02	1	One-way flow control valve	GRLA-1/4-QB-3/8-U		FES.534663
=V1WR1UQ52UQ15-QN15	0	Solenoid valve	VSVA-B-P53ED-ZD-A1-1T1L		FES.560727
=V1WR1UQ52UQ15-UQ15.1-FL01	1	One-way flow control valve	GRLA-1/4-QB-3/8-U		FES.534663
=V1WR1UQ52UQ15-UQ15.1-FL02	1	One-way flow control valve	GRLA-1/4-QB-3/8-U		FES.534663
=V1WR1UQ52UQ16-QN16	1	Solenoid valve	VSVA-B-P53E-ZD-A1-1T1L		FES.539161
=V1WR1UQ52UQ16-QN100	1	3/8" DUAL PO CHECK VALVE, IN-LINE W/MANUAL TRAPPED AIR RELIEF	Z768D3904	ROSS CONTROLS	Z768D3904
=V1WR1UQ52UQ16-UQ16.1-FL01	1	One-way flow control valve	GRLA-1/4-QB-3/8-U		FES.534663
=V1WR1UQ52UQ16-UQ16.1-FL02	1	One-way flow control valve	GRLA-1/4-QB-3/8-U		FES.534663
=V1WR1UQ52UQ17-QN17	0	Solenoid valve	VSVA-B-P53ED-ZD-A1-1T1L		FES.560727
=V1WR1UQ52UQ17-UQ17.1-FL01	1	One-way flow control valve	GRLA-1/4-QB-3/8-U		FES.534663
=V1WR1UQ52UQ17-UQ17.1-FL02	1	One-way flow control valve	GRLA-1/4-QB-3/8-U		FES.534663
=V1WR1UQ52UQ17-UQ17.2-FL01	1	One-way flow control valve	GRLA-1/4-QB-3/8-U		FES.534663
=V1WR1UQ52UQ17-UQ17.2-FL02	1	One-way flow control valve	GRLA-1/4-QB-3/8-U		FES.534663
=V1WR1UQ52UQ18-QN18	0	Solenoid valve	VSVA-B-P53ED-ZD-A1-1T1L		FES.560727
=V1WR1UQ52UQ18-UQ18.1-FL01	1	One-way flow control valve	GRLA-1/4-QB-3/8-U		FES.534663

1

1.b

		Date	11/16/2022	Volvo Trucks North America		Valiant TMS		Material specification		Drawing name: = 2V03&MFS-PNEU		=	
		Ed.	KMAFFRE	P6700 Underbody Floor Skin - Cell 2V03		Scale 1:1				Document type:		Project nr:	
		Appr								MPB		22-16151	
Modification	Date	Name	Original	Replacement of	Replaced by							Page	
												176	

1	2	3	4	5	6	7	8	9	10	
LATEST REVISION										
REV.	DATE	SIGN.	DRAWING NR:							SHEET NR:
2	2022-10-31	KMAFFRE	&MFS=KH0+KH0							1
2	2022-10-31	KMAFFRE	&MFS=V1PF1+KH1							1
2	2022-10-31	KMAFFRE	&MFS=V1PF1KF1+V1PF1							5,11
2	2022-10-31	KMAFFRE	&MFS=V1PF1UQ1+V1PF1							1
2	2022-10-31	KMAFFRE	&MFS=V1PF1UQ2+V1PF1							1
2	2022-11-11	KMAFFRE	&MFS=V1AR11UQ41KF1+V1AR11UQ41							11
2	2022-11-04	KMAFFRE	&MFS=V1AR11UQ41UQ1+V1AR11UQ41							1
2	2022-11-04	KMAFFRE	&MFS=V1AR11UQ41UQ2+V1AR11UQ41							1
2	2022-11-04	KMAFFRE	&MFS=V1AR11UQ41UQ3+V1AR11UQ41							1
2	2022-11-04	KMAFFRE	&MFS=V1AR11UQ41UQ4+V1AR11UQ41							1
2	2022-11-04	KMAFFRE	&MFS=V1AR11UQ41UQ5+V1AR11UQ41							1
2	2022-11-04	KMAFFRE	&MFS=V1AR11UQ41UQ6+V1AR11UQ41							1
2	2022-11-04	KMAFFRE	&MFS=V1AR11UQ41UQ7+V1AR11UQ41							1
2	2022-11-04	KMAFFRE	&MFS=V1AR11UQ41UQ8+V1AR11UQ41							1
2	2022-11-11	KMAFFRE	&MFS=V1AR12UQ41KF1+V1AR12UQ41							11
2	2022-11-11	KMAFFRE	&MFS=V1AR12UQ41KF2+V1AR12UQ41							11
2	2022-11-04	KMAFFRE	&MFS=V1AR12UQ41UQ1+V1AR12UQ41							1
2	2022-11-04	KMAFFRE	&MFS=V1AR12UQ41UQ2+V1AR12UQ41							1
2	2022-11-04	KMAFFRE	&MFS=V1AR12UQ41UQ3+V1AR12UQ41							1
2	2022-11-04	KMAFFRE	&MFS=V1AR12UQ41UQ4+V1AR12UQ41							1
2	2022-11-04	KMAFFRE	&MFS=V1AR12UQ41UQ5+V1AR12UQ41							1
2	2022-11-04	KMAFFRE	&MFS=V1AR12UQ41UQ6+V1AR12UQ41							1
2	2022-11-04	KMAFFRE	&MFS=V1AR12UQ41UQ7+V1AR12UQ41							1
2	2022-11-04	KMAFFRE	&MFS=V1AR12UQ41UQ8+V1AR12UQ41							1
2	2022-11-04	KMAFFRE	&MFS=V1AR12UQ41UQ9+V1AR12UQ41							1
2	2022-11-04	KMAFFRE	&MFS=V1AR12UQ41UQ10+V1AR12UQ41							1
2	2022-11-04	KMAFFRE	&MFS=V1AR12UQ41UQ11+V1AR12UQ41							1
2	2022-11-04	KMAFFRE	&MFS=V1AR12UQ41UQ12+V1AR12UQ41							1
2	2022-11-11	KMAFFRE	&MFS=V1AR12UQ42KF1+V1AR12UQ42							11
2	2022-11-04	KMAFFRE	&MFS=V1AR12UQ42UQ1+V1AR12UQ42							1
2	2022-11-04	KMAFFRE	&MFS=V1AR12UQ42UQ2+V1AR12UQ42							1
2	2022-11-04	KMAFFRE	&MFS=V1AR12UQ42UQ3+V1AR12UQ42							1

2										4	
			Date	11/11/2022	Volvo Trucks North America		Valiant TMS	Amendment page	Drawing name:	= 2V03&MFS-PNEU	=
			Ed.	KMAFFRE							+
			Appr		P6700 Underbody Floor Skin - Cell 2V03				Document type:	Project nr:	Page
Modification	Date	Name	Original		Replacement of	Replaced by	Scale 1:10		MAZ	22-16151	3
										176	

