

# Valiant TMS



Company / customer Volvo Trucks NA  
 Project description P6700 Underbody Mainline - Cell 2V04  
 drawing number 22-16151  
 Commission Volvo Trucks North America



Manufacturer (company) Valiant TMS  
 Project name =2V04&MFS-PNEU  
 Type P6700 Underbody Mainline - Cell 2V04

Created on 6/29/2022  
 Edit date 12/21/2022 by (short name) MKLEPADLO  
 Number of pages 227

Date	12/2/2022	Volvo Trucks North America	 Valiant TMS	Title page / cover sheet	Drawing name: =2V04&MFS-PNEU		=
Ed.	MKLEPADLO	P6700 Underbody Mainline - Cell 2V04			Document type: MAA		Project nr: 22-16151
Modification	Date	Name	Original	Replacement of	Replaced by	Scale 1:1	Page 1
							227

# Table of contents

Column X: An automatically generated page was edited

F06\_001

Page	Page description	supplementary page field	Date	Edited by	X
&MAA/1	Title page / cover sheet		12/2/2022	MKLEPADLO	
&MAB/1	Table of contents : &MAA/1 - &MFS=V1AR11UQ41UQ17+V1AR11UQ41/1		12/21/2022	MKLEPADLO	
&MAB/2	Table of contents : &MFS=V1AR11UQ41UQ18+V1AR11UQ41/1 - &MFS=V1AR13UQ41UQ10+V1AR13UQ41/1		12/21/2022	MKLEPADLO	
&MAB/3	Table of contents : &MFS=V1AR14UQ41KF1+V1AR14UQ41/1 - &MFS=V1GL11UQ51UQ5+V1GL11UQ51/1		12/21/2022	MKLEPADLO	
&MAB/4	Table of contents : &MFS=V1GL11UQ51UQ6+V1GL11UQ51/1 - &MFS=V1UQ51UQ4+V1UQ51/1		12/21/2022	MKLEPADLO	
&MAB/5	Table of contents : &MFS=V1UQ51UQ5+V1UQ51/1 - &MFS=V1UQ53UQ1+V1UQ53/1		12/21/2022	MKLEPADLO	
&MAB/6	Table of contents : &MFS=V1UQ53UQ2+V1UQ53/1 - &MFS=V1WR1UQ51UQ5+V1WR1UQ51/1		12/21/2022	MKLEPADLO	
&MAB/7	Table of contents : &MFS=V1WR1UQ51UQ6+V1WR1UQ51/1 - &MAZ/5		12/21/2022	MKLEPADLO	
&MFS=KH0+KH0/1	Incoming air supply		12/21/2022	MKLEPADLO	
&MFS=V1AR11UQ41KF1+V1AR11UQ41/1	AIR SUPPLY GRIPPER		12/21/2022	MKLEPADLO	
&MFS=V1AR11UQ41KF1+V1AR11UQ41/1	AIR SUPPLY		12/21/2022	MKLEPADLO	
&MFS=V1AR11UQ41KF1+V1AR11UQ41/1	AIR SUPPLY		12/21/2022	MKLEPADLO	
&MFS=V1AR11UQ41KF2+V1AR11UQ41/1	AIR SUPPLY		12/21/2022	MKLEPADLO	
&MFS=V1AR11UQ41KF2+V1AR11UQ41/1	AIR SUPPLY		12/21/2022	MKLEPADLO	
&MFS=V1AR11UQ41KF3+V1AR11UQ41/1	AIR SUPPLY		12/21/2022	MKLEPADLO	
&MFS=V1AR11UQ41KF3+V1AR11UQ41/1	AIR SUPPLY		12/21/2022	MKLEPADLO	
&MFS=V1AR11UQ41UQ1+V1AR11UQ41/1	Common Shot Pin		12/21/2022	MKLEPADLO	
&MFS=V1AR11UQ41UQ2+V1AR11UQ41/1	L150/230 Model Shot Pin		12/21/2022	MKLEPADLO	
&MFS=V1AR11UQ41UQ3+V1AR11UQ41/1	L150 Model Shot Pins		12/21/2022	MKLEPADLO	
&MFS=V1AR11UQ41UQ4+V1AR11UQ41/1	Common Clamps 1		12/21/2022	MKLEPADLO	
&MFS=V1AR11UQ41UQ5+V1AR11UQ41/1	Common Clamps 2		12/21/2022	MKLEPADLO	
&MFS=V1AR11UQ41UQ6+V1AR11UQ41/1	Common Clamps 3		12/21/2022	MKLEPADLO	
&MFS=V1AR11UQ41UQ7+V1AR11UQ41/1	Common Vacuums		12/21/2022	MKLEPADLO	
&MFS=V1AR11UQ41UQ8+V1AR11UQ41/1	Common Clamps 4		12/21/2022	MKLEPADLO	
&MFS=V1AR11UQ41UQ9+V1AR11UQ41/1	L230/290/320 Model Clamps		12/21/2022	MKLEPADLO	
&MFS=V1AR11UQ41UQ10+V1AR11UQ41/1	L230/320 Model Clamps		12/21/2022	MKLEPADLO	
&MFS=V1AR11UQ41UQ11+V1AR11UQ41/1	L230 Model Clamp 1		12/21/2022	MKLEPADLO	
&MFS=V1AR11UQ41UQ12+V1AR11UQ41/1	L230 Model Vacuums		12/21/2022	MKLEPADLO	
&MFS=V1AR11UQ41UQ13+V1AR11UQ41/1	L230/290/320 Model Vacuum		12/21/2022	MKLEPADLO	
&MFS=V1AR11UQ41UQ14+V1AR11UQ41/1	L230 Model Clamps 2		12/21/2022	MKLEPADLO	
&MFS=V1AR11UQ41UQ15+V1AR11UQ41/1	L290 Model Clamps 1		12/21/2022	MKLEPADLO	
&MFS=V1AR11UQ41UQ16+V1AR11UQ41/1	L290/320 Model Clamps		12/21/2022	MKLEPADLO	
&MFS=V1AR11UQ41UQ17+V1AR11UQ41/1	L290 Model Clamp 2		12/21/2022	MKLEPADLO	

&MAA/1

2

Date	12/21/2022	Volvo Trucks North America	Valiant TMS	Table of contents : &MAA/1 - &MFS=V1AR11UQ41UQ17+V1AR11UQ41/1	Drawing name: =2V04&MFS-PNEU	=	
Ed.	MKLEPADLO	P6700 Underbody Mainline - Cell 2V04		Scale 1:1	Document type: MAB	Project nr: 22-16151	+
Appr					Page	1	
Modification	Date	Name	Original	Replacement of	Replaced by		227



# Table of contents

Column X: An automatically generated page was edited

F06\_001

Page	Page description	supplementary page field	Date	Edited by	X
&MFS=V1AR14UQ41KF1+V1AR14UQ41/	AIR SUPPLY GRIPPER		12/21/2022	MKLEPADLO	
&MFS=V1AR14UQ41KF1+V1AR14UQ41/	AIR SUPPLY		12/21/2022	MKLEPADLO	
&MFS=V1AR14UQ41KF1+V1AR14UQ41/	AIR SUPPLY		12/21/2022	MKLEPADLO	
&MFS=V1AR14UQ41UQ1+V1AR14UQ41/	Common Shot Pins		12/21/2022	MKLEPADLO	
&MFS=V1AR14UQ41UQ2+V1AR14UQ41/	Common Vacuums		12/21/2022	MKLEPADLO	
&MFS=V1AR14UQ41UQ3+V1AR14UQ41/	L230/320 Model Vacuums		12/21/2022	MKLEPADLO	
&MFS=V1AR14UQ41UQ4+V1AR14UQ41/	L290 Model Vacuums		12/21/2022	MKLEPADLO	
&MFS=V1AR14UQ41UQ5+V1AR14UQ41/	L320 Model Vacuums		12/21/2022	MKLEPADLO	
&MFS=V1AR14UQ41UQ6+V1AR14UQ41/	Common Clamps		12/21/2022	MKLEPADLO	
&MFS=V1AR14UQ41UQ7+V1AR14UQ41/	L150 Model Clamps		12/21/2022	MKLEPADLO	
&MFS=V1AR14UQ41UQ8+V1AR14UQ41/	L230 Model Clamps		12/21/2022	MKLEPADLO	
&MFS=V1AR14UQ41UQ9+V1AR14UQ41/	L290 Model Clamps		12/21/2022	MKLEPADLO	
&MFS=V1AR14UQ41UQ10+V1AR14UQ41/	L320 Model Clamps		12/21/2022	MKLEPADLO	
&MFS=V1AR15UQ41KF1+V1AR15UQ41/	AIR SUPPLY GRIPPER		12/21/2022	MKLEPADLO	
&MFS=V1AR15UQ41KF1+V1AR15UQ41/	AIR SUPPLY		12/21/2022	MKLEPADLO	
&MFS=V1AR15UQ41KF1+V1AR15UQ41/	AIR SUPPLY		12/21/2022	MKLEPADLO	
&MFS=V1AR15UQ41UQ1+V1AR15UQ41/	Common Vacuums		12/21/2022	MKLEPADLO	
&MFS=V1AR15UQ41UQ2+V1AR15UQ41/	L230/320 Model Vacuums		12/21/2022	MKLEPADLO	
&MFS=V1AR15UQ41UQ3+V1AR15UQ41/	L290 Model Vacuums		12/21/2022	MKLEPADLO	
&MFS=V1AR15UQ41UQ4+V1AR15UQ41/	L320 Model Vacuums		12/21/2022	MKLEPADLO	
&MFS=V1AR15UQ41UQ5+V1AR15UQ41/	Common Clamps		12/21/2022	MKLEPADLO	
&MFS=V1AR15UQ41UQ6+V1AR15UQ41/	L150 Model Clamps		12/21/2022	MKLEPADLO	
&MFS=V1AR15UQ41UQ7+V1AR15UQ41/	L230 Model Clamps		12/21/2022	MKLEPADLO	
&MFS=V1AR15UQ41UQ8+V1AR15UQ41/	L290 Model Clamps		12/21/2022	MKLEPADLO	
&MFS=V1AR15UQ41UQ9+V1AR15UQ41/	L320 Model Clamps		12/21/2022	MKLEPADLO	
&MFS=V1AR15UQ41UQ10+V1AR15UQ41/	Spare		12/21/2022	MKLEPADLO	
&MFS=V1GL11+KH1/1	Incoming air supply (Fixture)		12/21/2022	MKLEPADLO	
&MFS=V1GL11UQ51KF2+V1GL11UQ51/	AIR SUPPLY CONFIGURATION		12/21/2022	MKLEPADLO	
&MFS=V1GL11UQ51KF2+V1GL11UQ51/	AIR SUPPLY		12/20/2022	MKLEPADLO	
&MFS=V1GL11UQ51UQ2+V1GL11UQ51/	Pallet Stop Station #2 Mid-Stop #1		12/21/2022	MKLEPADLO	
&MFS=V1GL11UQ51UQ3+V1GL11UQ51/	Pallet Stop Station #3 Mid-Stop #2		12/21/2022	MKLEPADLO	
&MFS=V1GL11UQ51UQ4+V1GL11UQ51/	Pallet Stop Station #4 Pre-Unload		12/21/2022	MKLEPADLO	
&MFS=V1GL11UQ51UQ5+V1GL11UQ51/	Pallet Stop Station #5 Unload		12/21/2022	MKLEPADLO	

# Table of contents

Column X: An automatically generated page was edited

F06\_001

Page	Page description	supplementary page field	Date	Edited by	X
&MFS=V1GL11UQ51UQ6+V1GL11UQ51/	Pallet Stop Station #6 Mid-Stop #3		12/21/2022	MKLEPADLO	
&MFS=V1GL11UQ51UQ7+V1GL11UQ51/	Pallet Stop Station #7 Mid-Stop #4		12/21/2022	MKLEPADLO	
&MFS=V1GL11UQ51UQ8+V1GL11UQ51/	Pallet Stop Station #8 Mid-Stop #5		12/21/2022	MKLEPADLO	
&MFS=V1GL11UQ51UQ12+V1GL11UQ51/	Spare QN8		12/21/2022	MKLEPADLO	
&MFS=V1GL12+KH1/1	Incoming air supply (Fixture)		12/21/2022	MKLEPADLO	
&MFS=V1GL12UQ51KF2+V1GL12UQ51/	AIR SUPPLY CONFIGURATION		12/21/2022	MKLEPADLO	
&MFS=V1GL12UQ51KF2+V1GL12UQ51/	AIR SUPPLY		12/21/2022	MKLEPADLO	
&MFS=V1GL12UQ51UQ3+V1GL12UQ51/	Pallet Stop Station #3 Pre-Unload		12/21/2022	MKLEPADLO	
&MFS=V1GL12UQ51UQ4+V1GL12UQ51/	Pallet Stop Station #4 Unload		12/21/2022	MKLEPADLO	
&MFS=V1GL12UQ51UQ5+V1GL12UQ51/	Pallet Stop Station #5 Mid-Stop #2		12/21/2022	MKLEPADLO	
&MFS=V1GL12UQ51UQ6+V1GL12UQ51/	Pallet Stop Station #6 Mid-Stop #3		12/21/2022	MKLEPADLO	
&MFS=V1GL12UQ51UQ11+V1GL12UQ51/	Spare QN5		12/21/2022	MKLEPADLO	
&MFS=V1GL12UQ51UQ12+V1GL12UQ51/	Spare		12/21/2022	MKLEPADLO	
&MFS=V1GL13+KH1/1	Incoming air supply (Fixture)		12/21/2022	MKLEPADLO	
&MFS=V1GL13UQ51KF1+V1GL13UQ51/	AIR SUPPLY CONFIGURATION		12/20/2022	MKLEPADLO	
&MFS=V1GL13UQ51KF1+V1GL13UQ51/	AIR SUPPLY		12/20/2022	MKLEPADLO	
&MFS=V1GL13UQ51UQ1+V1GL13UQ51/	Pallet Stop Station #1 Load		12/20/2022	MKLEPADLO	
&MFS=V1GL13UQ51UQ2+V1GL13UQ51/	Pallet Stop Station #2 Mid-Stop #1		12/20/2022	MKLEPADLO	
&MFS=V1GL13UQ51UQ3+V1GL13UQ51/	Pallet Stop Station #3 Mid-Stop #2		12/20/2022	MKLEPADLO	
&MFS=V1GL13UQ51UQ4+V1GL13UQ51/	Pallet Stop Station #4 Mid-Stop #3		12/20/2022	MKLEPADLO	
&MFS=V1GL13UQ51UQ8+V1GL13UQ51/	Pallet Stop Station #8 Pre-Load		12/20/2022	MKLEPADLO	
&MFS=V1GL13UQ51UQx+V1GL13UQ51/	Spare		12/20/2022	MKLEPADLO	
&MFS=V1UQ51+KH1/1	Incoming air supply (Fixture)		12/21/2022	MKLEPADLO	
&MFS=V1UQ51KF1+V1UQ51/5	AIR SUPPLY CONFIGURATION		12/21/2022	MKLEPADLO	
&MFS=V1UQ51KF1+V1UQ51/11	AIR SUPPLY		12/21/2022	MKLEPADLO	
&MFS=V1UQ51KF2+V1UQ51/5	AIR SUPPLY CONFIGURATION		12/21/2022	MKLEPADLO	
&MFS=V1UQ51KF2+V1UQ51/11	AIR SUPPLY		12/21/2022	MKLEPADLO	
&MFS=V1UQ51KF3+V1UQ51/5	AIR SUPPLY CONFIGURATION		12/21/2022	MKLEPADLO	
&MFS=V1UQ51KF3+V1UQ51/11	AIR SUPPLY		12/21/2022	MKLEPADLO	
&MFS=V1UQ51UQ1+V1UQ51/1	L150 Model Shot Pins		12/21/2022	MKLEPADLO	
&MFS=V1UQ51UQ2+V1UQ51/1	Common Shot Pin 1		12/21/2022	MKLEPADLO	
&MFS=V1UQ51UQ3+V1UQ51/1	L150_230 Model Shot Pins		12/21/2022	MKLEPADLO	
&MFS=V1UQ51UQ4+V1UQ51/1	Common Clamps 1		12/21/2022	MKLEPADLO	

Date	12/21/2022	Volvo Trucks North America	Valiant TMS	Table of contents :	Drawing name:	=
Ed.	MKLEPADLO			&MFS=V1GL11UQ51UQ6+V1GL11UQ51/1 -	=2V04&MFS-PNEU	+
Appr		P6700 Underbody Mainline - Cell 2V04		&MFS=V1UQ51UQ4+V1UQ51/1	Document type:	
Original		Replacement of	Replaced by	Scale 1:1	MAB	
Modification	Date	Name			Project nr:	Page
					22-16151	4
						227



# Table of contents

Column X: An automatically generated page was edited

F06\_001

Page	Page description	supplementary page field	Date	Edited by	X
&MFS=V1UQ51UQ5+V1UQ51/1	Common Y-Slides		12/21/2022	MKLEPADLO	
&MFS=V1UQ51UQ6+V1UQ51/1	Common Shot Pins 2		12/21/2022	MKLEPADLO	
&MFS=V1UQ51UQ7+V1UQ51/1	Common Clamps 2		12/21/2022	MKLEPADLO	
&MFS=V1UQ51UQ8+V1UQ51/1	L150 Model Clamps 1		12/21/2022	MKLEPADLO	
&MFS=V1UQ51UQ9+V1UQ51/1	Common Clamps 3		12/21/2022	MKLEPADLO	
&MFS=V1UQ51UQ10+V1UQ51/1	Common Clamps 4		12/21/2022	MKLEPADLO	
&MFS=V1UQ51UQ11+V1UQ51/1	L150 Model Clamp 2		12/21/2022	MKLEPADLO	
&MFS=V1UQ51UQ12+V1UQ51/1	L230 Model Shot Pin 1		12/21/2022	MKLEPADLO	
&MFS=V1UQ51UQ13+V1UQ51/1	L230 Model Shot Pin 2		12/21/2022	MKLEPADLO	
&MFS=V1UQ51UQ14+V1UQ51/1	L230/290 Model Clamps		12/21/2022	MKLEPADLO	
&MFS=V1UQ51UQ15+V1UQ51/1	L230/290/320 Model Clamps		12/21/2022	MKLEPADLO	
&MFS=V1UQ51UQ16+V1UQ51/1	L230 Model Clamp		12/21/2022	MKLEPADLO	
&MFS=V1UQ51UQ17+V1UQ51/1	L290/320 Model X-Slide 1		12/21/2022	MKLEPADLO	
&MFS=V1UQ51UQ18+V1UQ51/1	L290/320 Model X-Slide 2		12/21/2022	MKLEPADLO	
&MFS=V1UQ51UQ19+V1UQ51/1	L290 Model Clamps 1		12/21/2022	MKLEPADLO	
&MFS=V1UQ51UQ20+V1UQ51/1	L320 Model Shot Pins		12/21/2022	MKLEPADLO	
&MFS=V1UQ51UQ21+V1UQ51/1	L290 Model Clamps 2		12/21/2022	MKLEPADLO	
&MFS=V1UQ51UQ22+V1UQ51/1	L290/320 Model Clamps 1		12/21/2022	MKLEPADLO	
&MFS=V1UQ51UQ23+V1UQ51/1	L290 Model Clamp 3		12/21/2022	MKLEPADLO	
&MFS=V1UQ51UQ24+V1UQ51/1	L290/320 Model Clamp 2		12/21/2022	MKLEPADLO	
&MFS=V1UQ52+KH1/1	Incoming air supply (Fixture)		12/21/2022	MKLEPADLO	
&MFS=V1UQ52KF1+V1UQ52/5	AIR SUPPLY CONFIGURATION		12/21/2022	MKLEPADLO	
&MFS=V1UQ52KF1+V1UQ52/11	AIR SUPPLY		12/21/2022	MKLEPADLO	
&MFS=V1UQ52UQ1+V1UQ52/1	Common Clamps		12/21/2022	MKLEPADLO	
&MFS=V1UQ52UQ2+V1UQ52/1	L150 Model Clamps		12/21/2022	MKLEPADLO	
&MFS=V1UQ52UQ3+V1UQ52/1	L150 Model Shot Pin		12/21/2022	MKLEPADLO	
&MFS=V1UQ52UQ4+V1UQ52/1	L230/290/320 Model Clamps		12/21/2022	MKLEPADLO	
&MFS=V1UQ52UQ5+V1UQ52/1	L230/290/320 Mod Select Slide		12/21/2022	MKLEPADLO	
&MFS=V1UQ52UQ6+V1UQ52/1	L290 Model Slide Lock Clamp		12/21/2022	MKLEPADLO	
&MFS=V1UQ53+KH1/1	Incoming air supply (Fixture)		12/21/2022	MKLEPADLO	
&MFS=V1UQ53KF1+V1UQ53/5	AIR SUPPLY CONFIGURATION		12/21/2022	MKLEPADLO	
&MFS=V1UQ53KF1+V1UQ53/11	AIR SUPPLY		12/21/2022	MKLEPADLO	
&MFS=V1UQ53UQ1+V1UQ53/1	Common Clamps		12/21/2022	MKLEPADLO	

# Table of contents

Column X: An automatically generated page was edited

F06\_001

Page	Page description	supplementary page field	Date	Edited by	X
&MFS=V1UQ53UQ2+V1UQ53/1	L150 Model Clamps		12/21/2022	MKLEPADLO	
&MFS=V1UQ53UQ3+V1UQ53/1	L150 Model Shot Pin		12/21/2022	MKLEPADLO	
&MFS=V1UQ53UQ4+V1UQ53/1	L230/290/320 Model Clamps		12/21/2022	MKLEPADLO	
&MFS=V1UQ53UQ5+V1UQ53/1	L230/290/320 Mod Select Slide		12/21/2022	MKLEPADLO	
&MFS=V1UQ53UQ6+V1UQ53/1	L290 Model Slide Lock Clamp		12/21/2022	MKLEPADLO	
&MFS=V1UQ54+KH1/1	Incoming air supply (Fixture)		12/21/2022	MKLEPADLO	
&MFS=V1UQ54KF1+V1UQ54/5	AIR SUPPLY CONFIGURATION		12/21/2022	MKLEPADLO	
&MFS=V1UQ54KF1+V1UQ54/11	AIR SUPPLY		12/21/2022	MKLEPADLO	
&MFS=V1UQ54UQ1+V1UQ54/1	L150 Model Shot Pin		12/21/2022	MKLEPADLO	
&MFS=V1UQ54UQ2+V1UQ54/1	L230 Model Shot Pins		12/21/2022	MKLEPADLO	
&MFS=V1UQ54UQ3+V1UQ54/1	L290 Model Shot Pins		12/21/2022	MKLEPADLO	
&MFS=V1UQ54UQ4+V1UQ54/1	Common Shot Pin		12/21/2022	MKLEPADLO	
&MFS=V1UQ55+KH1/1	Incoming air supply (Fixture)		12/21/2022	MKLEPADLO	
&MFS=V1UQ55KF1+V1UQ55/5	AIR SUPPLY CONFIGURATION		12/21/2022	MKLEPADLO	
&MFS=V1UQ55KF1+V1UQ55/11	AIR SUPPLY		12/21/2022	MKLEPADLO	
&MFS=V1UQ55UQ1+V1UQ55/1	Common Clamps		12/21/2022	MKLEPADLO	
&MFS=V1UQ55UQ2+V1UQ55/1	L150 Model Shot Pins		12/21/2022	MKLEPADLO	
&MFS=V1UQ55UQ3+V1UQ55/1	L150 Model Clamps		12/21/2022	MKLEPADLO	
&MFS=V1UQ55UQ4+V1UQ55/1	L230 Model Shot Pins		12/21/2022	MKLEPADLO	
&MFS=V1UQ55UQ5+V1UQ55/1	L230 Model Clamps		12/21/2022	MKLEPADLO	
&MFS=V1UQ55UQ6+V1UQ55/1	L290 Model Shot Pins		12/21/2022	MKLEPADLO	
&MFS=V1UQ55UQ7+V1UQ55/1	L290 Model Clamps		12/21/2022	MKLEPADLO	
&MFS=V1UQ55UQ8+V1UQ55/1	L320 Model Shot Pins		12/21/2022	MKLEPADLO	
&MFS=V1UQ55UQ9+V1UQ55/1	L320 Model Clamps		12/21/2022	MKLEPADLO	
&MFS=V1UQ55UQ10+V1UQ55/1	Spare		12/21/2022	MKLEPADLO	
&MFS=V1WR1+KH1/1	Incoming air supply (Trunnion)		12/21/2022	MKLEPADLO	
&MFS=V1WR1UQ51KF1+V1WR1UQ51/5	AIR SUPPLY CONFIGURATION		12/21/2022	MKLEPADLO	
&MFS=V1WR1UQ51KF1+V1WR1UQ51/11	AIR SUPPLY		12/21/2022	MKLEPADLO	
&MFS=V1WR1UQ51UQ1+V1WR1UQ51/1	Common Pin Clamps		12/21/2022	MKLEPADLO	
&MFS=V1WR1UQ51UQ2+V1WR1UQ51/1	Common Clamps		12/21/2022	MKLEPADLO	
&MFS=V1WR1UQ51UQ3+V1WR1UQ51/1	L150 Model Clamps		12/21/2022	MKLEPADLO	
&MFS=V1WR1UQ51UQ4+V1WR1UQ51/1	L230 Model Clamps		12/21/2022	MKLEPADLO	
&MFS=V1WR1UQ51UQ5+V1WR1UQ51/1	L290 Model Clamps		12/21/2022	MKLEPADLO	

Date	12/21/2022	Volvo Trucks North America	Valiant TMS	Table of contents : &MFS=V1UQ53UQ2+V1UQ53/1	Drawing name:	=
Ed.	MKLEPADLO			- &MFS=V1WR1UQ51UQ5+V1WR1UQ51/1	=2V04&MFS-PNEU	+
Appr		P6700 Underbody Mainline - Cell 2V04			Document type:	Project nr:
Modification	Date	Name	Original	Replacement of	MAB	22-16151
				Replaced by		Page 6
				Scale 1:1		227





**A1**  
 535031  
 535025  
 541681  
 537133  
 8035544  
 572577  
 8030308

From drop point

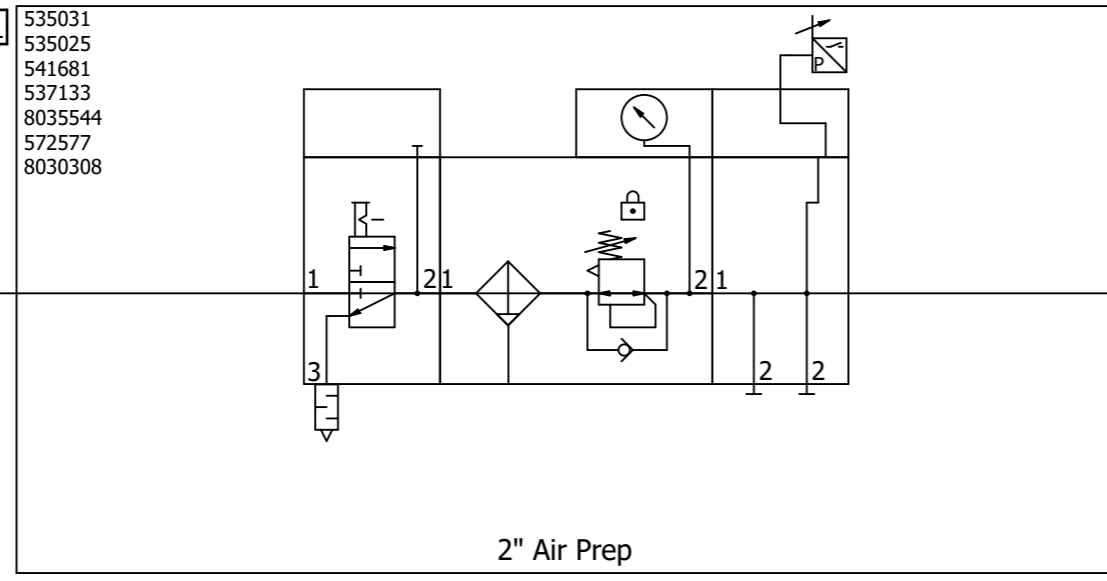

2" Air Prep

2.5"

1"

2.5"

1/2"

2.5"

1/2"

2.5"

1/2"

2.5"

1/2"

2.5"

1/2"

2.5"

1/2"

2.5"

1/2"

2.5"

1/2"

2.5"

1/2"

2.5"

1/2"

2.5"

1/2"

+V1UQ51KH1-P1 / =V1UQ51+KH1/1.1

+V1UQ52KH1-P1 / =V1UQ52+KH1/1.1

+V1UQ53KH1-P1 / =V1UQ53+KH1/1.1

+V1UQ54KH1-P1 / =V1UQ54+KH1/1.1

+V1UQ55KH1-P1 / =V1UQ55+KH1/1.1

+V1WR1KH1-P1 / =V1WR1+KH1/1.1

+V1GL11KH1-P1 / =V1GL11+KH1/1.1

+V1GL12KH1-P1 / =V1GL12+KH1/1.1

+V1GL13KH1-P1 / =V1GL13+KH1/1.1

V1AR11 /  
Robot Media Panel

V1AR12 /  
Robot Media Panel

V1AR13 /  
Robot Media Panel

V1AR14 /  
Robot Media Panel

=V1AR11UQ41KF1+V1AR11UQ41/1

&MAB+/7

Date		12/21/2022		Volvo Trucks North America		Valiant TMS		Incoming air supply		Drawing name: =2V04&MFS-PNEU		= KH0	
Ed.		MKLEPADLO		P6700 Underbody Mainline - Cell 2V04		Scale 1:1				Document type: MFS		Project nr: 22-16151	
Appr.				Replacement of		Replaced by				Page		1	
Modification		Date		Name		Original				Page		227	

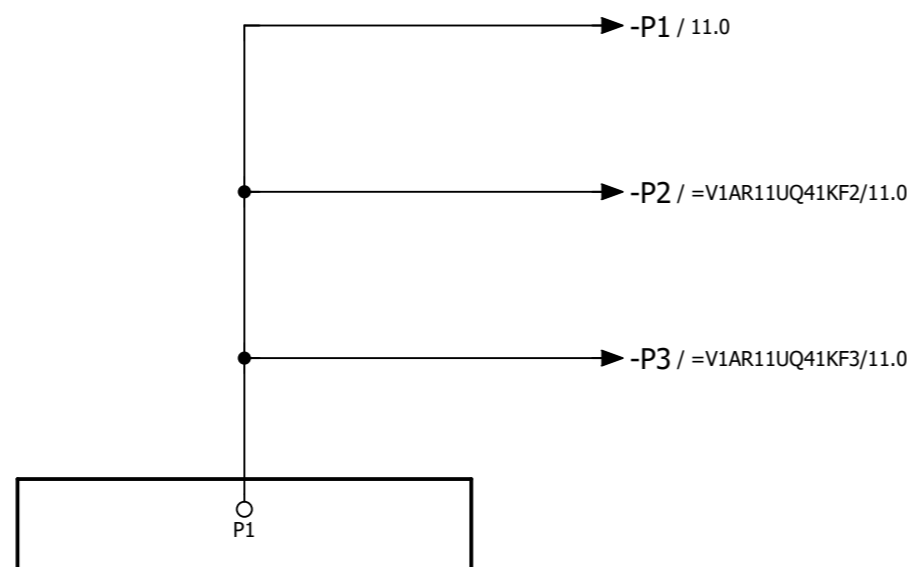

		Date	12/21/2022	Volvo Trucks North America			Valiant TMS	AIR SUPPLY GRIPPER	Drawing name:		= V1AR11UQ41KF1
		Ed.	MKLEPADLO	P6700 Underbody Mainline - Cell 2V04					=2V04&MFS-PNEU		+ V1AR11UQ41
		Appr.		Replacement of		Replaced by	Scale 1:1		Document type:	Project nr:	Page
Modification	Date	Name	Original						MFS	22-16151	1
											227

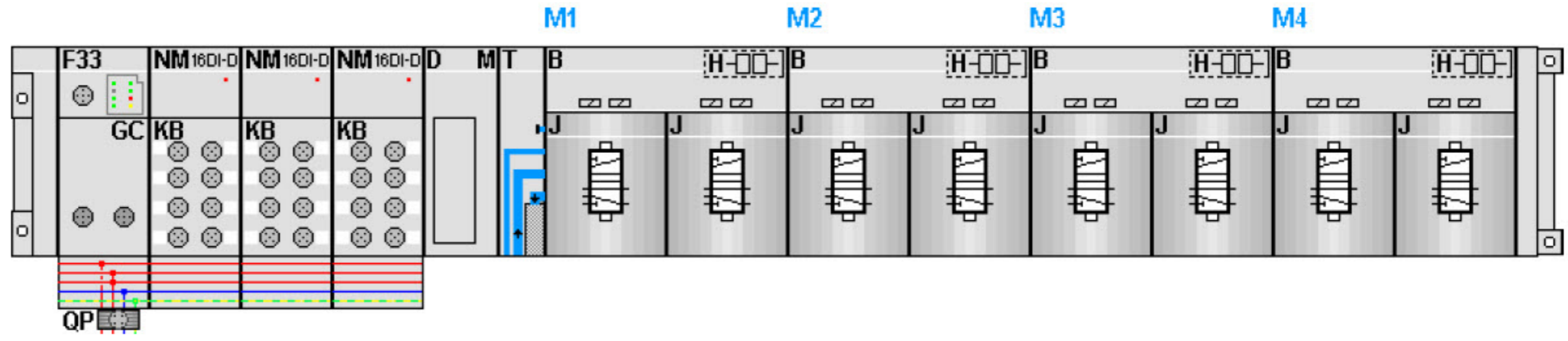

KF1.0

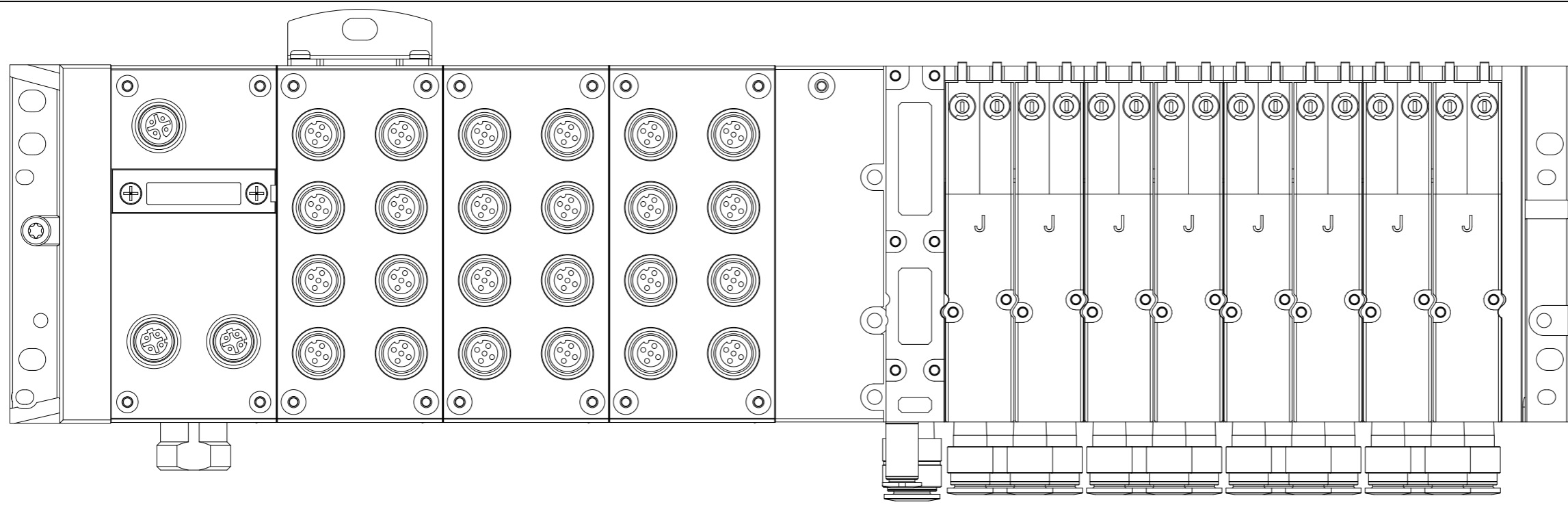

Date		12/21/2022		Volvo Trucks North America		Valiant TMS		AIR SUPPLY		Drawing name:		= V1AR11UQ41KF1	
Ed.		MKLEPADLO		P6700 Underbody Mainline - Cell 2V04		Scale 1:1				Document type:		+ V1AR11UQ41	
Appr				Replacement of		Replaced by				Project nr:		Page	
Original										22-16151		5	
Modification		Date		Name						MFS		227	





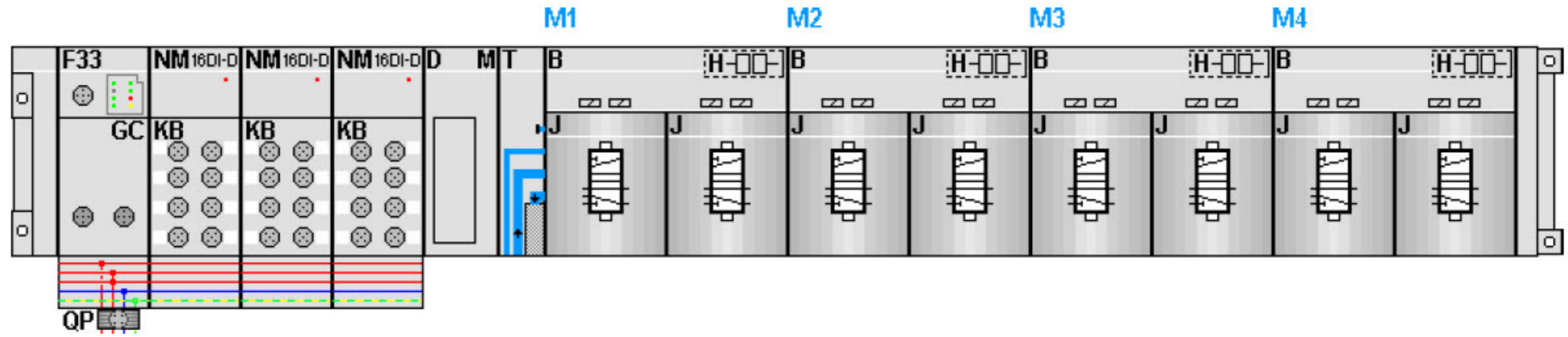

KF2.0

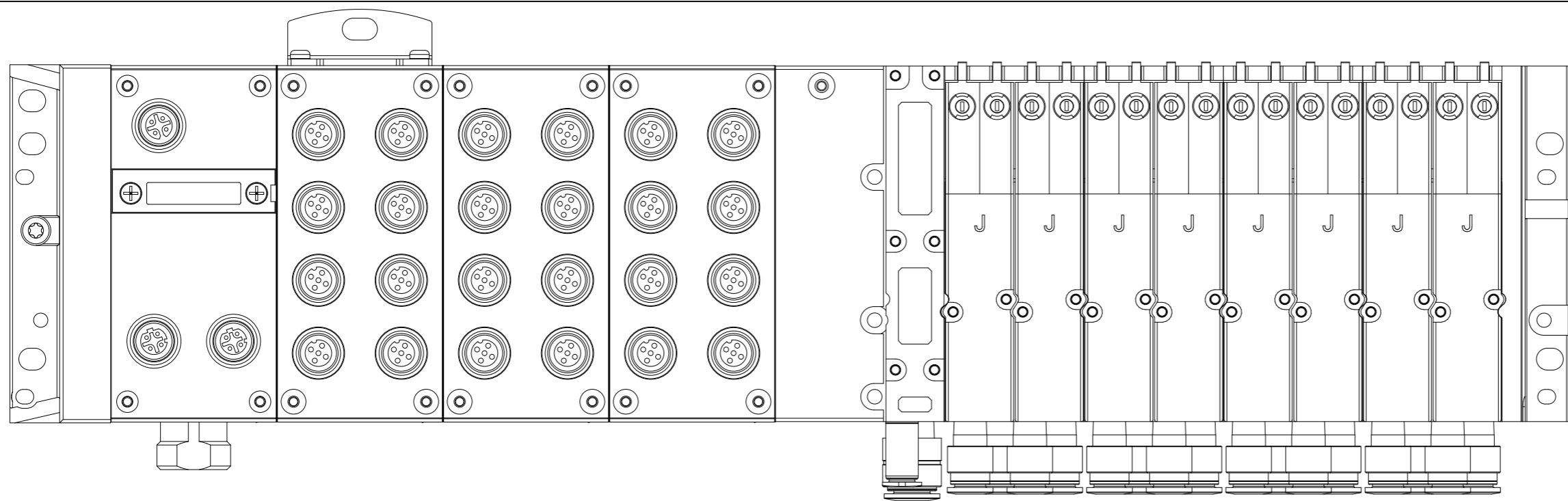

=V1AR11UQ41KF1/11

Date		12/21/2022		Volvo Trucks North America		Valiant TMS		AIR SUPPLY		Drawing name:		= V1AR11UQ41KF2	
Ed.		MKLEPADLO		P6700 Underbody Mainline - Cell 2V04		Scale 1:1				Document type:		= 2V04&MFS-PNEU	
Appr				Replacement of		Replaced by				Project nr:		+ V1AR11UQ41	
Modification	Date	Name	Original									Page	5
													227

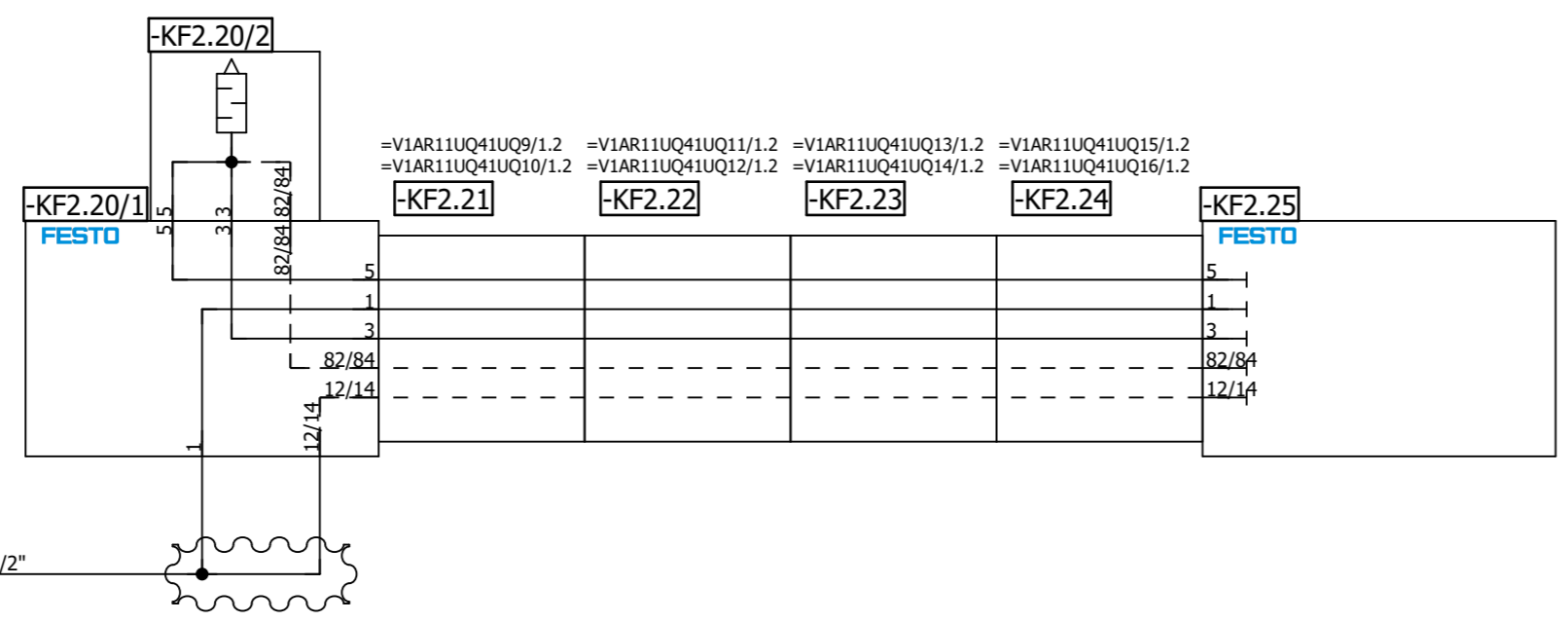
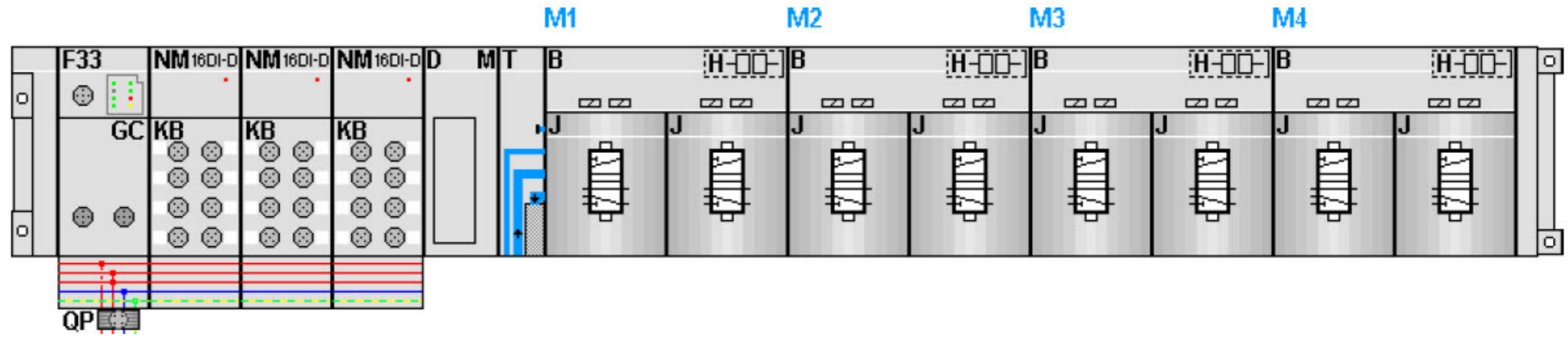

Date		12/21/2022	Volvo Trucks North America		Valiant TMS		AIR SUPPLY		Drawing name:		= V1AR11UQ41KF2	
Ed.		MKLEPADLO	P6700 Underbody Mainline - Cell 2V04		Scale 1:1				=2V04&MFS-PNEU		+ V1AR11UQ41	
Appr.			Replacement of		Replaced by				Document type:		Project nr:	
Original									MFS		22-16151	
Modification		Date	Name								Page	
											11	
											227	

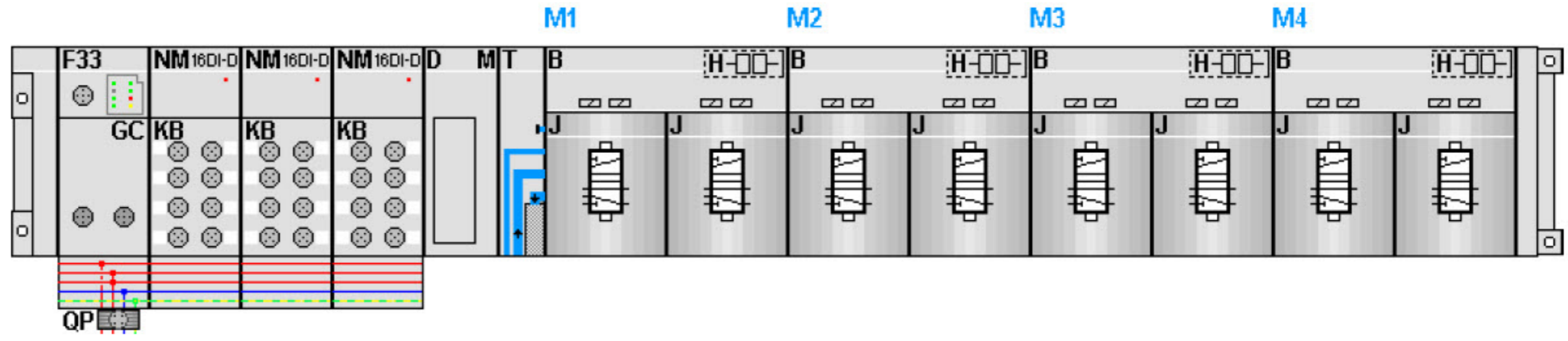

KF3.0

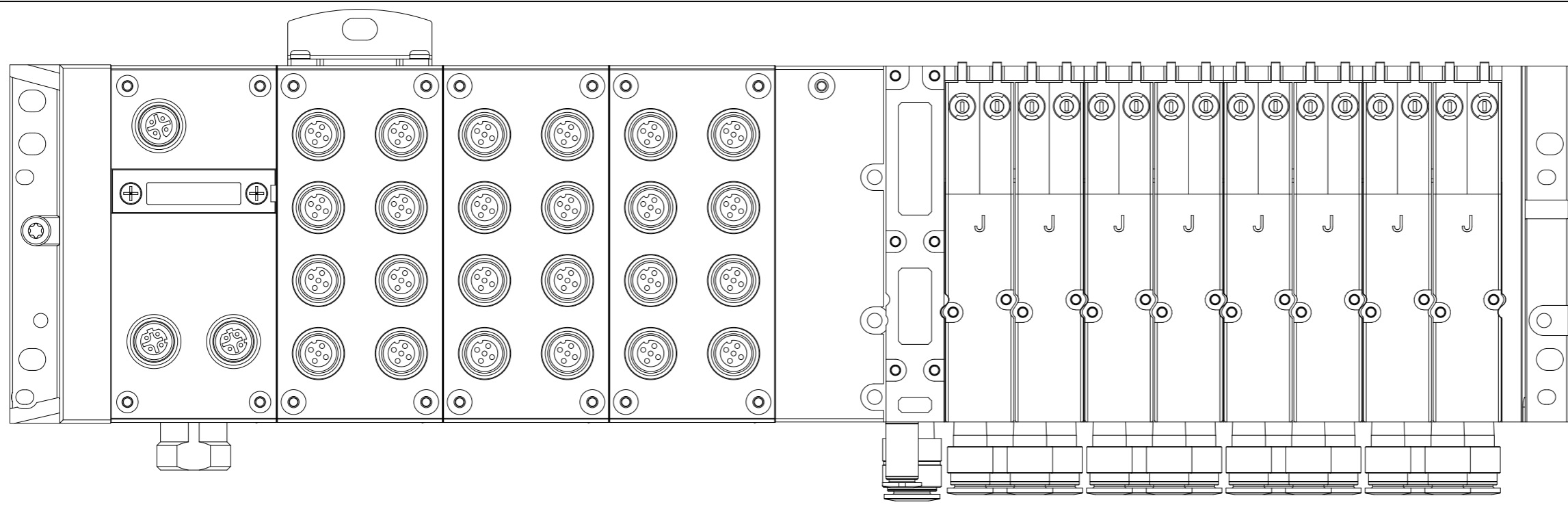

=V1AR11UQ41KF2/11

Date		12/21/2022	Volvo Trucks North America		Valiant TMS		AIR SUPPLY		Drawing name:		= V1AR11UQ41KF3	
Ed.		MKLEPADLO	P6700 Underbody Mainline - Cell 2V04		Scale 1:1				=2V04&MFS-PNEU		+ V1AR11UQ41	
Appr			Replacement of		Replaced by				Document type:		Project nr:	
Modification	Date	Name	Original						MFS	22-16151	Page	5
												227





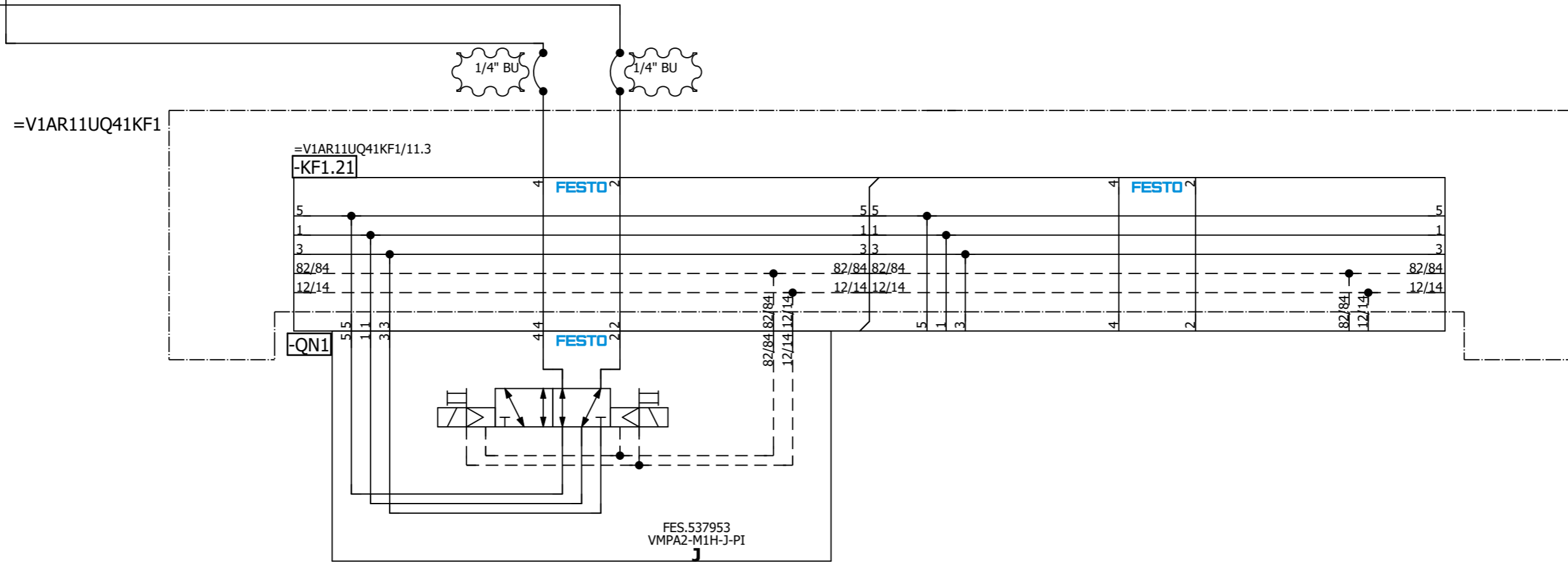
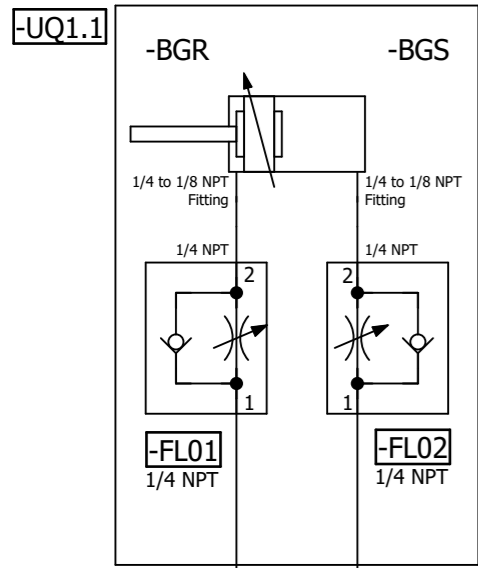

=V1AR11UQ41  
-UQ1-QN1.1  
Common  
Shot Pins (RST)

=V1AR11UQ41  
-UQ1-QN1.2  
Common  
Shot Pins (SET)

=V1AR11UQ41KF3/11

=V1AR11UQ41UQ2/1

Date		12/21/2022		Volvo Trucks North America		Valiant TMS		Common Shot Pin		Drawing name:		= V1AR11UQ41UQ1	
Ed.		MKLEPADLO		P6700 Underbody Mainline - Cell 2V04		Scale 1:1				Document type:		= 2V04&MFS-PNEU	
Appr				Replacement of		Replaced by				Project nr:		+ V1AR11UQ41	
Modification		Date		Name		Original				MFS		Page 1	
										22-16151		227	



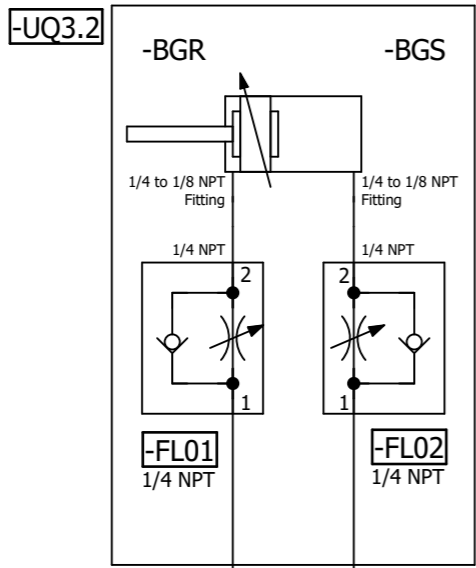
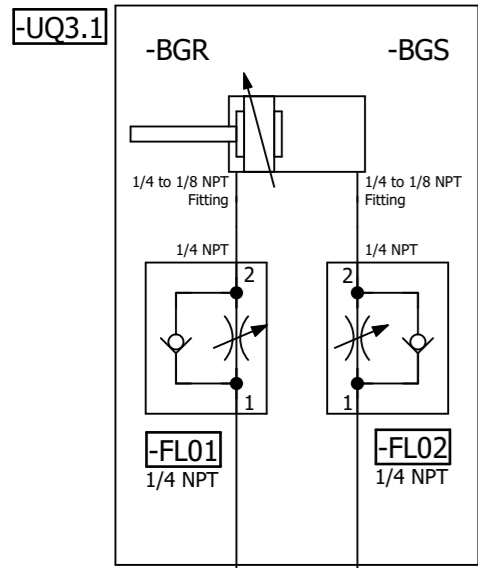

=V1AR11UQ41KF1

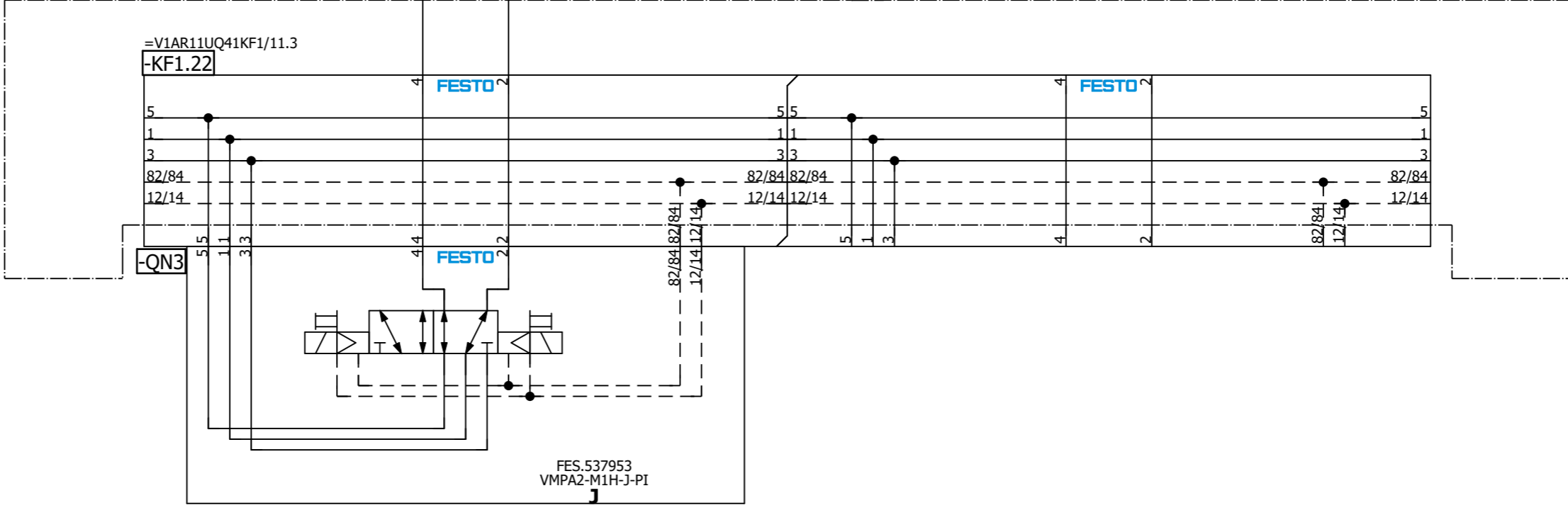

**=V1AR11UQ41**  
**-UQ3-QN3.1**  
**L150 Model**  
**Shot Pins (RST)**

**=V1AR11UQ41**  
**-UQ3-QN3.2**  
**L150 Model**  
**Shot Pins (SET)**

=V1AR11UQ41UQ2/1

=V1AR11UQ41UQ4/1

Date: 12/21/2022		Volvo Trucks North America		Valiant TMS		Drawing name: =2V04&MFS-PNEU		= V1AR11UQ41UQ3	
Ed.: MKLEPADLO		P6700 Underbody Mainline - Cell 2V04		L150 Model Shot Pins		Document type: MFS		+ V1AR11UQ41	
Appr:		Replacement of		Scale 1:1		Project nr: 22-16151		Page 1	
Original		Replaced by						227	





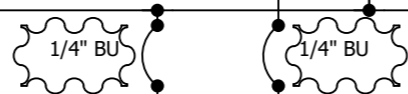
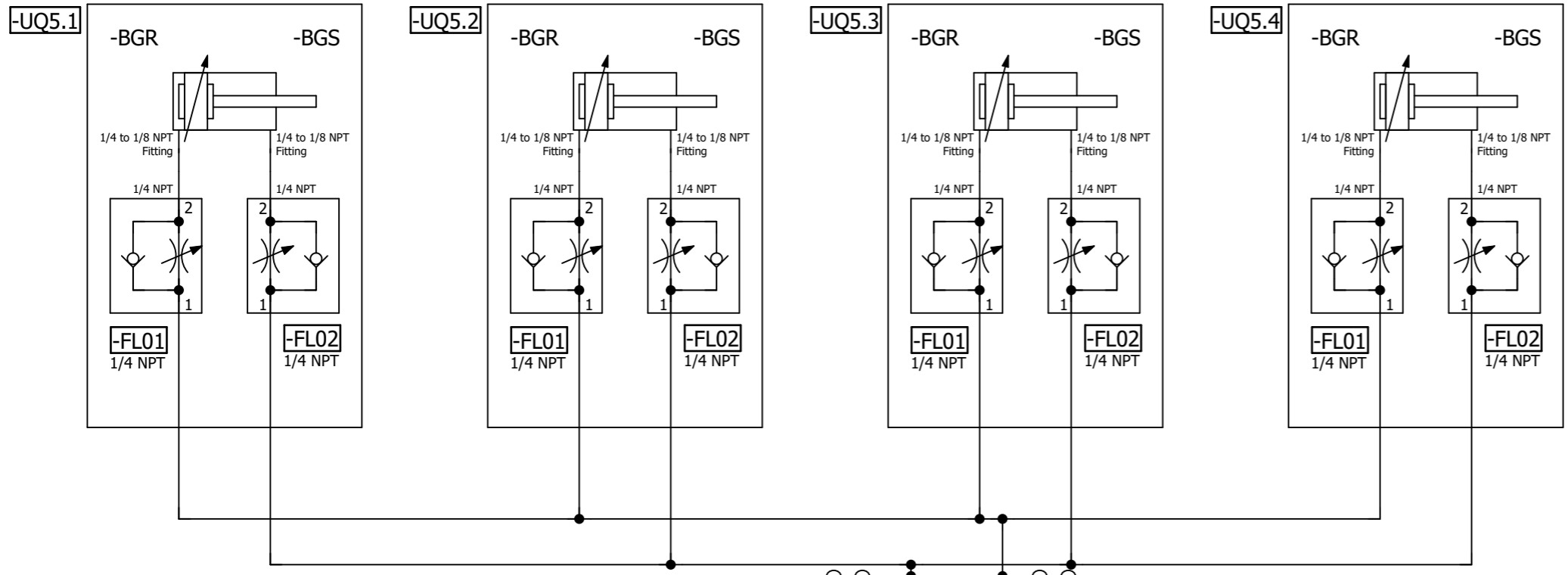

=V1AR11UQ41KF1

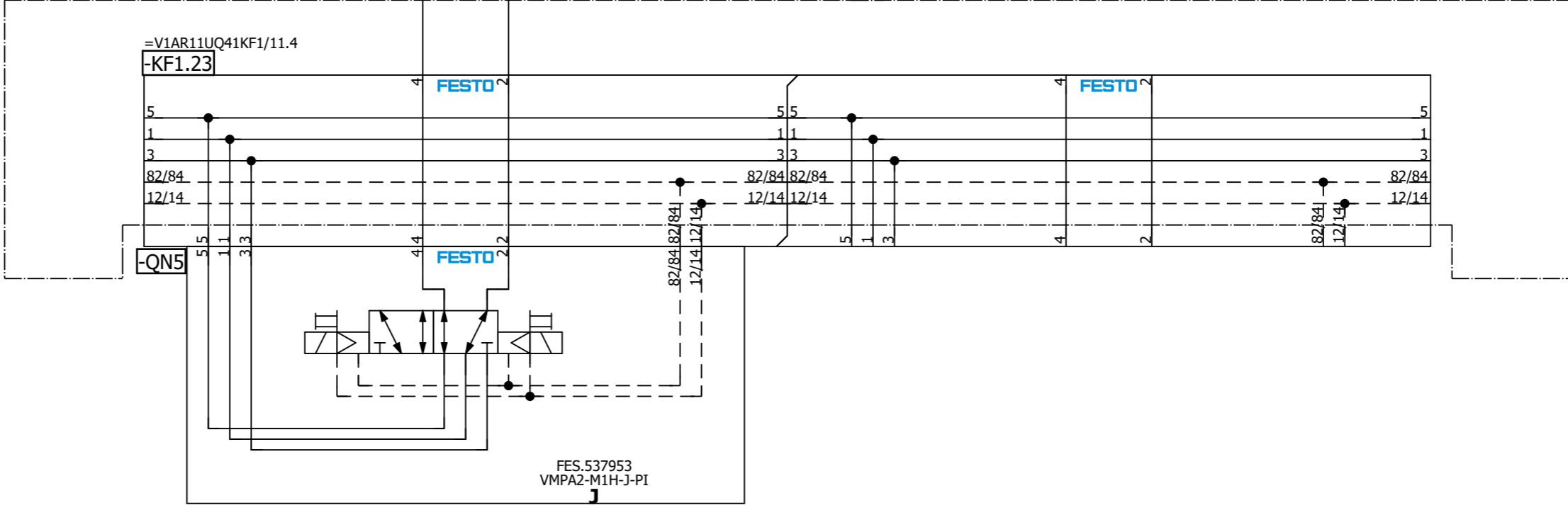

=V1AR11UQ41  
-UQ5-QN5.1  
Common  
Clamps 2 (RST)

=V1AR11UQ41  
-UQ5-QN5.2  
Common  
Clamps 2 (SET)

=V1AR11UQ41UQ4/1

=V1AR11UQ41UQ6/1

Date: 12/21/2022		Volvo Trucks North America		Valiant TMS		Drawing name: =2V04&MFS-PNEU		= V1AR11UQ41UQ5	
Ed.: MKLEPADLO		P6700 Underbody Mainline - Cell 2V04		Scale 1:1		Document type: MFS		+ V1AR11UQ41	
Appr:		Replacement of:		Replaced by:		Project nr: 22-16151		Page 1	
Original:								227	



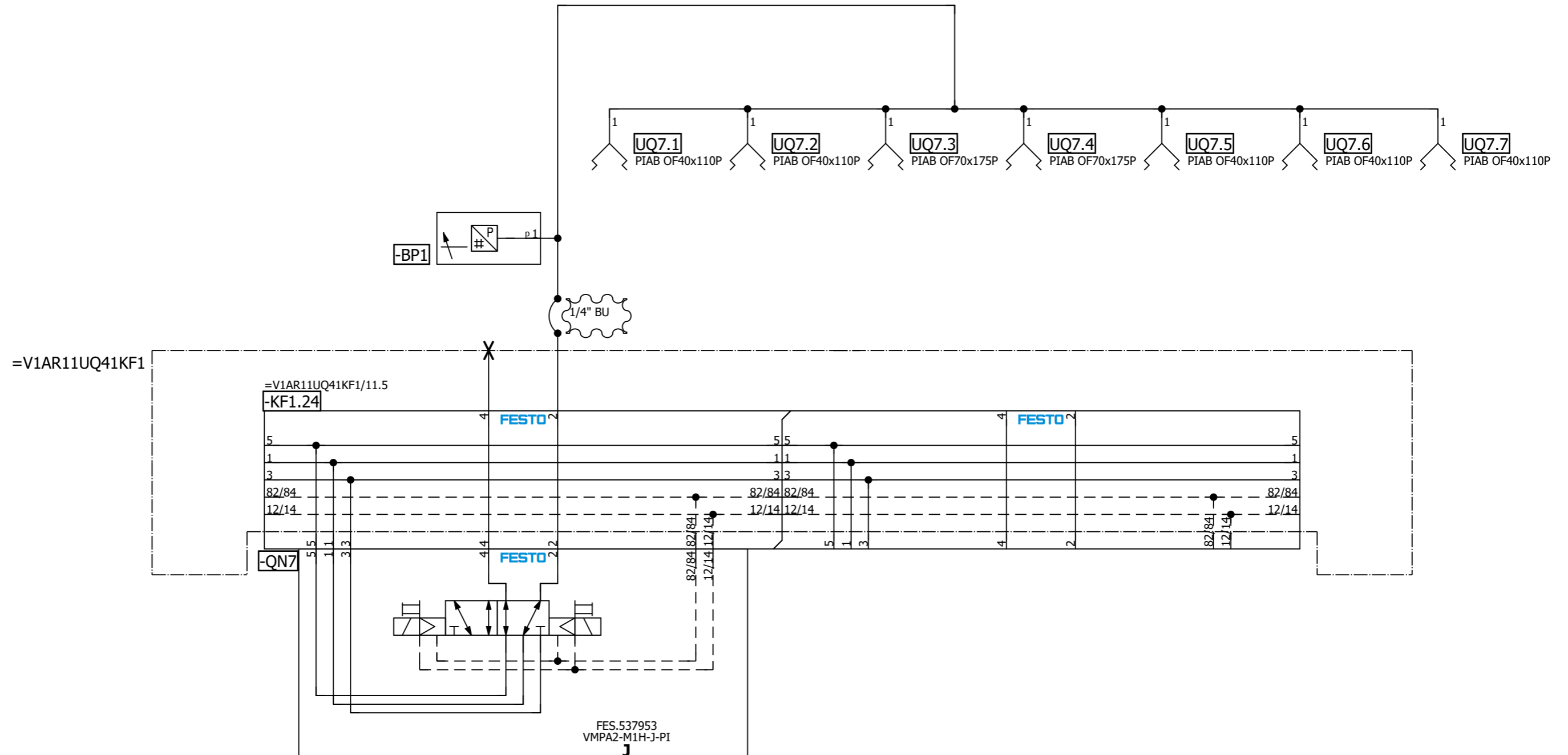

=V1AR11UQ41  
-UQ7-QN7.1  
Common  
Vacuums (RST)

=V1AR11UQ41  
-UQ7-QN7.2  
Common  
Vacuums (SET)

=V1AR11UQ41UQ6/1

=V1AR11UQ41UQ8/1

Date		12/21/2022		Volvo Trucks North America		Valiant TMS		Common Vacuums		Drawing name:		= V1AR11UQ41UQ7	
Ed.		MKLEPADLO		P6700 Underbody Mainline - Cell 2V04		Scale 1:1				Document type:		= 2V04&MFS-PNEU	
Appr.				Replacement of		Replaced by				Project nr:		+ V1AR11UQ41	
Modification		Date		Name		Original				MFS		Page 1	
										22-16151		227	

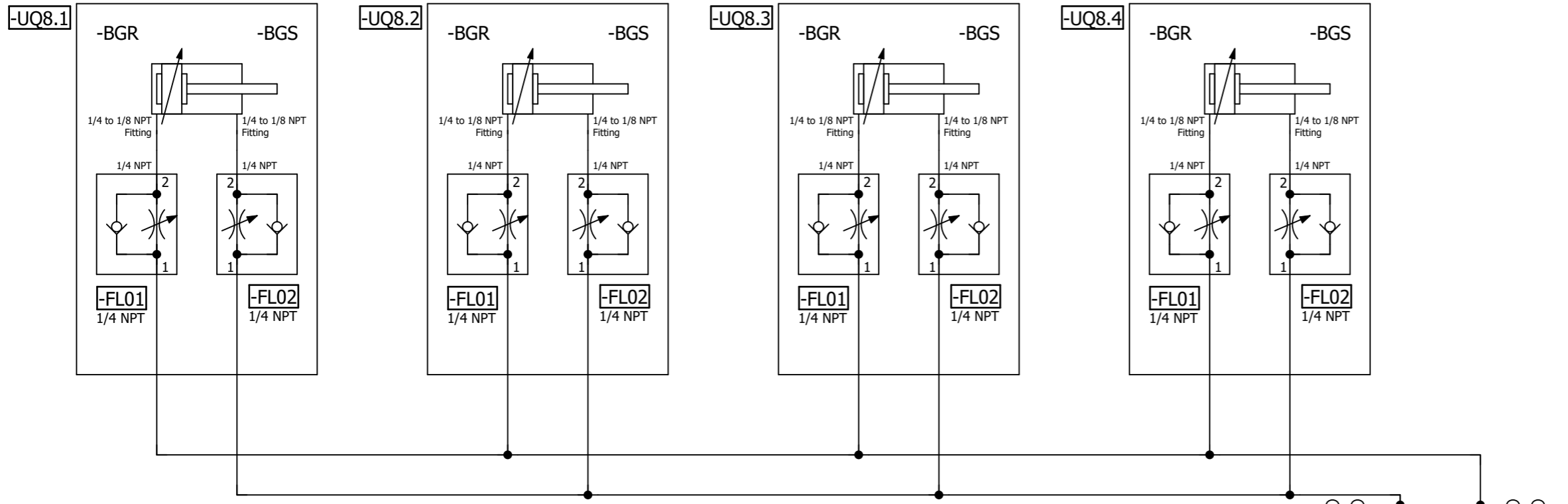

=V1AR11UQ41KF1

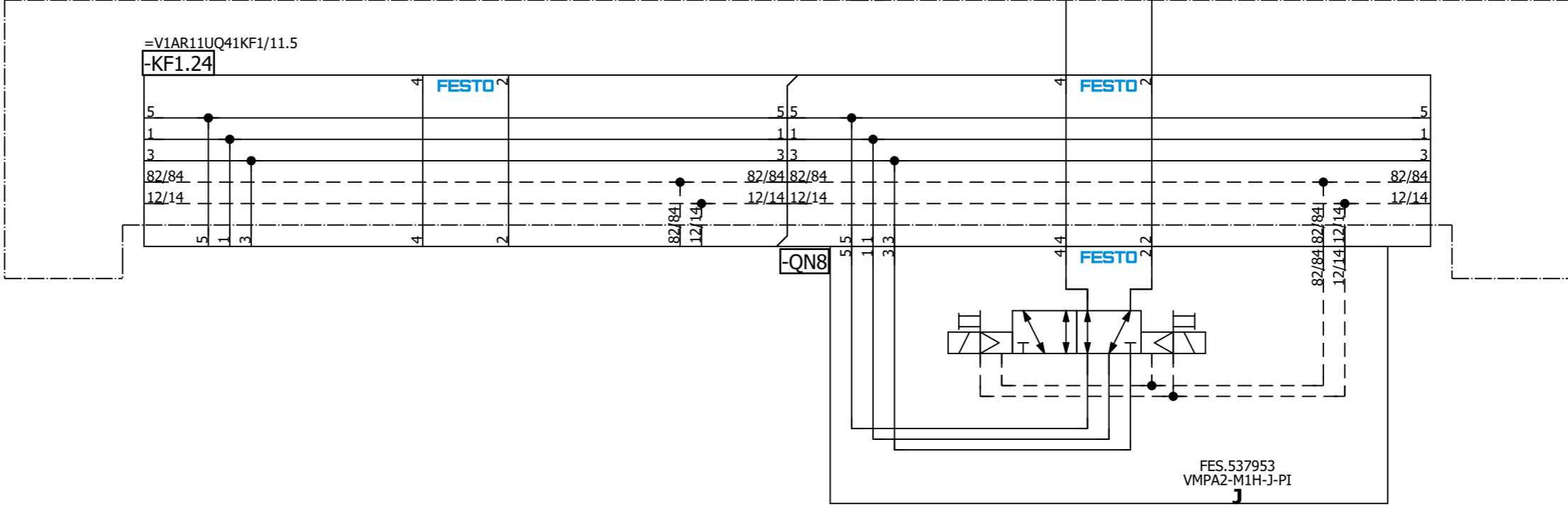

=V1AR11UQ41  
-UQ8-QN8.1  
Common  
Clamps 4 (RST)

=V1AR11UQ41  
-UQ8-QN8.2  
Common  
Clamps 4 (SET)

=V1AR11UQ41UQ7/1

=V1AR11UQ41UQ9/1

Date: 12/21/2022		Volvo Trucks North America		Valiant TMS		Common Clamps 4		Drawing name: =2V04&MFS-PNEU		= V1AR11UQ41UQ8	
Ed.: MKLEPADLO		P6700 Underbody Mainline - Cell 2V04		Scale 1:1				Document type: MFS		+ V1AR11UQ41	
Appr:		Replacement of		Replaced by				Project nr: 22-16151		Page 1	
Original										227	

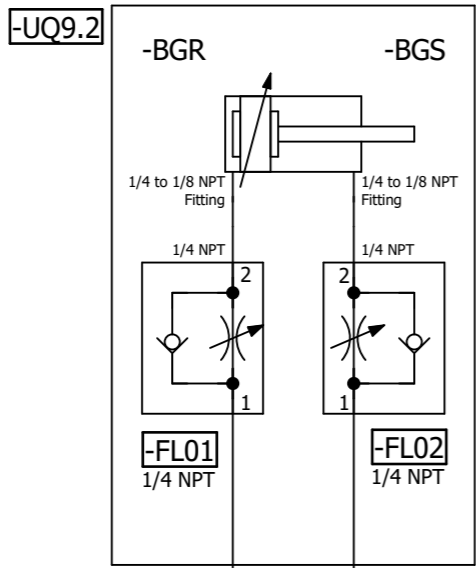
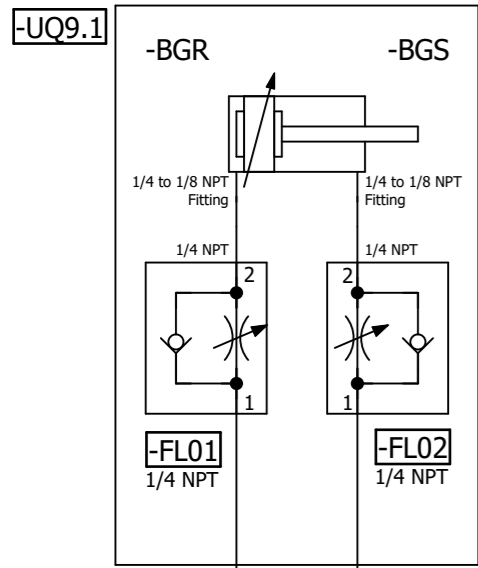

=V1AR11UQ41KF2

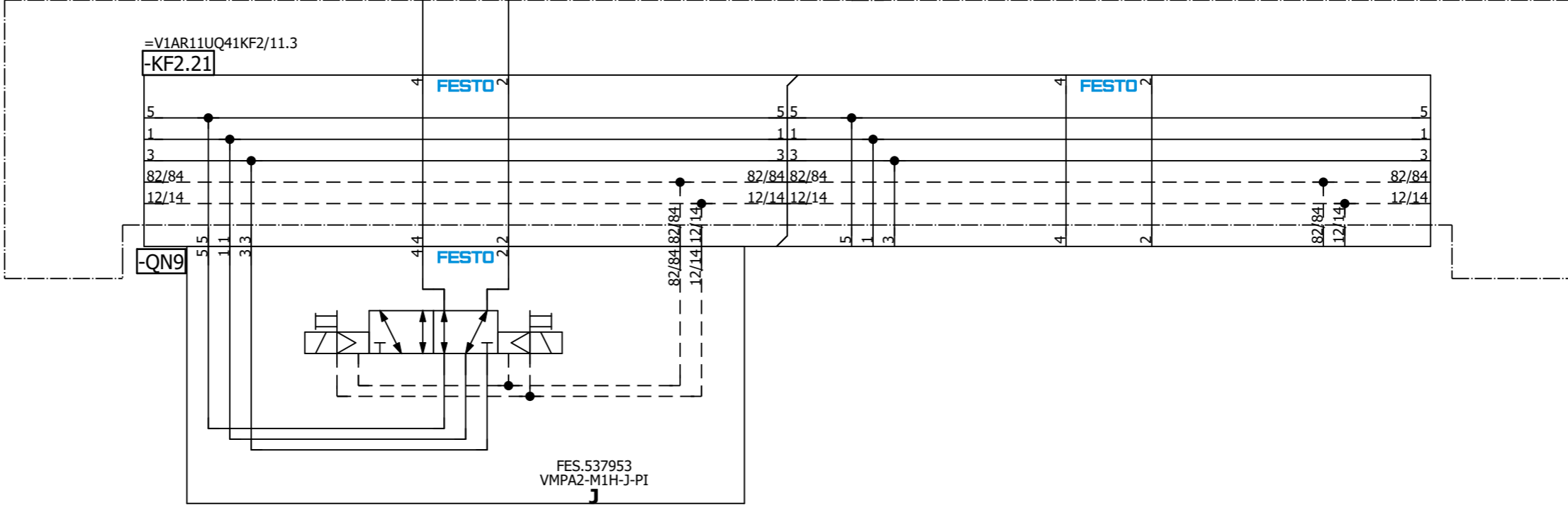

=V1AR11UQ41  
-UQ9-QN9.1  
L230/290/320  
Clamps (RST)

=V1AR11UQ41  
-UQ9-QN9.2  
L230/290/320  
Clamps (SET)

=V1AR11UQ41UQ8/1

=V1AR11UQ41UQ10/1

Date: 12/21/2022		Volvo Trucks North America		Valiant TMS		Drawing name: =2V04&MFS-PNEU		= V1AR11UQ41UQ9	
Ed.: MKLEPADLO		P6700 Underbody Mainline - Cell 2V04		L230/290/320 Model Clamps		Document type: MFS		+ V1AR11UQ41	
Appr:		Replacement of		Scale 1:1		Project nr: 22-16151		Page 1	
Original		Replaced by						227	

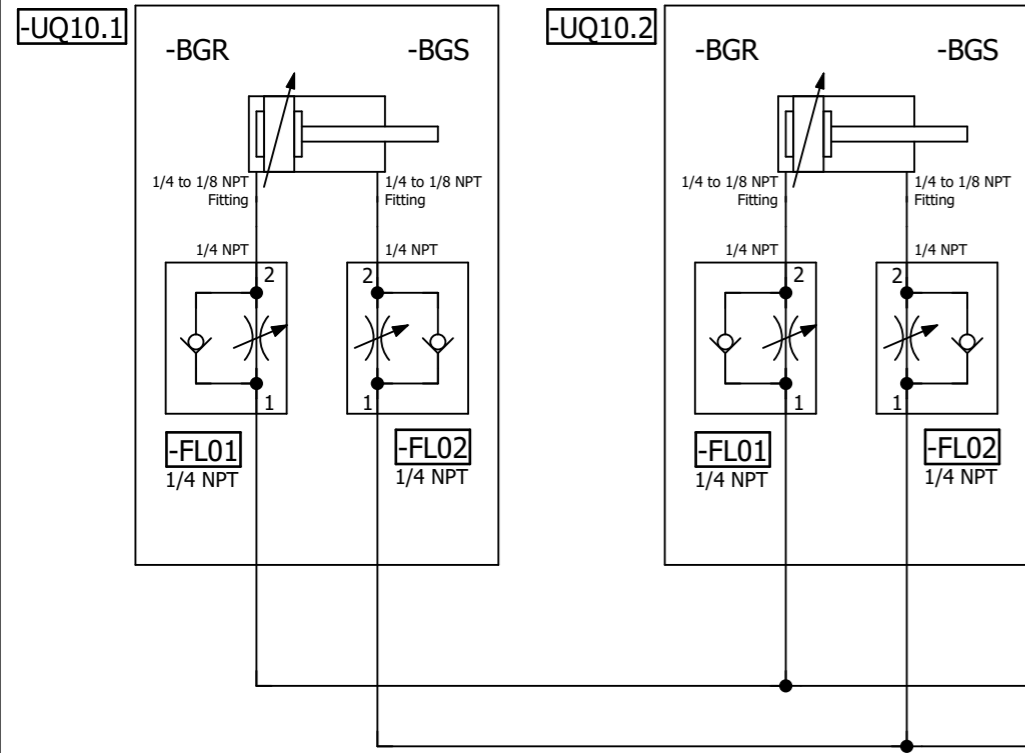

=V1AR11UQ41KF2

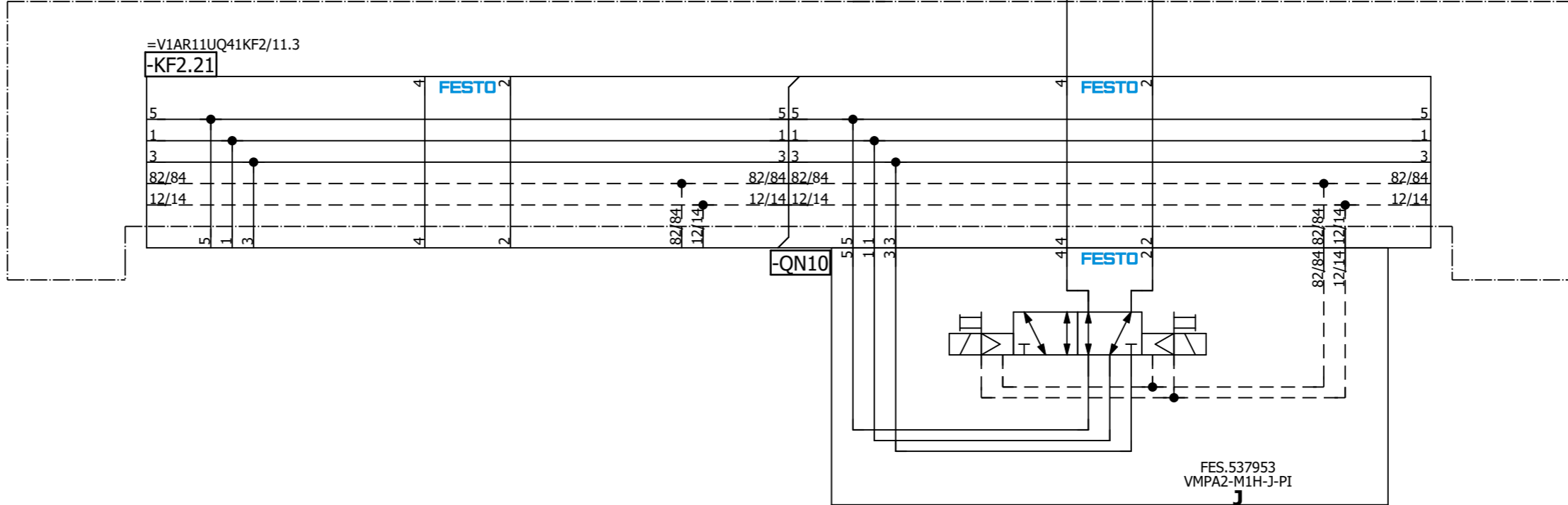

=V1AR11UQ41  
-UQ10-QN10.1  
L230/320 Model  
Clamps (RST)

=V1AR11UQ41  
-UQ10-QN10.2  
L230/320 Model  
Clamps (SET)

=V1AR11UQ41UQ11/1

=V1AR11UQ41UQ9/1			Date	12/21/2022	Volvo Trucks North America	Valiant TMS	L230/320 Model Clamps	Drawing name:	= V1AR11UQ41UQ10	Page	1
			Ed.	MKLEPADLO		Scale 1:1		Drawing type:	= 2V04&MFS-PNEU	Project nr:	22-16151
			Appr.					Replacement of	Replaced by		
Modification	Date	Name	Original						+ V1AR11UQ41		



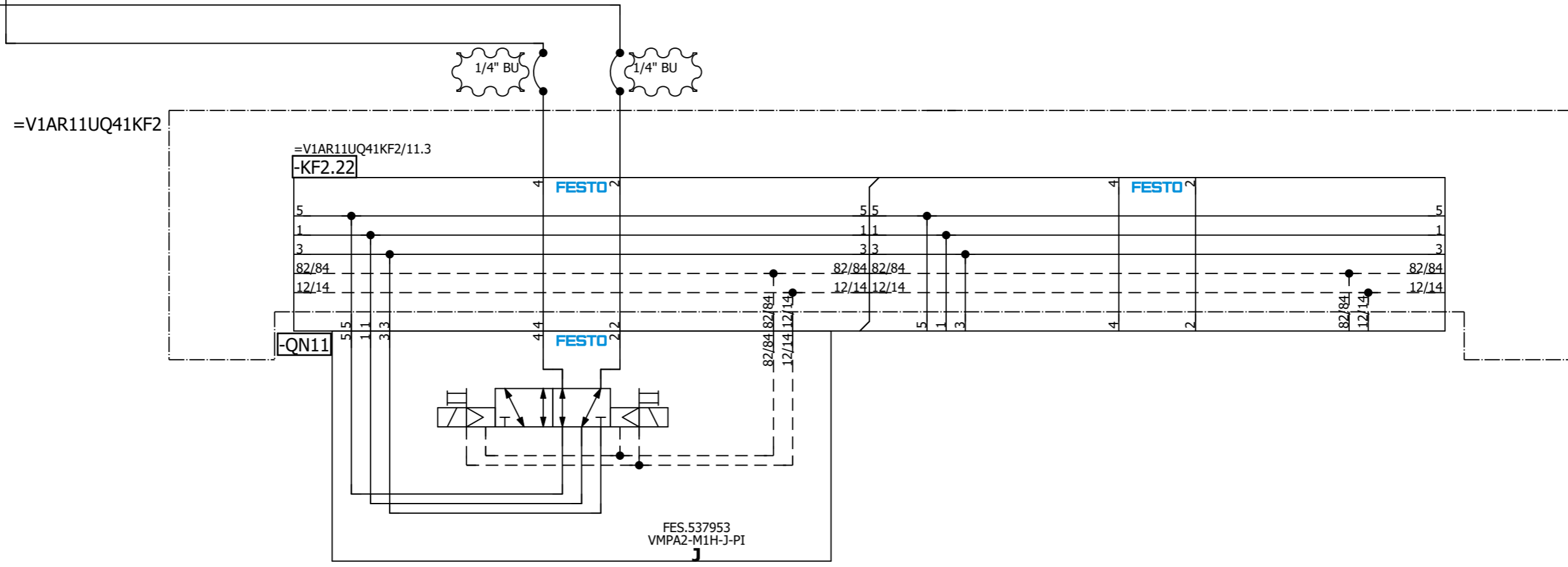
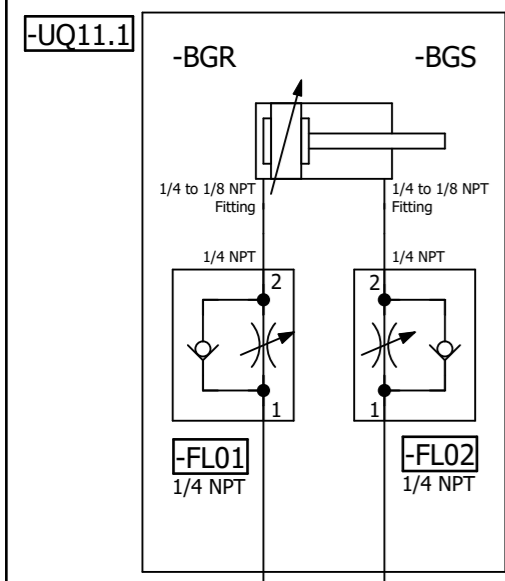

**=V1AR11UQ41  
-UQ11-QN11.1  
L230 Model  
Clamp 1 (RST)**

**=V1AR11UQ41  
-UQ11-QN11.2  
L230 Model  
Clamp 1 (SET)**

=V1AR11UQ41UQ10/1

=V1AR11UQ41UQ12/1

Date: 12/21/2022		Volvo Trucks North America		Valiant TMS		L230 Model Clamp 1		Drawing name: =V1AR11UQ41UQ11		= V1AR11UQ41UQ11	
Ed.: MKLEPADLO		P6700 Underbody Mainline - Cell 2V04		Scale 1:1				Document type: MFS		Project nr: 22-16151	
Appr:		Replacement of						Replaced by		Page 1	

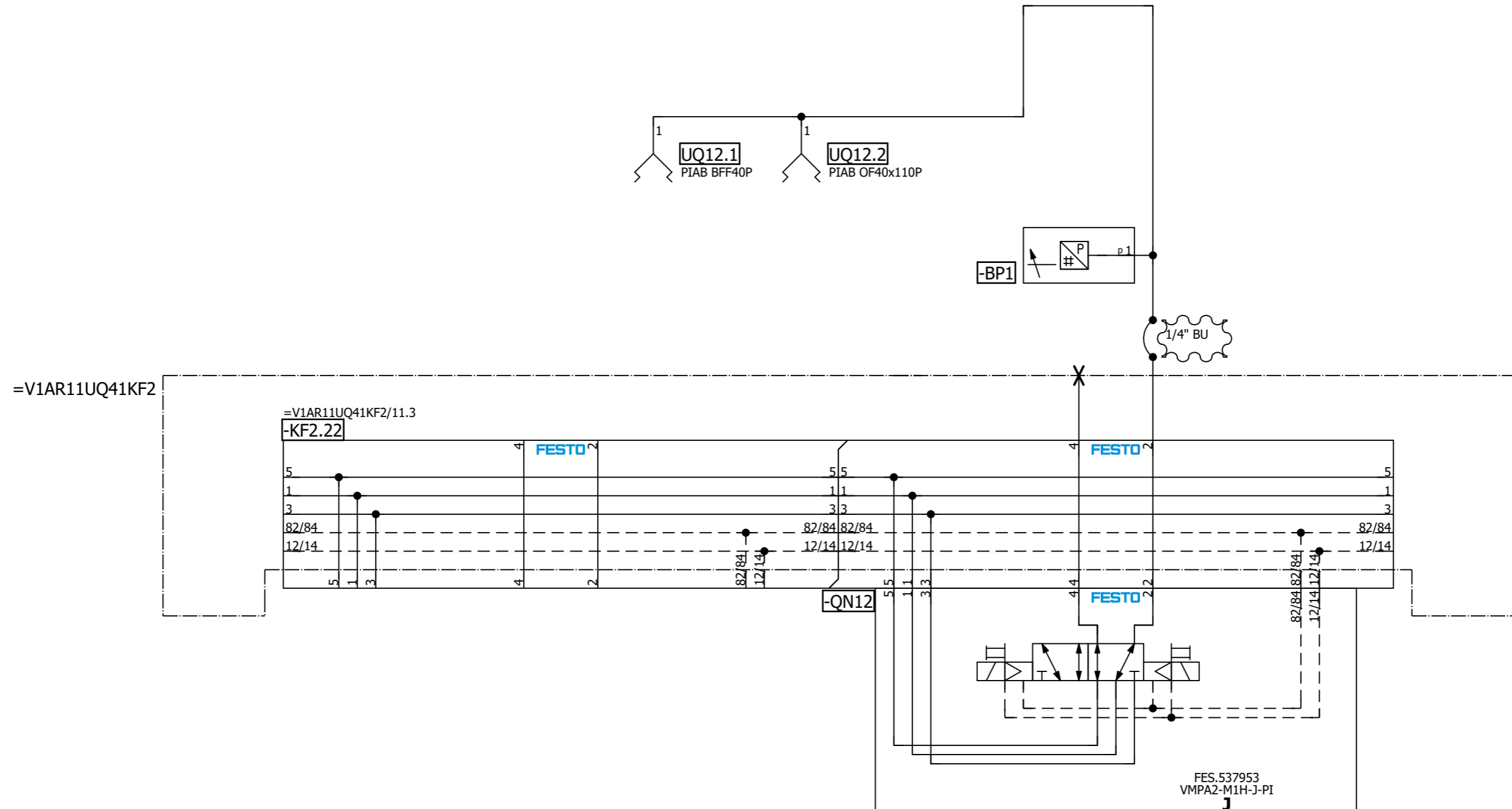

=V1AR11UQ41  
-UQ12-QN12.1  
L230 Model  
Vacuums (RST)

=V1AR11UQ41  
-UQ12-QN12.2  
L230 Model  
Vacuums (SET)

=V1AR11UQ41UQ11/1

=V1AR11UQ41UQ13/1

Date		12/21/2022		Volvo Trucks North America		Valiant TMS		L230 Model Vacuums		Drawing name:		= V1AR11UQ41UQ12	
Ed.		MKLEPADLO		P6700 Underbody Mainline - Cell 2V04		Scale 1:1				Document type:		= V1AR11UQ41	
Appr.				Replacement of		Replaced by				Project nr:		Page	
Original										22-16151		1	
Modification		Date		Name		Original				MFS		227	



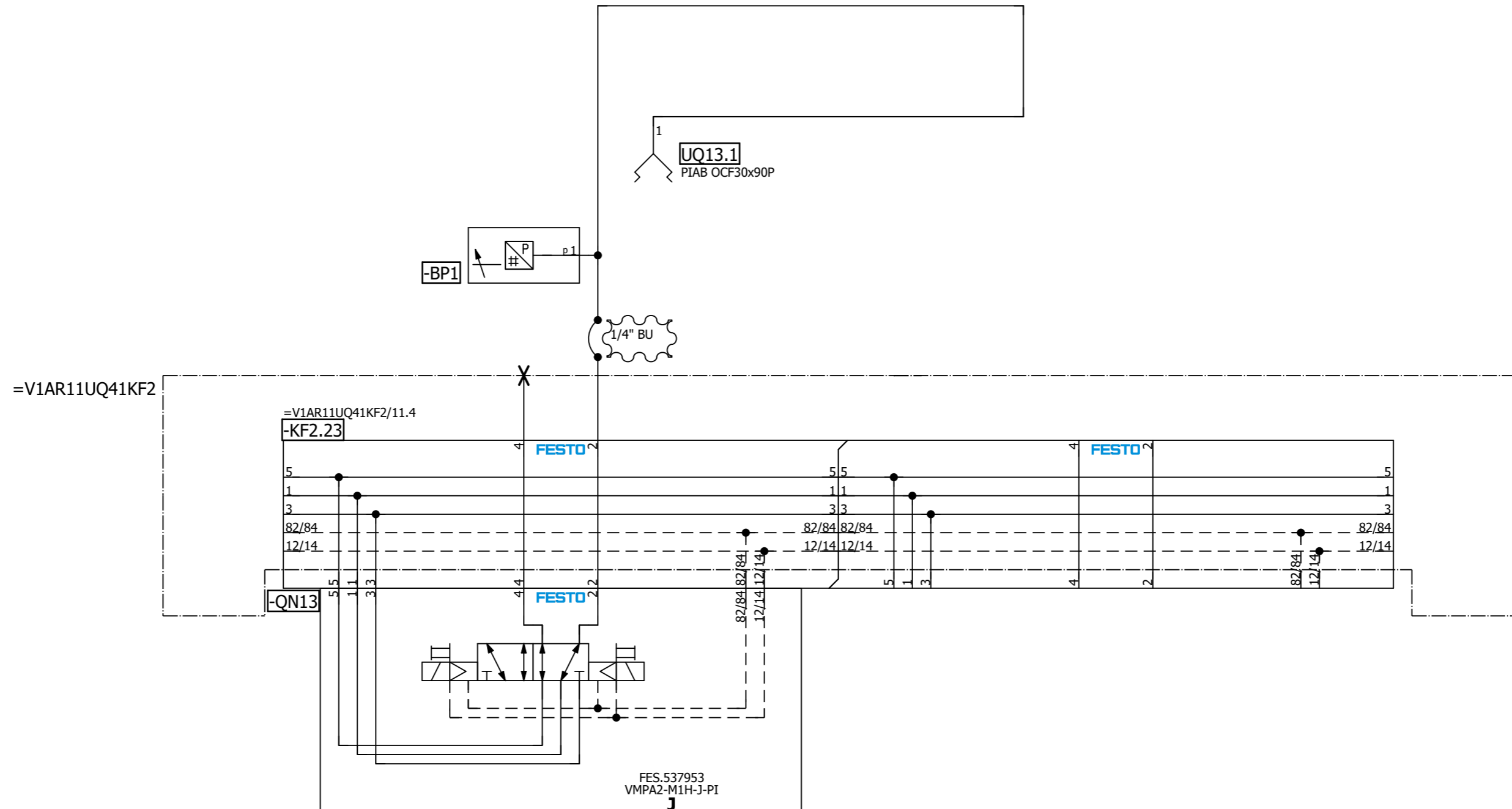

=V1AR11UQ41  
-UQ13-QN13.1  
L230/290/320  
Vacuum (RST)

=V1AR11UQ41  
-UQ13-QN13.2  
L230/290/320  
Vacuum (SET)

=V1AR11UQ41UQ12/1

=V1AR11UQ41UQ14/1

Date		12/21/2022		Volvo Trucks North America		Valiant TMS		L230/290/320 Model Vacuum		Drawing name:		= V1AR11UQ41UQ13	
Ed.		MKLEPADLO		P6700 Underbody Mainline - Cell 2V04		Scale 1:1				Document type:		= 2V04&MFS-PNEU	
Appr.				Replacement of		Replaced by				Project nr:		+ V1AR11UQ41	
Modification		Date		Name		Original				MFS		Page 1	
										22-16151		227	

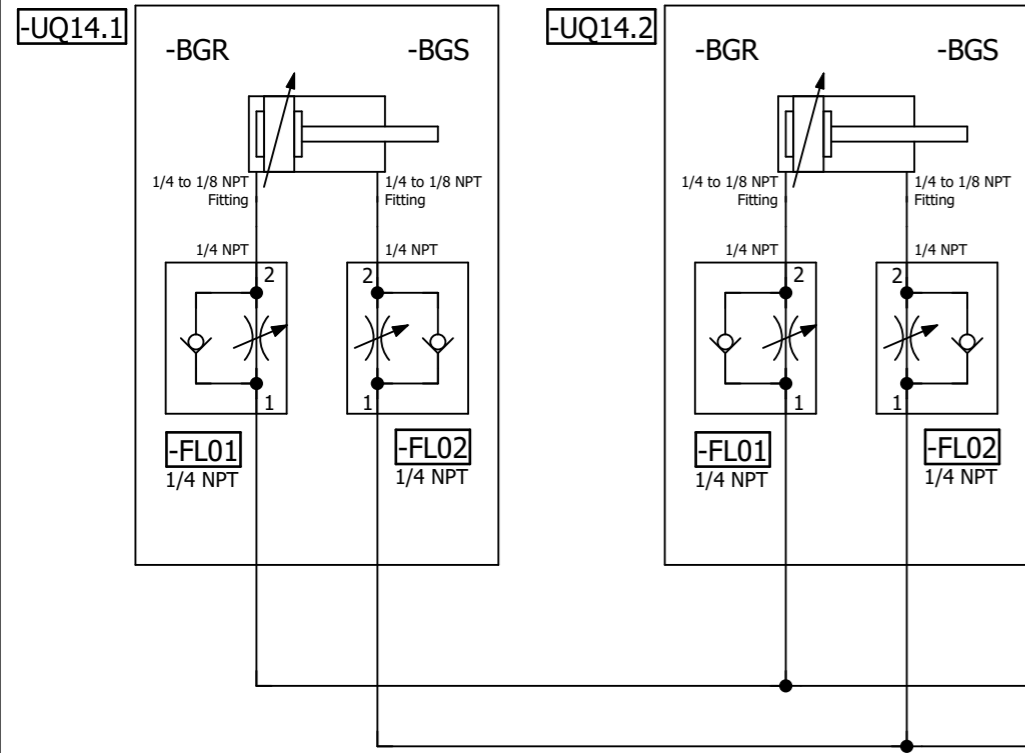

=V1AR11UQ41KF2

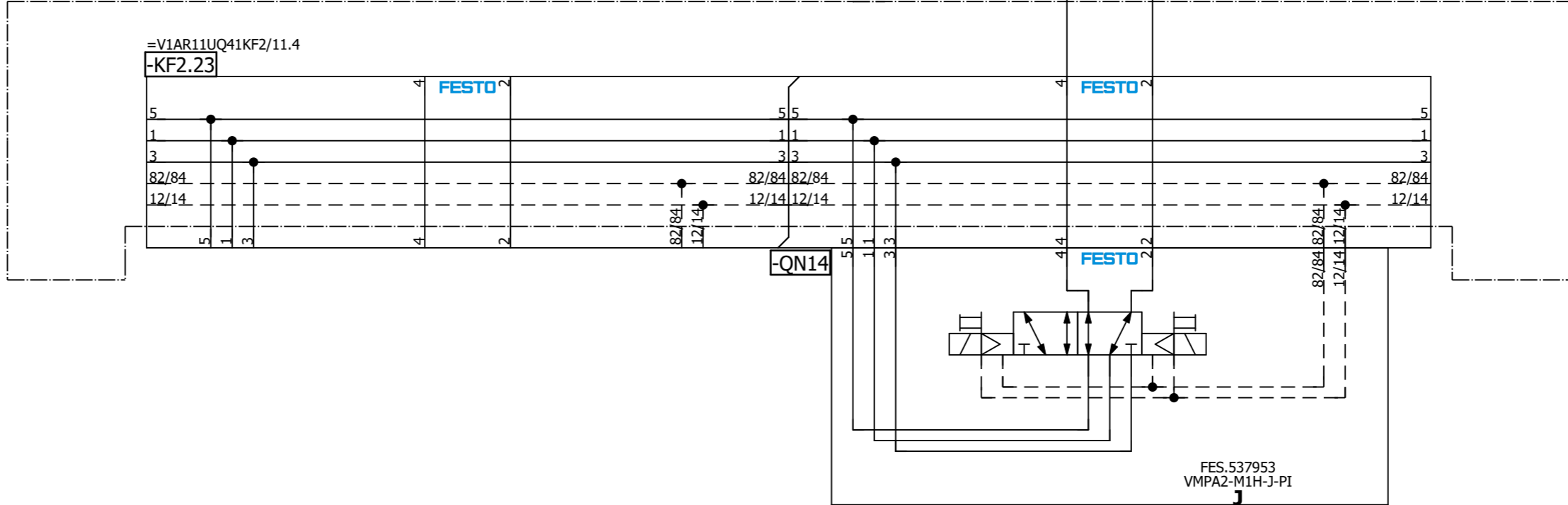

=V1AR11UQ41  
-UQ14-QN14.1  
L230 Model  
Clamps 2 (RST)

=V1AR11UQ41  
-UQ14-QN14.2  
L230 Model  
Clamps 2 (SET)

=V1AR11UQ41UQ13/1

=V1AR11UQ41UQ15/1

		Date	12/21/2022	Volvo Trucks North America		Valiant TMS		L230 Model Clamps 2		Drawing name: =2V04&MFS-PNEU		= V1AR11UQ41UQ14 + V1AR11UQ41	
		Ed.	MKLEPADLO	P6700 Underbody Mainline - Cell 2V04		Scale 1:1				Document type: MFS		Project nr: 22-16151	
Modification	Date	Name	Original	Replacement of	Replaced by							Page	1
													227



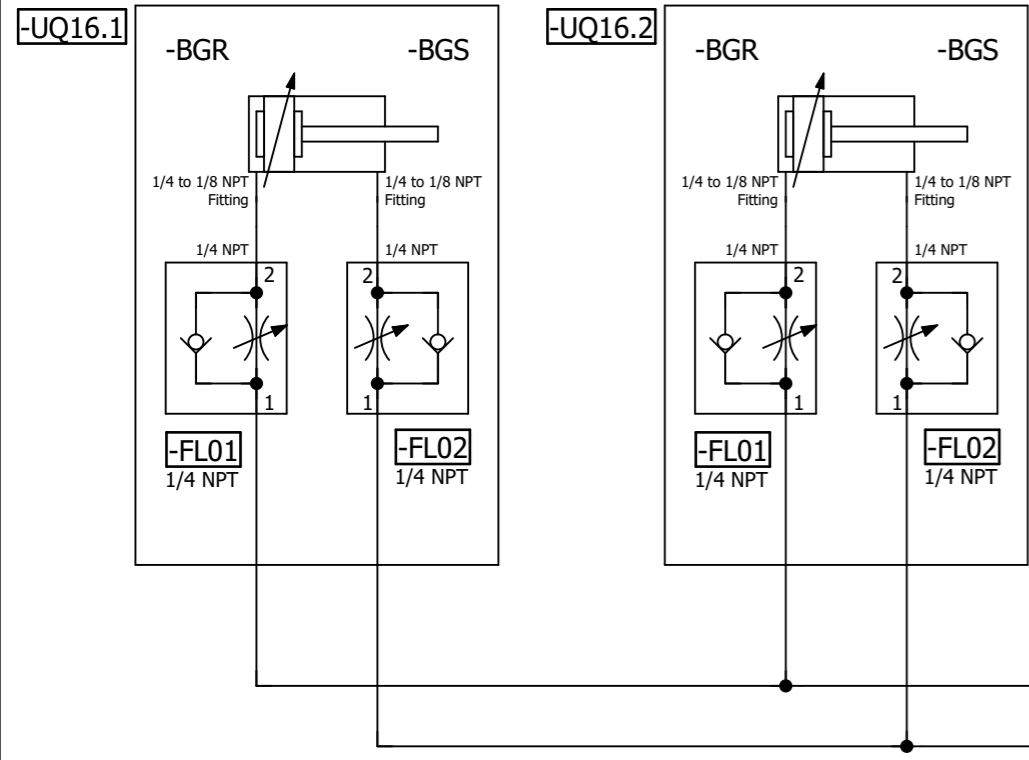

=V1AR11UQ41KF2

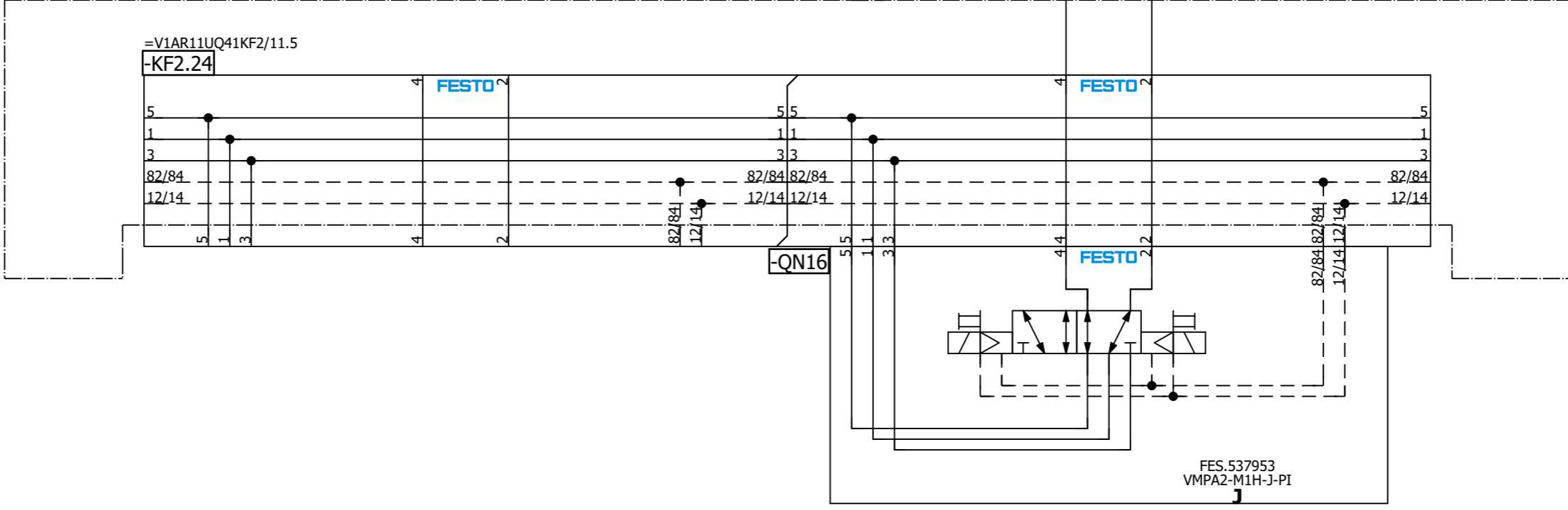

=V1AR11UQ41  
-UQ16-QN16.1  
L290/320 Model  
Clamps (RST)

=V1AR11UQ41  
-UQ16-QN16.2  
L290/320 Model  
Clamps (SET)

=V1AR11UQ41UQ15/1

=V1AR11UQ41UQ17/1



**-UQ17.1**

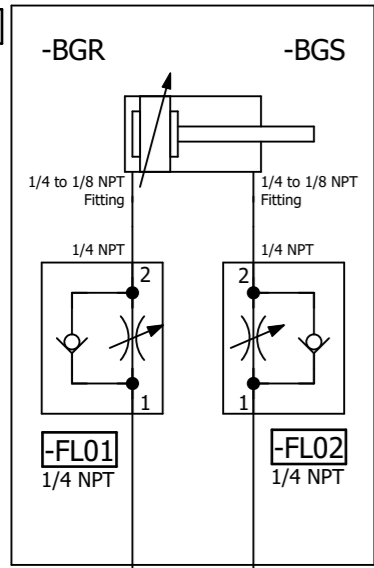

=V1AR11UQ41KF3

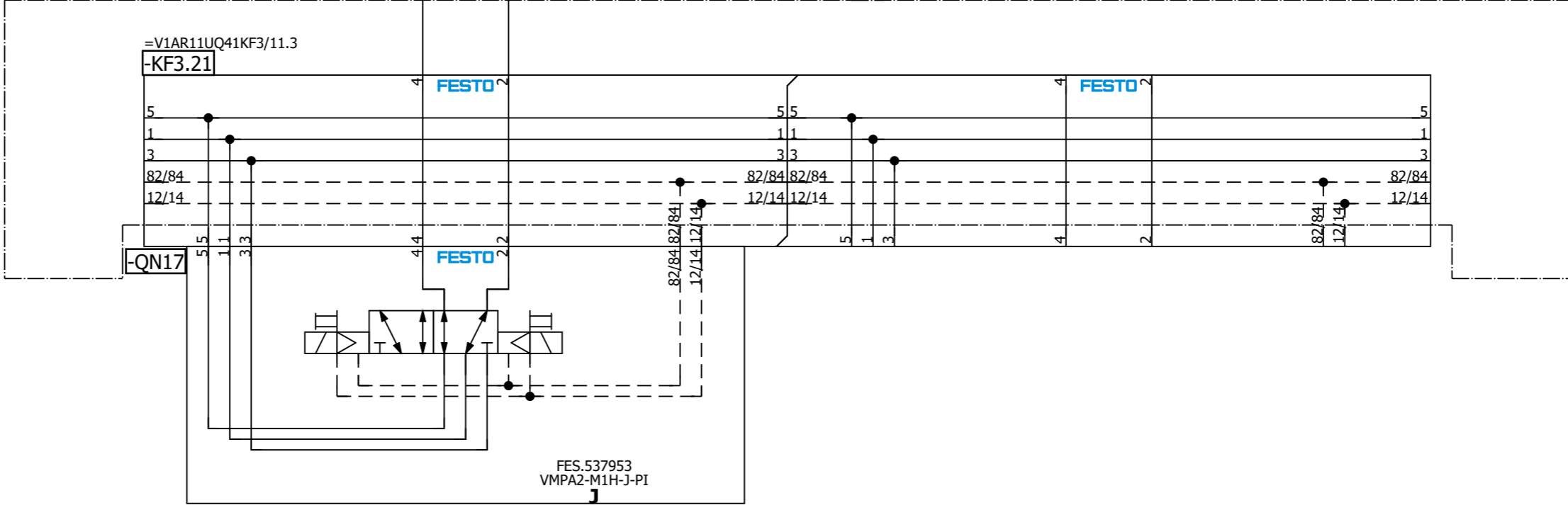

**=V1AR11UQ41  
-UQ17-QN17.1  
L290 Model  
Clamp 2 (RST)**

**=V1AR11UQ41  
-UQ17-QN17.2  
L290 Model  
Clamp 2 (SET)**

=V1AR11UQ41UQ16/1

=V1AR11UQ41UQ18/1

Date: 12/21/2022		Volvo Trucks North America		Valiant TMS		L290 Model Clamp 2		Drawing name: =2V04&MFS-PNEU		= V1AR11UQ41UQ17	
Ed.: MKLEPADLO		P6700 Underbody Mainline - Cell 2V04		Scale 1:1		Document type: MFS		Project nr: 22-16151		+ V1AR11UQ41	
Appr:		Replacement of								Replaced by	
Modification	Date	Name	Original							Page 227	



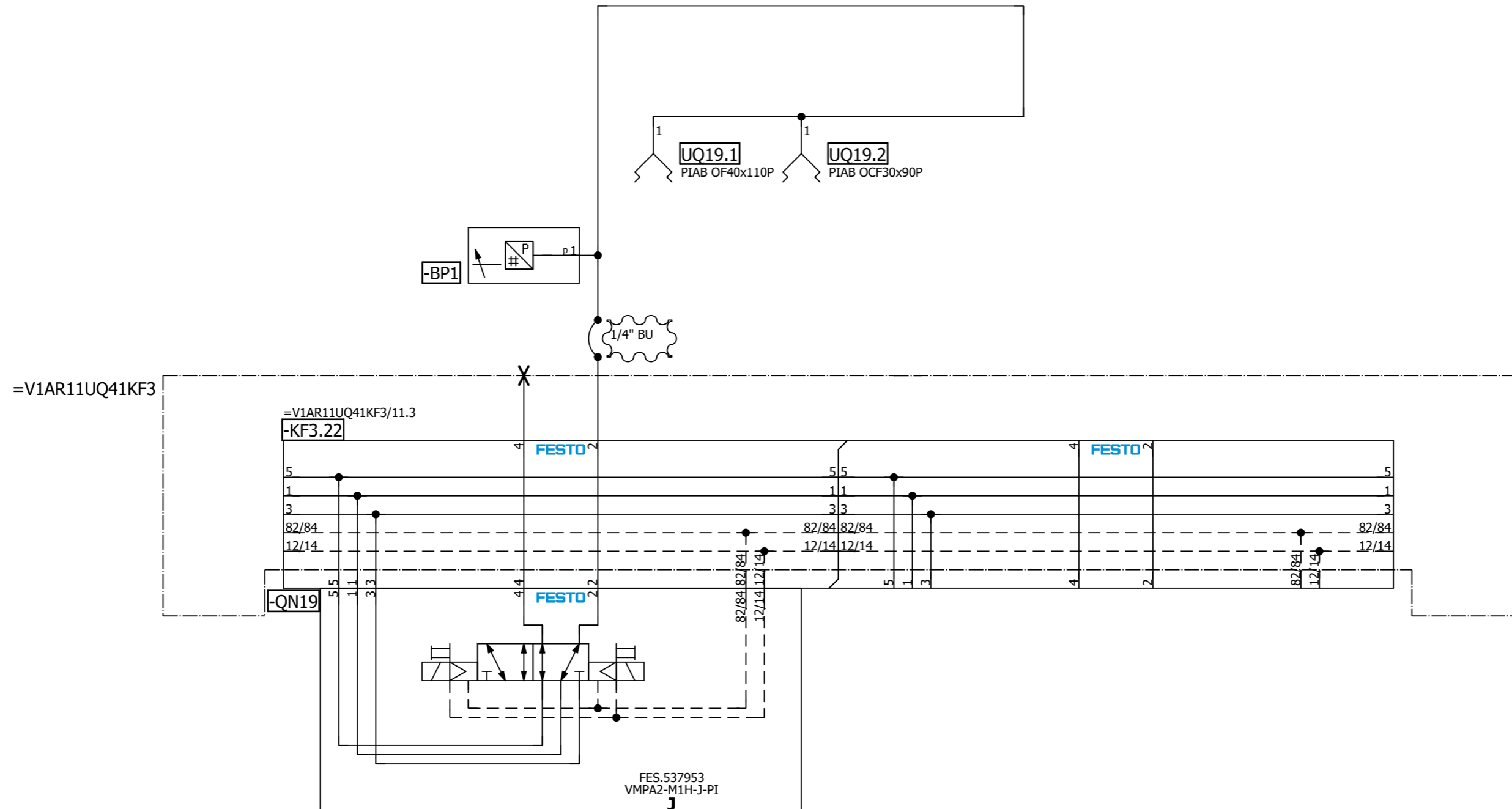

=V1AR11UQ41  
-UQ19-QN19.1  
L290/320 Model  
Vacuums (RST)

=V1AR11UQ41  
-UQ19-QN19.2  
L290/320 Model  
Vacuums (SET)

=V1AR11UQ41UQ18/1

=V1AR11UQ41UQ20/1

Date		12/21/2022		Volvo Trucks North America		Valiant TMS		L290/320 Model Vacuums		Drawing name:		= V1AR11UQ41UQ19	
Ed.		MKLEPADLO		P6700 Underbody Mainline - Cell 2V04		Scale 1:1				Document type:		= 2V04&MFS-PNEU	
Appr.				Replacement of		Replaced by				Project nr:		+ V1AR11UQ41	
Modification		Date		Name		Original				MFS		Page 1	
										22-16151		227	

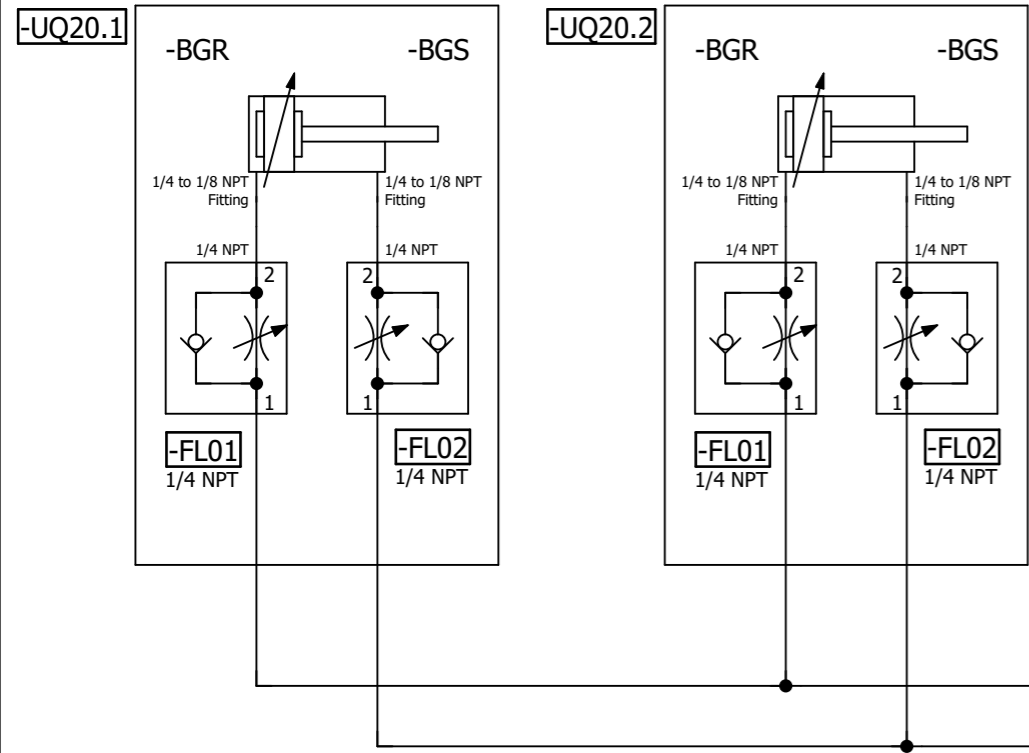

=V1AR11UQ41KF3

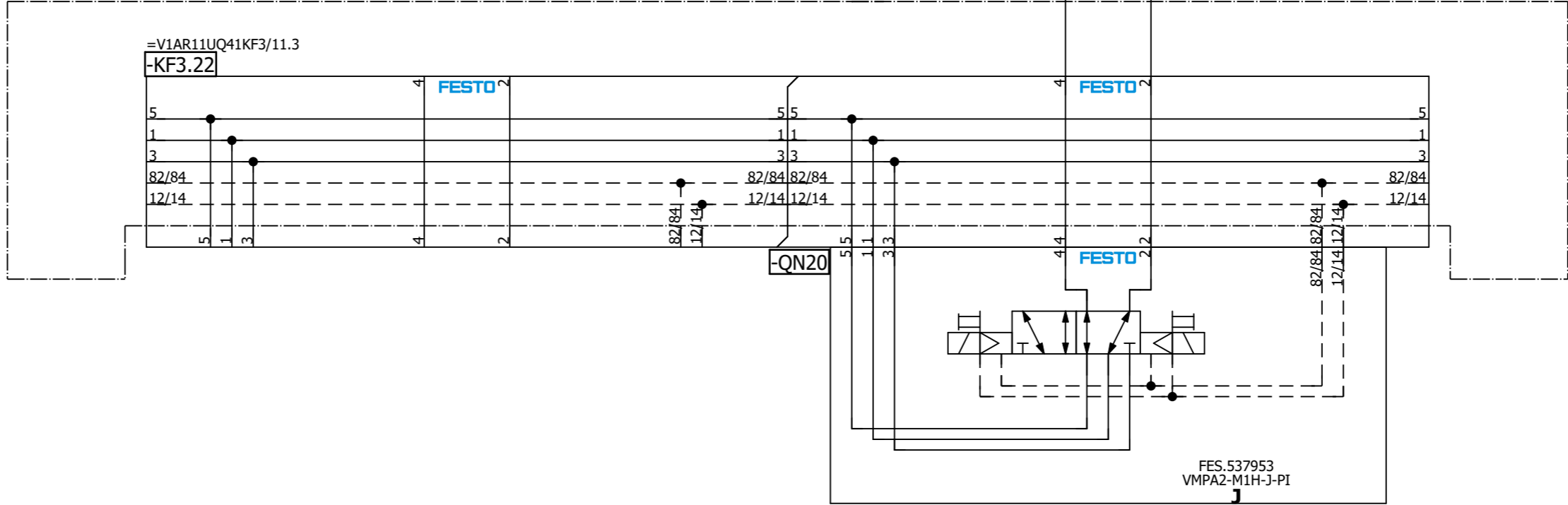

=V1AR11UQ41  
-UQ20-QN20.1  
L290 Model  
Clamps 3 (RST)

=V1AR11UQ41  
-UQ20-QN20.2  
L290 Model  
Clamps 3 (SET)

=V1AR11UQ41UQ19/1

=V1AR11UQ41UQ21/1

		Date	12/21/2022	Volvo Trucks North America		Valiant TMS		L290 Model Clamps 3		Drawing name: =2V04&MFS-PNEU		= V1AR11UQ41UQ20 + V1AR11UQ41	
		Ed.	MKLEPADLO	P6700 Underbody Mainline - Cell 2V04		Scale 1:1				Document type: MFS		Project nr: 22-16151	
Modification	Date	Name	Original	Replacement of	Replaced by							Page	1
													227

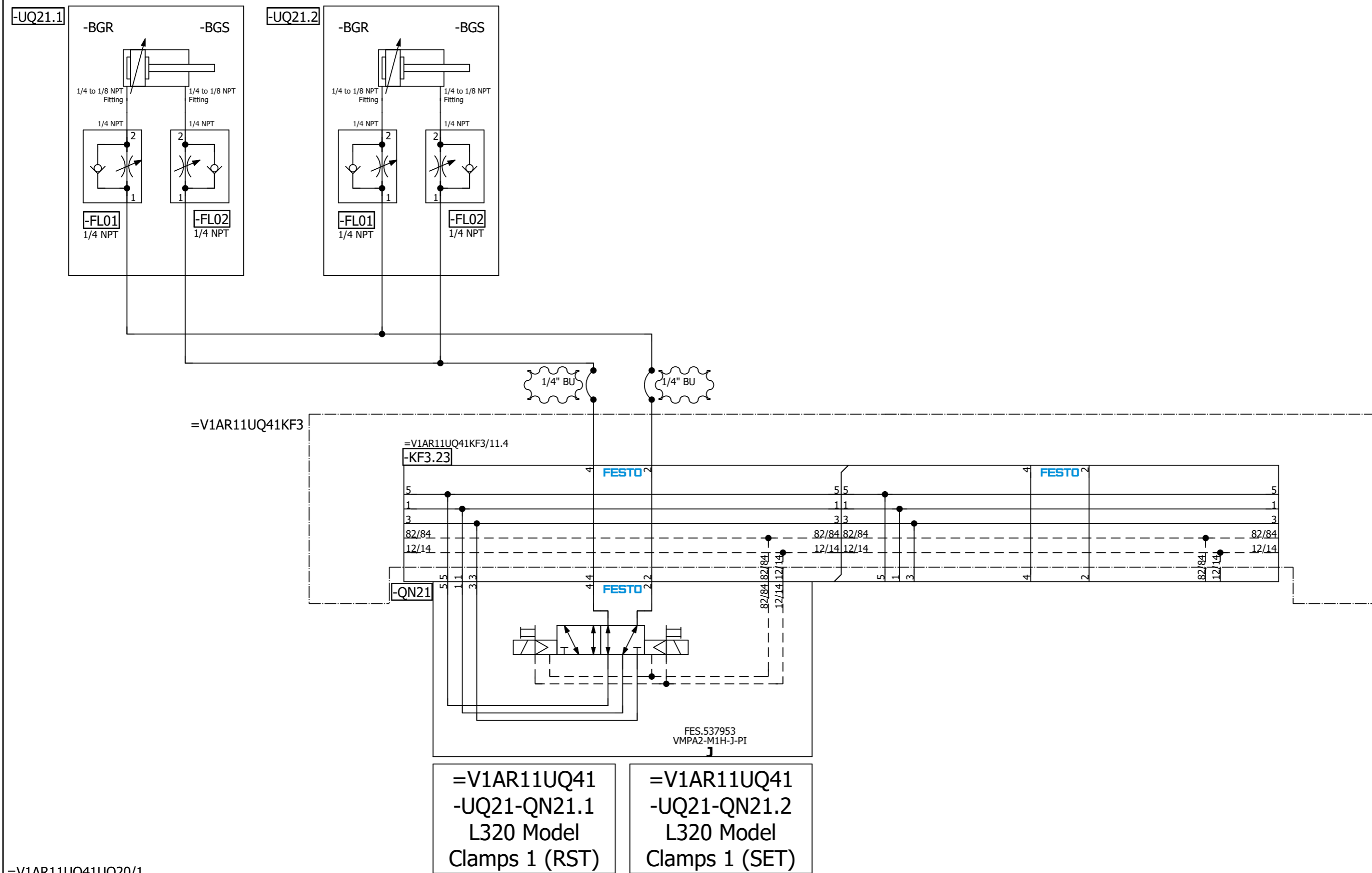

**=V1AR11UQ41**  
**-UQ21-QN21.1**  
**L320 Model**  
**Clamps 1 (RST)**

**=V1AR11UQ41**  
**-UQ21-QN21.2**  
**L320 Model**  
**Clamps 1 (SET)**

=V1AR11UQ41UQ20/1

=V1AR11UQ41UQ22/1

Date: 12/21/2022		Volvo Trucks North America		Valiant TMS		L320 Model Clamps 1		Drawing name: =V1AR11UQ41UQ21		= V1AR11UQ41UQ21	
Ed.: MKLEPADLO		P6700 Underbody Mainline - Cell 2V04		Scale 1:1				Document type: MFS		Project nr: 22-16151	
Appr:		Replacement of		Replaced by				Page: 1		227	

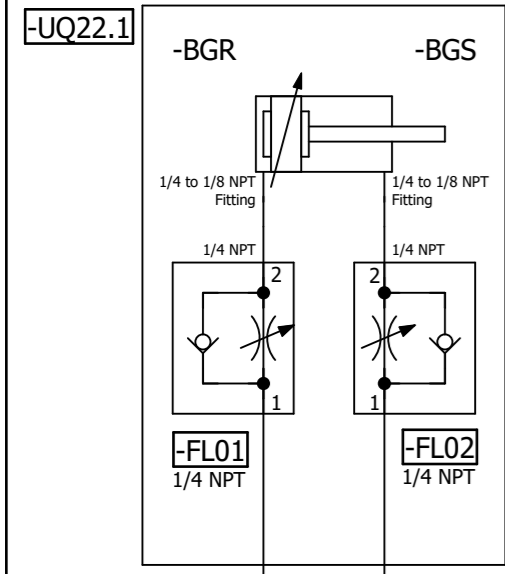

=V1AR11UQ41KF3

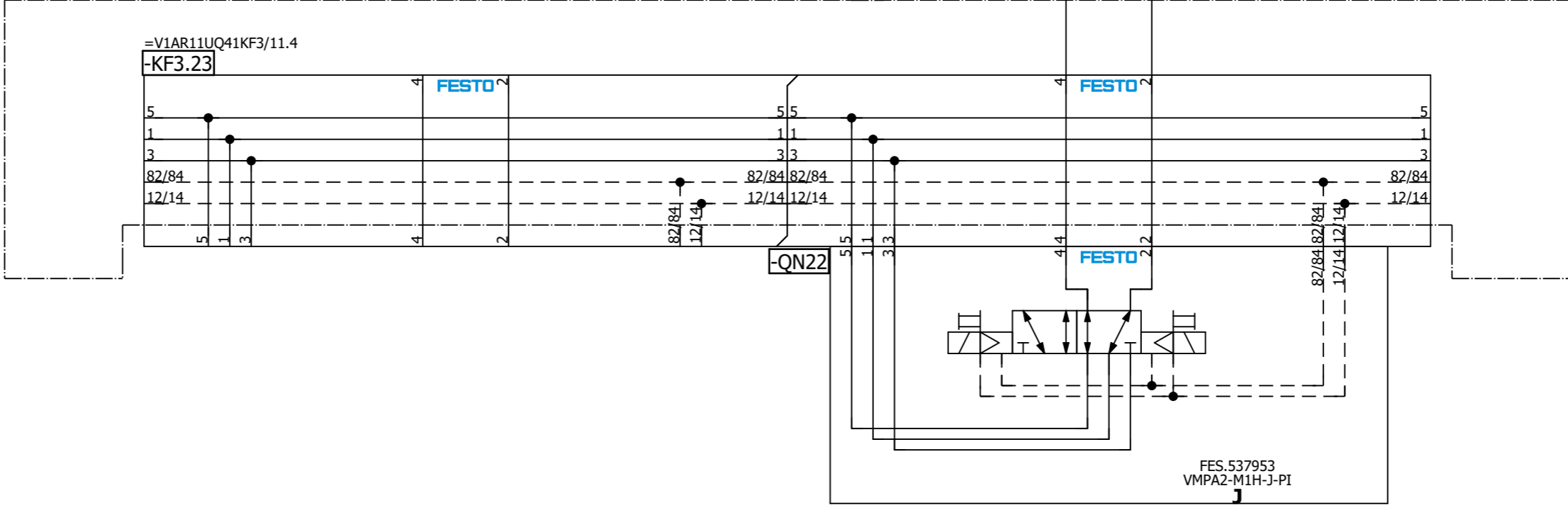

=V1AR11UQ41  
-UQ22-QN22.1  
L320 Model  
Clamp 2 (RST)

=V1AR11UQ41  
-UQ22-QN22.2  
L320 Model  
Clamp 2 (SET)

=V1AR11UQ41UQ21/1

=V1AR11UQ41UQ23/1

			Date	12/21/2022	Volvo Trucks North America		Valiant TMS	L320 Model Clamp 2	Drawing name:	= V1AR11UQ41UQ22	
			Ed.	MKLEPADLO	P6700 Underbody Mainline - Cell 2V04				= 2V04&MFS-PNEU	= V1AR11UQ41	
			Appr.		Replacement of	Replaced by	Scale 1:1		Document type:	Project nr:	Page
Modification	Date	Name	Original						MFS	22-16151	1
											227



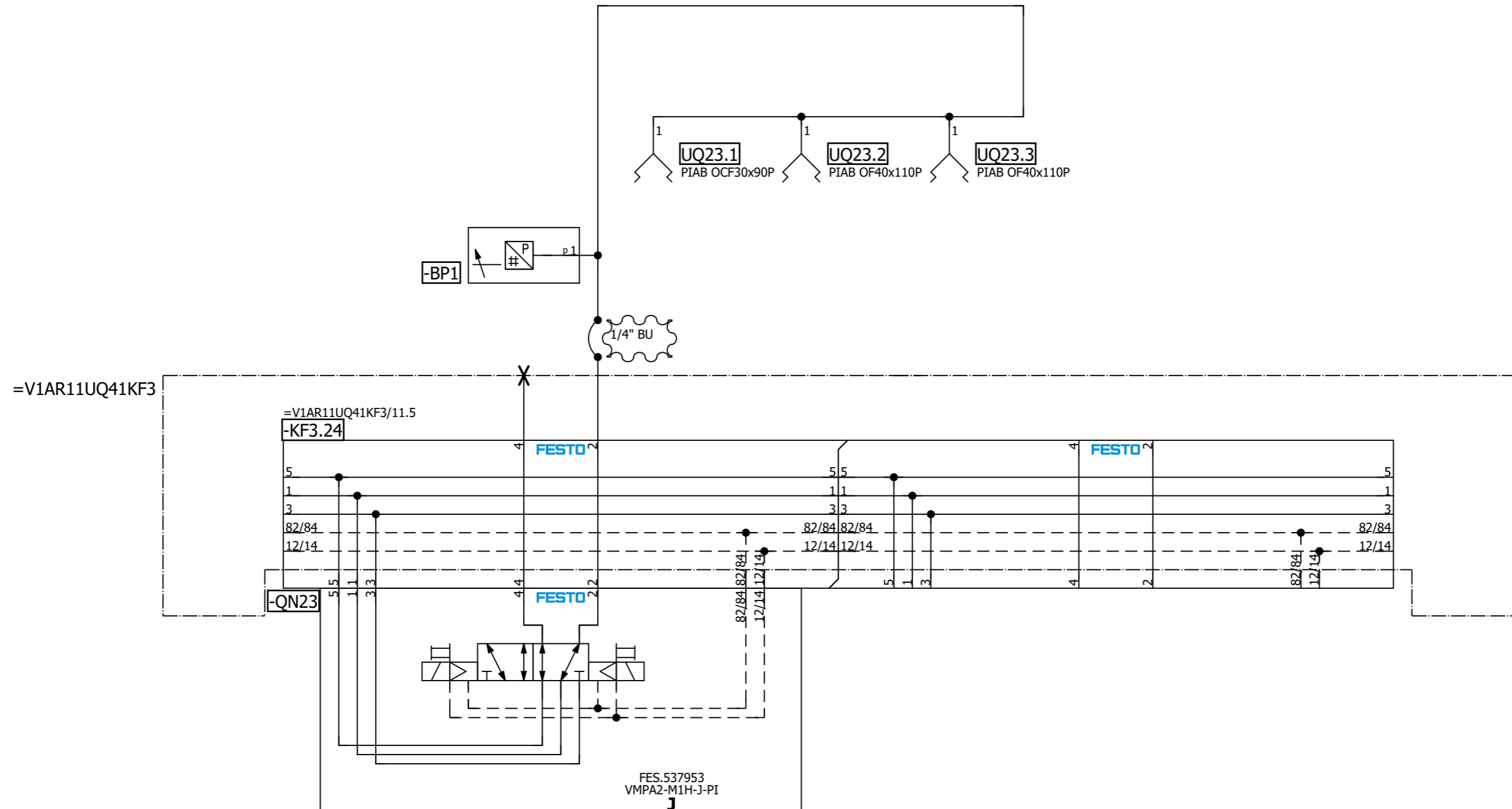

=V1AR11UQ41  
-UQ23-QN23.1  
L320 Model  
Vacuums (RST)

=V1AR11UQ41  
-UQ23-QN23.2  
L320 Model  
Vacuums (SET)

=V1AR11UQ41UQ22/1

=V1AR11UQ41UQ24/1

Date		12/21/2022		Volvo Trucks North America		Valiant TMS		L320 Model Vacuums		Drawing name:		= V1AR11UQ41UQ23	
Ed.		MKLEPADLO		P6700 Underbody Mainline - Cell 2V04		Scale 1:1				Document type:		= 2V04&MFS-PNEU	
Appr.				Replacement of		Replaced by				Project nr:		+ V1AR11UQ41	
Modification		Date		Name		Original				MFS		Page 1	
										22-16151		227	

-UQ24.1

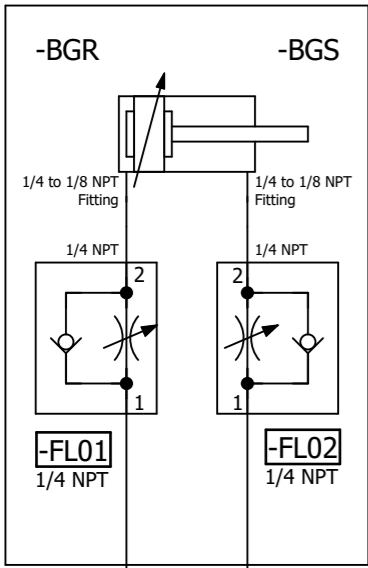

-UQ24.2

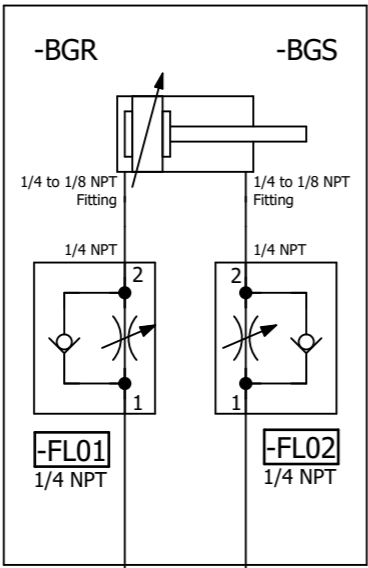

=V1AR11UQ41KF3

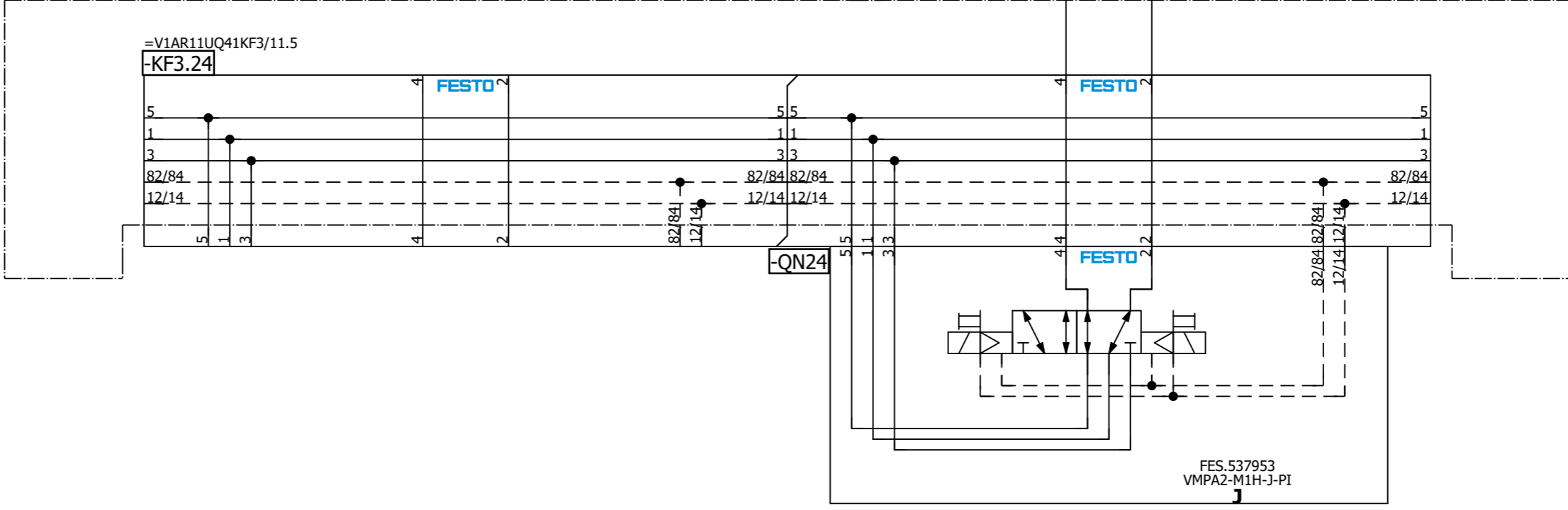

=V1AR11UQ41  
-UQ24-QN24.1  
L320 Model  
Clamps 3 (RST)

=V1AR11UQ41  
-UQ24-QN24.2  
L320 Model  
Clamps 3 (SET)

=V1AR12UQ41KF1+.AR12UQ41/1

=V1AR11UQ41UQ23/1

Date		12/21/2022		Volvo Trucks North America		Valiant TMS		L320 Model Clamps 3		Drawing name:		= V1AR11UQ41UQ24	
Ed.		MKLEPADLO		P6700 Underbody Mainline - Cell 2V04		Scale 1:1				Document type:		= V1AR11UQ41	
Appr.				Replacement of		Replaced by				Project nr:		Page	
Original										22-16151		1	
Modification		Date		Name		Original				MFS		227	



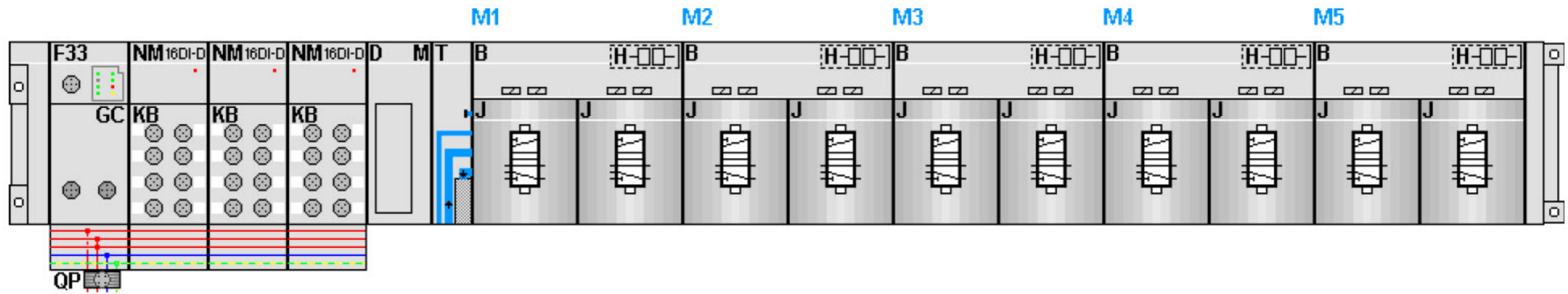

KF1.0

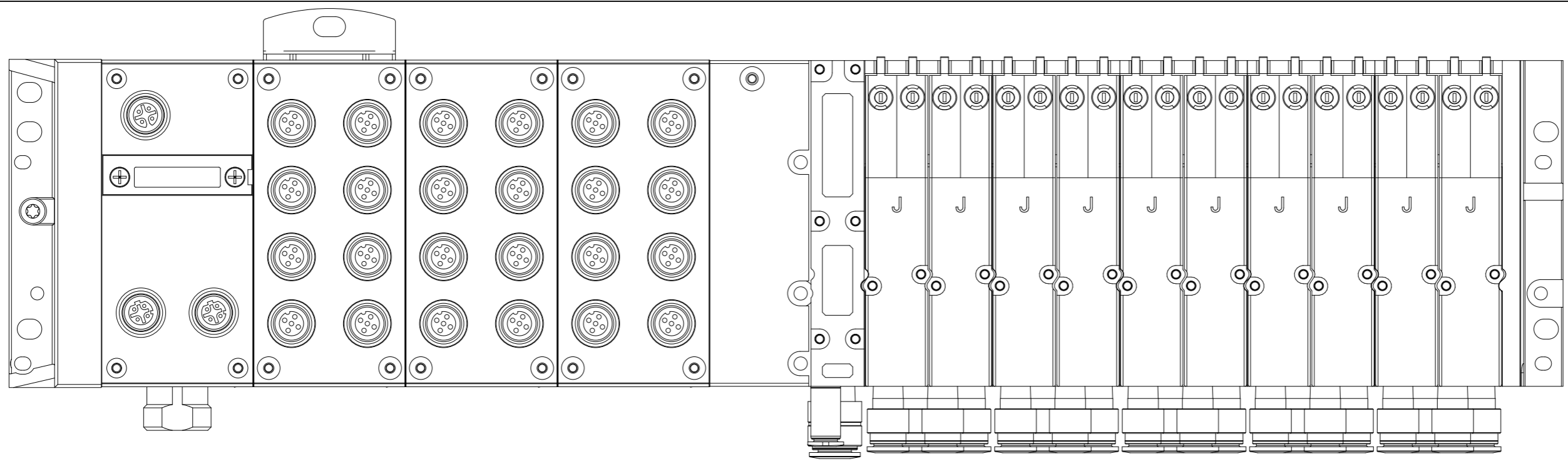

Date		12/21/2022	Volvo Trucks North America		Valiant TMS	AIR SUPPLY	Drawing name:		= V1AR12UQ41KF1
Ed.		MKLEPADLO	P6700 Underbody Mainline - Cell 2V04				= 2V04&MFS-PNEU		+ V1AR12UQ41
Appr			Replacement of		Scale 1:1		Document type:	Project nr:	Page
Modification	Date	Name	Original	Replaced by			MFS	22-16151	5

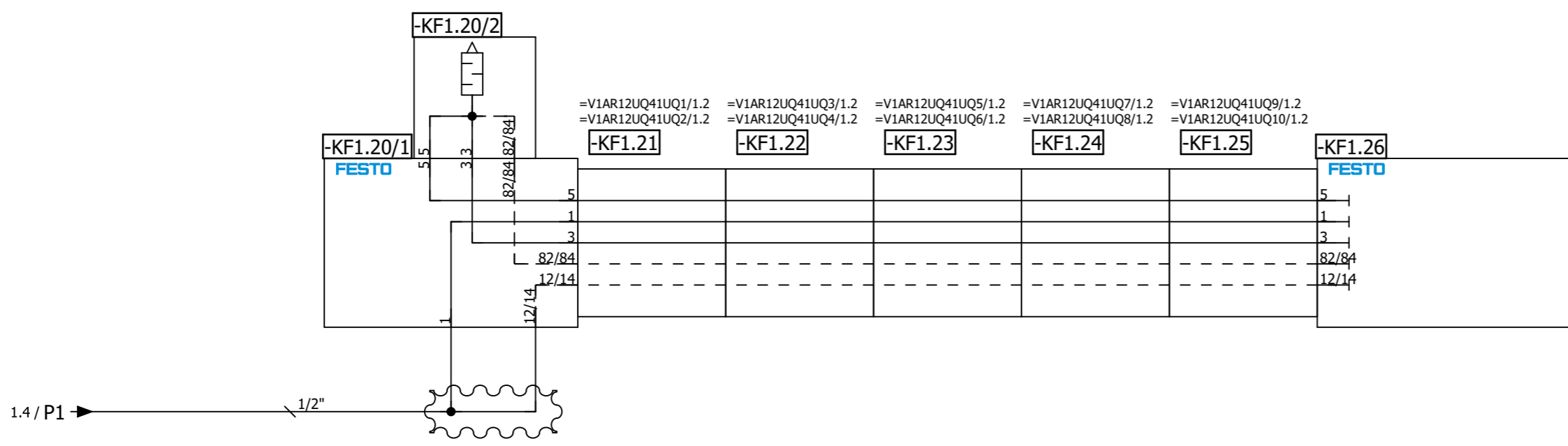
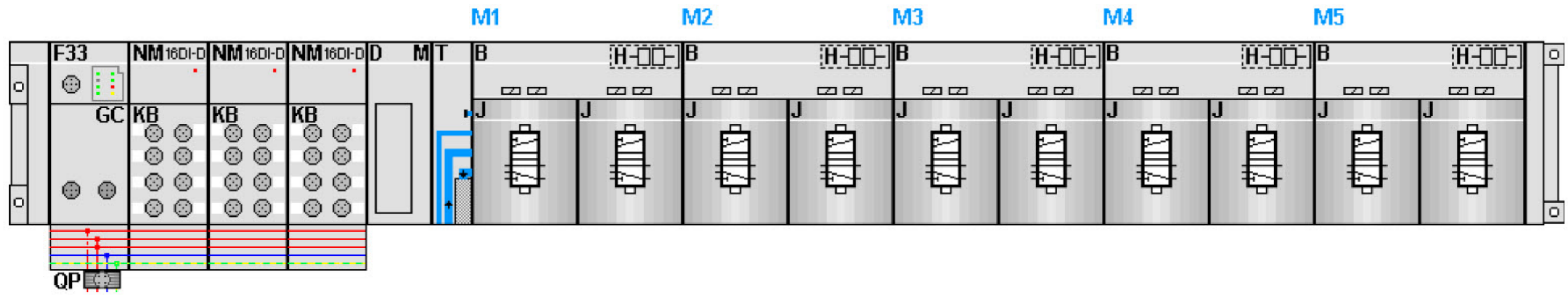

Date		12/21/2022	Volvo Trucks North America		Valiant TMS	AIR SUPPLY	Drawing name:		= V1AR12UQ41KF1
Ed.		MKLEPADLO	P6700 Underbody Mainline - Cell 2V04				=2V04&MFS-PNEU		+ V1AR12UQ41
Appr			Replacement of		Scale 1:1		Document type:	Project nr:	Page
Modification	Date	Name	Original	Replaced by			MFS	22-16151	11



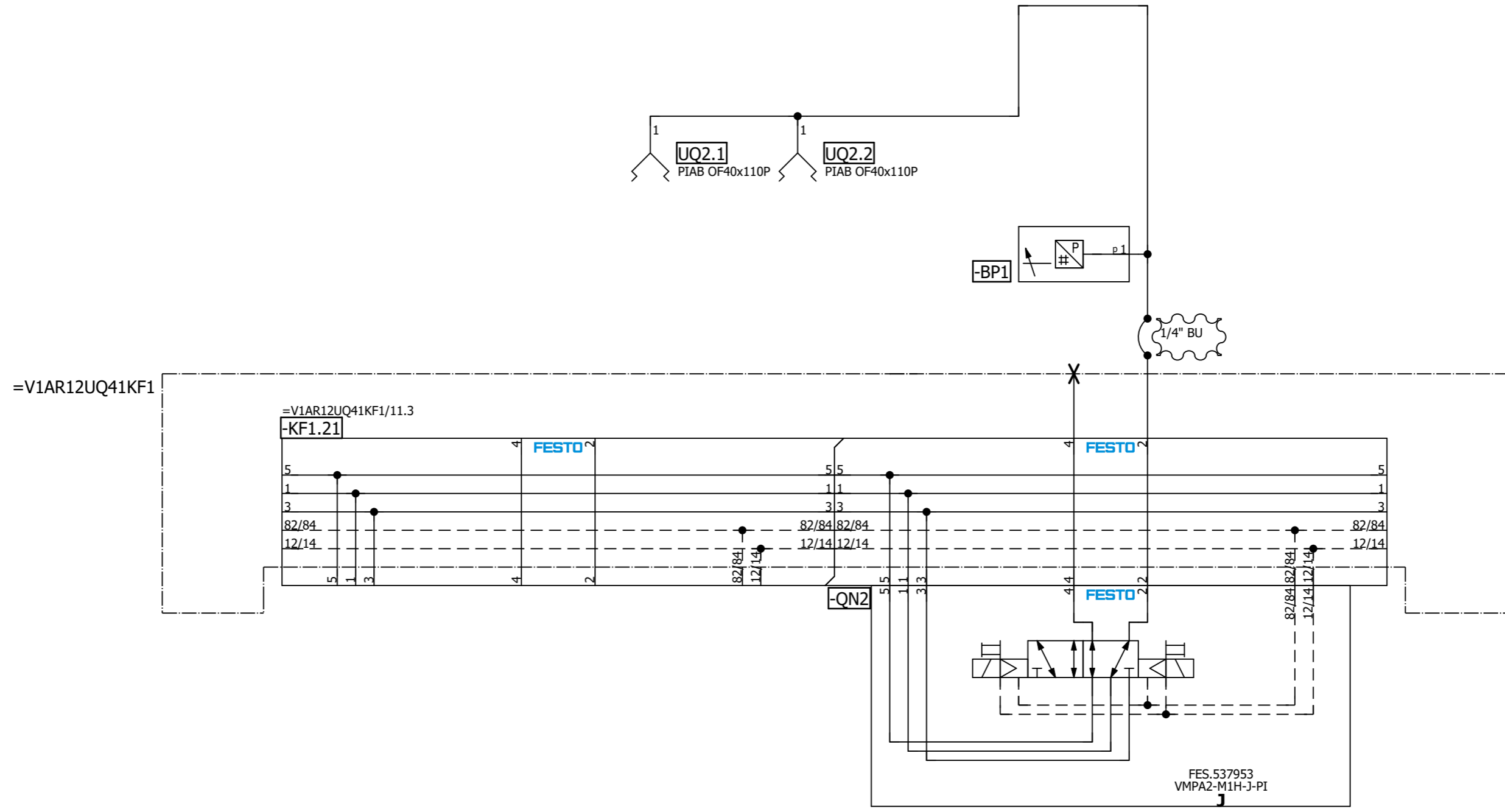

=V1AR12UQ41KF1

=V1AR12UQ41KF1/11.3

-KF1.21

=V1AR12UQ41  
-UQ2-QN2.1  
L230/320 Model  
Vacuums (RST)

=V1AR12UQ41  
-UQ2-QN2.2  
L230/320 Model  
Vacuums (SET)

=V1AR12UQ41UQ1/1

=V1AR12UQ41UQ3/1

Date		12/21/2022		Volvo Trucks North America		Valiant TMS		L230/320 Model Vacuums		Drawing name:		= V1AR12UQ41UQ2	
Ed.		MKLEPADLO		P6700 Underbody Mainline - Cell 2V04		Scale 1:1				=2V04&MFS-PNEU		+ V1AR12UQ41	
Appr.				Replacement of		Replaced by				Document type:		Project nr:	
Original										MFS		22-16151	
Modification		Date		Name		Original						Page	
												1	
												227	





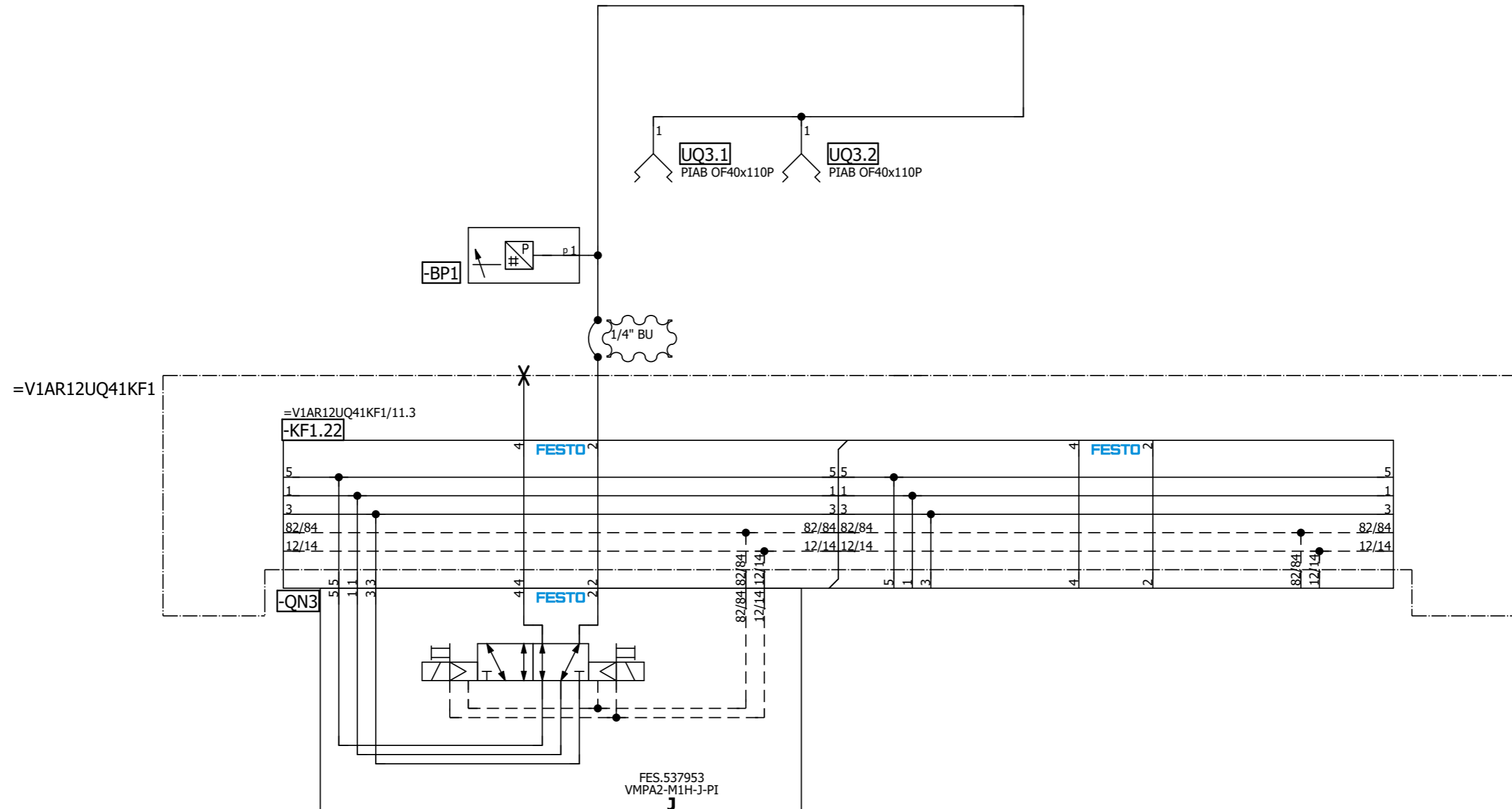

=V1AR12UQ41  
-UQ3-QN3.1  
L290 Model  
Vacuums (RST)

=V1AR12UQ41  
-UQ3-QN3.2  
L290 Model  
Vacuums (SET)

=V1AR12UQ41UQ2/1

=V1AR12UQ41UQ4/1

Date		12/21/2022		Volvo Trucks North America		Valiant TMS		L290 Model Vacuums		Drawing name:		= V1AR12UQ41UQ3	
Ed.		MKLEPADLO		P6700 Underbody Mainline - Cell 2V04		Scale 1:1				Document type:		= 2V04&MFS-PNEU	
Appr.				Replacement of		Replaced by				Project nr:		+ V1AR12UQ41	
Modification		Date		Name		Original				MFS		22-16151	
											Page	1	
												227	



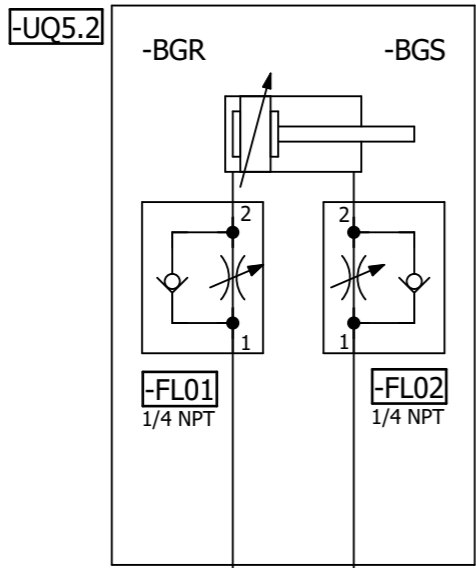
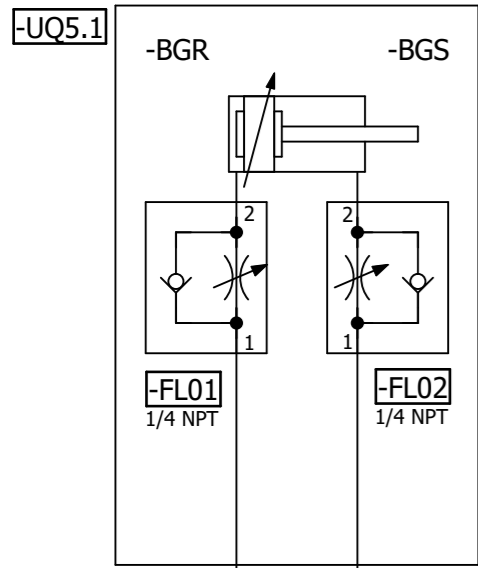

=V1AR12UQ41KF1

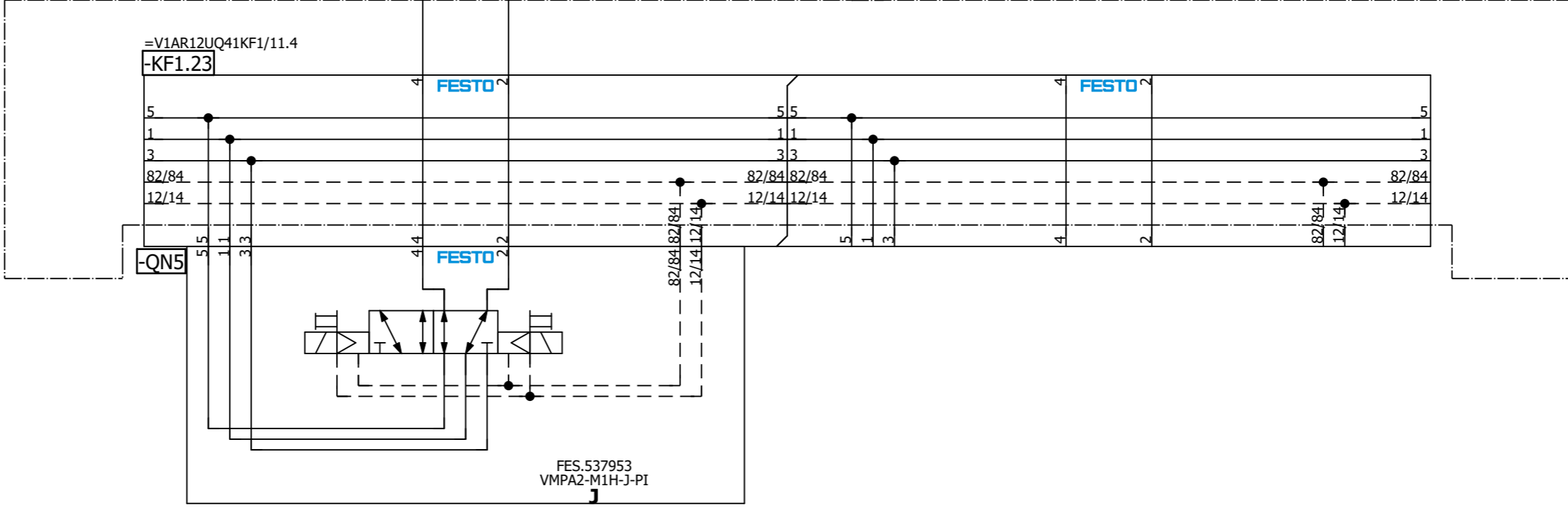

=V1AR12UQ41  
-UQ5-QN5.1  
Common  
Clamps (RST)

=V1AR12UQ41  
-UQ5-QN5.2  
Common  
Clamps (SET)

=V1AR12UQ41UQ4/1

=V1AR12UQ41UQ6/1

Date		12/21/2022	Volvo Trucks North America		Valiant TMS	Common Clamps	Drawing name:		= V1AR12UQ41UQ5
Ed.		MKLEPADLO	P6700 Underbody Mainline - Cell 2V04				=2V04&MFS-PNEU		+ V1AR12UQ41
Appr			Replacement of		Scale 1:1		Document type:		MFS
Original			Replaced by				Project nr:		22-16151
Modification	Date	Name	Original				Page		1
									227

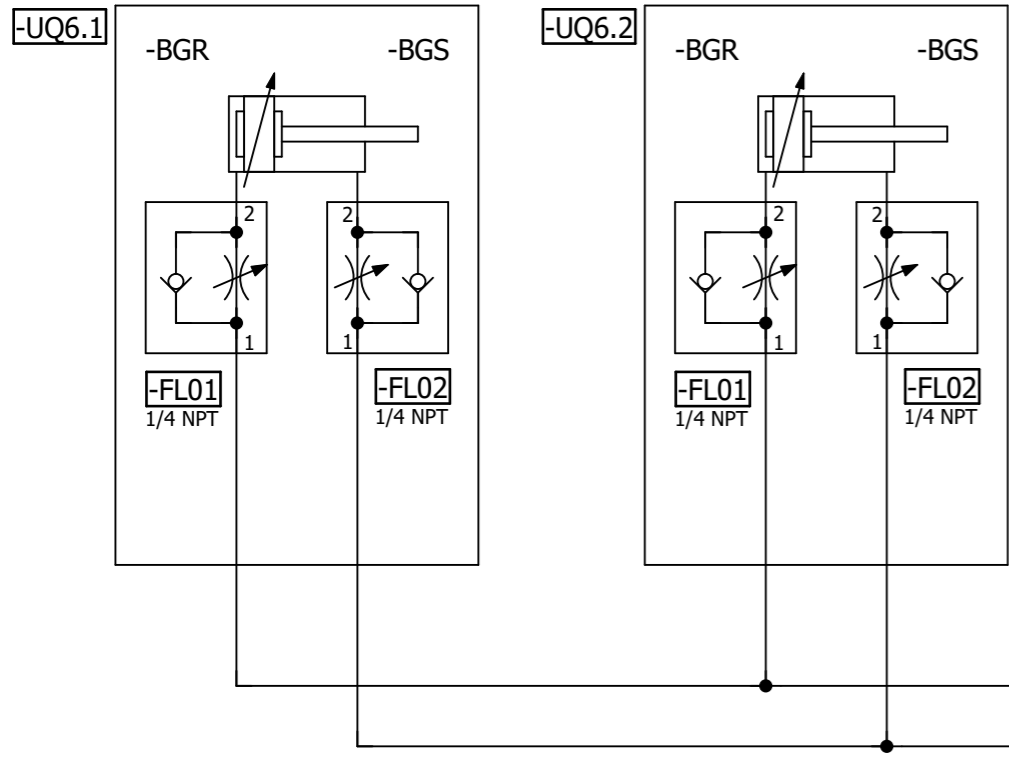

=V1AR12UQ41KF1

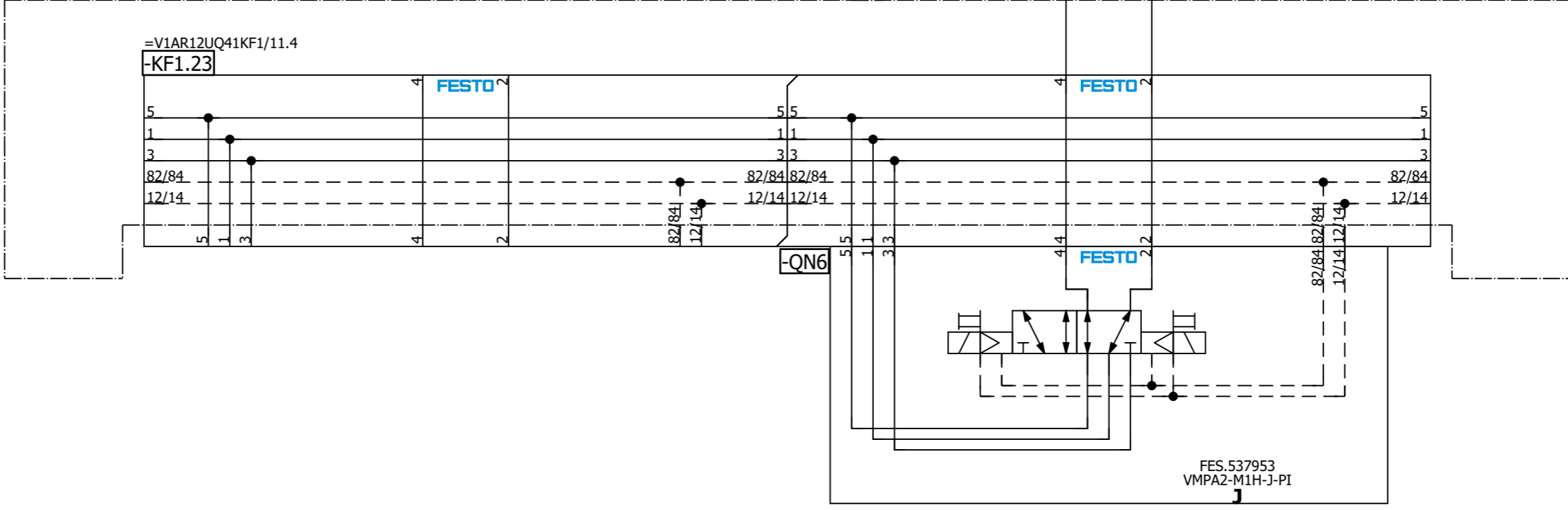

=V1AR12UQ41  
-UQ6-QN6.1  
L150 Model  
Clamps (RST)

=V1AR12UQ41  
-UQ6-QN6.2  
L150 Model  
Clamps (SET)

=V1AR12UQ41UQ5/1

=V1AR12UQ41UQ7/1

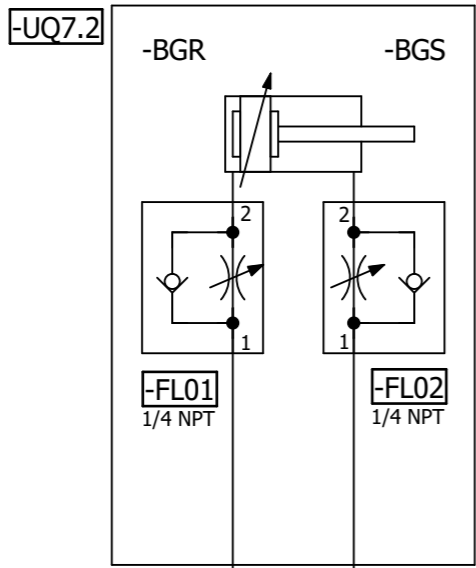
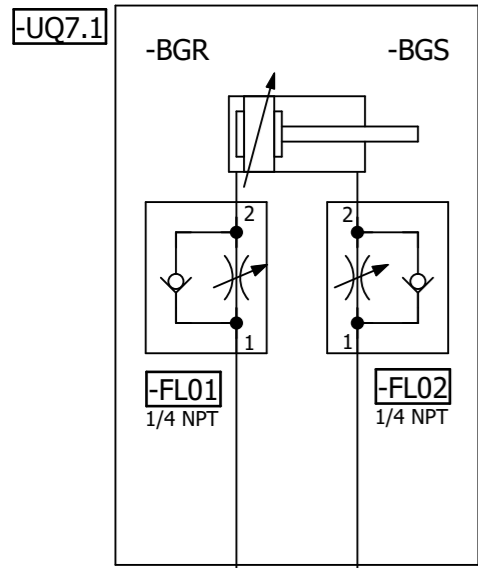

=V1AR12UQ41KF1

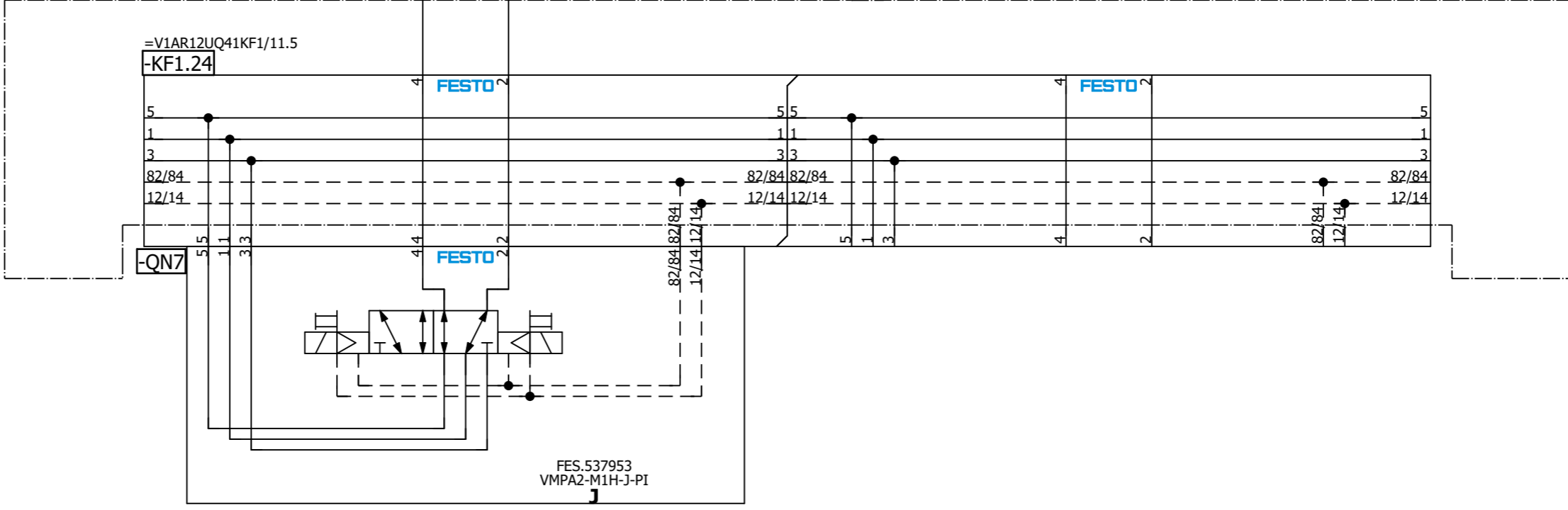

=V1AR12UQ41  
-UQ7-QN7.1  
L230 Model  
Clamps (RST)

=V1AR12UQ41  
-UQ7-QN7.2  
L230 Model  
Clamps (SET)

=V1AR12UQ41UQ6/1

=V1AR12UQ41UQ8/1

Date: 12/21/2022		Volvo Trucks North America		Valiant TMS		Drawing name: =2V04&MFS-PNEU		= V1AR12UQ41UQ7	
Ed.: MKLEPADLO		P6700 Underbody Mainline - Cell 2V04		L230 Model Clamps		Document type: MFS		+ V1AR12UQ41	
Appr:		Replacement of		Scale 1:1		Project nr: 22-16151		Page 1	
Original		Replaced by						227	

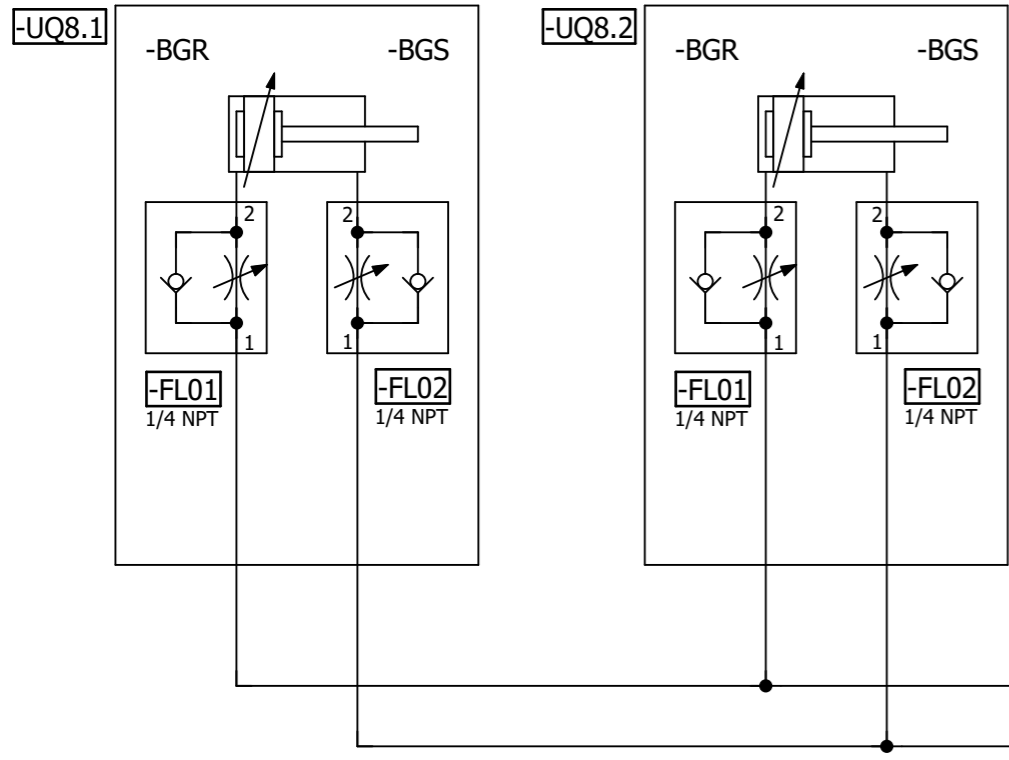

=V1AR12UQ41KF1

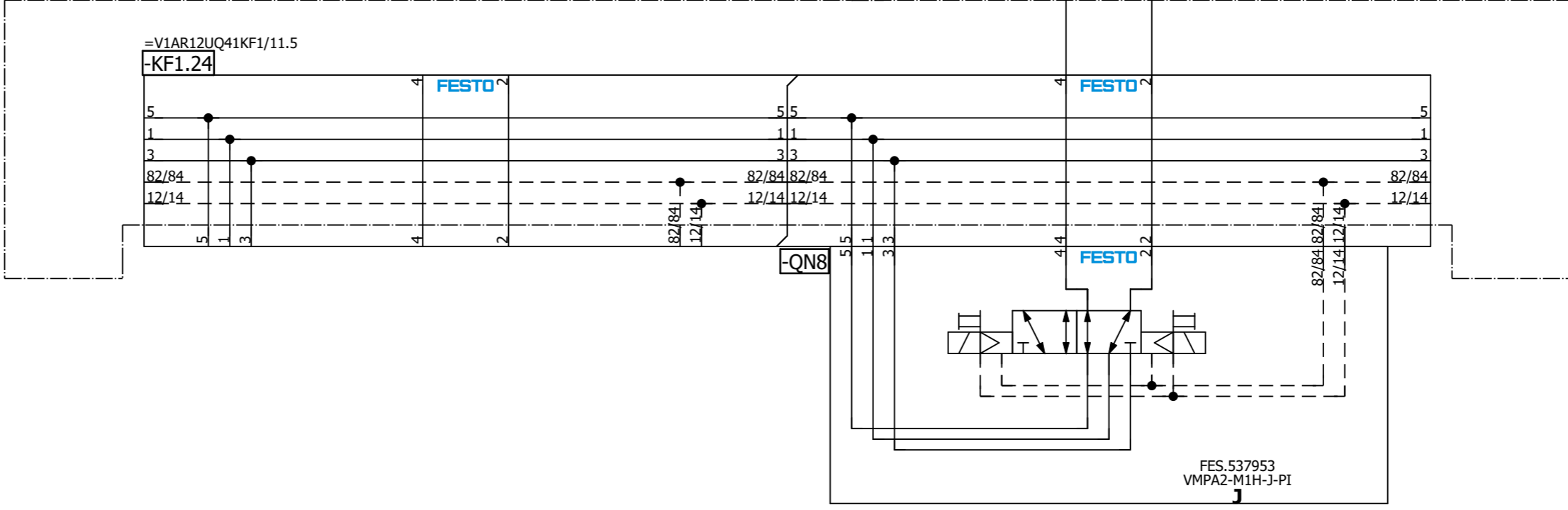

=V1AR12UQ41  
-UQ8-QN8.1  
L290 Model  
Clamps (RST)

=V1AR12UQ41  
-UQ8-QN8.2  
L290 Model  
Clamps (SET)

=V1AR12UQ41UQ7/1

=V1AR12UQ41UQ9/1



=V1AR12UQ41KF1

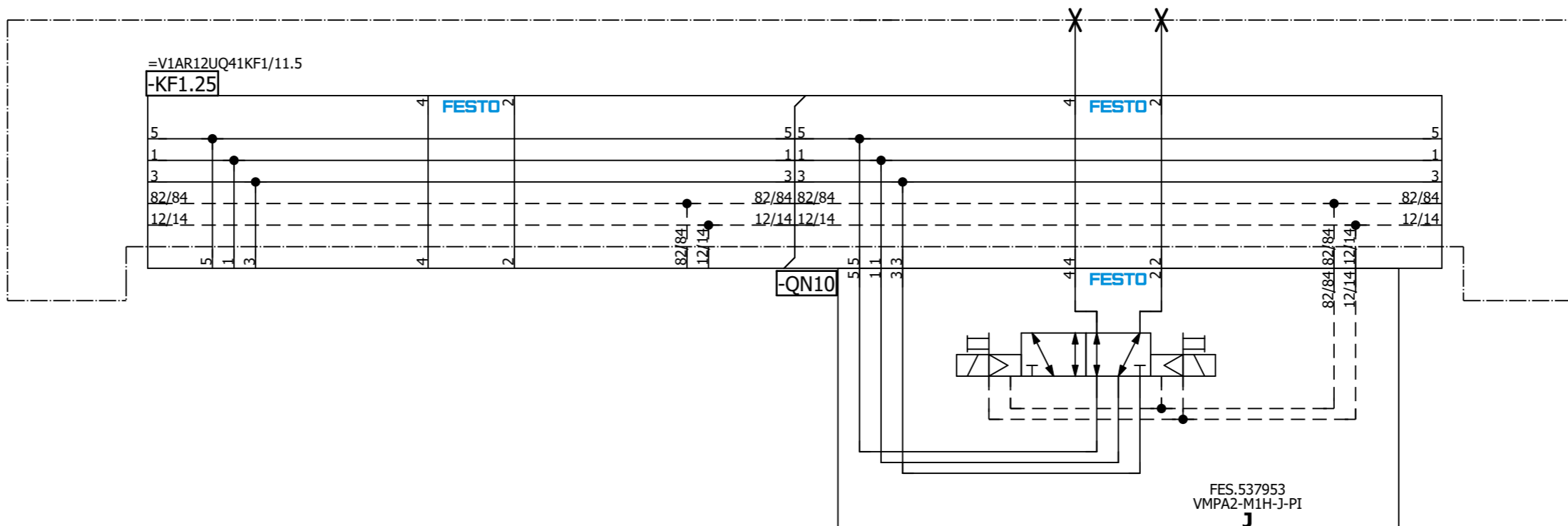

=V1AR12UQ41  
-UQ10-QN10.1  
Spare  
(RST)

=V1AR12UQ41  
-UQ10-QN10.2  
Spare  
(SET)

=V1AR13UQ41KF1+.AR13UQ41/1

=V1AR12UQ41UQ9/1

Date		12/21/2022		Volvo Trucks North America		Valiant TMS		Spare		Drawing name:		= V1AR12UQ41UQ10	
Ed.		MKLEPADLO		P6700 Underbody Mainline - Cell 2V04		Scale 1:1				Document type:		= V1AR12UQ41	
Appr.				Replacement of		Replaced by				Project nr:		Page	
Original										22-16151		1	
Modification		Date		Name		Original				MFS		227	





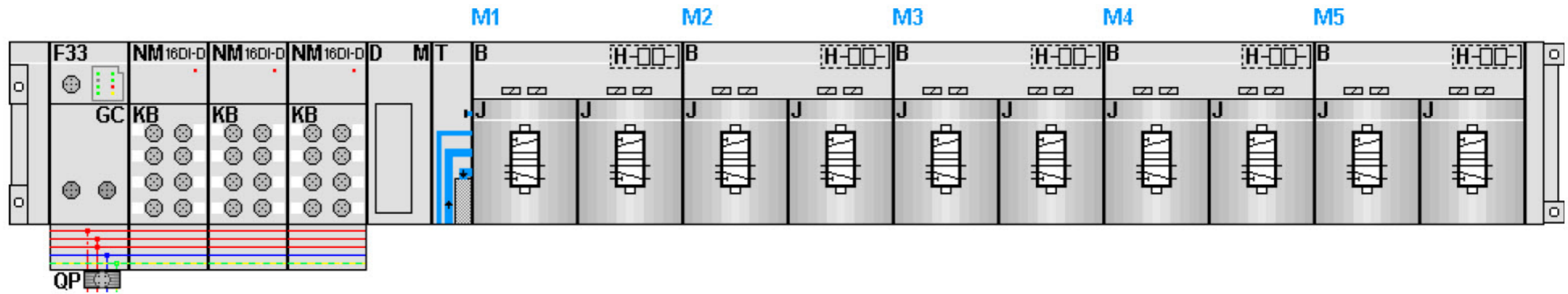

KF1.0

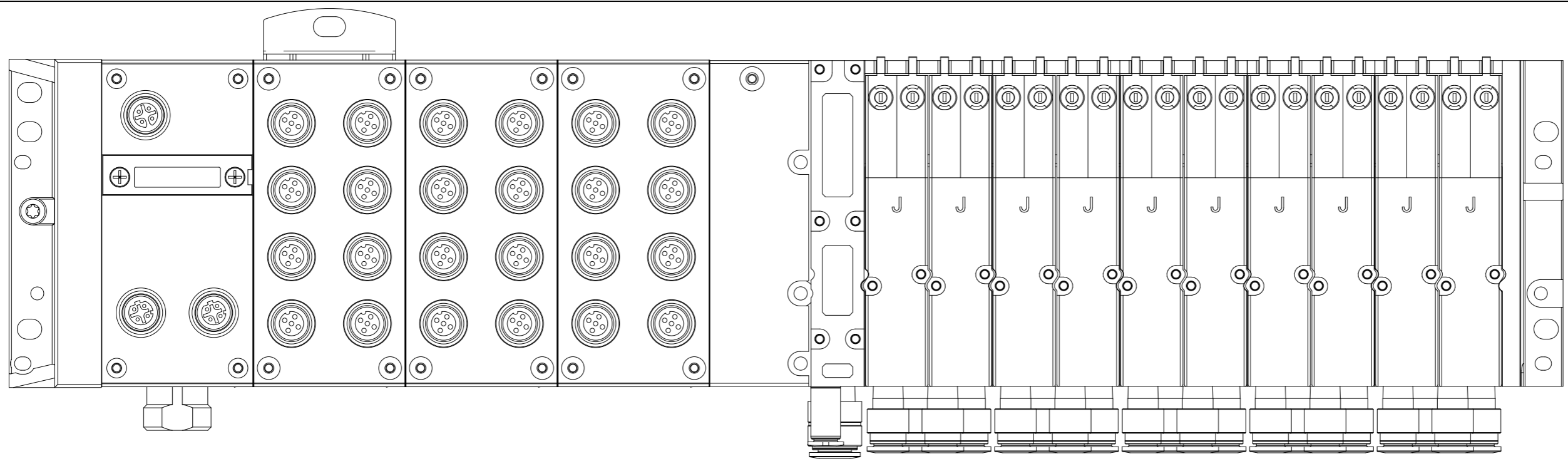

		Date	12/21/2022	Volvo Trucks North America			Valiant TMS	AIR SUPPLY	Drawing name:		= V1AR13UQ41KF1
		Ed.	MKLEPADLO	P6700 Underbody Mainline - Cell 2V04					= 2V04&MFS-PNEU		+ V1AR13UQ41
		Appr		Replacement of		Replaced by	Scale 1:1		Document type:	Project nr:	Page
Modification	Date	Name	Original						MFS	22-16151	5
											227

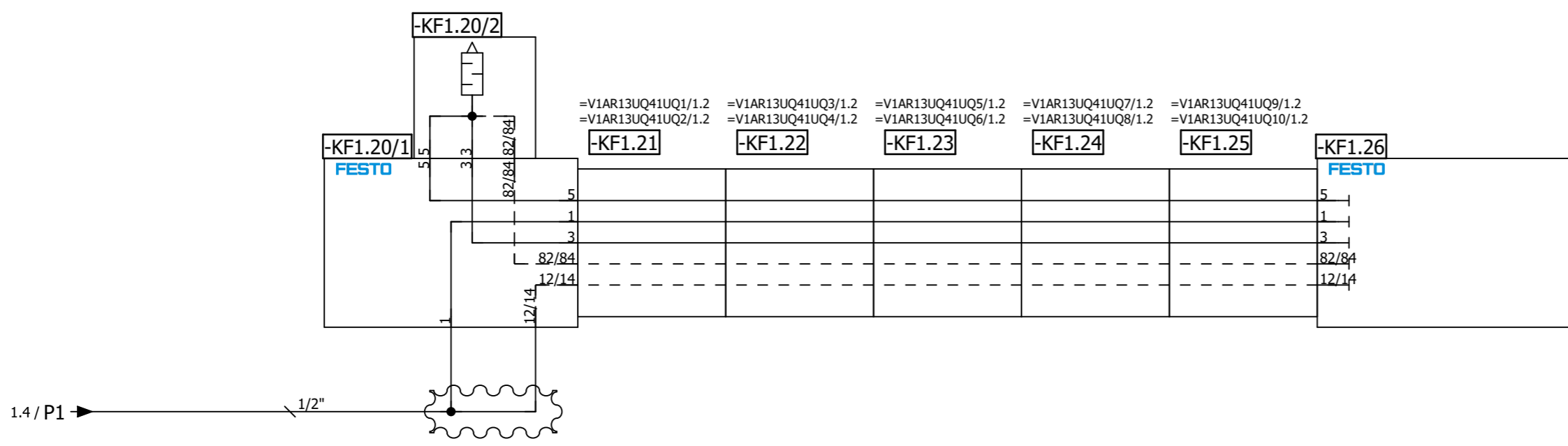
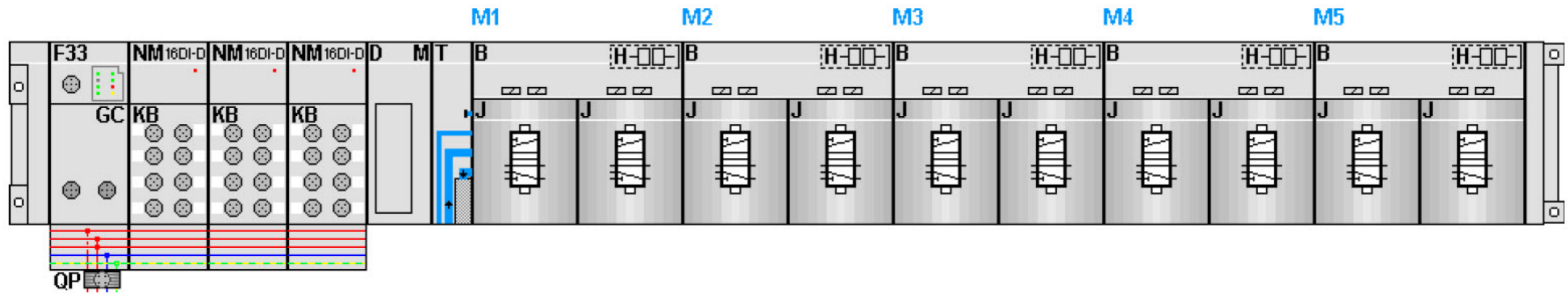

Date		12/21/2022	Volvo Trucks North America		Valiant TMS		AIR SUPPLY		Drawing name:		= V1AR13UQ41KF1	
Ed.		MKLEPADLO	P6700 Underbody Mainline - Cell 2V04		Scale 1:1				=2V04&MFS-PNEU		+ V1AR13UQ41	
Appr			Replacement of		Replaced by				Document type:		Project nr:	
Original									MFS		22-16151	
Modification		Date	Name								Page	
											11	
											227	

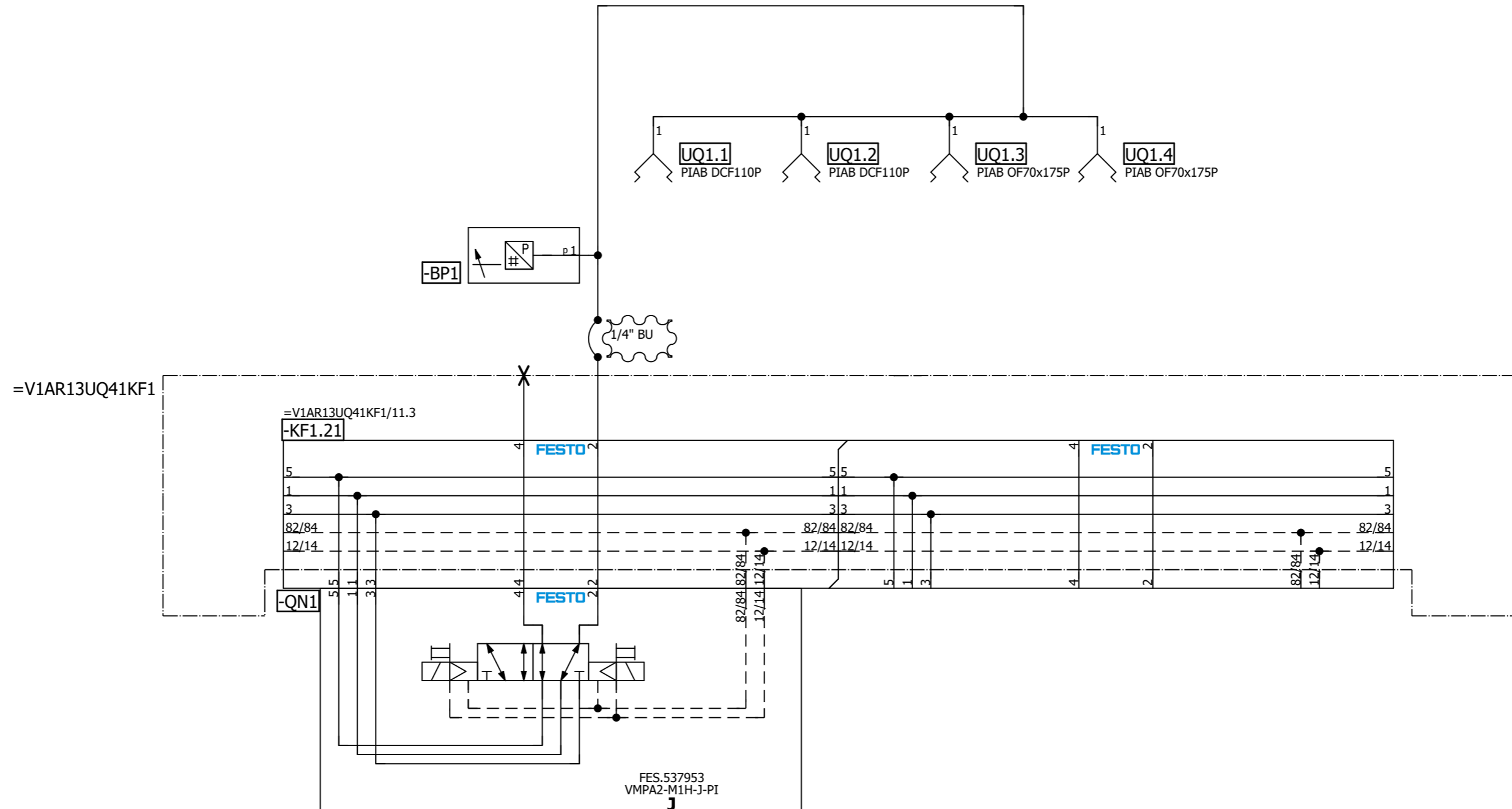

=V1AR13UQ41  
-UQ1-QN1.1  
Common  
Vacuums (RST)

=V1AR13UQ41  
-UQ1-QN1.2  
Common  
Vacuums (SET)

=V1AR13UQ41KF1/11

=V1AR13UQ41UQ2/1

Date		12/21/2022	Volvo Trucks North America		Valiant TMS		Common Vacuums		Drawing name:		= V1AR13UQ41UQ1	
Ed.		MKLEPADLO	P6700 Underbody Mainline - Cell 2V04		Scale 1:1				=2V04&MFS-PNEU		+ V1AR13UQ41	
Appr.			Replacement of		Replaced by				Document type:		Project nr:	
Original									MFS		22-16151	
Modification		Date	Name		Original						Page	
											1	
											227	

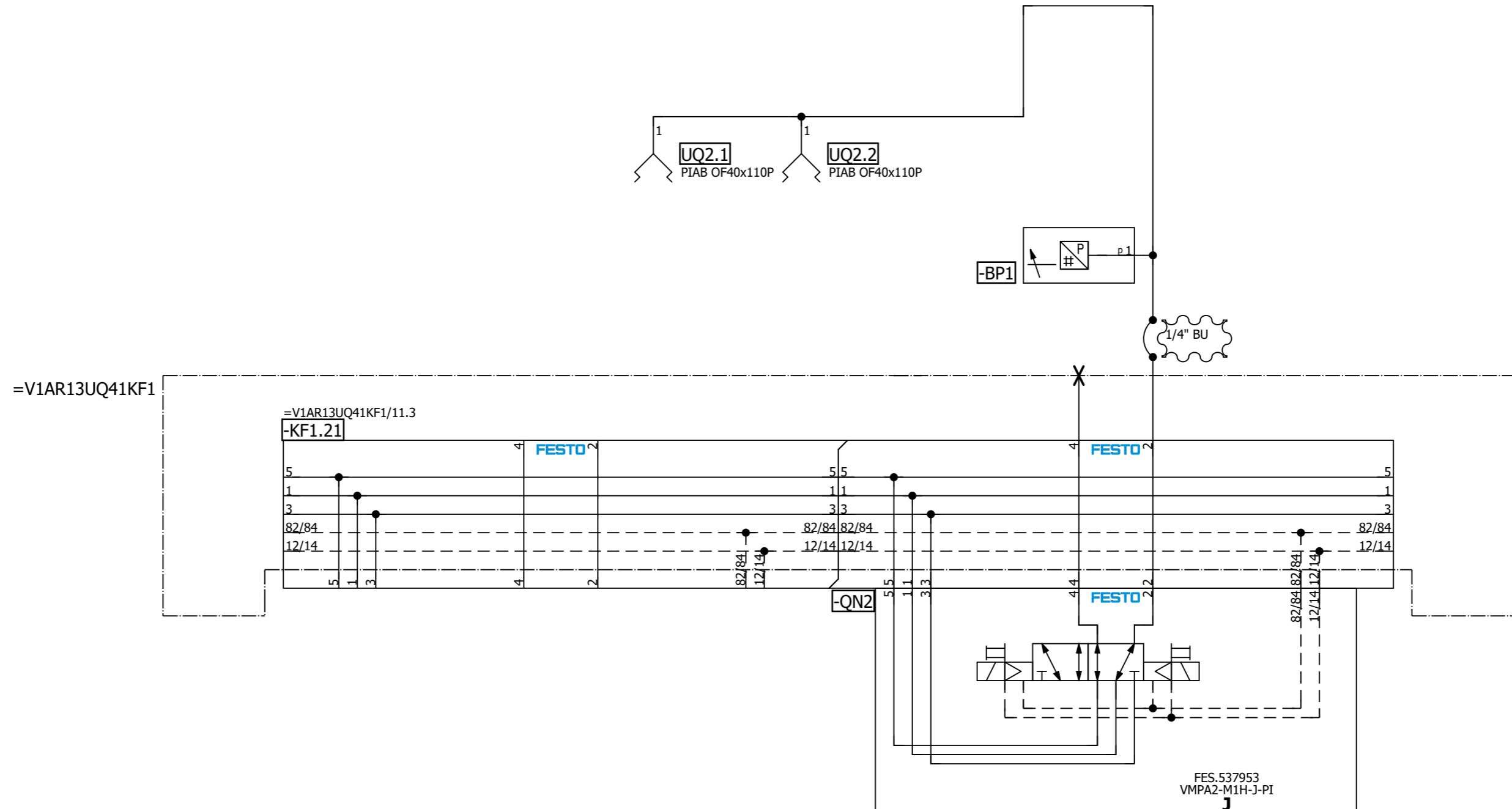

=V1AR13UQ41KF1

=V1AR13UQ41KF1/11.3

-KF1.21

=V1AR13UQ41  
-UQ2-QN2.1  
L230/320 Model  
Vacuums (RST)

=V1AR13UQ41  
-UQ2-QN2.2  
L230/320 Model  
Vacuums (SET)

=V1AR13UQ41UQ1/1

=V1AR13UQ41UQ3/1

Date		12/21/2022		Volvo Trucks North America		Valiant TMS		L230/320 Model Vacuums		Drawing name:		= V1AR13UQ41UQ2	
Ed.		MKLEPADLO		P6700 Underbody Mainline - Cell 2V04		Scale 1:1				=2V04&MFS-PNEU		+ V1AR13UQ41	
Appr.				Replacement of		Replaced by				Document type:		Project nr:	
Original										MFS		22-16151	
Modification		Date		Name		Original						Page	
												1	
												227	



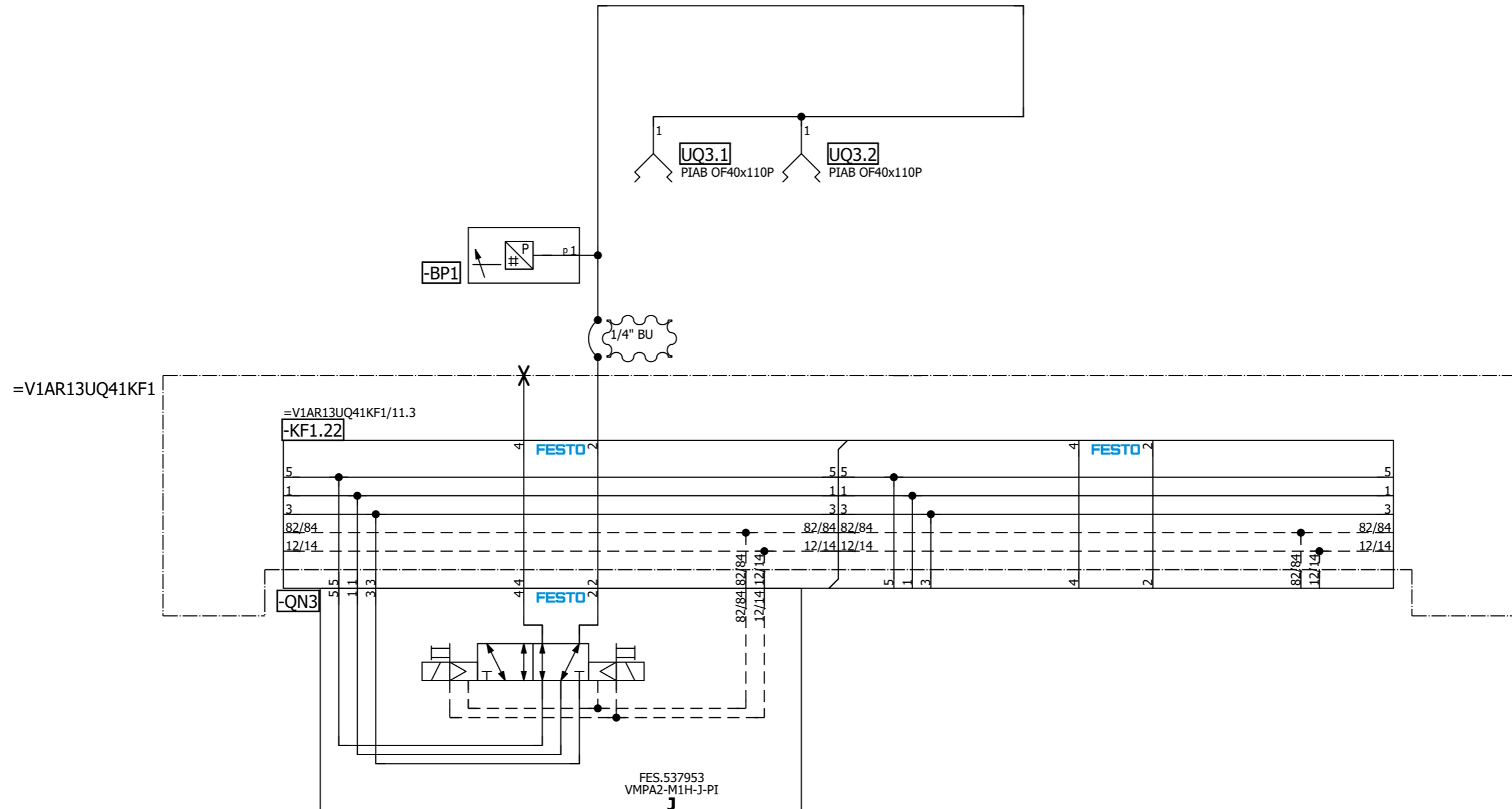

=V1AR13UQ41  
-UQ3-QN3.1  
L290 Model  
Vacuums (RST)

=V1AR13UQ41  
-UQ3-QN3.2  
L290 Model  
Vacuums (SET)

=V1AR13UQ41UQ2/1

=V1AR13UQ41UQ4/1

Date		12/21/2022	Volvo Trucks North America		Valiant TMS		L290 Model Vacuums		Drawing name:		= V1AR13UQ41UQ3	
Ed.		MKLEPADLO	P6700 Underbody Mainline - Cell 2V04		Scale 1:1				=2V04&MFS-PNEU		+ V1AR13UQ41	
Appr.			Replacement of		Replaced by				Document type:		Project nr:	
Original									MFS		22-16151	
Modification		Date	Name		Original						Page	
											1	
											227	



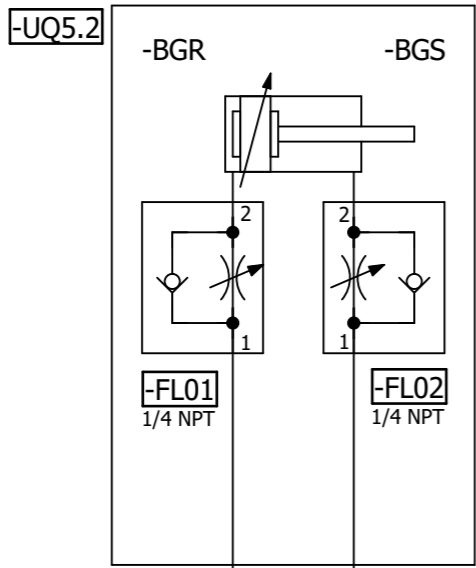
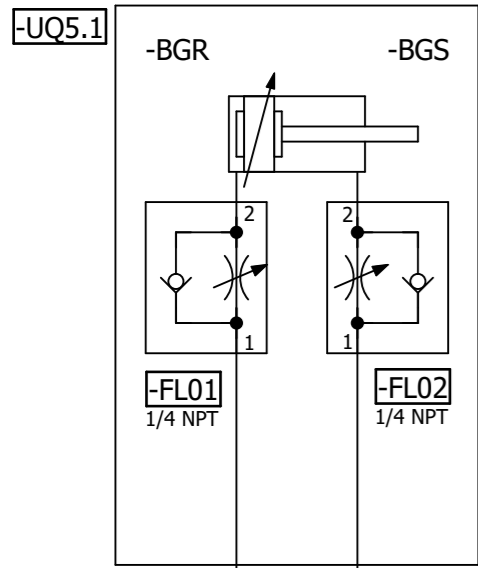

=V1AR13UQ41KF1

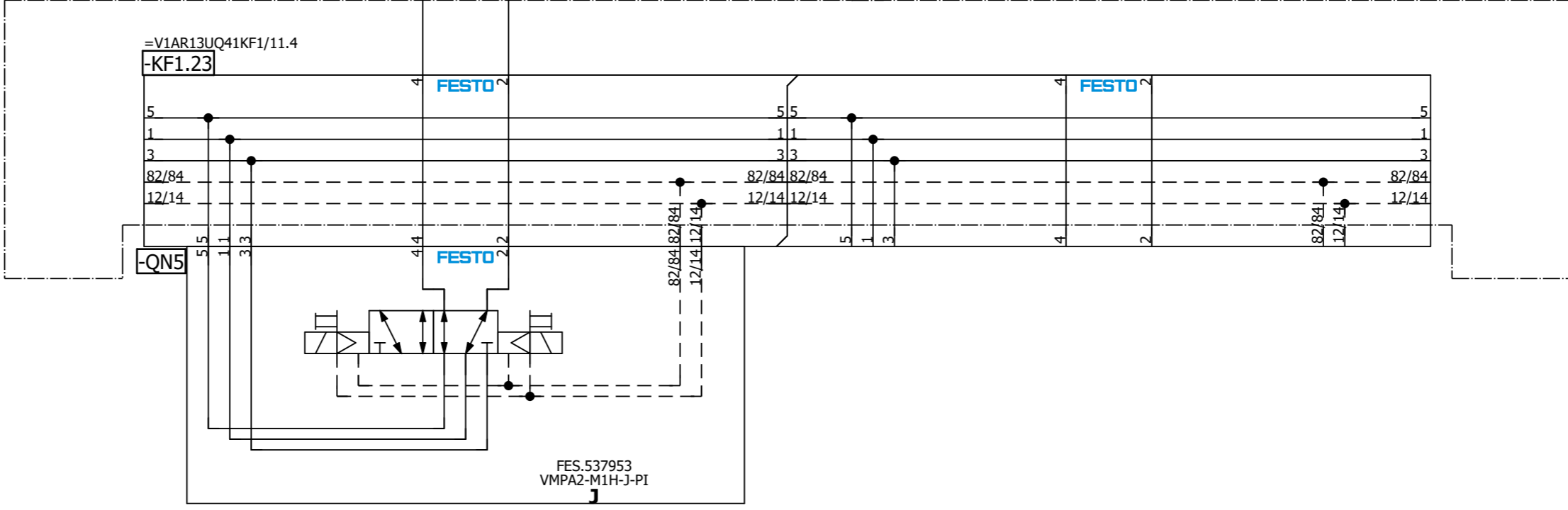

=V1AR13UQ41  
-UQ5-QN5.1  
Common  
Clamps (RST)

=V1AR13UQ41  
-UQ5-QN5.2  
Common  
Clamps (SET)

=V1AR13UQ41UQ4/1

=V1AR13UQ41UQ6/1

Date: 12/21/2022		Volvo Trucks North America		Valiant TMS		Drawing name: =2V04&MFS-PNEU		= V1AR13UQ41UQ5	
Ed.: MKLEPADLO		P6700 Underbody Mainline - Cell 2V04		Common Clamps		Document type: MFS		+ V1AR13UQ41	
Appr:		Replacement of		Scale 1:1		Project nr: 22-16151		Page 1	
Original		Replaced by						227	



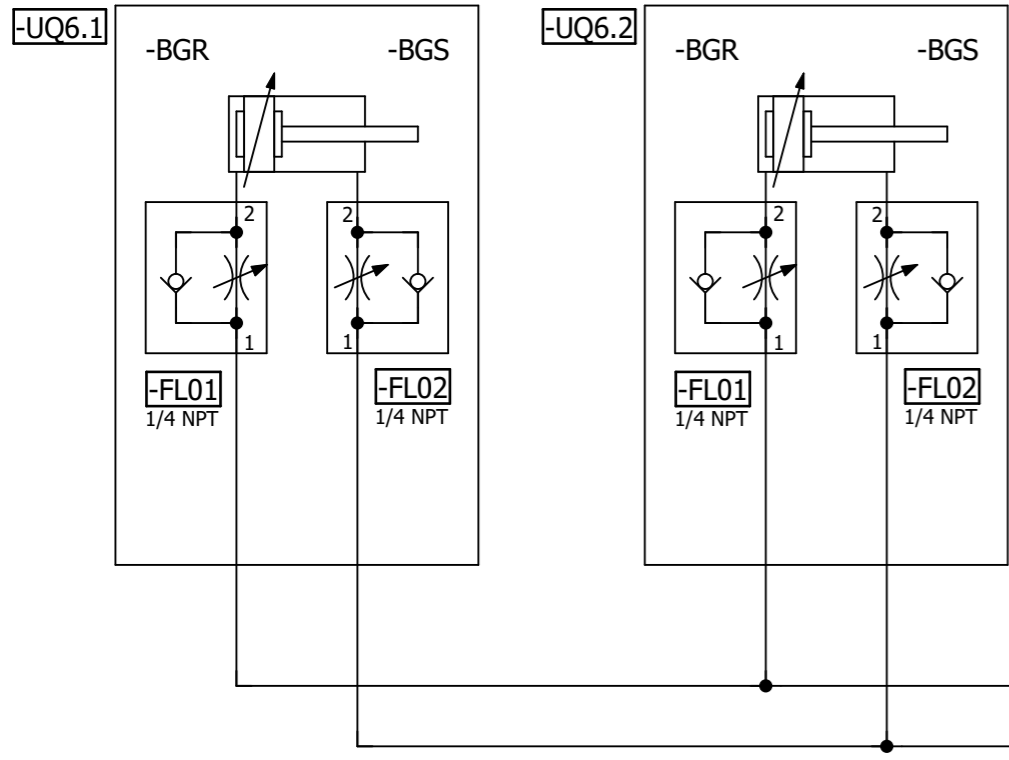

=V1AR13UQ41KF1

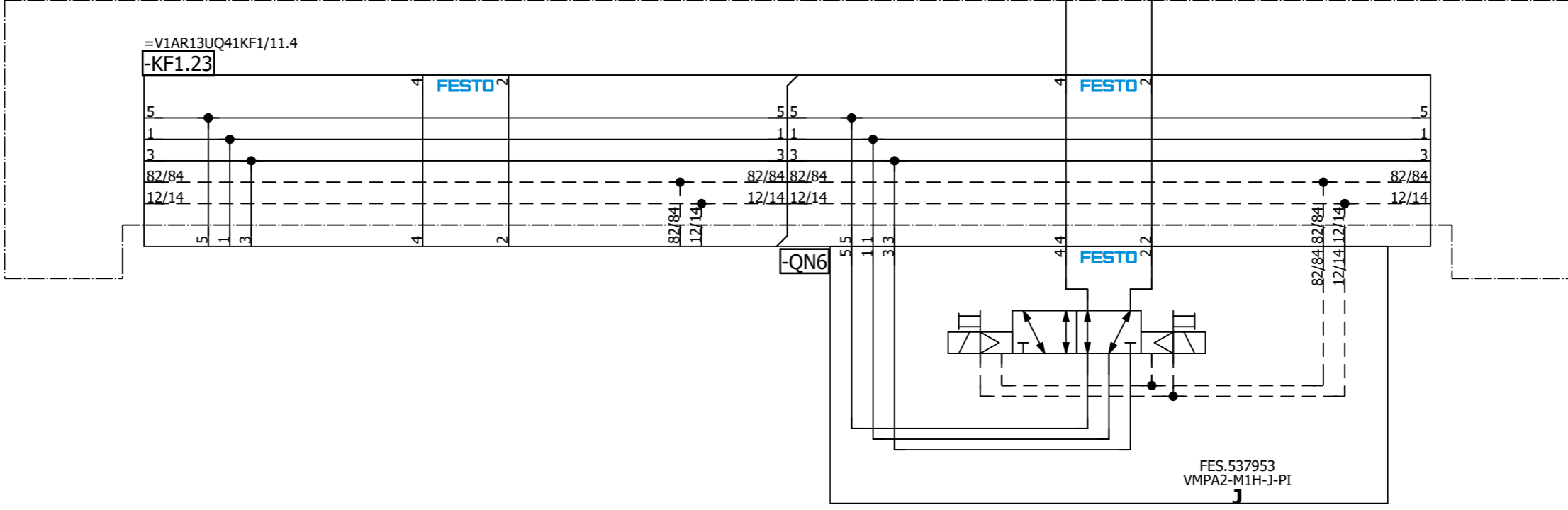

=V1AR13UQ41  
-UQ6-QN6.1  
L150 Model  
Clamps (RST)

=V1AR13UQ41  
-UQ6-QN6.2  
L150 Model  
Clamps (SET)

=V1AR13UQ41UQ5/1

=V1AR13UQ41UQ7/1

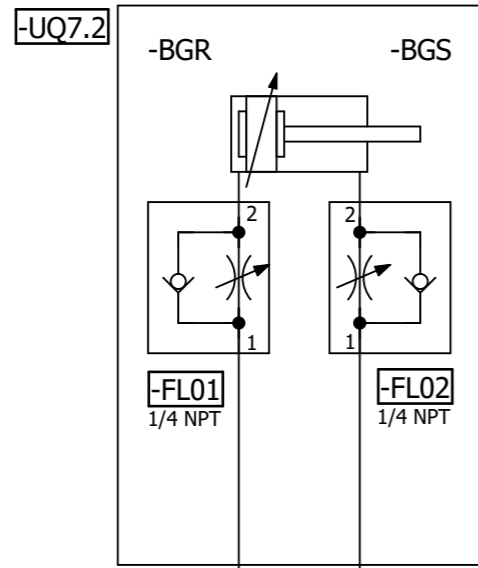
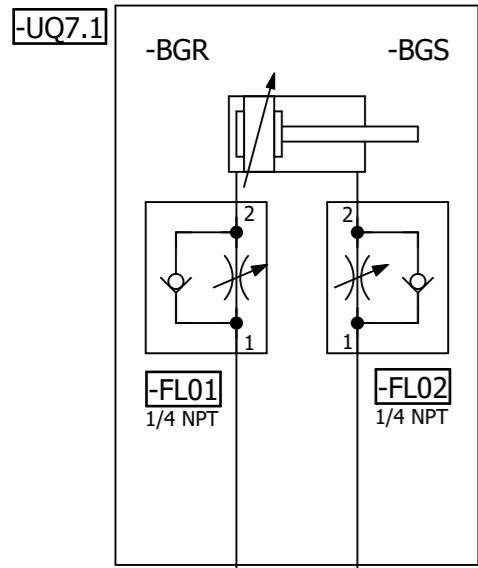

=V1AR13UQ41KF1

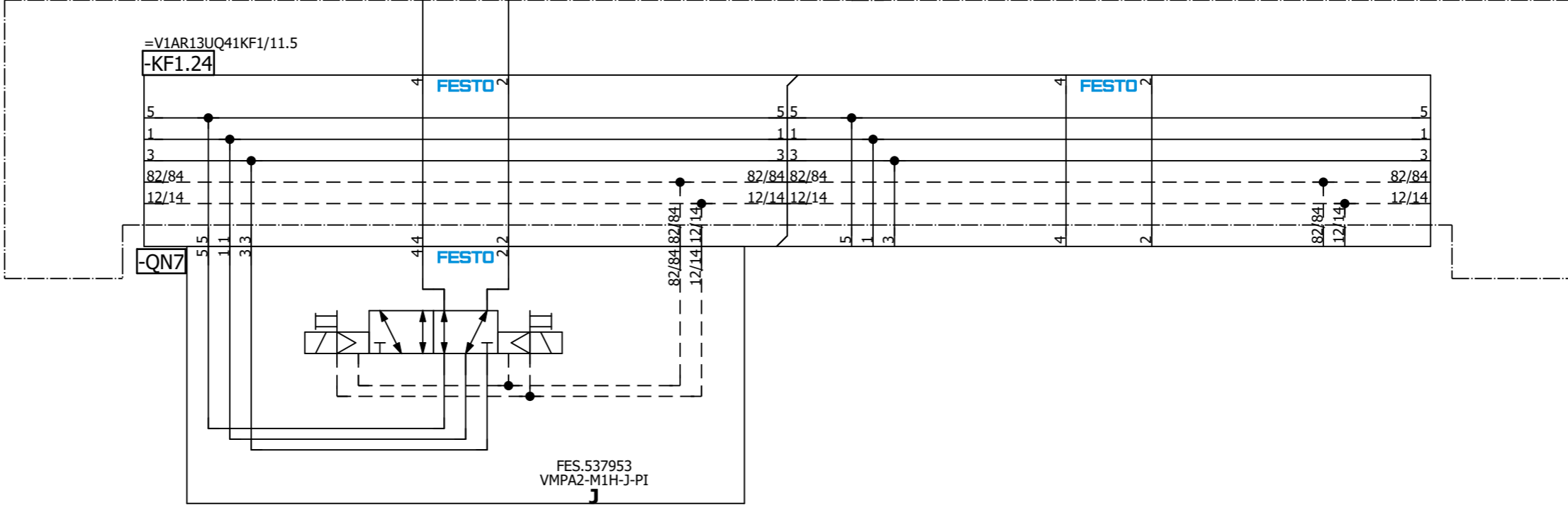

=V1AR13UQ41  
-UQ7-QN7.1  
L230 Model  
Clamps (RST)

=V1AR13UQ41  
-UQ7-QN7.2  
L230 Model  
Clamps (SET)

=V1AR13UQ41UQ6/1

=V1AR13UQ41UQ8/1

Date: 12/21/2022		Volvo Trucks North America		Valiant TMS		Drawing name: =2V04&MFS-PNEU		= V1AR13UQ41UQ7	
Ed.: MKLEPADLO		P6700 Underbody Mainline - Cell 2V04		L230 Model Clamps		Document type: MFS		+ V1AR13UQ41	
Appr:		Replacement of		Replaced by		Project nr: 22-16151		Page 1	
Original								227	

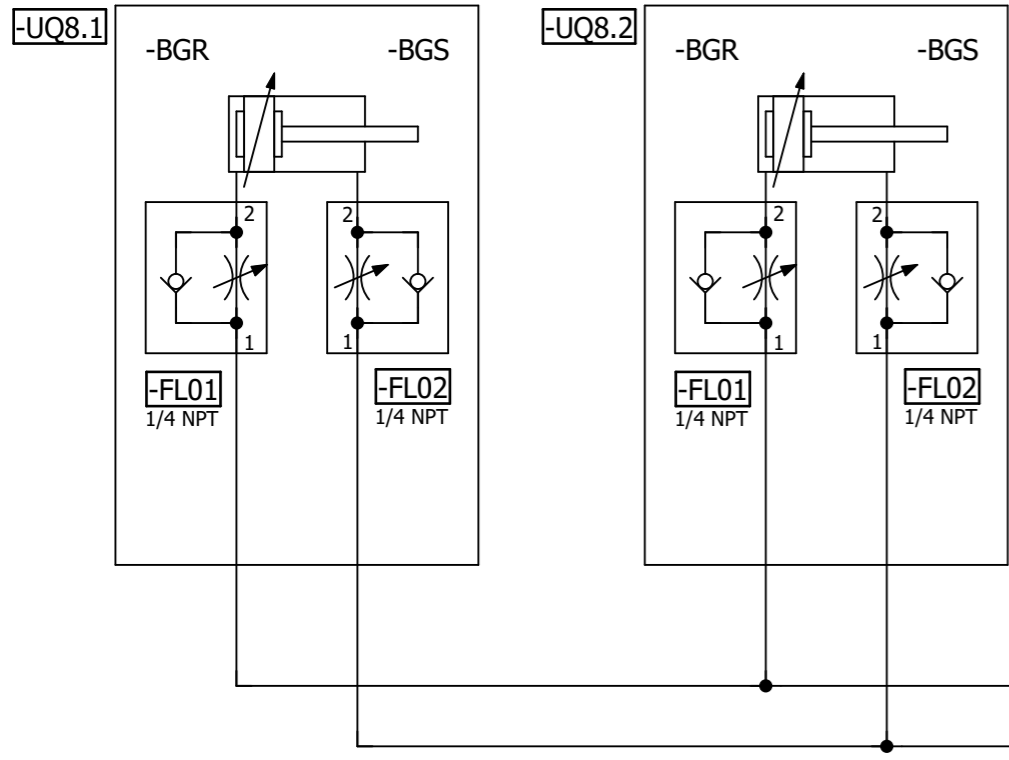

=V1AR13UQ41KF1

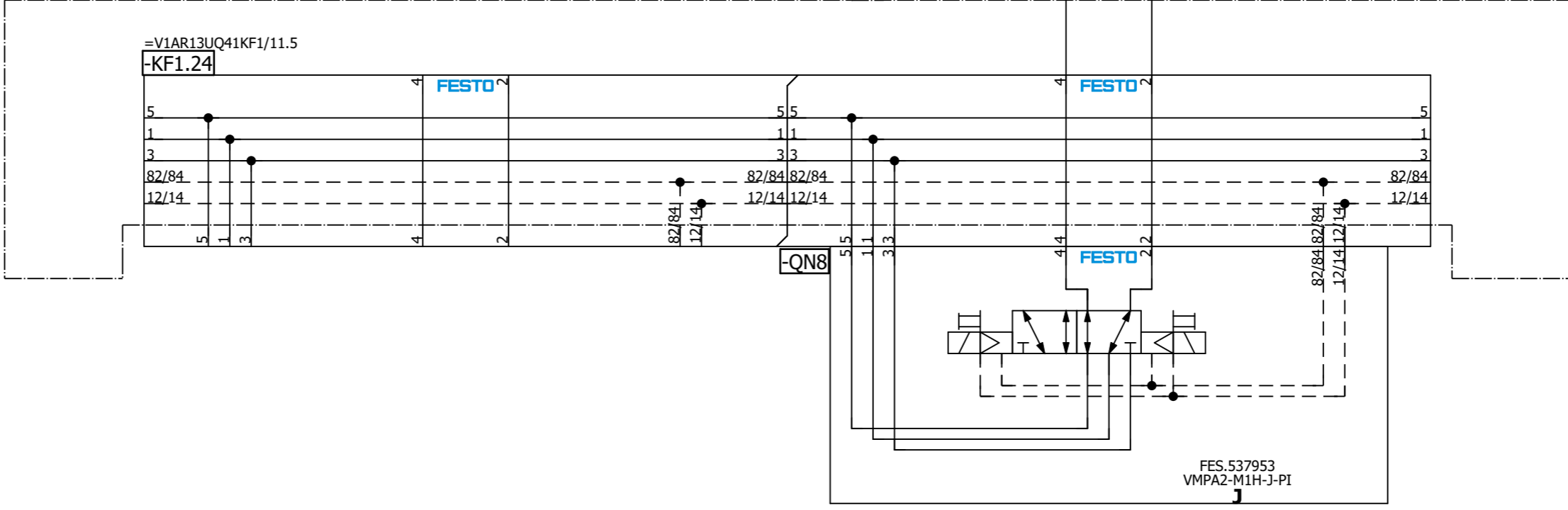

=V1AR13UQ41  
-UQ8-QN8.1  
L290 Model  
Clamps (RST)

=V1AR13UQ41  
-UQ8-QN8.2  
L290 Model  
Clamps (SET)

=V1AR13UQ41UQ7/1

=V1AR13UQ41UQ9/1

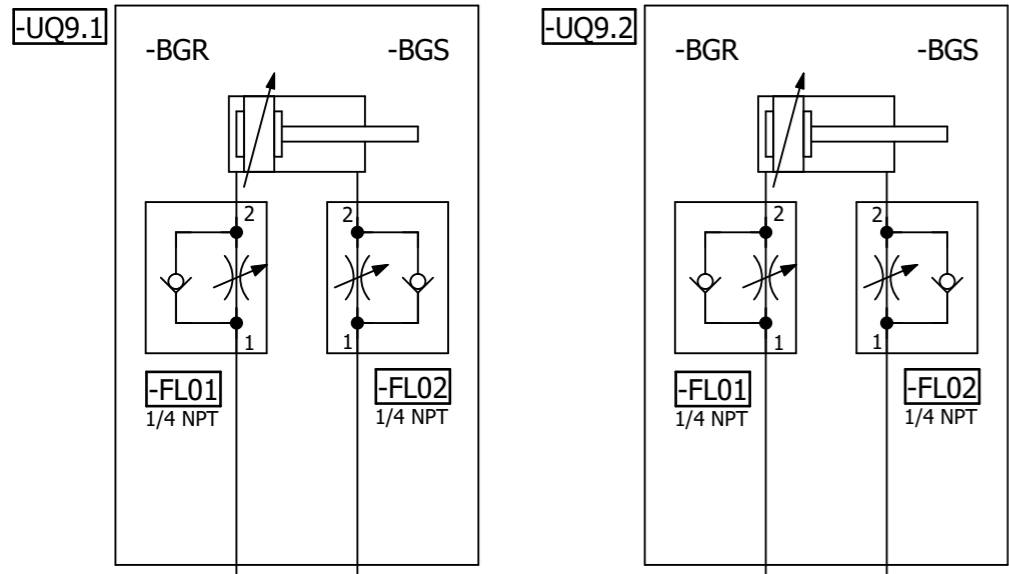

=V1AR13UQ41KF1

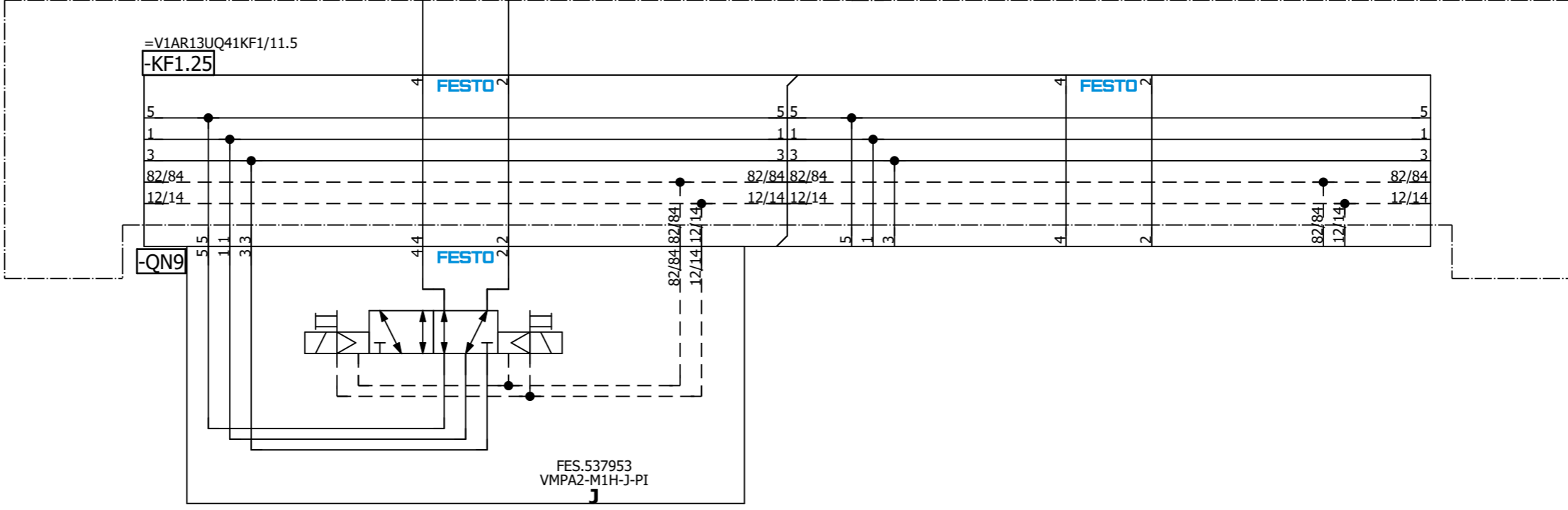

=V1AR13UQ41  
-UQ9-QN9.1  
L320 Model  
Clamps (RST)

=V1AR13UQ41  
-UQ9-QN9.2  
L320 Model  
Clamps (SET)

=V1AR13UQ41UQ8/1

=V1AR13UQ41UQ10/1

Modification		Date	Name	Date	12/21/2022	Ed.	MKLEPADLO	Volvo Trucks North America			Valiant TMS	L320 Model Clamps	Drawing name:	= V1AR13UQ41UQ9					
				Appr.				P6700 Underbody Mainline - Cell 2V04			Scale 1:1		Drawing type:	= 2V04&MFS-PNEU					
				Original		Replacement of		Replaced by					Document type:	MFS	Project nr:	22-16151	Page	1	
																			227



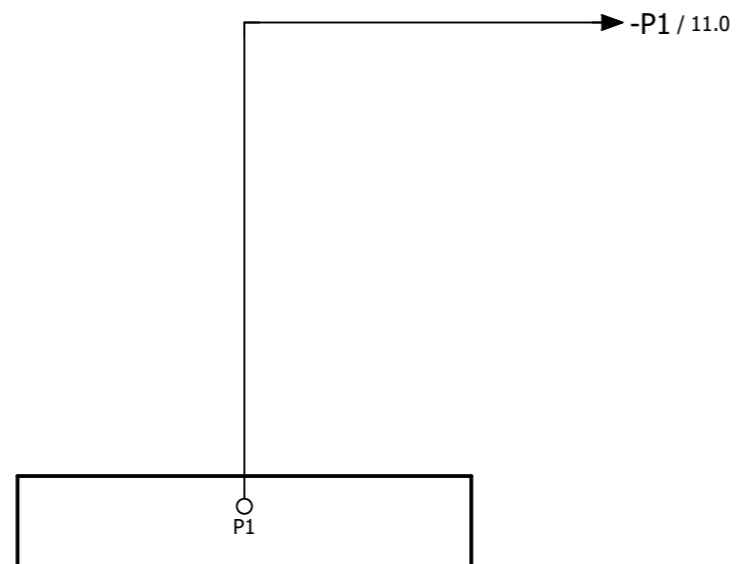

=V1AR13UQ41UQ10+.AR13UQ41/1

		Date	12/21/2022	Volvo Trucks North America		Valiant TMS	AIR SUPPLY GRIPPER	Drawing name: =2V04&MFS-PNEU		= V1AR14UQ41KF1 + V1AR14UQ41	
		Ed.	MKLEPADLO	P6700 Underbody Mainline - Cell 2V04					Document type: MFS	Project nr: 22-16151	Page
Modification	Date	Name	Original	Replacement of	Replaced by	Scale 1:1					227

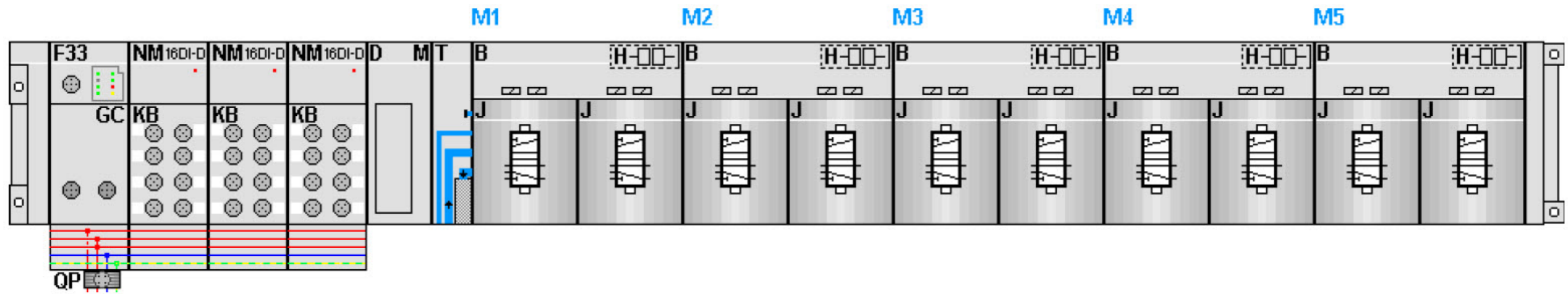

KF1.0

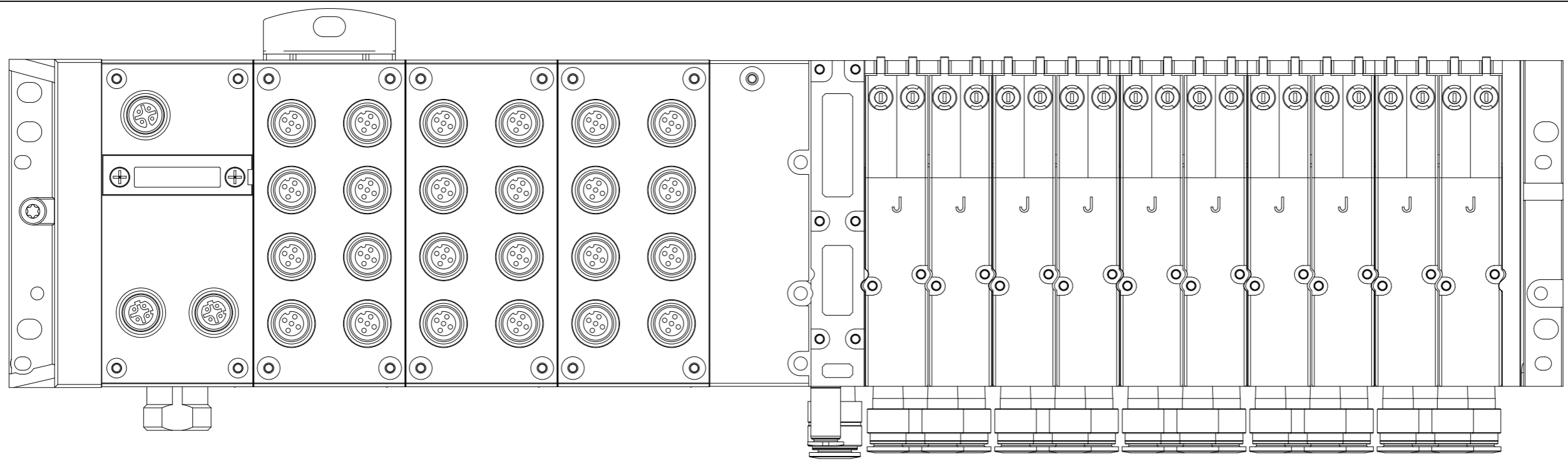

Date		12/21/2022	Volvo Trucks North America		Valiant TMS	AIR SUPPLY	Drawing name:		= V1AR14UQ41KF1			
Ed.		MKLEPADLO	P6700 Underbody Mainline - Cell 2V04				= 2V04&MFS-PNEU		+ V1AR14UQ41			
Appr			Replacement of		Scale 1:1	Document type:		MFS	Project nr:	22-16151	Page	5
Original			Replaced by			MFS		22-16151		227		

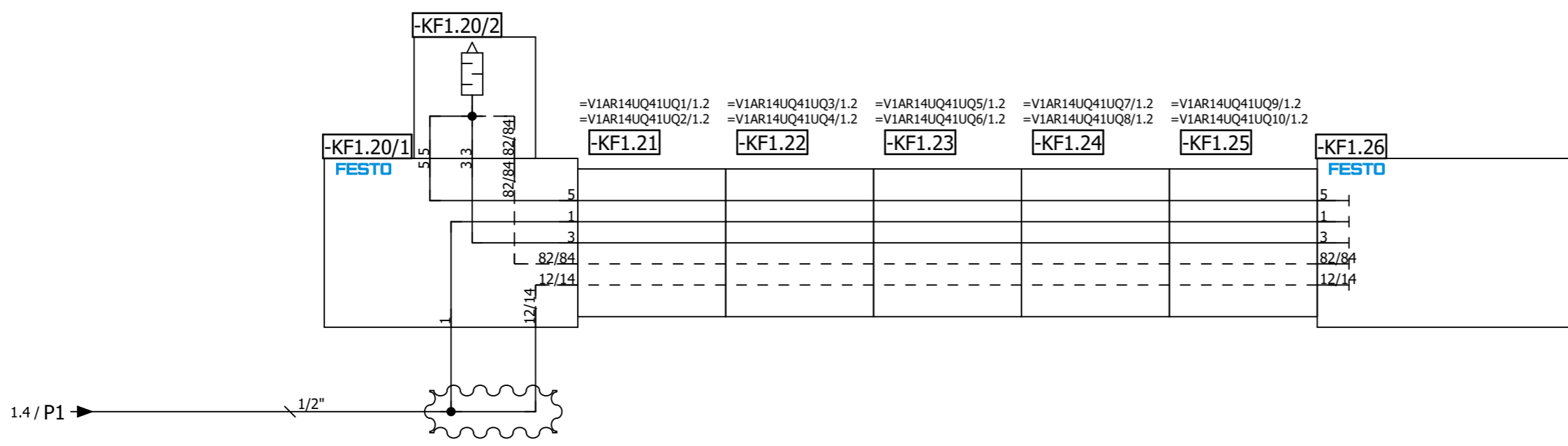
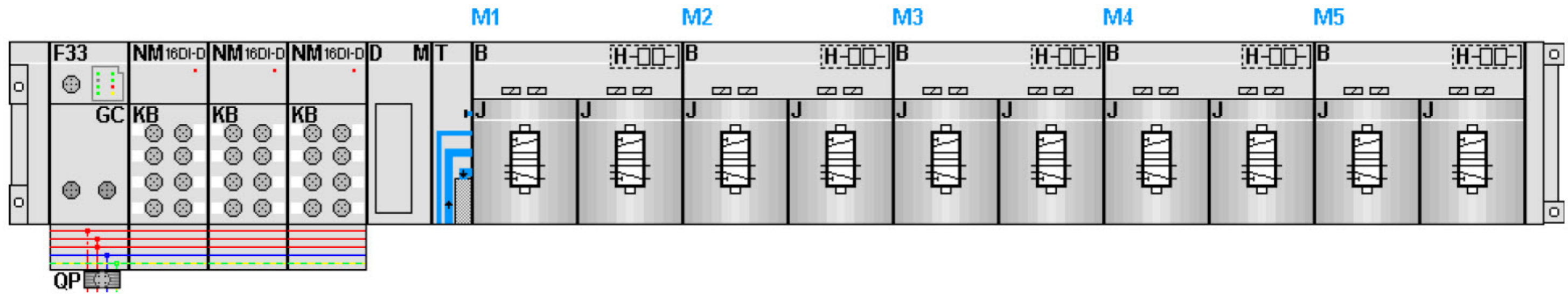



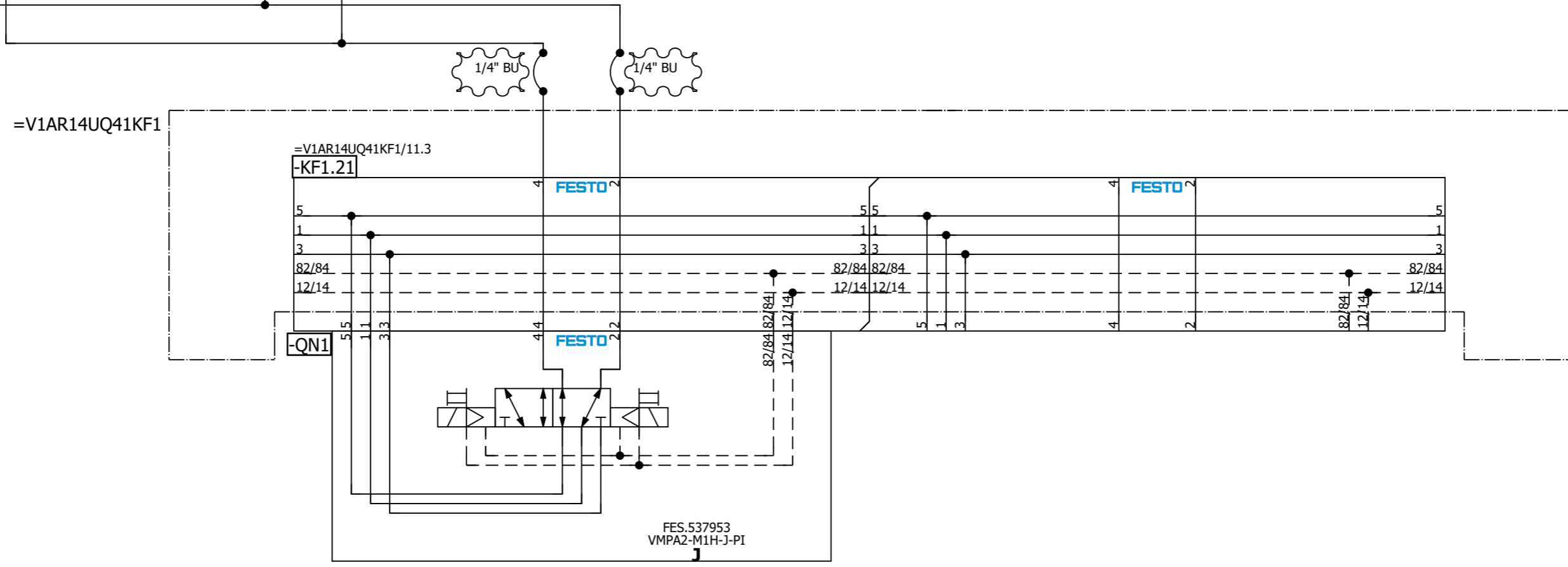
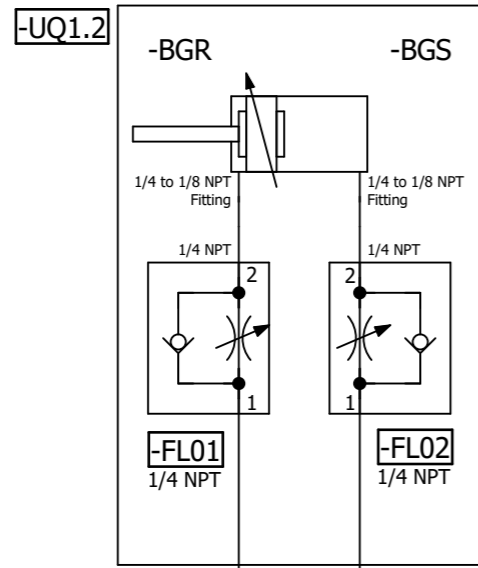
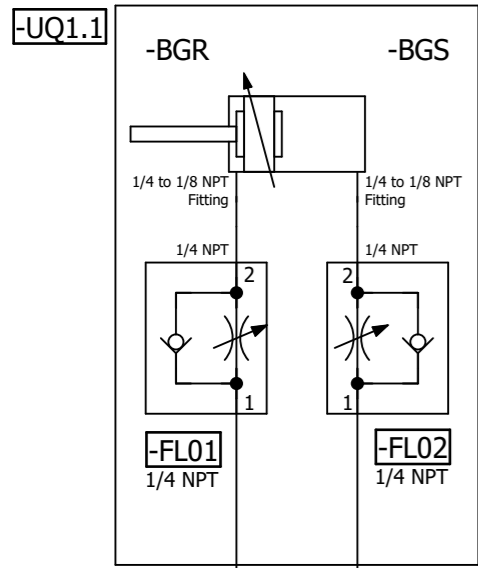

**=V1AR14UQ41**  
**-UQ1-Q1.1**  
**Common**  
**Shot Pins (RST)**

**=V1AR14UQ41**  
**-UQ1-Q1.2**  
**Common**  
**Shot Pins (SET)**

=V1AR14UQ41KF1/11

=V1AR14UQ41UQ2/1

Date: 12/21/2022		Volvo Trucks North America		Valiant TMS		Drawing name: =2V04&MFS-PNEU		= V1AR14UQ41UQ1	
Ed.: MKLEPADLO		P6700 Underbody Mainline - Cell 2V04		Common Shot Pins		Document type: MFS		+ V1AR14UQ41	
Appr:		Replacement of:		Scale 1:1		Project nr: 22-16151		Page 1	
Original:		Replaced by:						227	



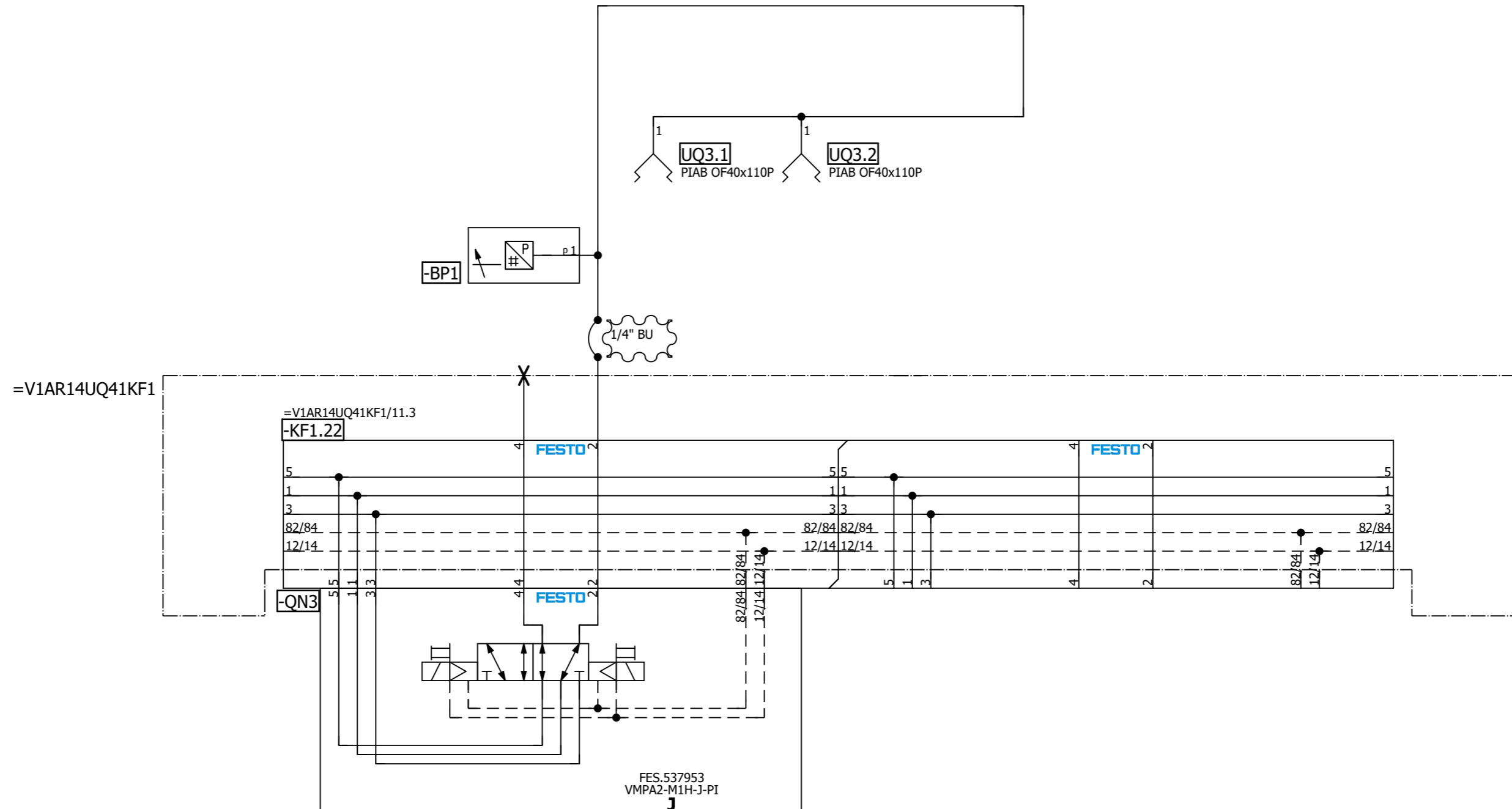

=V1AR14UQ41  
-UQ3-QN3.1  
L230/320 Model  
Vacuums (RST)

=V1AR14UQ41  
-UQ3-QN3.2  
L230/320 Model  
Vacuums (SET)

=V1AR14UQ41UQ2/1

=V1AR14UQ41UQ4/1

Date		12/21/2022	Volvo Trucks North America		Valiant TMS	L230/320 Model Vacuums	Drawing name:		= V1AR14UQ41UQ3
Ed.		MKLEPADLO	P6700 Underbody Mainline - Cell 2V04				=2V04&MFS-PNEU		+ V1AR14UQ41
Appr.			Replacement of		Scale 1:1		Document type:		MFS
Original			Replaced by				Project nr:		22-16151
Modification	Date	Name	Original				Page		1
									227





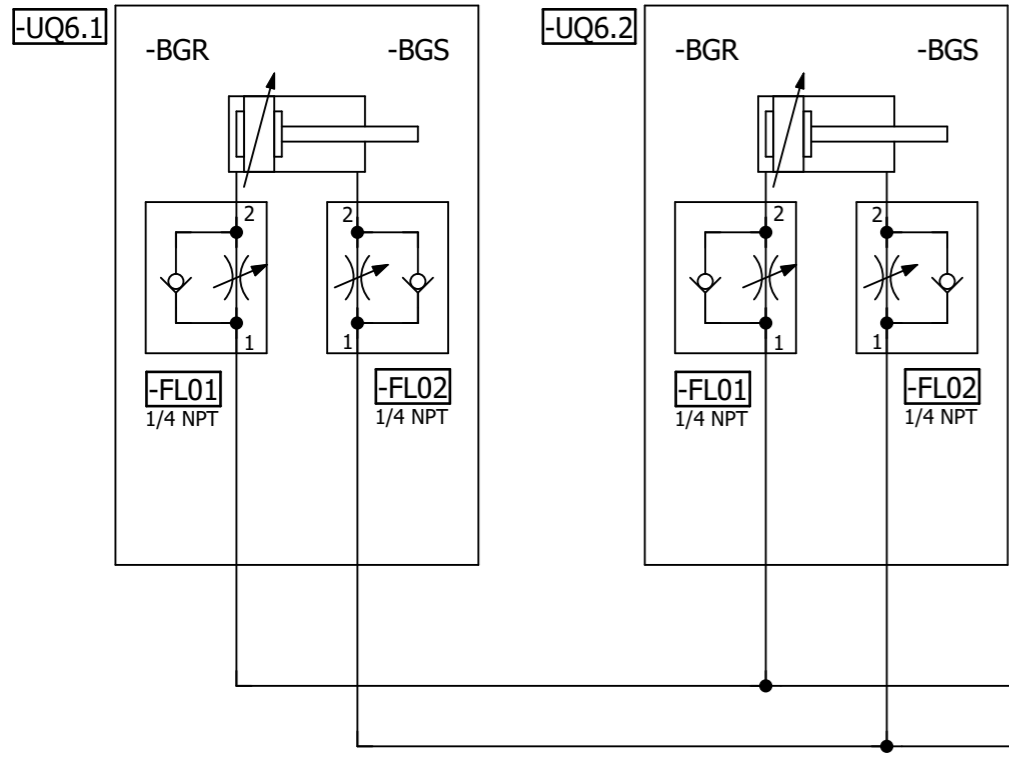

=V1AR14UQ41KF1

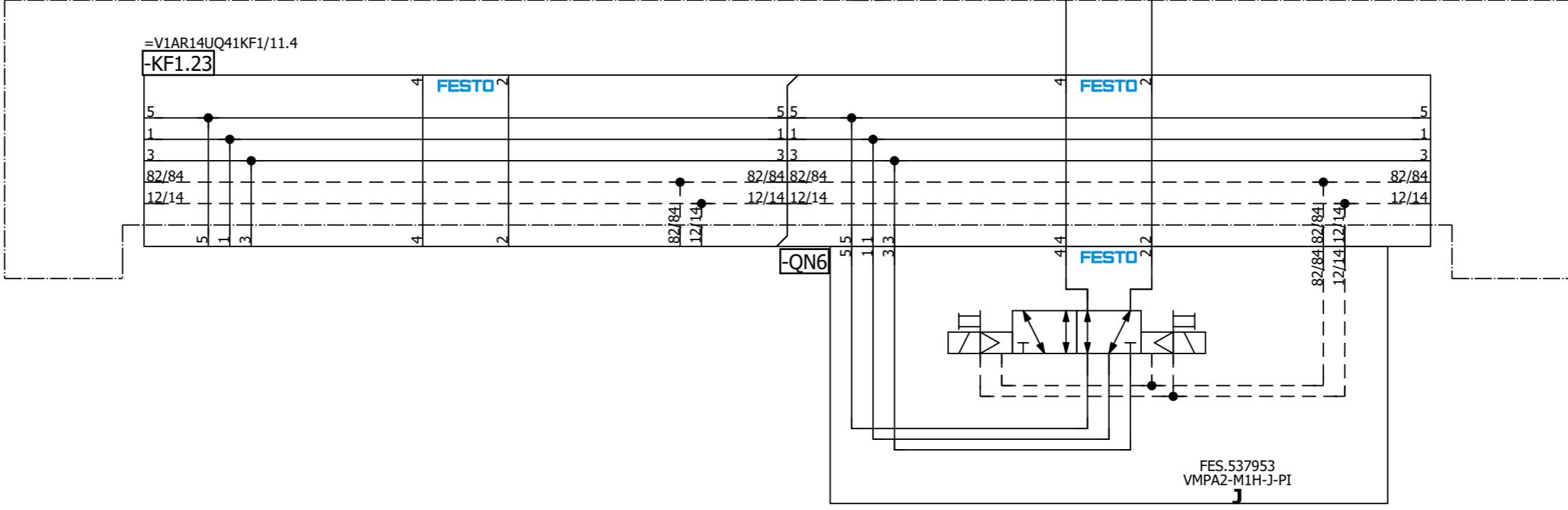

=V1AR14UQ41  
-UQ6-QN6.1  
Common  
Clamps (RST)

=V1AR14UQ41  
-UQ6-QN6.2  
Common  
Clamps (SET)

=V1AR14UQ41UQ5/1

=V1AR14UQ41UQ7/1

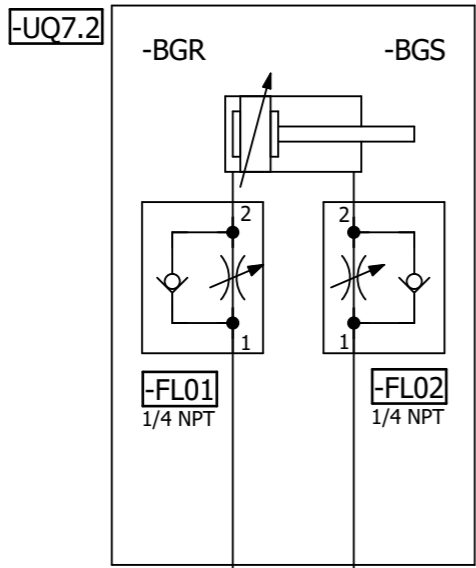
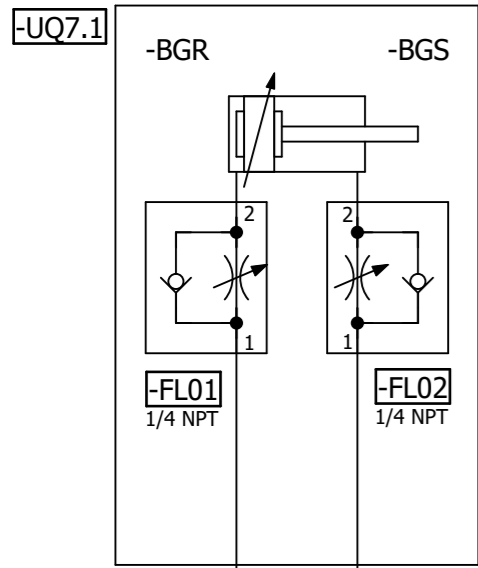

=V1AR14UQ41KF1

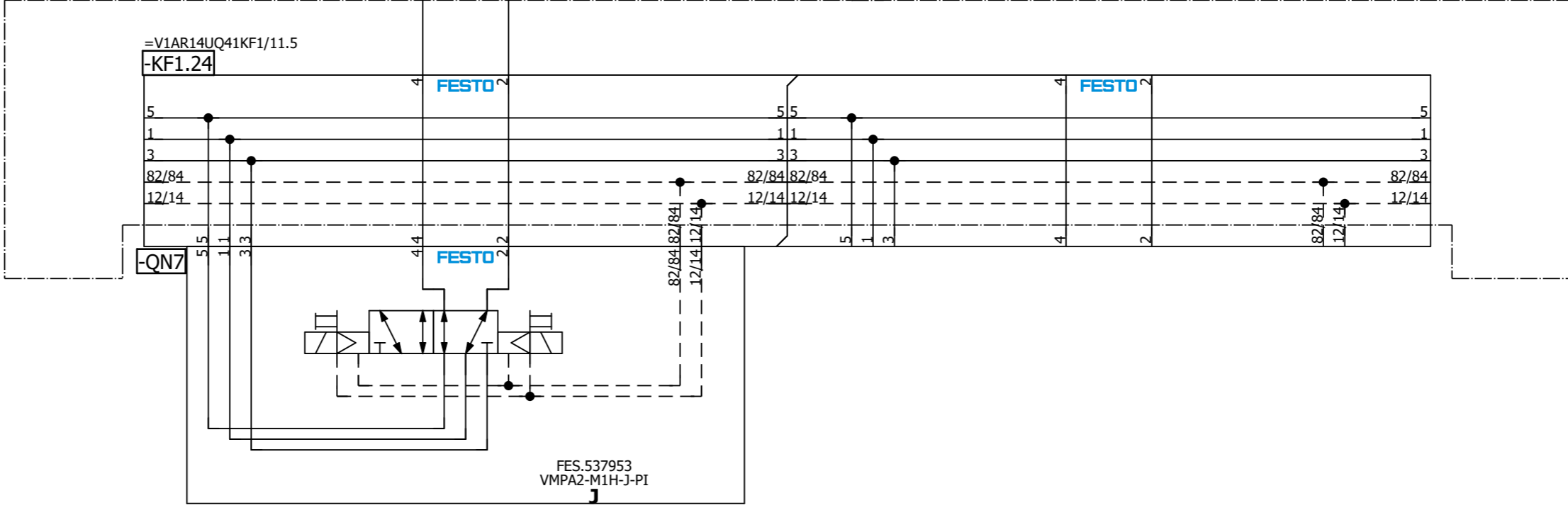

=V1AR14UQ41  
-UQ7-QN7.1  
L150 Model  
Clamps (RST)

=V1AR14UQ41  
-UQ7-QN7.2  
L150 Model  
Clamps (SET)

=V1AR14UQ41UQ6/1

=V1AR14UQ41UQ8/1

Date: 12/21/2022		Volvo Trucks North America		Valiant TMS		Drawing name: =2V04&MFS-PNEU		= V1AR14UQ41UQ7	
Ed.: MKLEPADLO		P6700 Underbody Mainline - Cell 2V04		L150 Model Clamps		Document type: MFS		+ V1AR14UQ41	
Appr:		Replacement of		Replaced by		Project nr: 22-16151		Page 1	
Original								227	

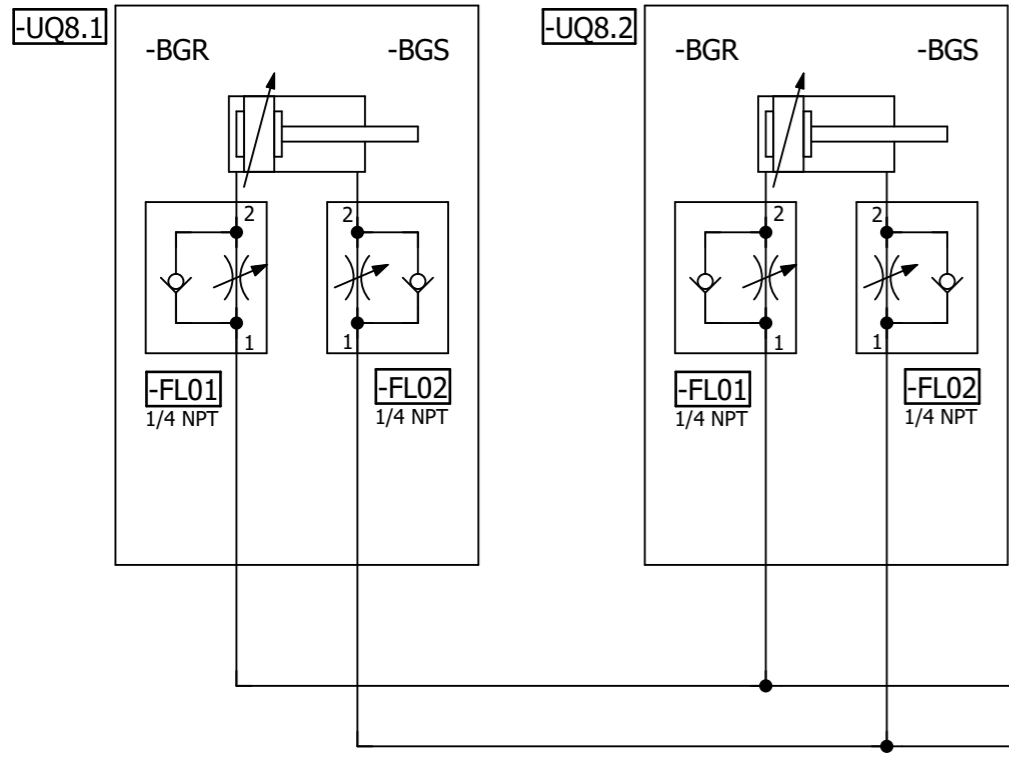

=V1AR14UQ41KF1

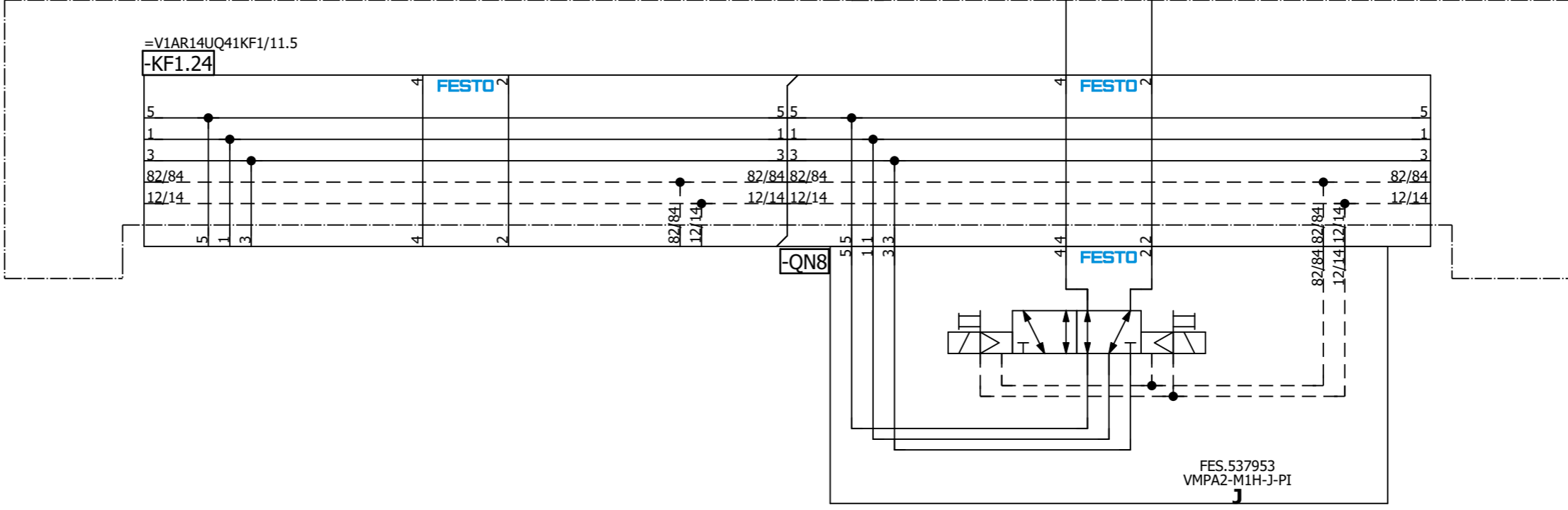

=V1AR14UQ41  
-UQ8-QN8.1  
L230 Model  
Clamps (RST)

=V1AR14UQ41  
-UQ8-QN8.2  
L230 Model  
Clamps (SET)

FES.537953  
VMPA2-M1H-J-PI

=V1AR14UQ41UQ7/1

=V1AR14UQ41UQ9/1

Date: 12/21/2022		Volvo Trucks North America		Valiant TMS		L230 Model Clamps		Drawing name: =2V04&MFS-PNEU		= V1AR14UQ41UQ8	
Ed.: MKLEPADLO		P6700 Underbody Mainline - Cell 2V04		Scale 1:1				Document type: MFS		+ V1AR14UQ41	
Appr:		Replacement of		Replaced by				Project nr: 22-16151		Page 1	
Original										227	



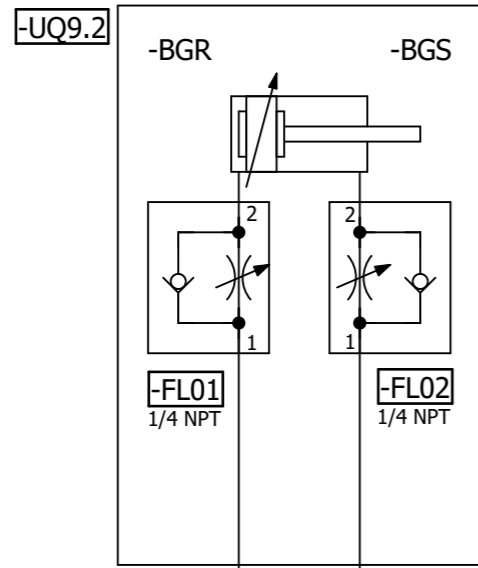
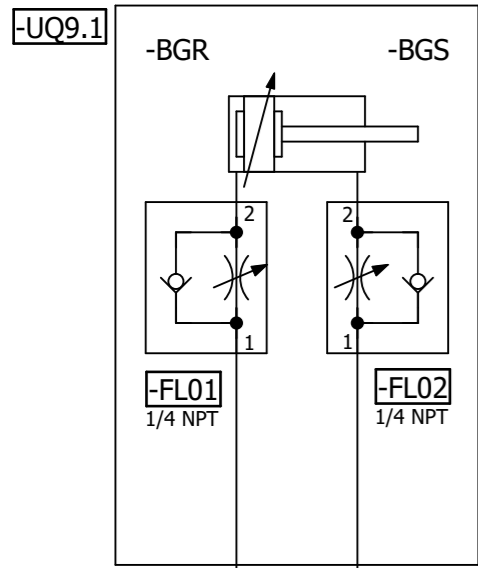

=V1AR14UQ41KF1

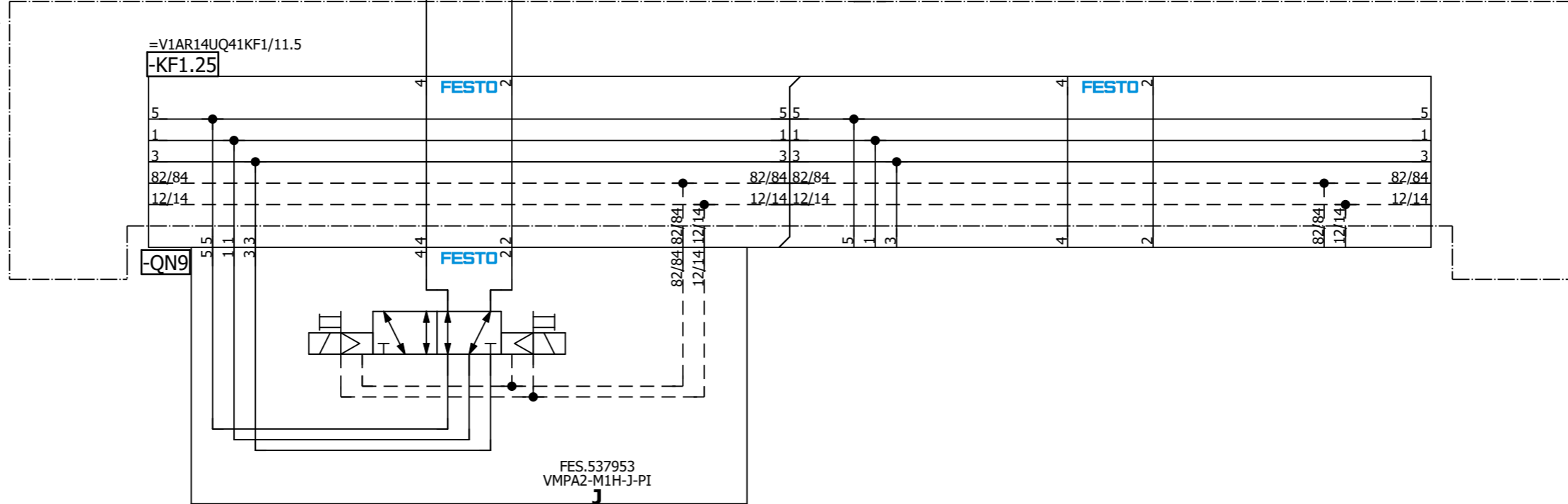

=V1AR14UQ41  
 -UQ9-QN9.1  
 L290 Model  
 Clamps (RST)

=V1AR14UQ41  
 -UQ9-QN9.2  
 L290 Model  
 Clamps (SET)

=V1AR14UQ41UQ8/1

=V1AR14UQ41UQ10/1

Date: 12/21/2022		Volvo Trucks North America		Valiant TMS		L290 Model Clamps		Drawing name: =2V04&MFS-PNEU		= V1AR14UQ41UQ9	
Ed.: MKLEPADLO		P6700 Underbody Mainline - Cell 2V04		Scale 1:1				Document type: MFS		+ V1AR14UQ41	
Appr:		Replacement of		Replaced by				Project nr: 22-16151		Page 1	
Original										227	



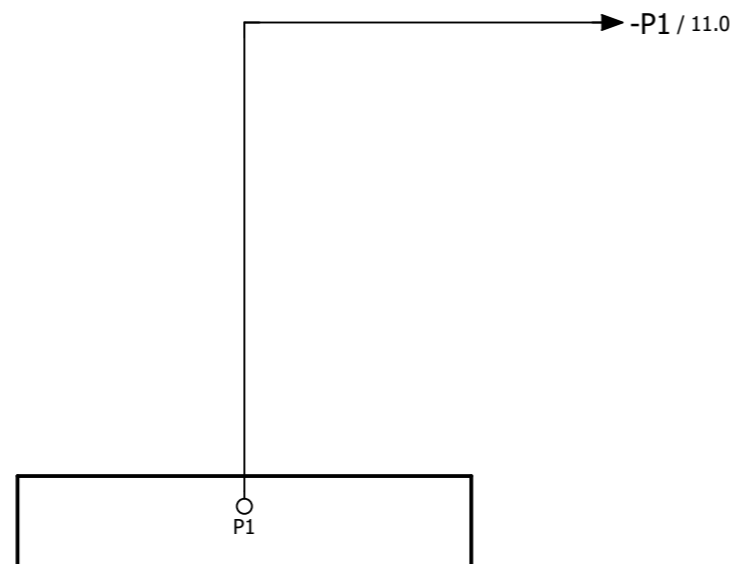

=V1AR14UQ41UQ10+.AR14UQ41/1

		Date	12/21/2022	Volvo Trucks North America			Valiant TMS	AIR SUPPLY GRIPPER	Drawing name:		= V1AR15UQ41KF1
		Ed.	MKLEPADLO	P6700 Underbody Mainline - Cell 2V04					=2V04&MFS-PNEU		+ V1AR15UQ41
		Appr		Replacement of		Replaced by	Scale 1:1		Document type:	Project nr:	Page
Modification	Date	Name	Original						MFS	22-16151	1
											227

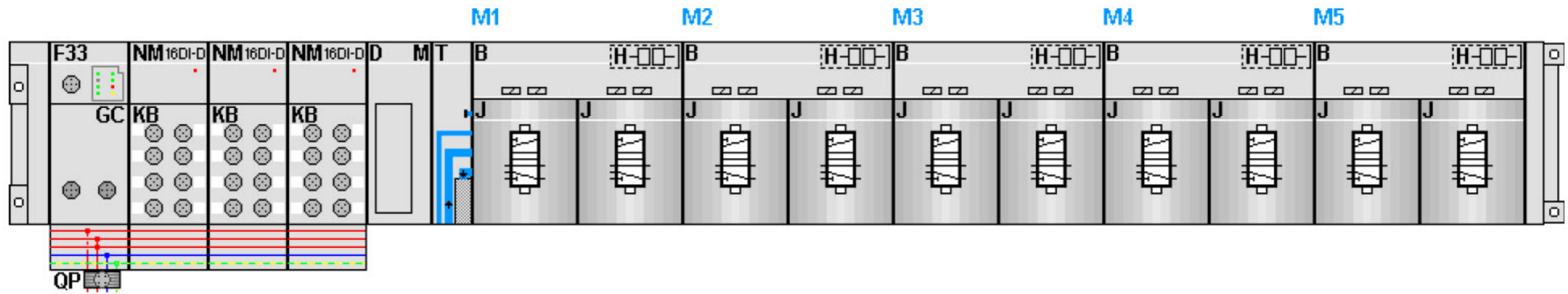

KF1.0

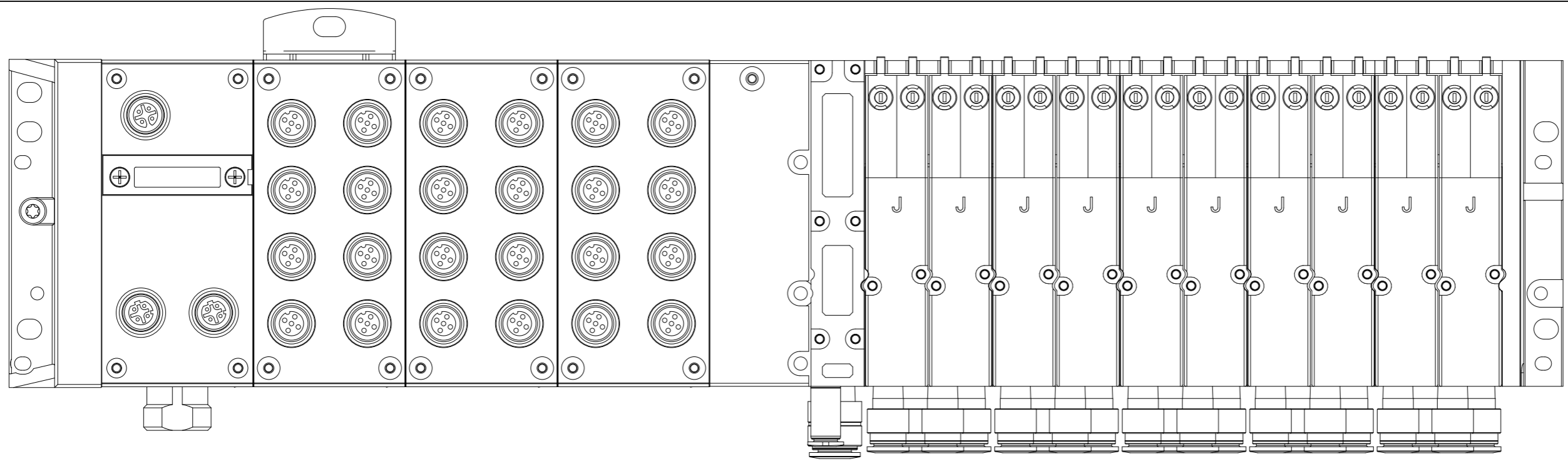

Date		12/21/2022	Volvo Trucks North America		Valiant TMS	AIR SUPPLY	Drawing name:		= V1AR15UQ41KF1
Ed.		MKLEPADLO	P6700 Underbody Mainline - Cell 2V04				= 2V04&MFS-PNEU		+ V1AR15UQ41
Appr			Replacement of		Scale 1:1		Document type:	Project nr:	Page
Modification	Date	Name	Original	Replaced by			MFS	22-16151	5

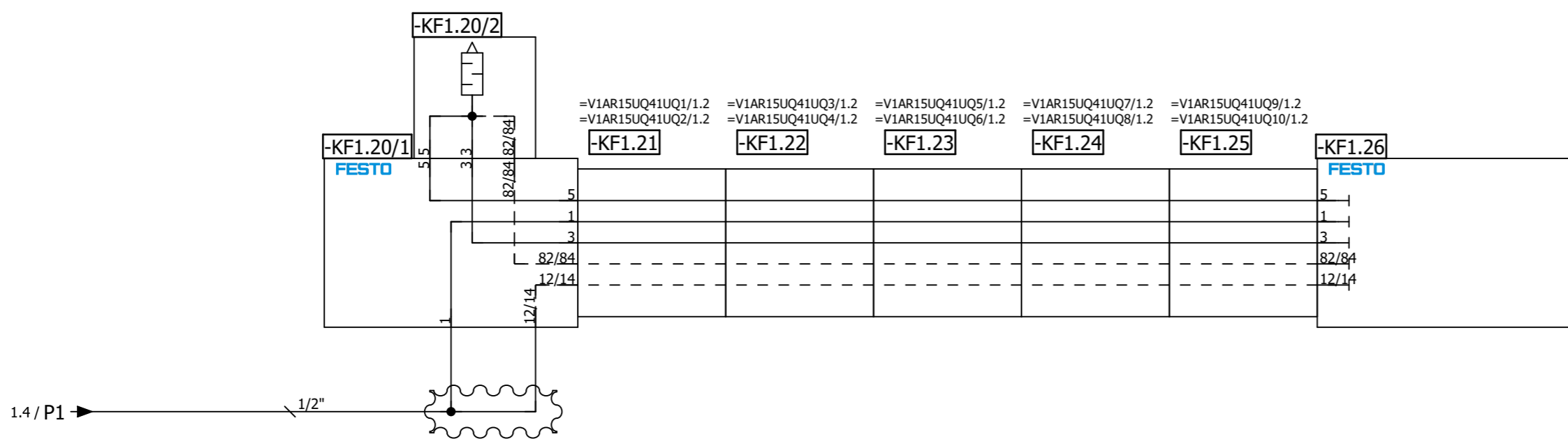
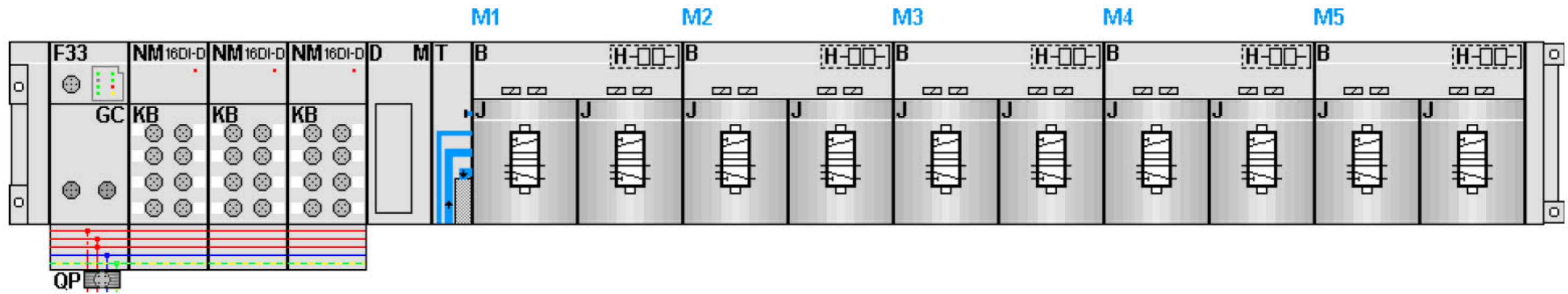

Date		12/21/2022	Volvo Trucks North America		Valiant TMS	AIR SUPPLY	Drawing name:		= V1AR15UQ41KF1			
Ed.		MKLEPADLO	P6700 Underbody Mainline - Cell 2V04				=2V04&MFS-PNEU		+ V1AR15UQ41			
Appr			Replacement of		Scale 1:1	Document type:		MFS	Project nr:	22-16151	Page	11
Original			Replaced by									227

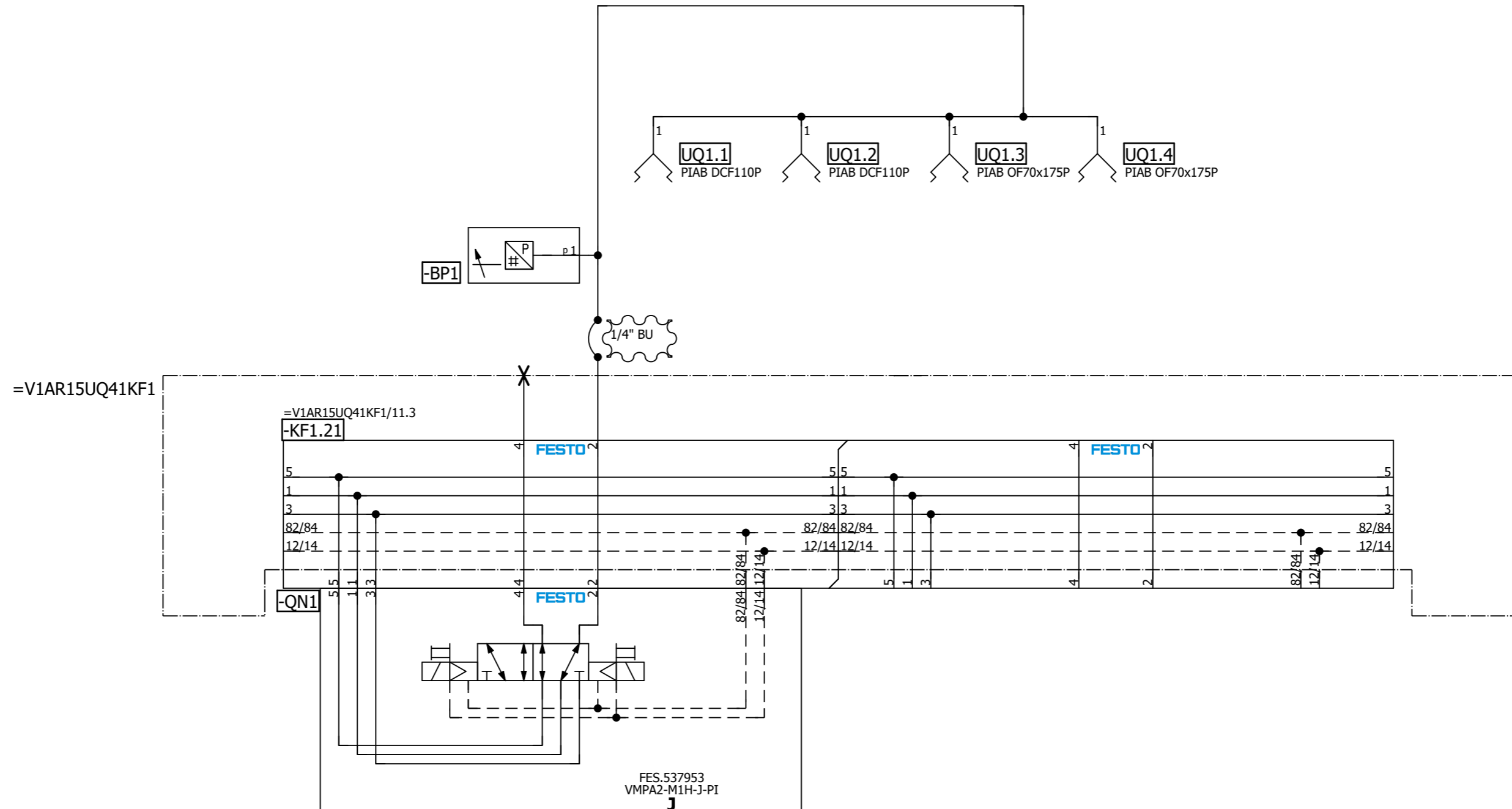

=V1AR15UQ41  
-UQ1-QN1.1  
Common  
Vacuums (RST)

=V1AR15UQ41  
-UQ1-QN1.2  
Common  
Vacuums (SET)

=V1AR15UQ41KF1/11

=V1AR15UQ41UQ2/1

Date		12/21/2022	Volvo Trucks North America		Valiant TMS		Common Vacuums		Drawing name:		= V1AR15UQ41UQ1	
Ed.		MKLEPADLO	P6700 Underbody Mainline - Cell 2V04		Scale 1:1				=2V04&MFS-PNEU		+ V1AR15UQ41	
Appr.			Replacement of		Replaced by				Document type:		Project nr:	
Original									MFS		22-16151	
Modification		Date	Name		Original						Page	
											1	
											227	

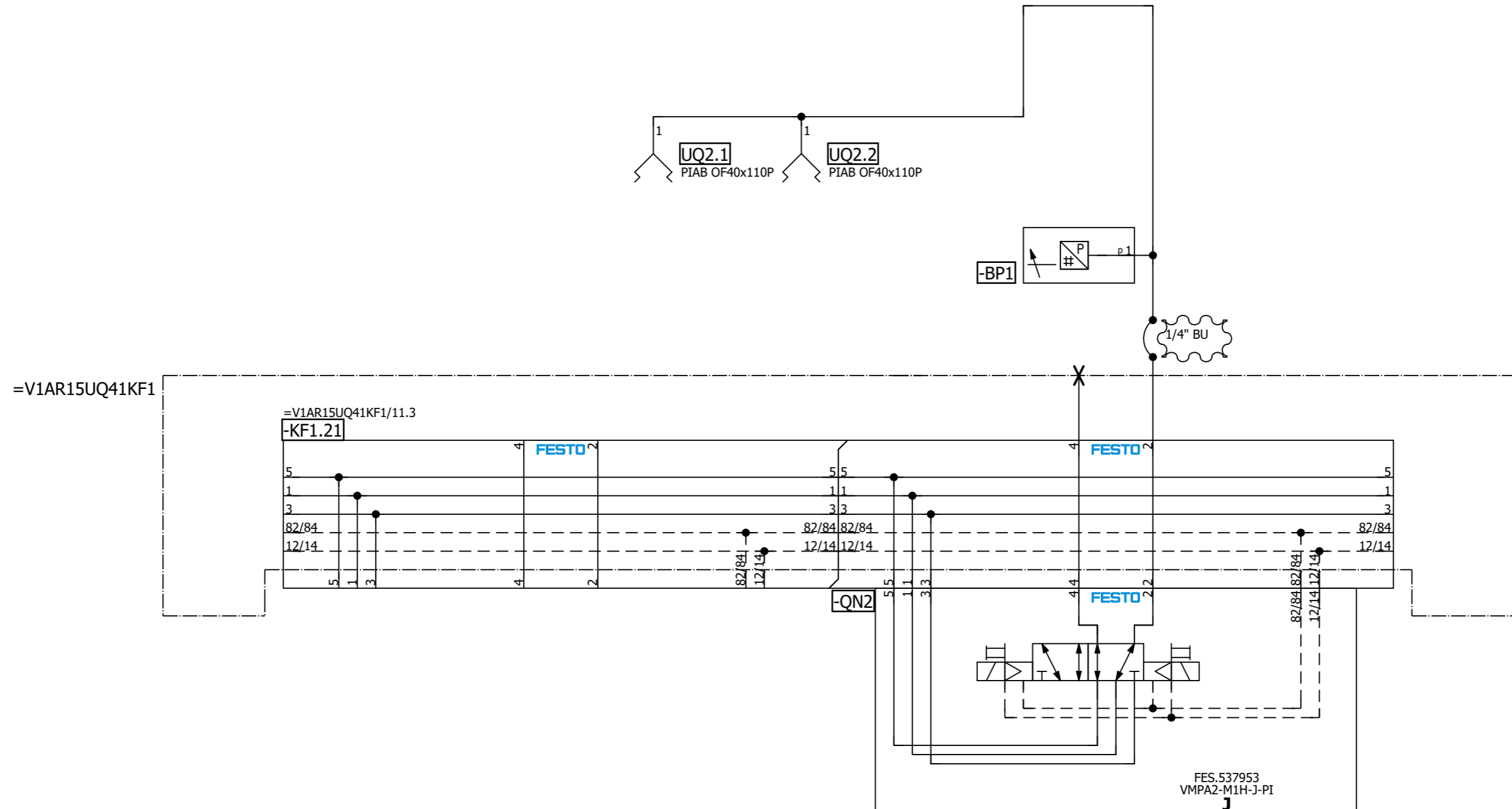

=V1AR15UQ41KF1

=V1AR15UQ41KF1/11.3

-KF1.21

=V1AR15UQ41  
-UQ2-QN2.1  
L230/320 Model  
Vacuums (RST)

=V1AR15UQ41  
-UQ2-QN2.2  
L230/320 Model  
Vacuums (SET)

=V1AR15UQ41UQ3/1

=V1AR15UQ41UQ1/1

Date		12/21/2022		Volvo Trucks North America		Valiant TMS		L230/320 Model Vacuums		Drawing name:		= V1AR15UQ41UQ2	
Ed.		MKLEPADLO		P6700 Underbody Mainline - Cell 2V04		Scale 1:1				=2V04&MFS-PNEU		+ V1AR15UQ41	
Appr.				Replacement of		Replaced by				Document type:		Project nr:	
Original										MFS		22-16151	
Modification		Date		Name		Original						Page	
												1	
												227	



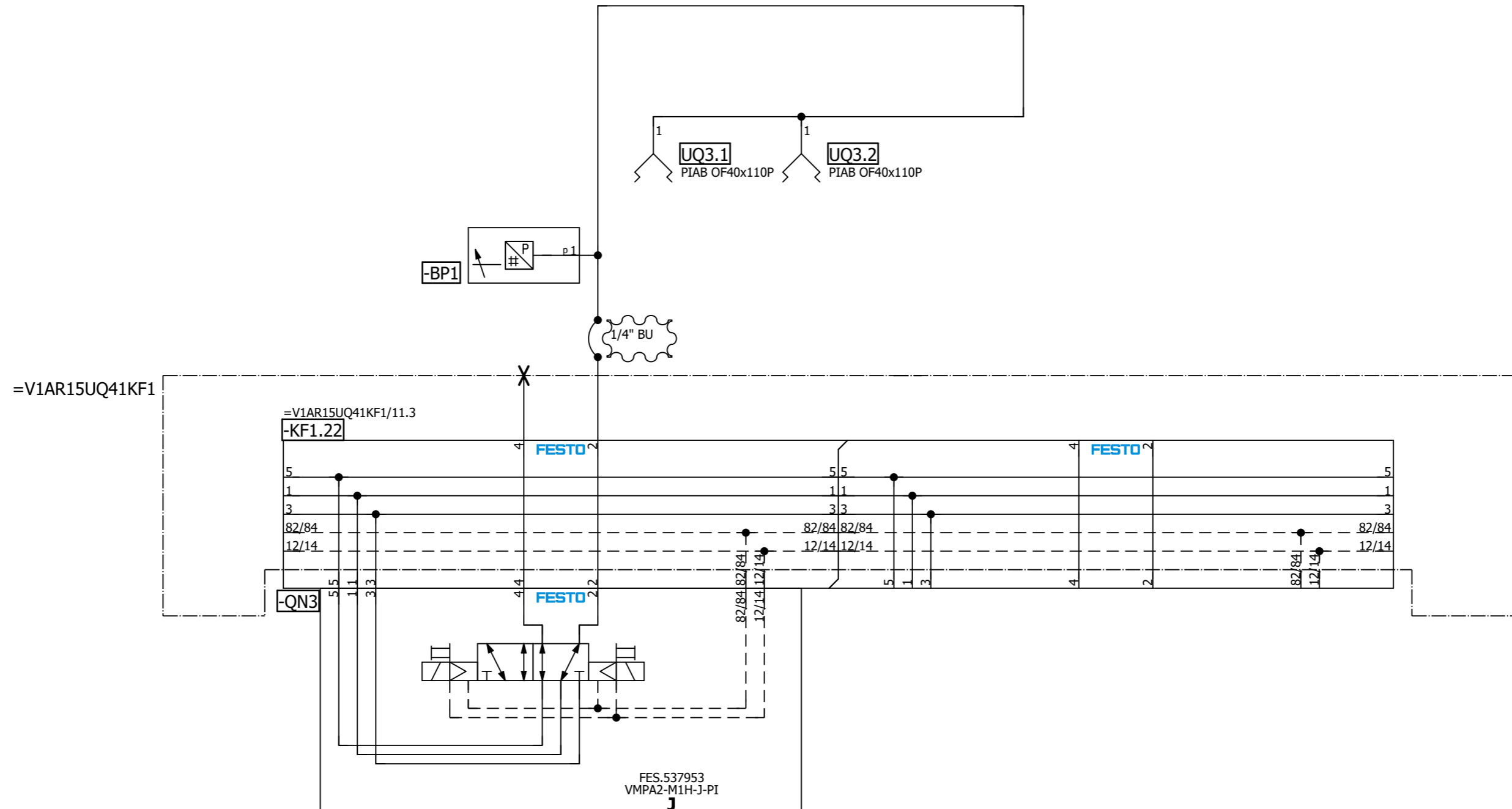

=V1AR15UQ41  
-UQ3-QN3.1  
L290 Model  
Vacuums (RST)

=V1AR15UQ41  
-UQ3-QN3.2  
L290 Model  
Vacuums (SET)

=V1AR15UQ41UQ2/1

=V1AR15UQ41UQ4/1

Date		12/21/2022	Volvo Trucks North America		Valiant TMS		L290 Model Vacuums		Drawing name:		= V1AR15UQ41UQ3	
Ed.		MKLEPADLO	P6700 Underbody Mainline - Cell 2V04		Scale 1:1				=2V04&MFS-PNEU		+ V1AR15UQ41	
Appr.			Replacement of		Replaced by				Document type:		Project nr:	
Original									MFS		22-16151	
Modification		Date	Name		Original						Page	
											1	
											227	





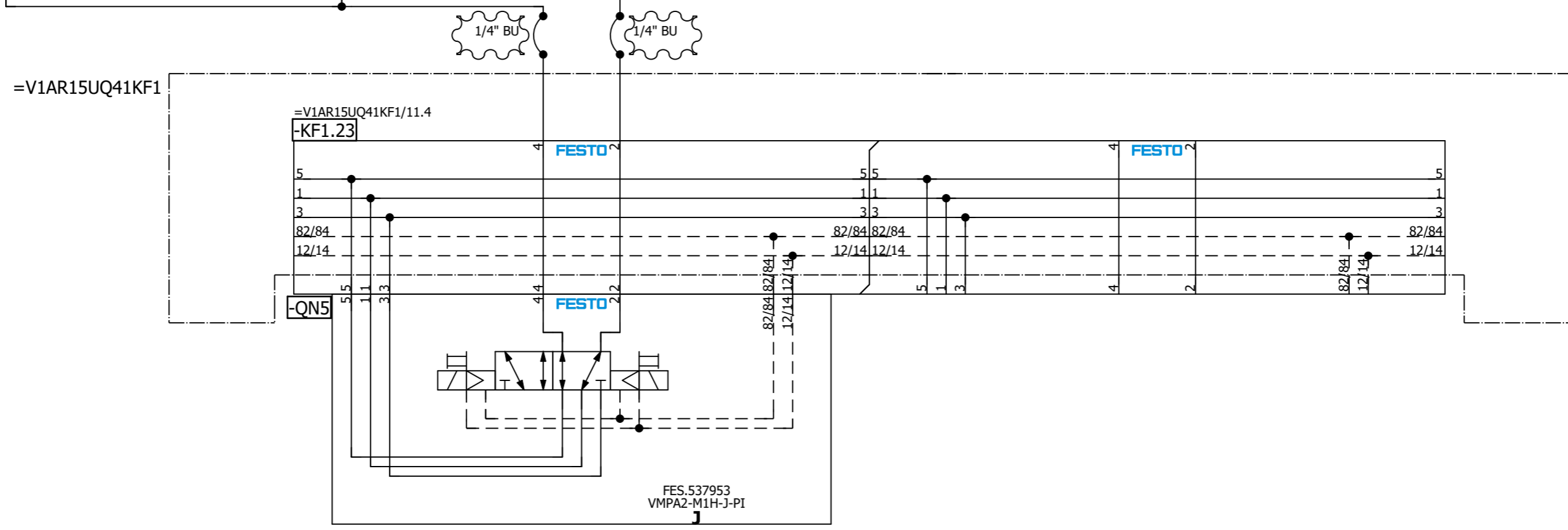
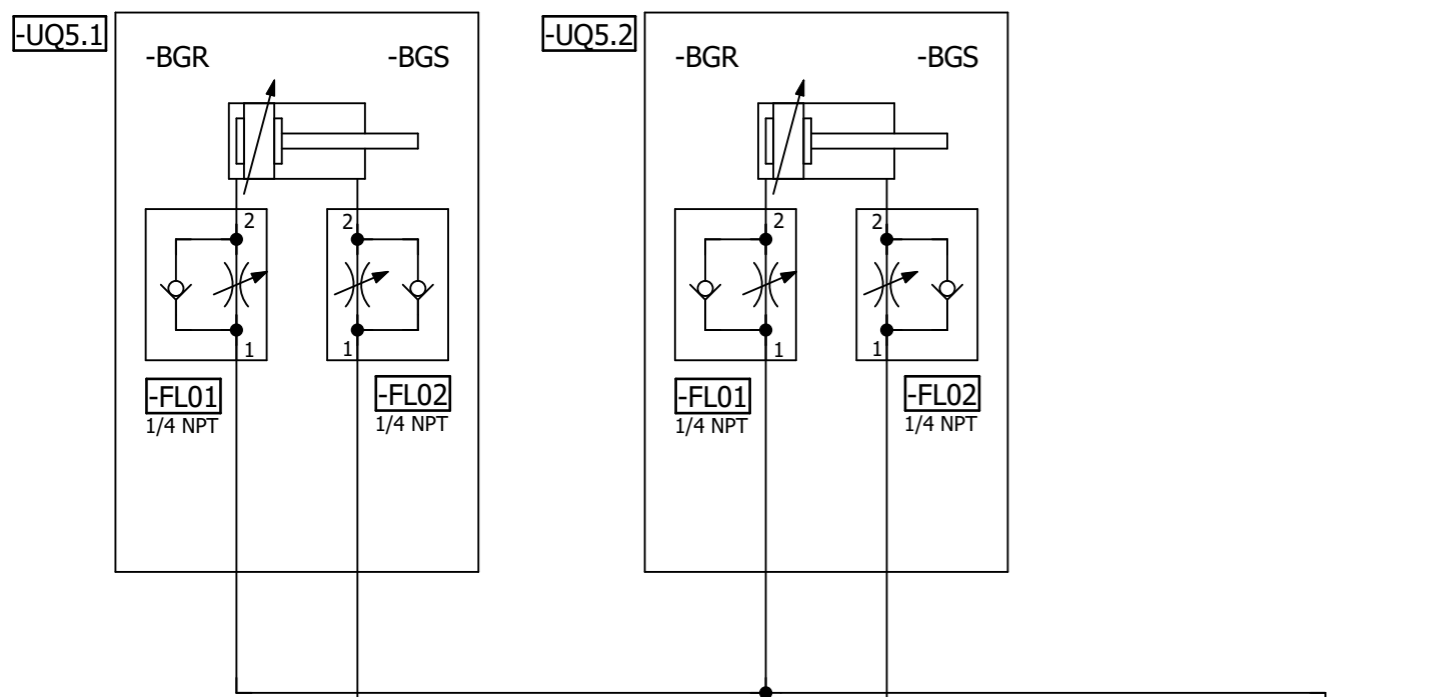

=V1AR15UQ41  
-UQ5-QN5.1  
Common  
Clamps (RST)

=V1AR15UQ41  
-UQ5-QN5.2  
Common  
Clamps (SET)

=V1AR15UQ41UQ4/1

=V1AR15UQ41UQ6/1

Date		12/21/2022	Volvo Trucks North America		Valiant TMS	Common Clamps	Drawing name:		= V1AR15UQ41UQ5
Ed.		MKLEPADLO	P6700 Underbody Mainline - Cell 2V04				=2V04&MFS-PNEU		+ V1AR15UQ41
Appr.			Replacement of		Scale 1:1		Document type:		MFS
Original			Replaced by				Project nr:		22-16151
Modification	Date	Name	Original				Page		1
									227

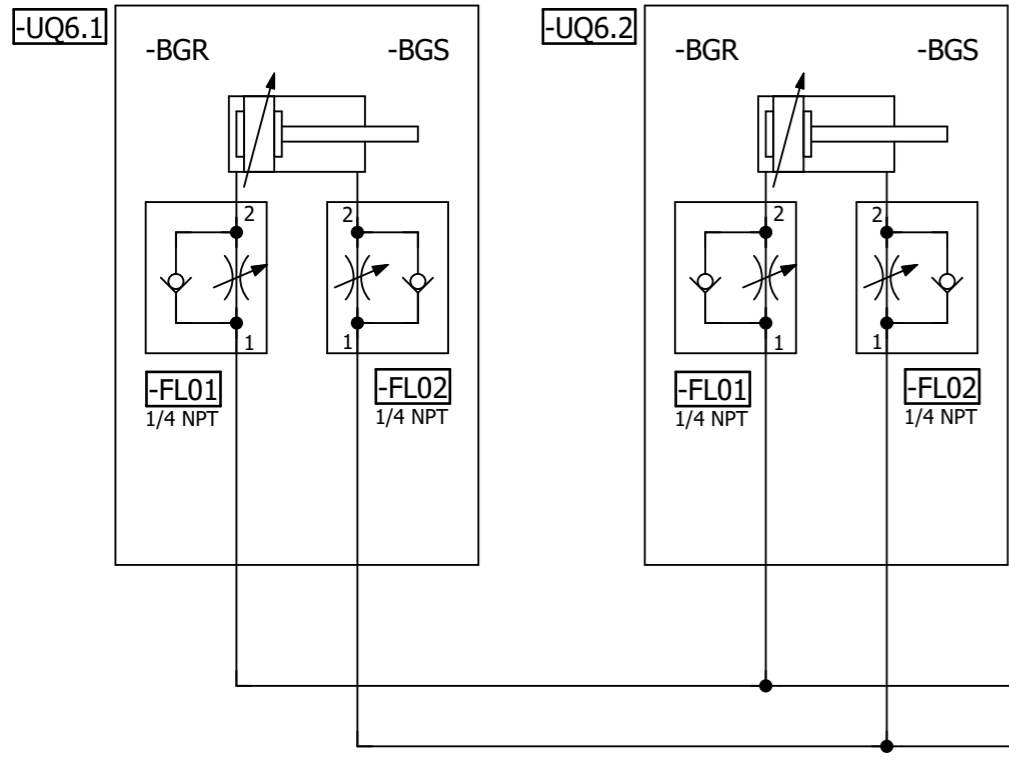

=V1AR15UQ41KF1

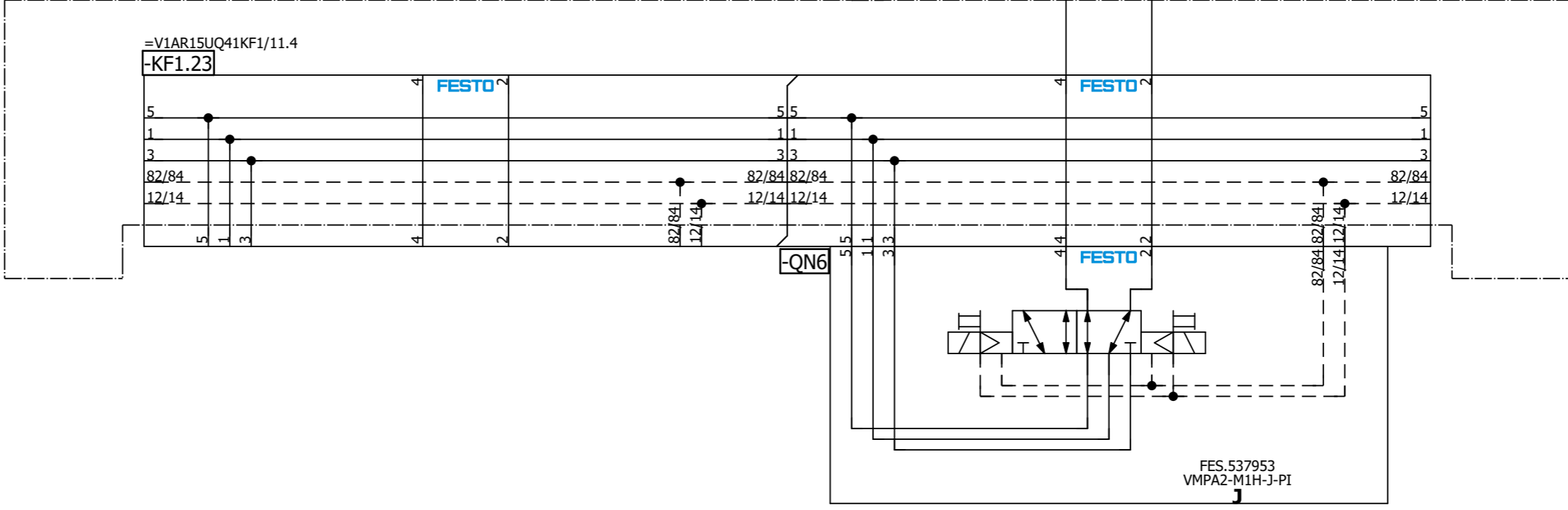

=V1AR15UQ41  
-UQ6-QN6.1  
L150 Model  
Clamps (RST)

=V1AR15UQ41  
-UQ6-QN6.2  
L150 Model  
Clamps (SET)

=V1AR15UQ41UQ5/1

=V1AR15UQ41UQ7/1

		Date	12/21/2022	Volvo Trucks North America		Valiant TMS		L150 Model Clamps		Drawing name: =2V04&MFS-PNEU		= V1AR15UQ41UQ6	
		Ed.	MKLEPADLO	P6700 Underbody Mainline - Cell 2V04		Scale 1:1				Document type: MFS		Project nr: 22-16151	
Modification	Date	Name	Original	Replacement of	Replaced by					Page		1	
												227	

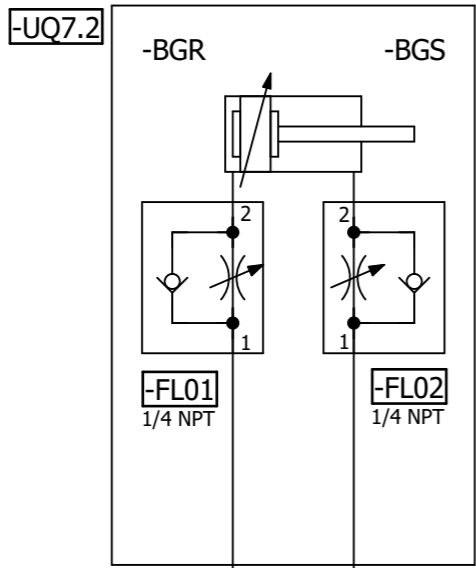
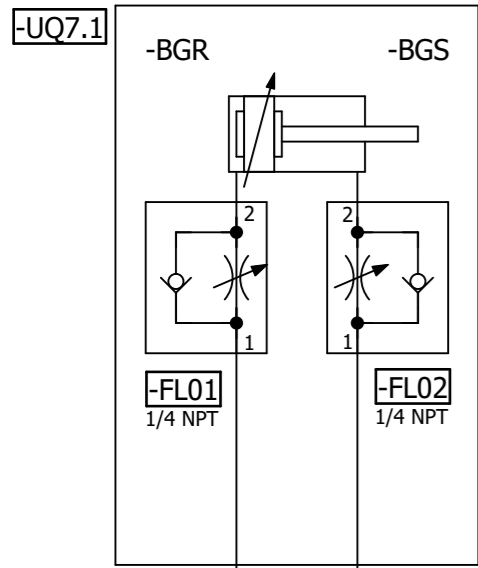

=V1AR15UQ41KF1

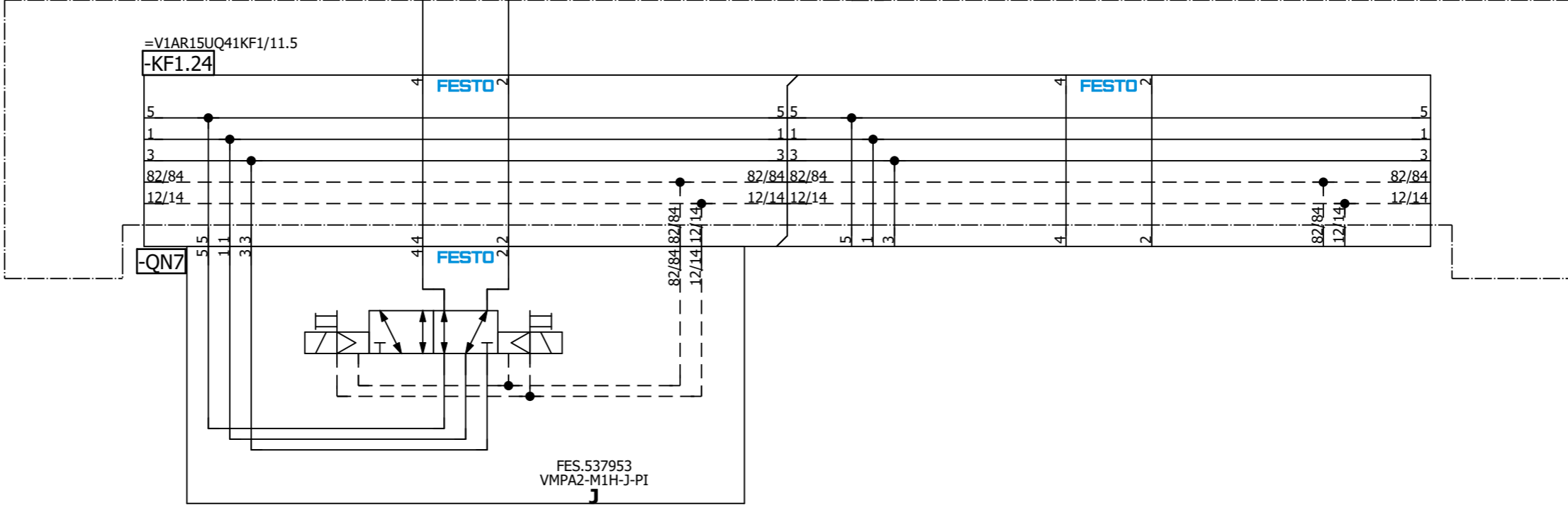

=V1AR15UQ41  
-UQ7-QN7.1  
L230 Model  
Clamps (RST)

=V1AR15UQ41  
-UQ7-QN7.2  
L230 Model  
Clamps (SET)

=V1AR15UQ41UQ6/1

=V1AR15UQ41UQ8/1

Date: 12/21/2022		Volvo Trucks North America		Valiant TMS		Drawing name: =2V04&MFS-PNEU		= V1AR15UQ41UQ7	
Ed.: MKLEPADLO		P6700 Underbody Mainline - Cell 2V04		L230 Model Clamps		Document type: MFS		+ V1AR15UQ41	
Appr:		Replacement of		Replaced by		Project nr: 22-16151		Page 1	
Original								227	

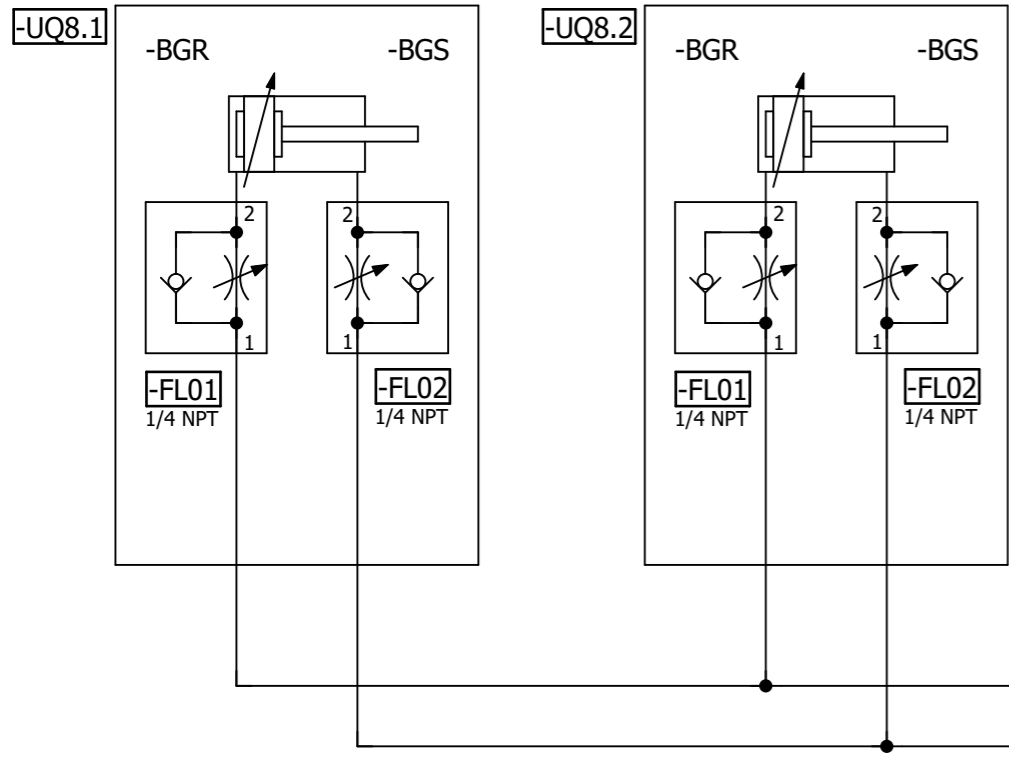

=V1AR15UQ41KF1

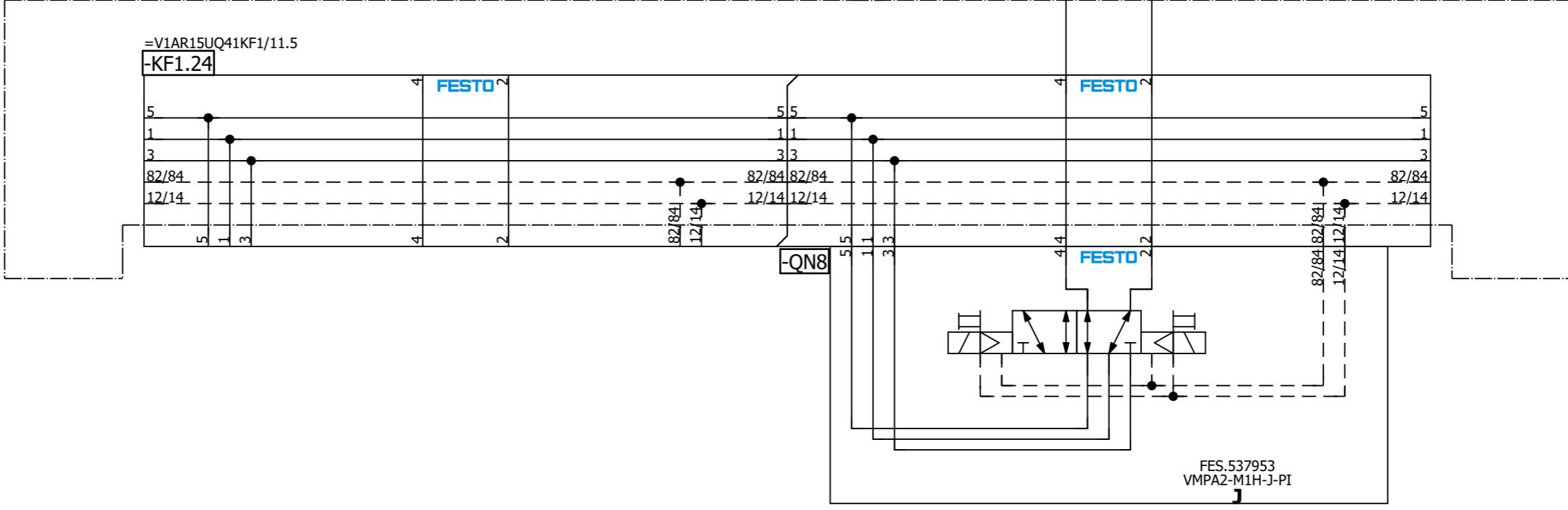

=V1AR15UQ41  
-UQ8-QN8.1  
L290 Model  
Clamps (RST)

=V1AR15UQ41  
-UQ8-QN8.2  
L290 Model  
Clamps (SET)

=V1AR15UQ41UQ7/1

=V1AR15UQ41UQ9/1

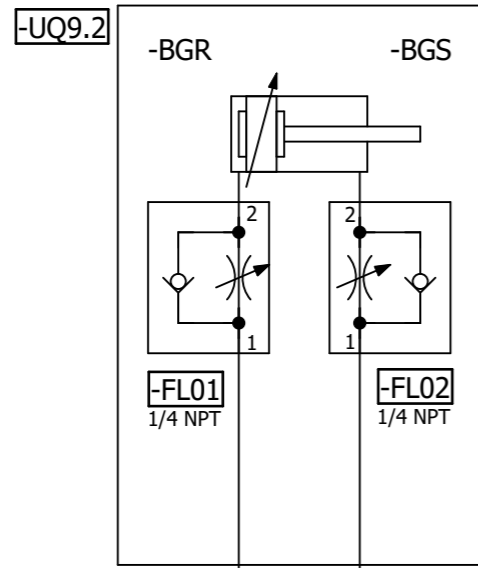
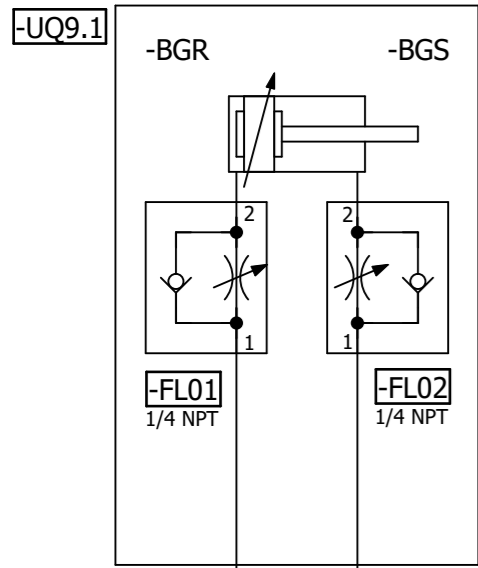

=V1AR15UQ41KF1

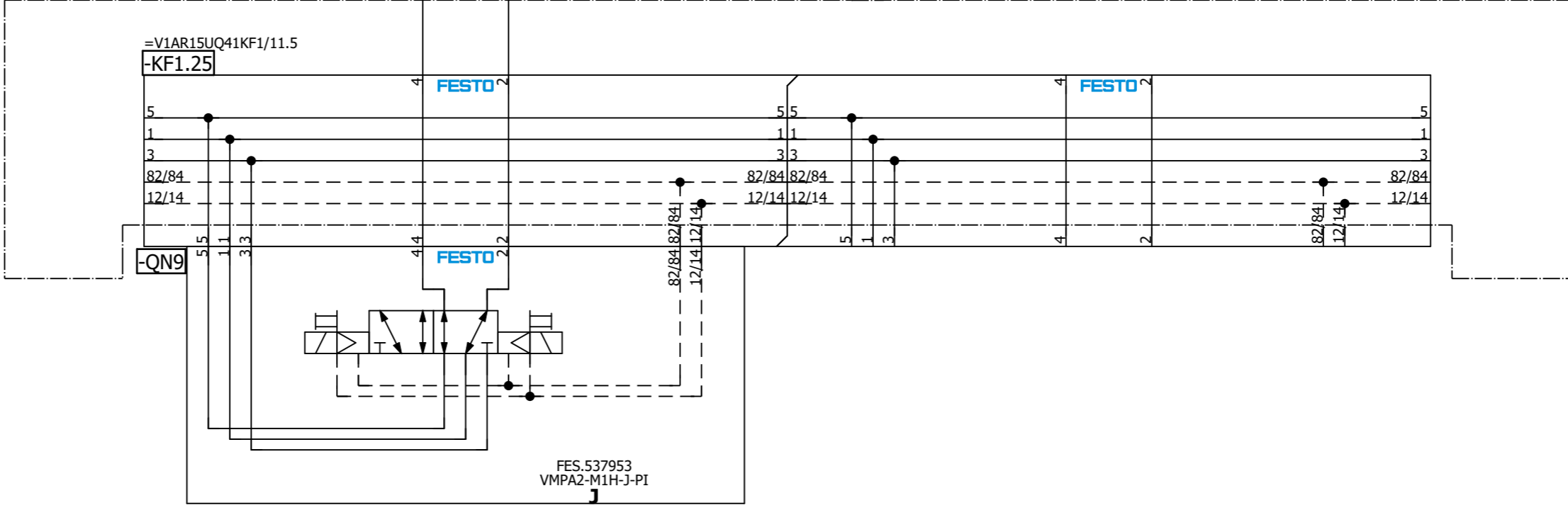

=V1AR15UQ41  
 -UQ9-QN9.1  
 L320 Model  
 Clamps (RST)

=V1AR15UQ41  
 -UQ9-QN9.2  
 L320 Model  
 Clamps (SET)

=V1AR15UQ41UQ8/1

=V1AR15UQ41UQ10/1

Date: 12/21/2022		Volvo Trucks North America		Valiant TMS		L320 Model Clamps		Drawing name: =2V04&MFS-PNEU		= V1AR15UQ41UQ9	
Ed.: MKLEPADLO		P6700 Underbody Mainline - Cell 2V04		Scale 1:1				Document type: MFS		+ V1AR15UQ41	
Appr:		Replacement of		Replaced by				Project nr: 22-16151		Page 1	
Original										227	







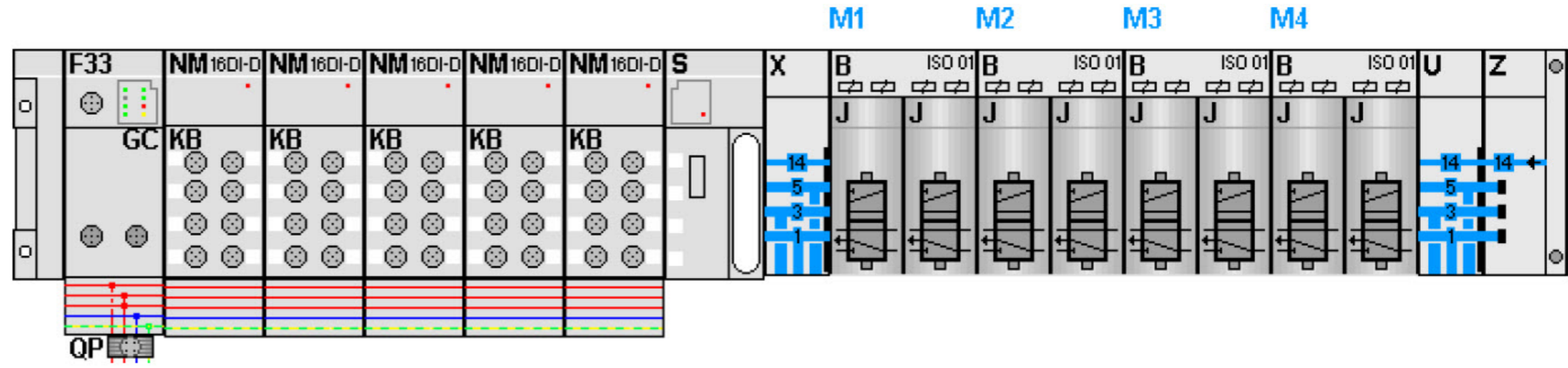

KF2.0

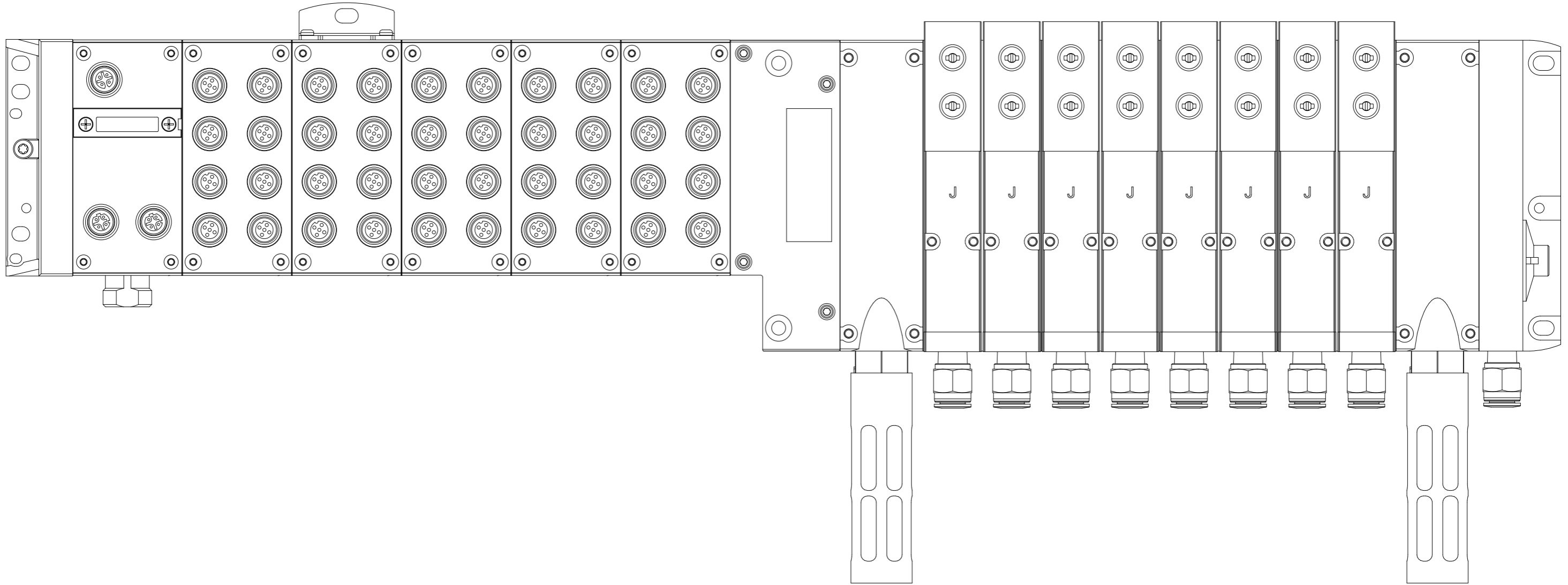

=V1GL11+KH1/1

Date		12/21/2022	Volvo Trucks North America			Valiant TMS		AIR SUPPLY CONFIGURATION		Drawing name:		= V1GL11UQ51KF2		
Ed.		MKLEPADLO	P6700 Underbody Mainline - Cell 2V04			Scale 1:1				Document type:		= 2V04&MFS-PNEU		
Appr			Replacement of		Replaced by				Project nr:		22-16151	Page	5	
Modification		Date	Name	Original						Document type:		MFS	Page	5
														227

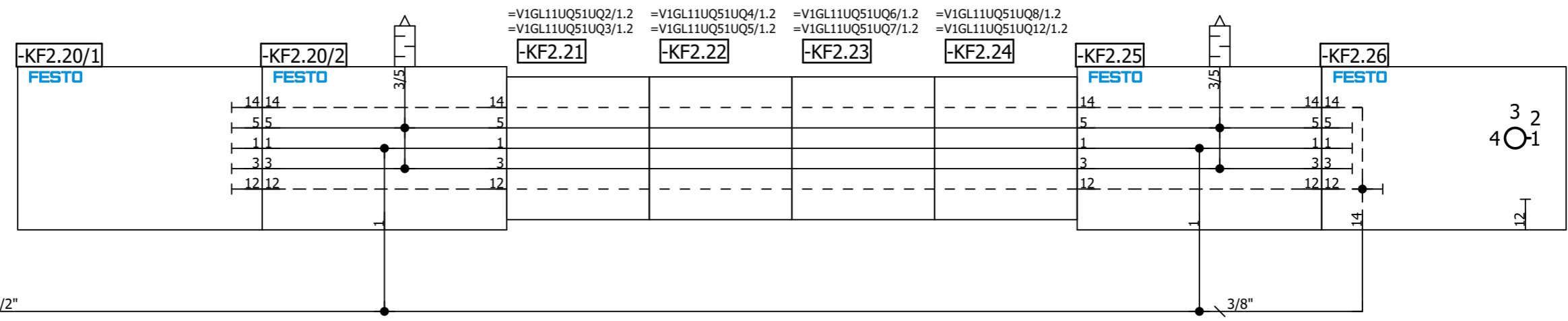
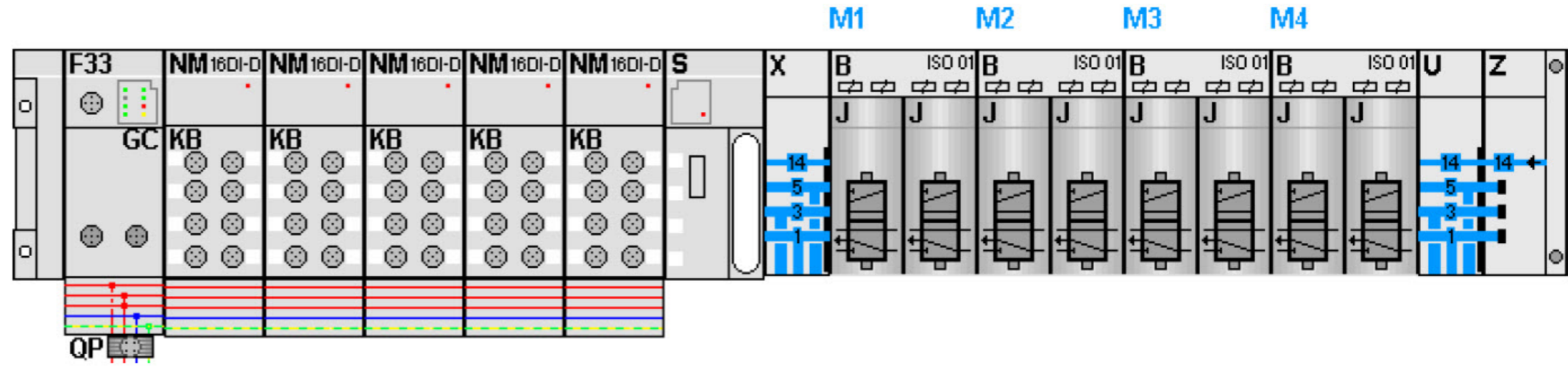

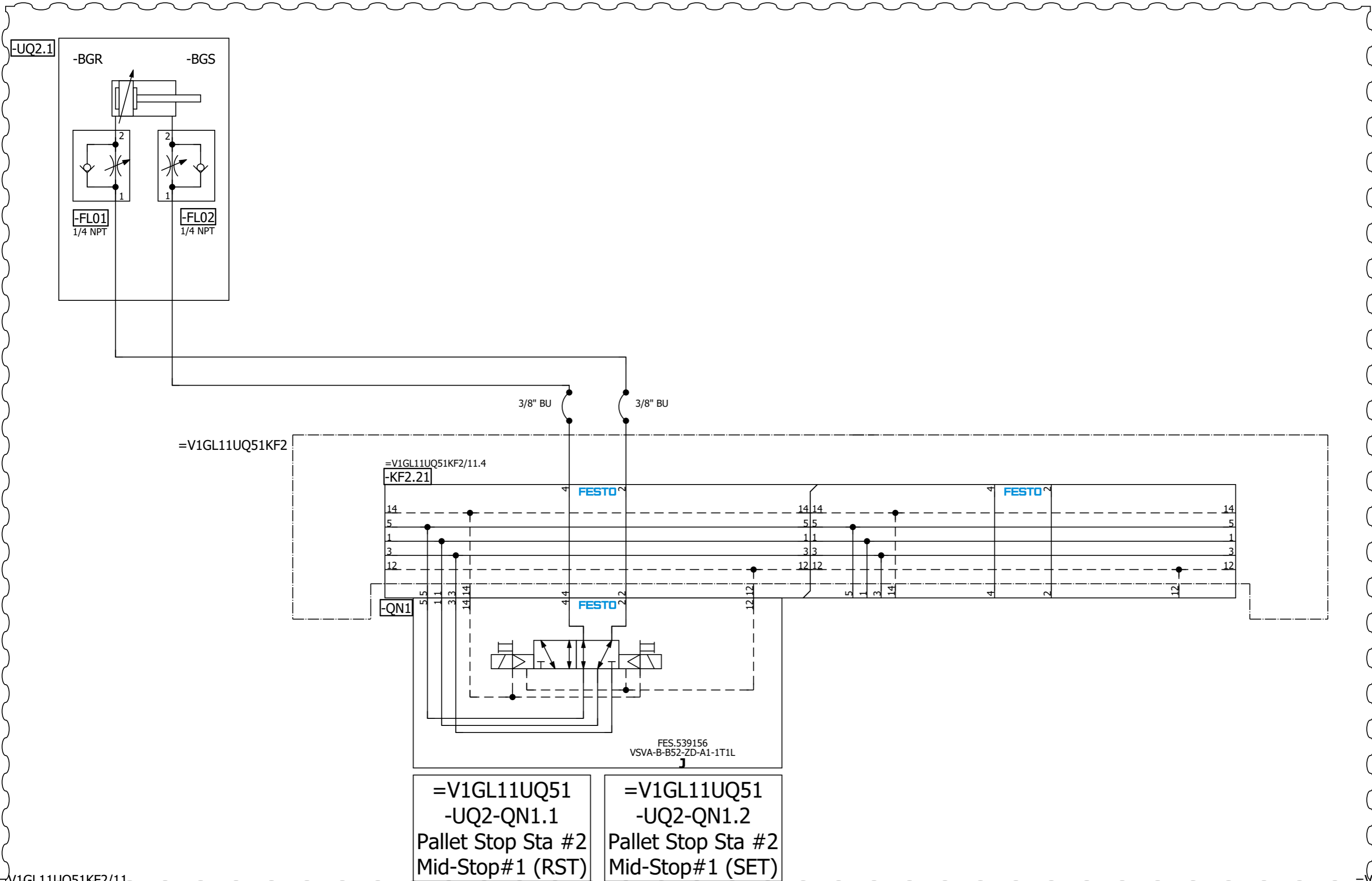

=V1GL11UQ51KF2/11.4      =V1GL11UQ51KF2/11.4      =V1GL11UQ51UQ3/1

Date		12/21/2022		Volvo Trucks North America		Valiant TMS		Pallet Stop Station #2 Mid-Stop #1		Drawing name:		= V1GL11UQ51UQ2	
Ed.		MKLEPADLO		P6700 Underbody Mainline - Cell 2V04		Scale 1:1				Document type:		+ V1GL11UQ51	
Appr		Original		Replacement of		Replaced by				Project nr:		Page	
Modification		Date		Name						22-16151		1	
										MFS		227	

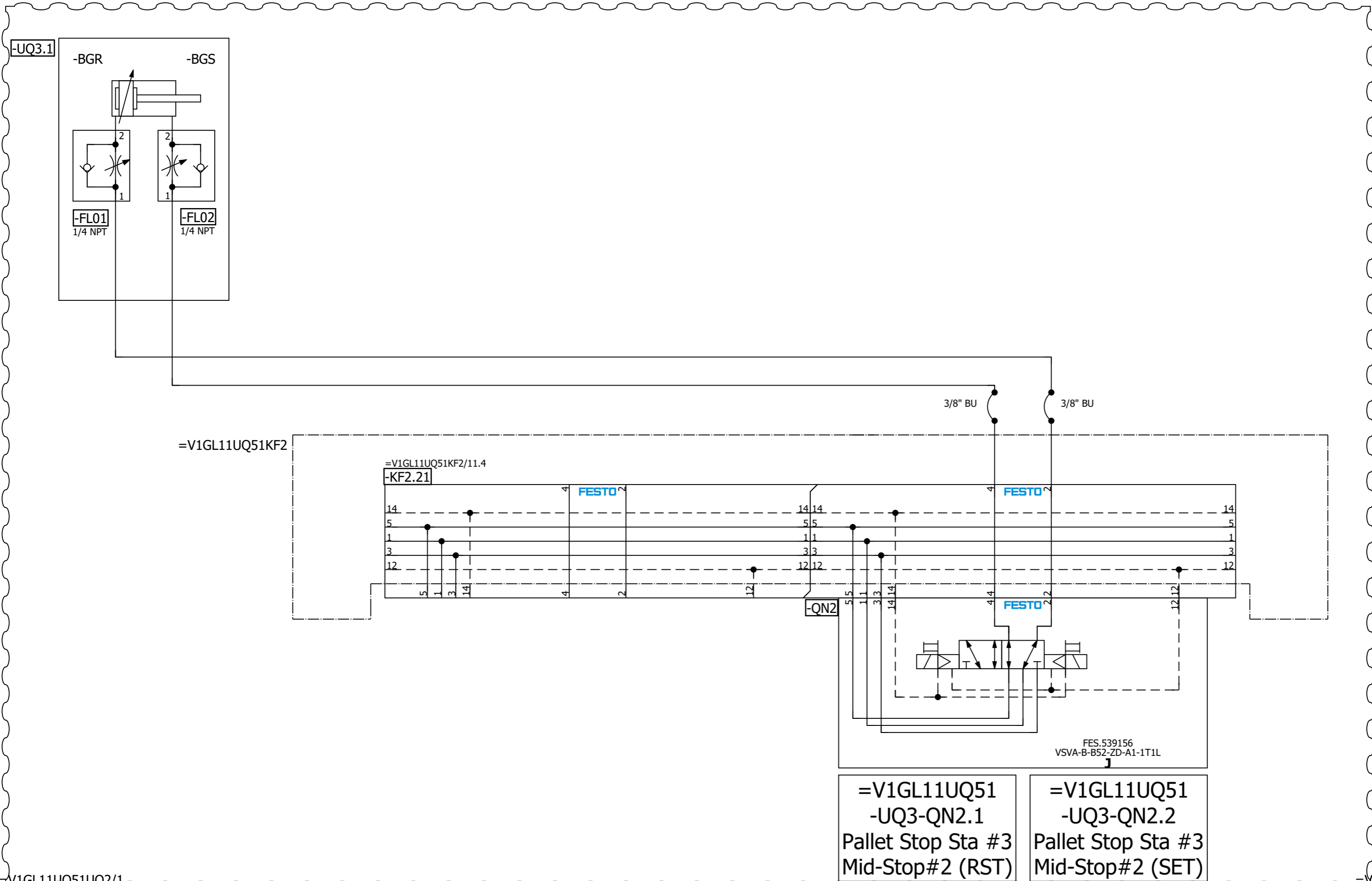

=V1GL11UQ51UQ2/1 =V1GL11UQ51UQ4/1

=V1GL11UQ51  
-UQ3-QN2.1  
Pallet Stop Sta #3  
Mid-Stop#2 (RST)

=V1GL11UQ51  
-UQ3-QN2.2  
Pallet Stop Sta #3  
Mid-Stop#2 (SET)

Modification		Date	Name	Date	12/21/2022	Ed.	MKLEPADLO	Appr.	Original	Volvo Trucks North America	Valiant TMS	Pallet Stop Station #3 Mid-Stop #2	Drawing name:	= V1GL11UQ51UQ3 + V1GL11UQ51	Project nr:	22-16151	Page	1
										Replacement of	Replaced by	Scale 1:1	Document type:	MFS				227

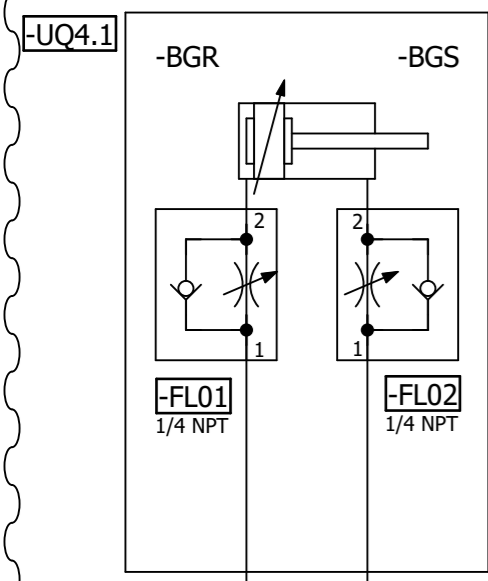

=V1GL11UQ51KF2

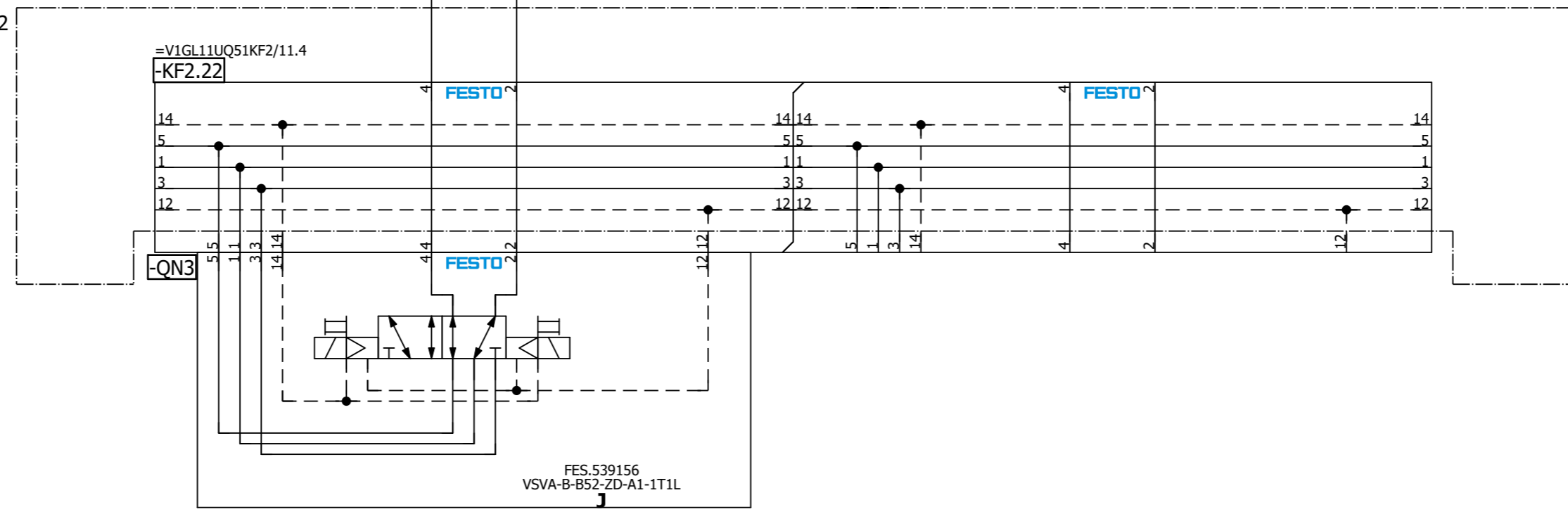

=V1GL11UQ51  
-UQ4-QN3.1  
Pallet Stop Sta #4  
Pre-Unload (RST)

=V1GL11UQ51  
-UQ4-QN3.2  
Pallet Stop Sta #4  
Pre-Unload (SET)

=V1GL11UQ51UQ3/1

=V1GL11UQ51UQ5/1

Date: 12/21/2022		Volvo Trucks North America		Valiant TMS		Pallet Stop Station #4 Pre-Unload		Drawing name: =2V04&MFS-PNEU		= V1GL11UQ51UQ4	
Ed.: MKLEPADLO		P6700 Underbody Mainline - Cell 2V04		Scale 1:1				Document type: MFS		+ V1GL11UQ51	
Appr:		Replacement of		Replaced by				Project nr: 22-16151		Page 1	
Original										227	





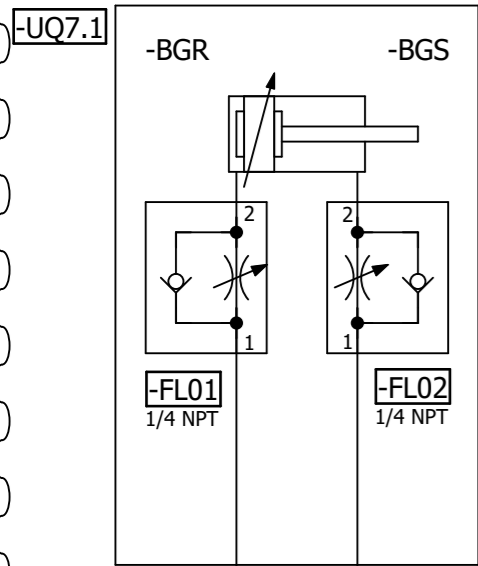

=V1GL11UQ51KF2

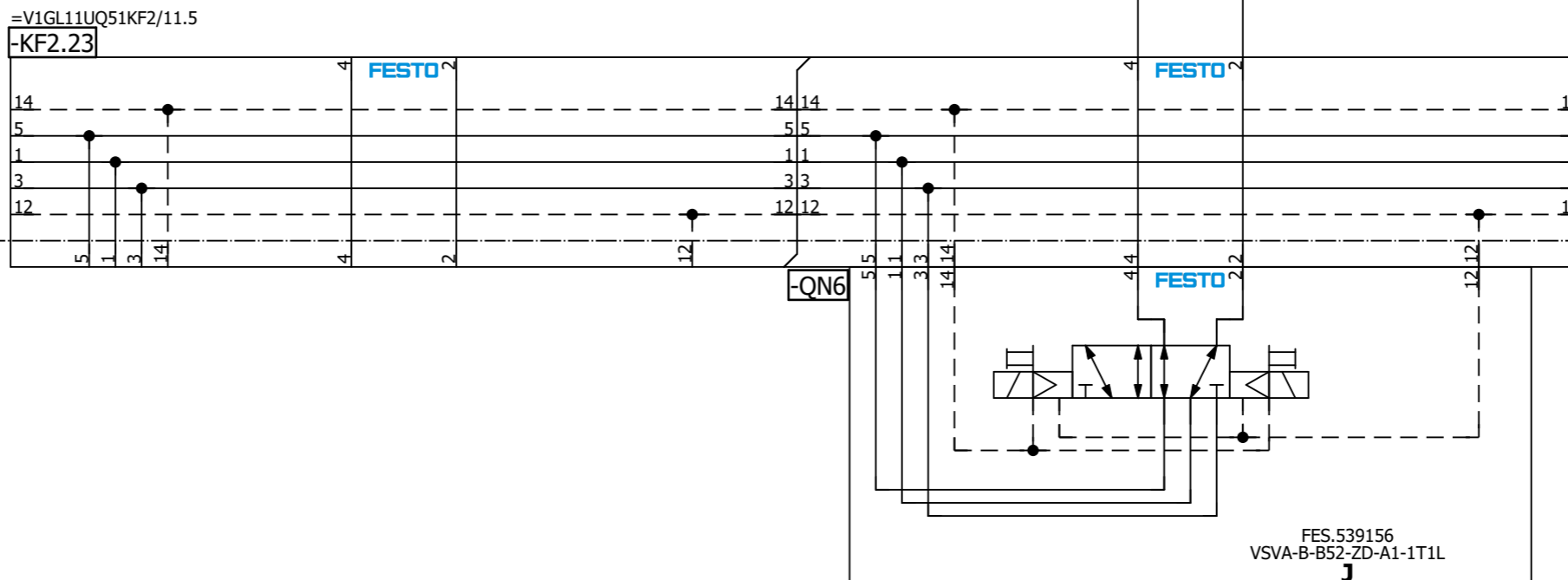

=V1GL11UQ51  
-UQ7-QN6.1  
Pallet Stop Sta #7  
Mid-Stop#4 (RST)

=V1GL11UQ51  
-UQ7-QN6.2  
Pallet Stop Sta #7  
Mid-Stop#4 (SET)

=V1GL11UQ51UQ6/1 =V1GL11UQ51UQ8/1

Date		12/21/2022		Volvo Trucks North America		Valiant TMS		Pallet Stop Station #7 Mid-Stop #4		Drawing name:		= V1GL11UQ51UQ7	
Ed.		MKLEPADLO		P6700 Underbody Mainline - Cell 2V04		Scale 1:1				Document type:		= 2V04&MFS-PNEU	
Appr				Replacement of		Replaced by				Project nr:		22-16151	
Original										Page		1	
Modification		Date		Name						MFS		227	



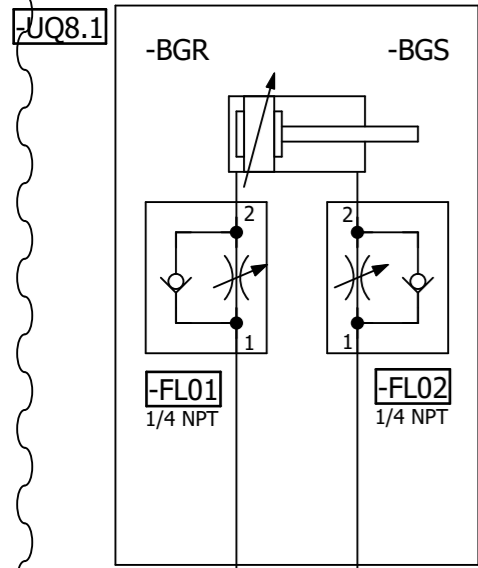

=V1GL11UQ51KF2

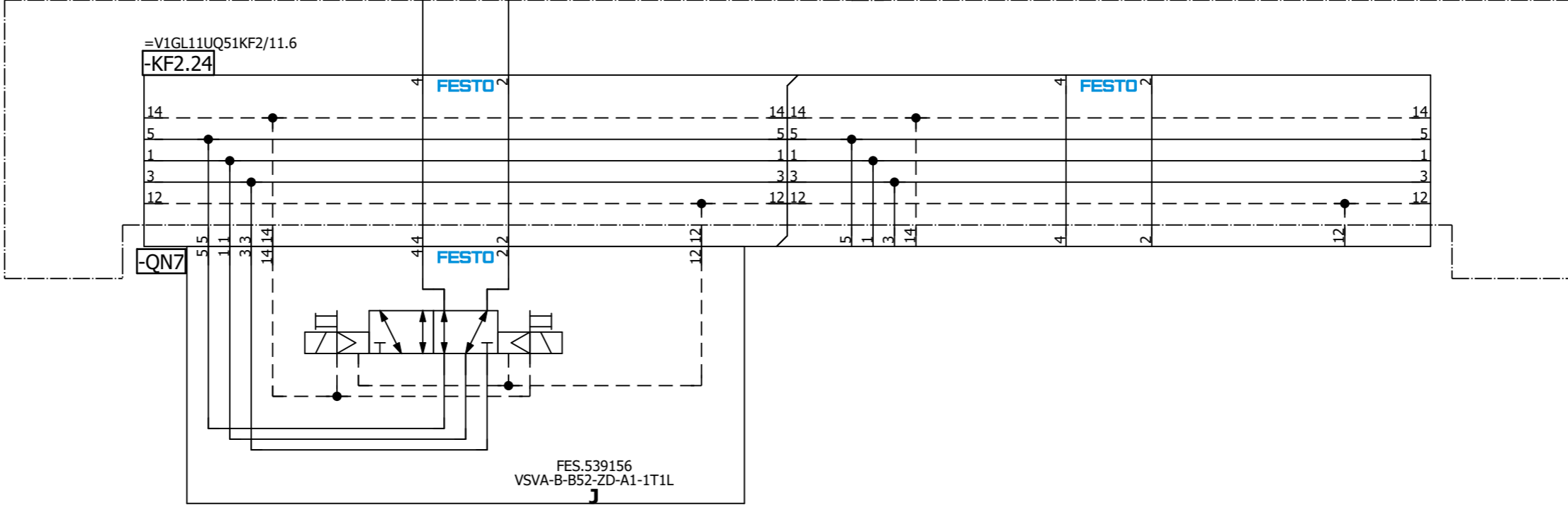

=V1GL11UQ51  
-UQ8-QN7.1  
Pallet Stop Sta #8  
Mid-Stop#5 (RST)

=V1GL11UQ51  
-UQ8-QN7.2  
Pallet Stop Sta #8  
Mid-Stop#5 (SET)

=V1GL11UQ51UQ7/1

=V1GL11UQ51UQ12/1

Volvo Trucks North America			Valiant TMS		Pallet Stop Station #8 Mid-Stop #5		Drawing name: =2V04&MFS-PNEU		= V1GL11UQ51UQ8 + V1GL11UQ51	
P6700 Underbody Mainline - Cell 2V04			Scale 1:1				Document type: MFS		Project nr: 22-16151	
Replacement of			Replaced by						Page 1	
Date: 12/21/2022			Ed.: MKLEPADLO						Page 227	
Appr:										
Original										

=V1GL11UQ51KF2

=V1GL11UQ51KF2/11.6  
-KF2.24

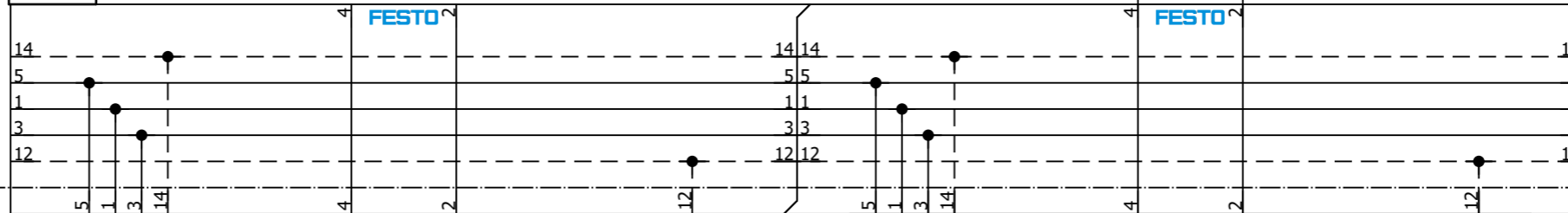

-QN8

FESTO

FESTO

FES.539156  
VSVA-B-B52-ZD-A1-1T1L

=V1GL11UQ51  
-QN8.1  
Spare (RST)

=V1GL11UQ51  
-QN8.2  
Spare (SET)

=V1GL12+KH1/1

=V1GL11UQ51UQ8/1

Modification		Date	Name	Original	Replacement of	Replaced by	Scale 1:1	Project nr: 22-16151	Page 1
		12/21/2022	MKLEPADLO						
Volvo Trucks North America				P6700 Underbody Mainline - Cell 2V04		Valiant TMS		Spare QN8	
Drawing name: =2V04&MFS-PNEU				=V1GL11UQ51UQ12 + V1GL11UQ51		Document type: MFS		Project nr: 22-16151	



A2

=KH0+KH0/1.7 / +V1GL12KH1-P1 →

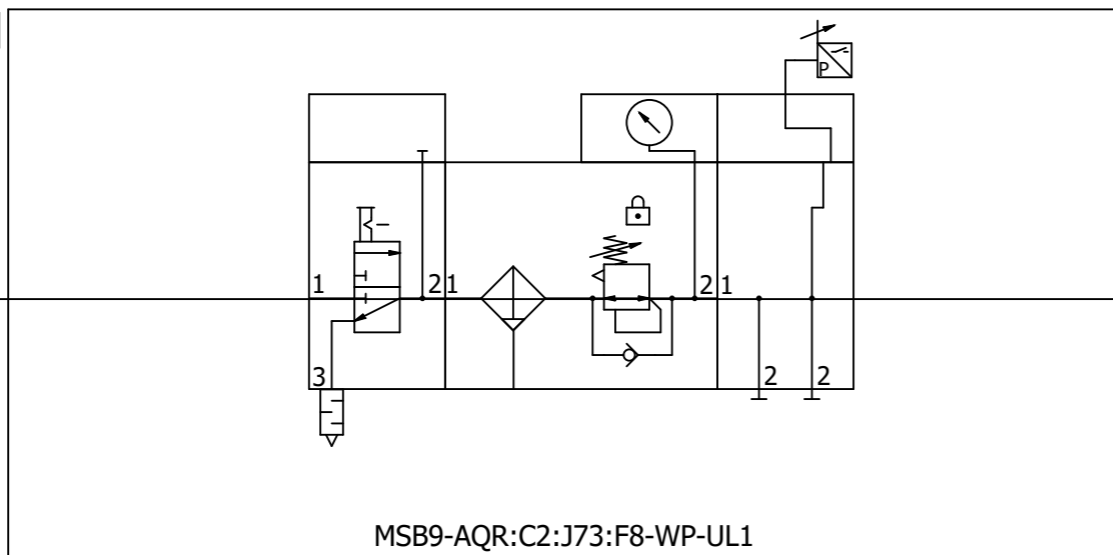

→ +V1GL12UQ51-P1 / =V1GL12UQ51KF2+V1GL12UQ51/11.0

=V1GL11UQ51UQ12+V1GL11UQ51/1

=V1GL12UQ51KF2+V1GL12UQ51/5

			Date	12/21/2022	Volvo Trucks North America		Valiant TMS	Incoming air supply (Fixture)	Drawing name:		= V1GL12
			Ed.	MKLEPADLO	P6700 Underbody Mainline - Cell 2V04					=2V04&MFS-PNEU	
			Appr.						Document type:	Project nr:	Page
Modification	Date	Name	Original		Replacement of	Replaced by	Scale 1:1		MFS	22-16151	1
											227

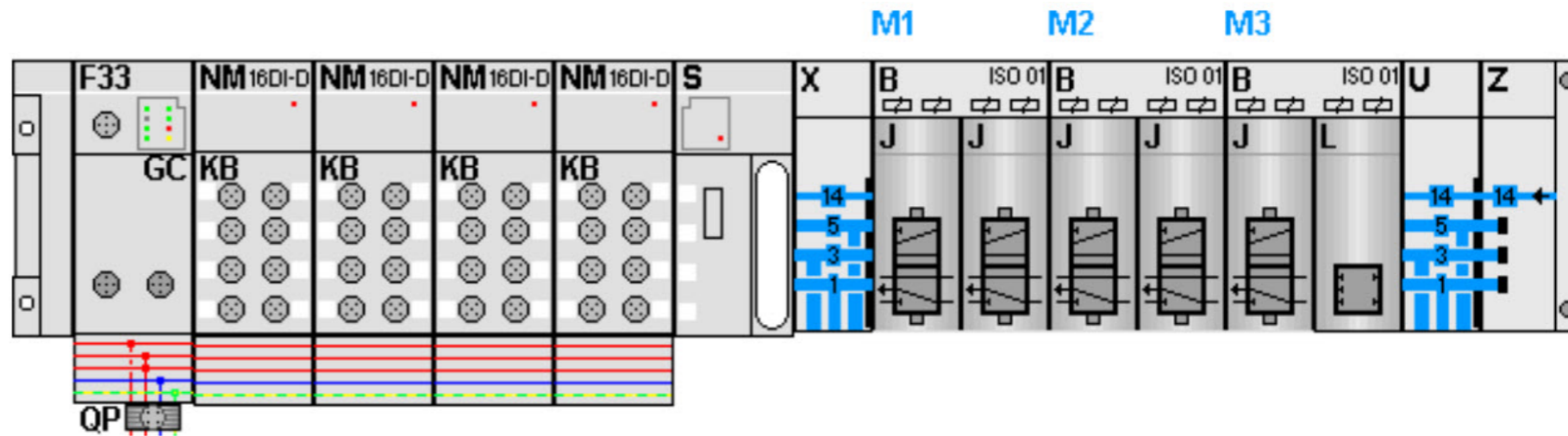

KF2.0

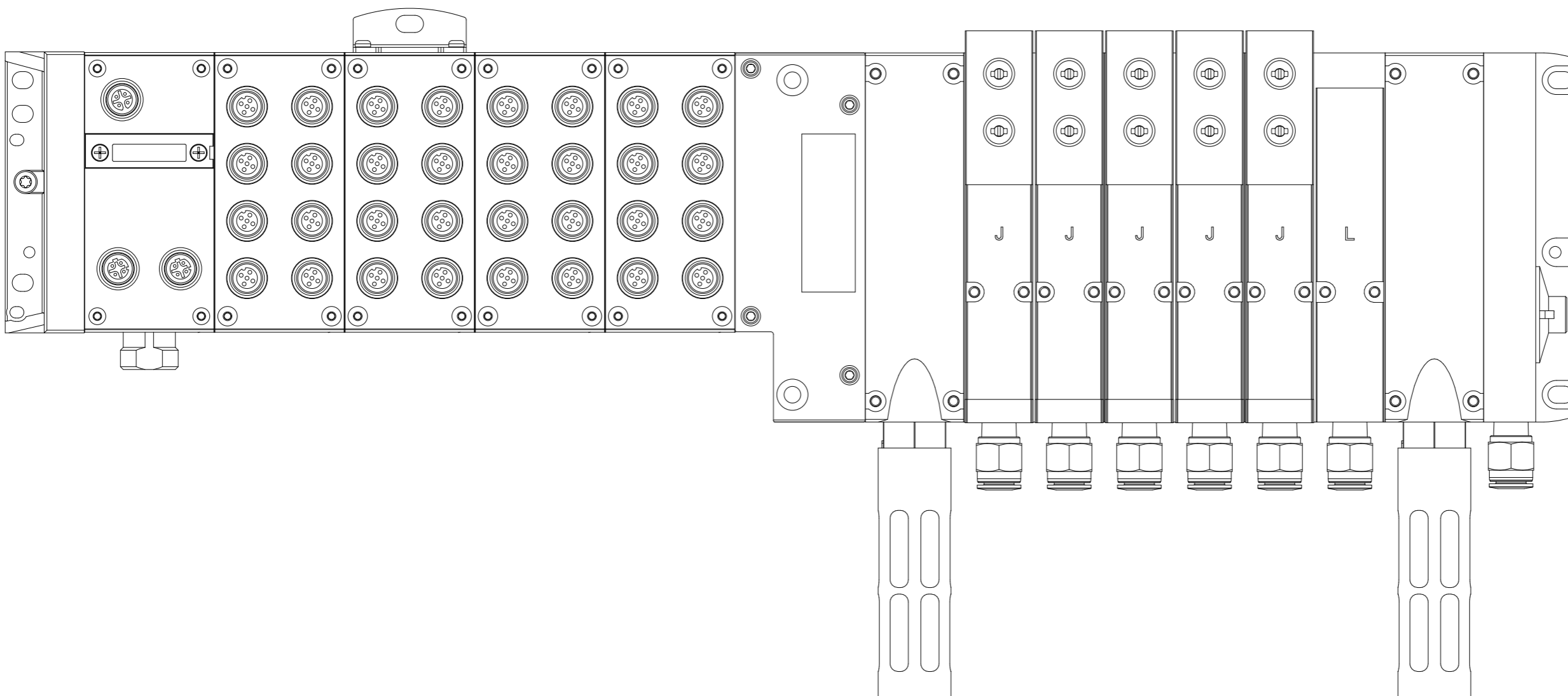

=V1GL12+KH1/1

Date		12/21/2022	Volvo Trucks North America		Valiant TMS	AIR SUPPLY CONFIGURATION	Drawing name:		= V1GL12UQ51KF2
Ed.		MKLEPADLO	P6700 Underbody Mainline - Cell 2V04				=2V04&MFS-PNEU		+ V1GL12UQ51
Appr			Replacement of		Scale 1:1	Document type:	Project nr:	MFS	22-16151
Modification	Date	Name	Original	Replaced by					
									227

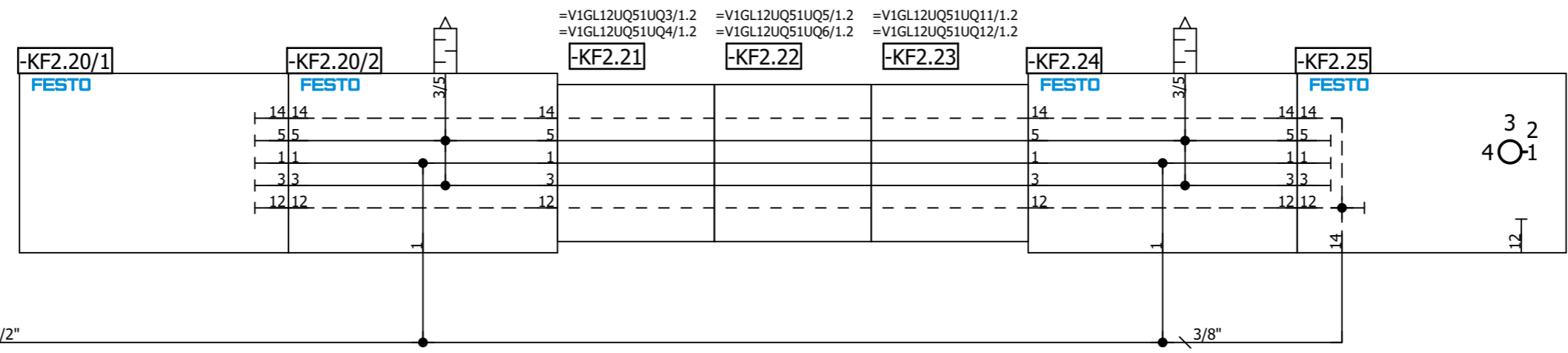
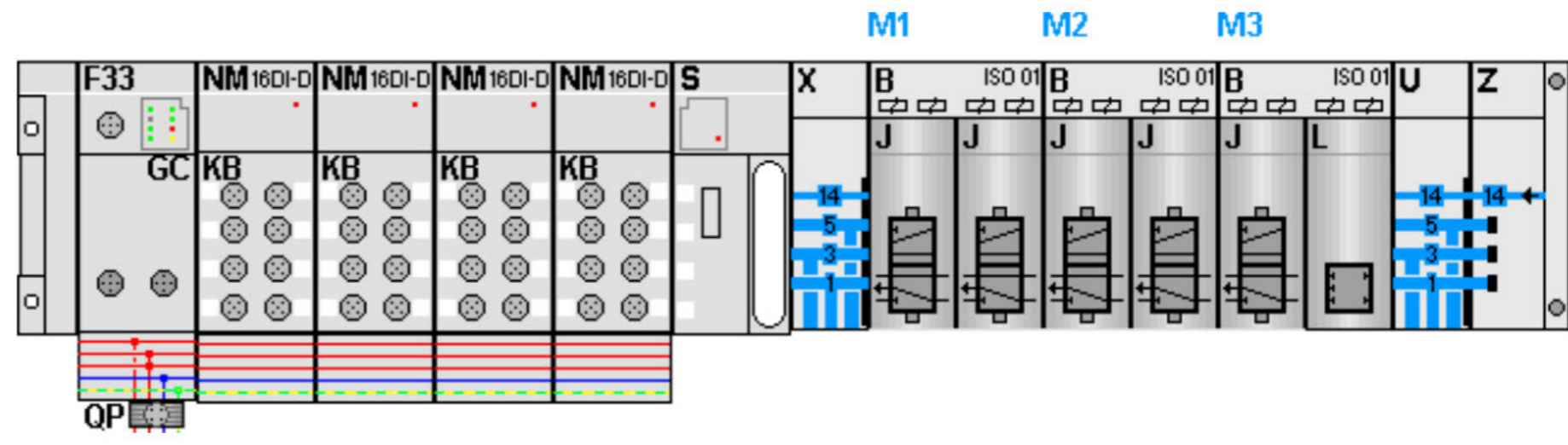

5

Date		12/21/2022	Volvo Trucks North America		Valiant TMS		AIR SUPPLY		Drawing name:		= V1GL12UQ51KF2	
Ed.		MKLEPADLO	P6700 Underbody Mainline - Cell 2V04		Scale 1:1				= 2V04&MFS-PNEU		+ V1GL12UQ51	
Appr			Replacement of		Replaced by				Document type:		Project nr:	
Original									MFS		22-16151	
Modification		Date	Name								Page	
											11	
											227	

=V1GL12UQ51UQ3/1



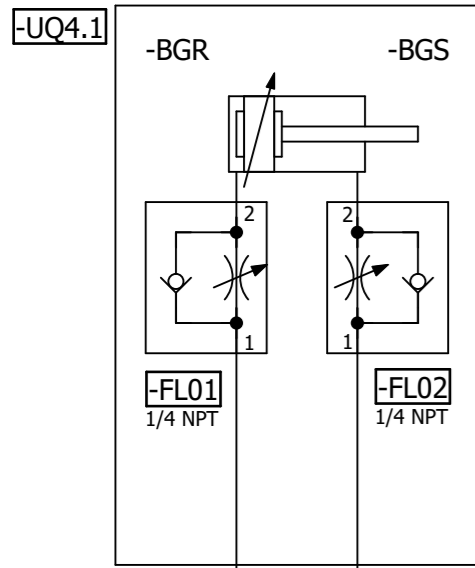

=V1GL12UQ51KF2

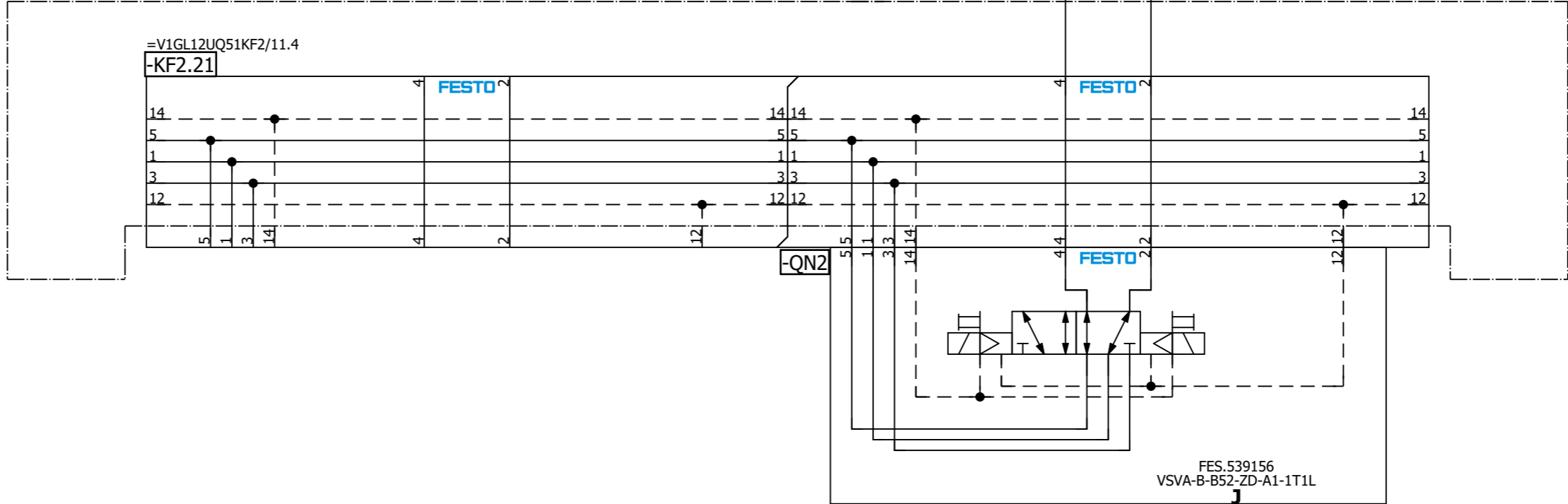

=V1GL12UQ51  
-UQ4-QN2.1  
Pallet Stop Sta #4  
Unload (RST)

=V1GL12UQ51  
-UQ4-QN2.2  
Pallet Stop Sta #4  
Unload (SET)

=V1GL12UQ51UQ5/1

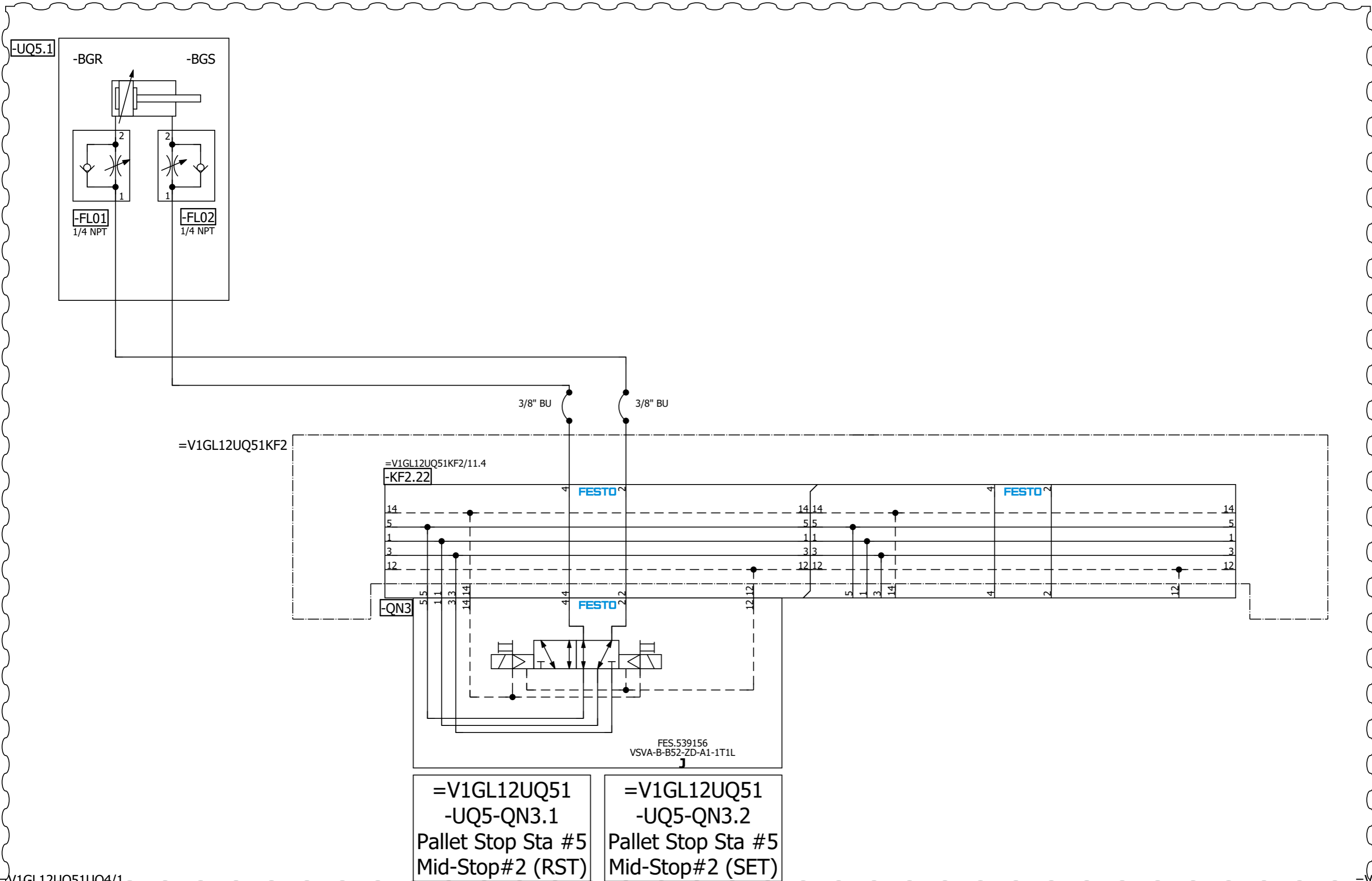

=V1GL12UQ51UQ4/1 =V1GL12UQ51UQ6/1

=V1GL12UQ51  
-UQ5-QN3.1  
Pallet Stop Sta #5  
Mid-Stop#2 (RST)

=V1GL12UQ51  
-UQ5-QN3.2  
Pallet Stop Sta #5  
Mid-Stop#2 (SET)

Modification		Date	Name	Date	12/21/2022	Ed.	MKLEPADLO	Volvo Trucks North America	Valiant TMS	Pallet Stop Station #5 Mid-Stop #2	Drawing name:	= V1GL12UQ51UQ5	Page	1
				Appr				P6700 Underbody Mainline - Cell 2V04	Scale 1:1		Document type:	MFS	Project nr:	22-16151
				Original				Replacement of	Replaced by			+ V1GL12UQ51		227



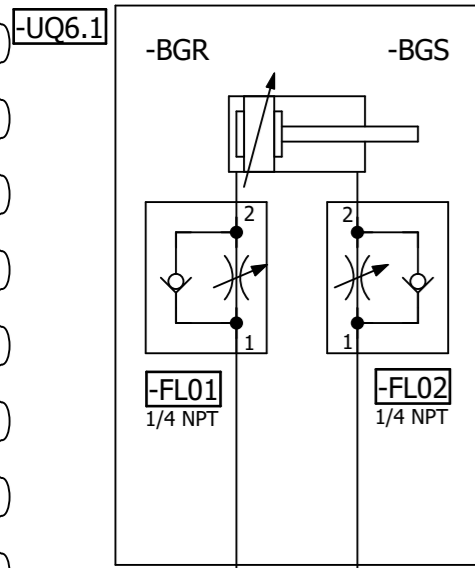

=V1GL12UQ51KF2

=V1GL12UQ51KF2/11.4  
-KF2.22

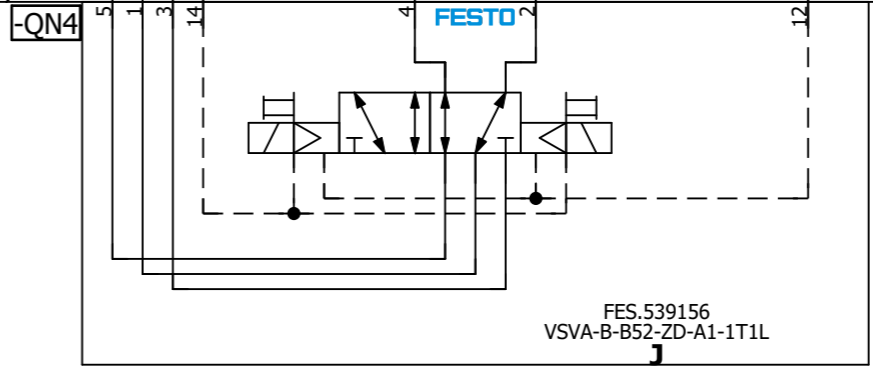
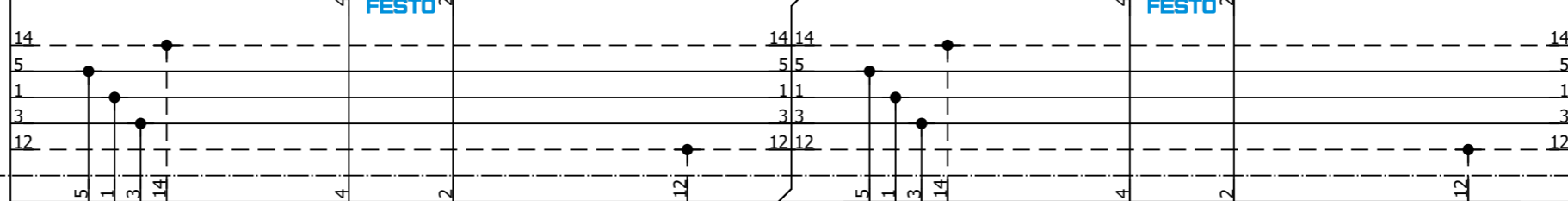

=V1GL12UQ51  
-UQ6-QN4.1  
Pallet Stop Sta #6  
Mid-Stop#3 (RST)

=V1GL12UQ51  
-UQ6-QN4.2  
Pallet Stop Sta #6  
Mid-Stop#3 (SET)

=V1GL12UQ51UQ5/1

=V1GL12UQ51UQ11/1

			Date	12/21/2022	Volvo Trucks North America			Valiant TMS	Pallet Stop Station #6 Mid-Stop #3	Drawing name: =2V04&MFS-PNEU		= V1GL12UQ51UQ6 + V1GL12UQ51	
			Ed.	MKLEPADLO	P6700 Underbody Mainline - Cell 2V04					Document type: MFS		Project nr: 22-16151	
Modification	Date	Name	Original		Replacement of	Replaced by		Scale 1:1					227

=V1GL12UQ51KF2

=V1GL12UQ51KF2/11.5  
-KF2.23

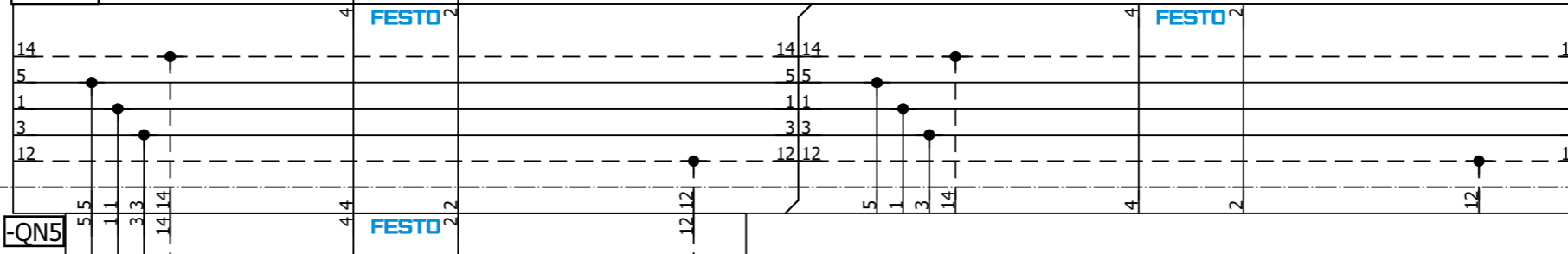

=V1GL12UQ51  
-QN5.1  
Spare (RST)

=V1GL12UQ51  
-QN5.2  
Spare (SET)

=V1GL12UQ51UQ6/1

=V1GL12UQ51UQ12/1

Date: 12/21/2022		Volvo Trucks North America		Valiant TMS		Spare QN5		Drawing name: =2V04&MFS-PNEU		=V1GL12UQ51UQ11	
Ed.: MKLEPADLO		P6700 Underbody Mainline - Cell 2V04		Scale 1:1				Document type: MFS		Project nr: 22-16151	
Appr:		Replacement of		Replaced by				Page: 1		227	
Modification	Date	Name	Original								

=V1GL12UQ51KF2

=V1GL12UQ51KF2/11.5

-KF2.23

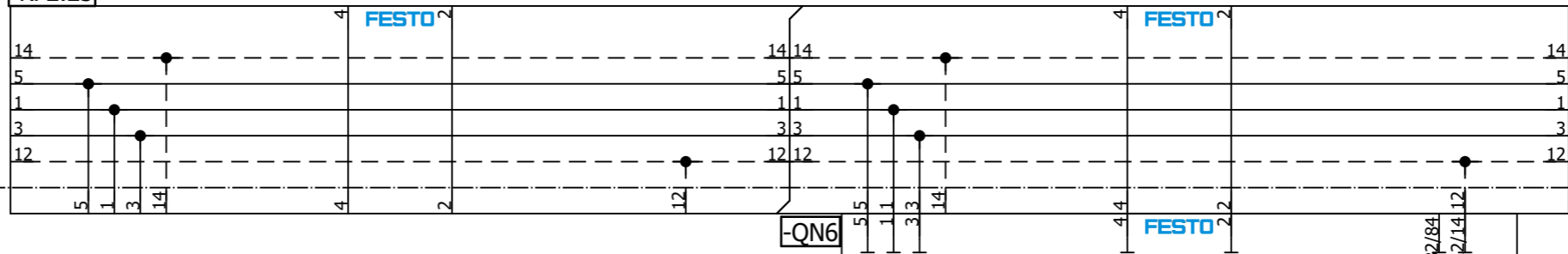

-QN6

FES.539212  
VABB-S4-1-WT

=V1GL12UQ51UQ11/1

=V1GL13+KH1/1

Date		12/21/2022		Volvo Trucks North America		Valiant TMS		Spare		Drawing name:		=V1GL12UQ51UQ12	
Ed.		MKLEPADLO		P6700 Underbody Mainline - Cell 2V04		Scale 1:1				Document type:		=2V04&MFS-PNEU	
Appr				Replacement of		Replaced by				Project nr:		+ V1GL12UQ51	
Modification	Date	Name	Original							22-16151		Page	1
													227

A2

=KH0+KH0/1.7 / +V1GL13KH1-P1 →

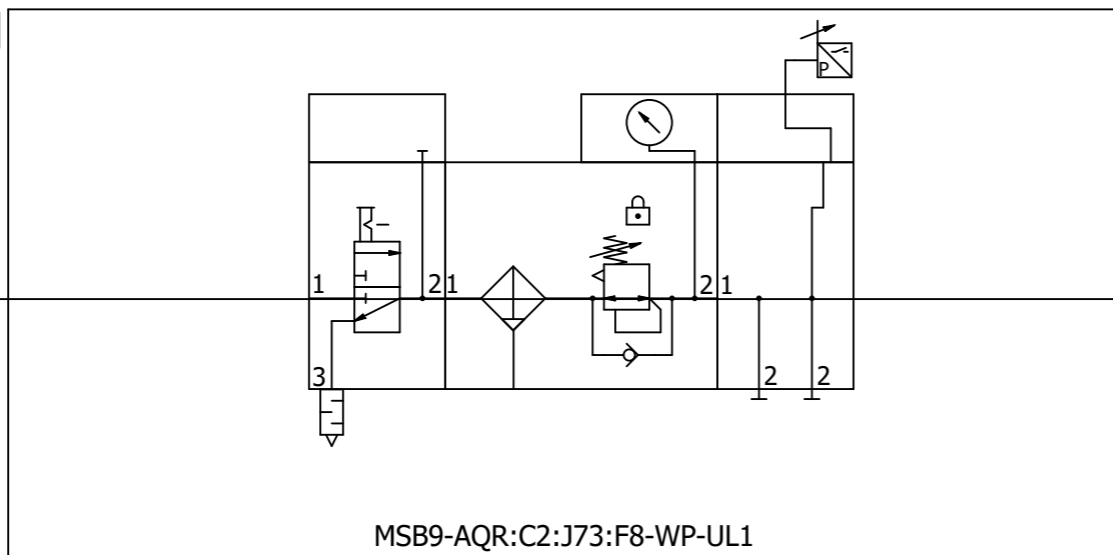

→ +V1GL13UQ51-P1 / =V1GL13UQ51KF1+V1GL13UQ51/11.0

=V1GL12UQ51UQ12+V1GL12UQ51/1

=V1GL13UQ51KF1+V1GL13UQ51/5

		Date	12/21/2022	Volvo Trucks North America			Valiant TMS	Incoming air supply (Fixture)	Drawing name:		= V1GL13			
		Ed.	MKLEPADLO	P6700 Underbody Mainline - Cell 2V04					=2V04&MFS-PNEU	+ KH1				
		Appr		Replacement of			Scale 1:1	Document type:		MFS	Project nr:	22-16151	Page	1
Modification	Date	Name	Original	Replaced by										227

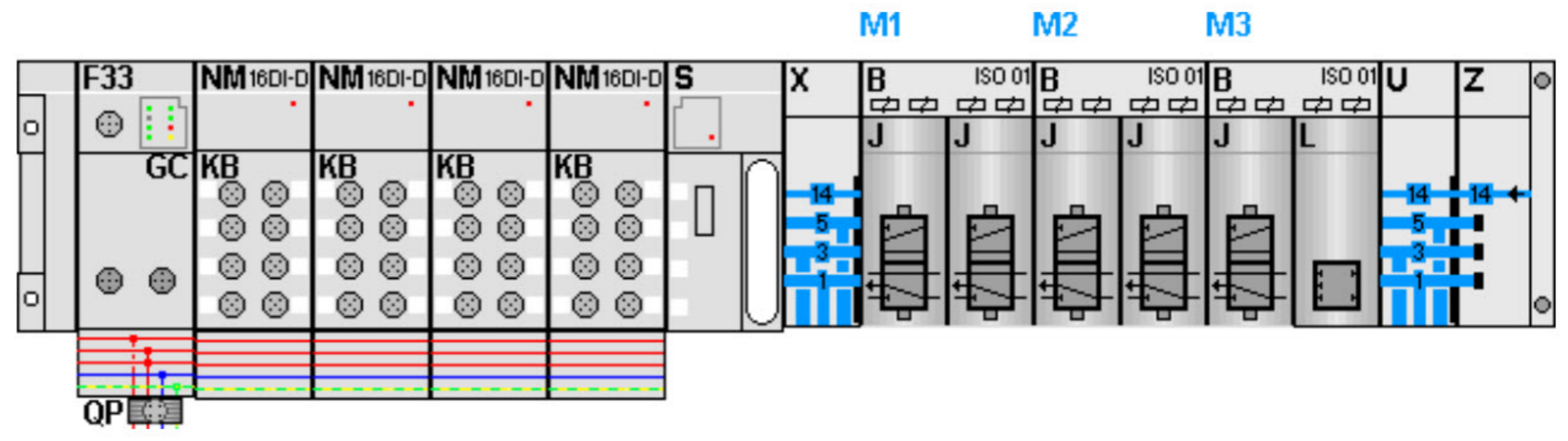

KF1.0

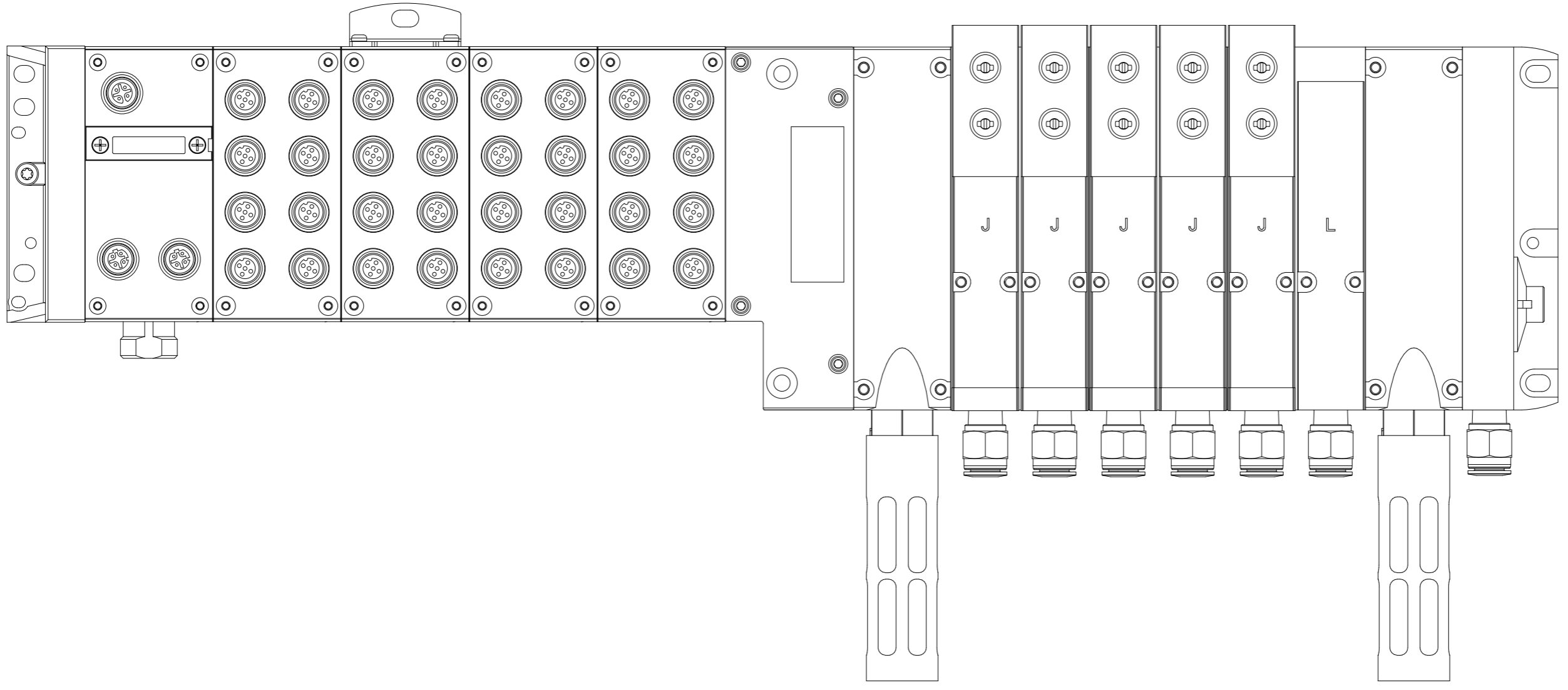

=V1GL13+KH1/1

Date		12/20/2022	Volvo Trucks North America		Valiant TMS	AIR SUPPLY CONFIGURATION	Drawing name:		= V1GL13UQ51KF1			
Ed.		MKLEPADLO	P6700 Underbody Mainline - Cell 2V04				=2V04&MFS-PNEU		+ V1GL13UQ51			
Appr			Replacement of		Scale 1:1	Document type:		MFS	Project nr:	22-16151	Page	5
Modification	Date	Name	Original	Replaced by		MFS		22-16151		227		

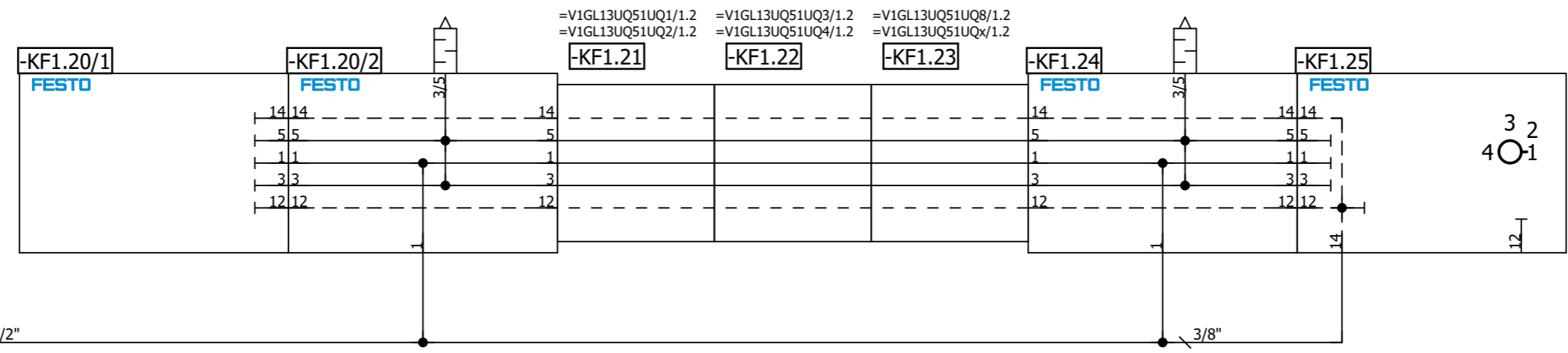
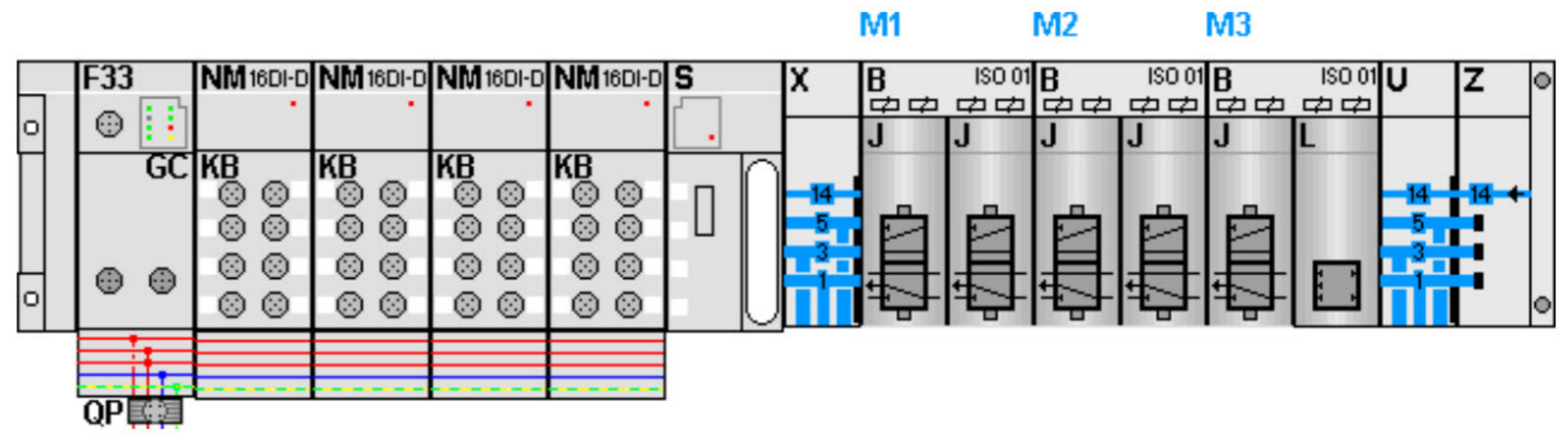

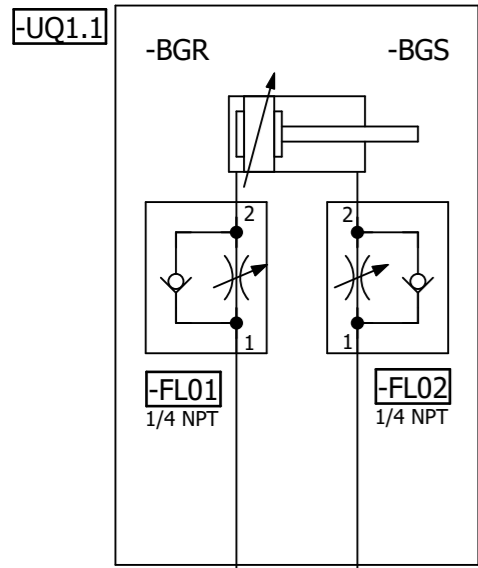

=V1GL13UQ51KF1

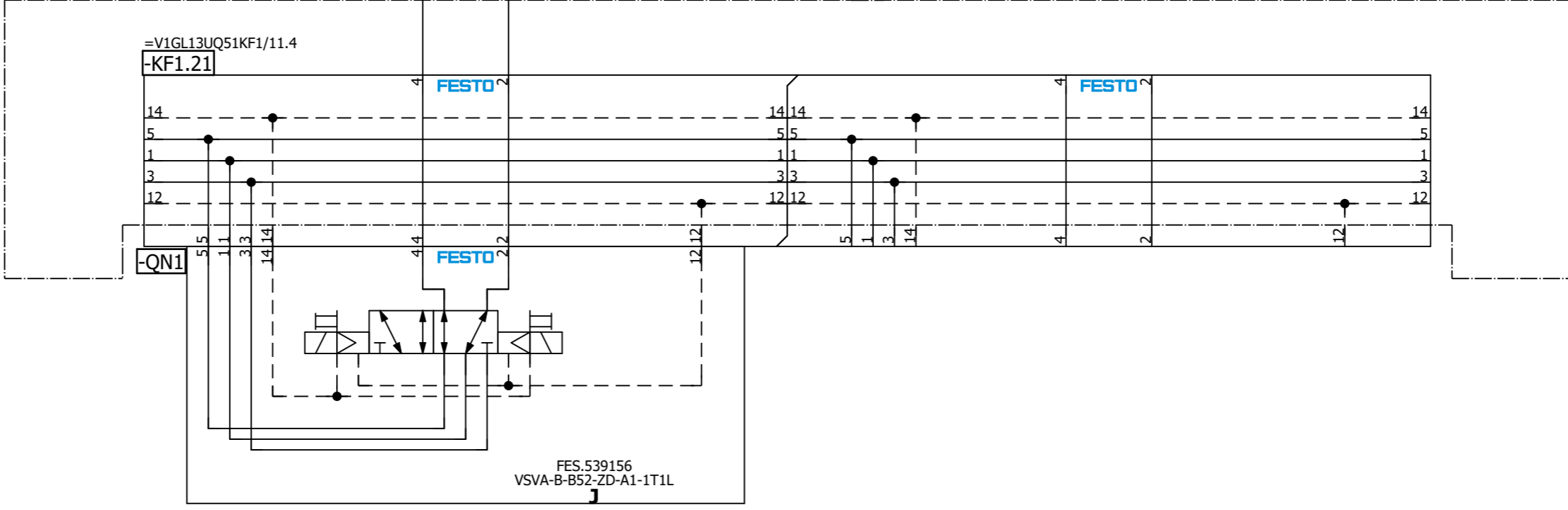

=V1GL13UQ51  
-UQ1-QN1.1  
Pallet Stop Sta #1  
Load (RST)

=V1GL13UQ51  
-UQ1-QN1.2  
Pallet Stop Sta #1  
Load (SET)

=V1GL13UQ51KF1/11

=V1GL13UQ51UQ2/1

Date		12/20/2022	Volvo Trucks North America		Valiant TMS	Pallet Stop Station #1 Load	Drawing name:		= V1GL13UQ51UQ1
Ed.		MKLEPADLO	P6700 Underbody Mainline - Cell 2V04				=2V04&MFS-PNEU		+ V1GL13UQ51
Appr			Replacement of		Scale 1:1		Document type:		MFS
Original			Replaced by				Project nr:		22-16151
Modification	Date	Name	Original				Page		1
									227

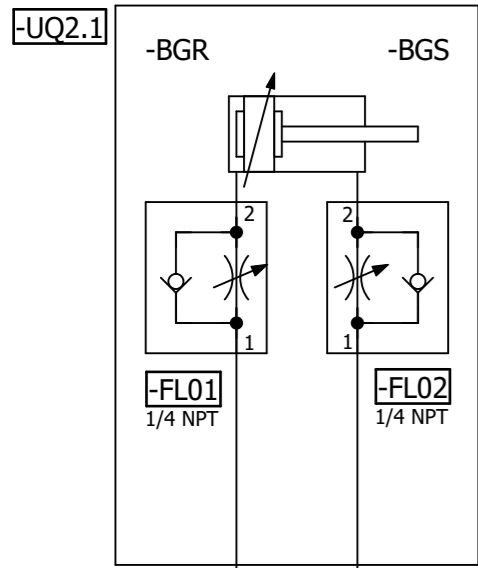

=V1GL13UQ51KF1

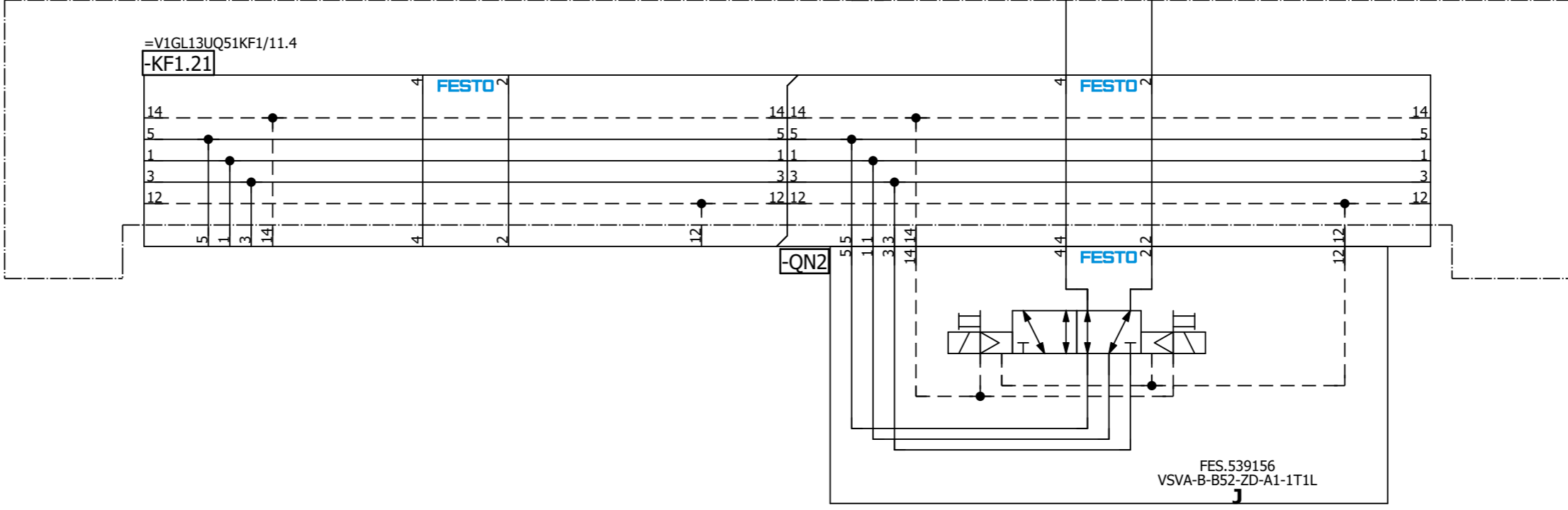

=V1GL13UQ51  
-UQ2-QN2.1  
Pallet Stop Sta #2  
Mid-Stop#1 (RST)

=V1GL13UQ51  
-UQ2-QN2.2  
Pallet Stop Sta #2  
Mid-Stop#1 (SET)

=V1GL13UQ51UQ3/1

=V1GL13UQ51UQ1/1

Modification		Date	Name	Date	12/20/2022	Ed.	MKLEPADLO	Volvo Trucks North America	Valiant TMS	Pallet Stop Station #2 Mid-Stop #1	Drawing name:	= V1GL13UQ51UQ2	Page	1
				Appr.				P6700 Underbody Mainline - Cell 2V04	Scale 1:1		Document type:	+ V1GL13UQ51	Project nr:	22-16151
				Original				Replacement of			MFS			227



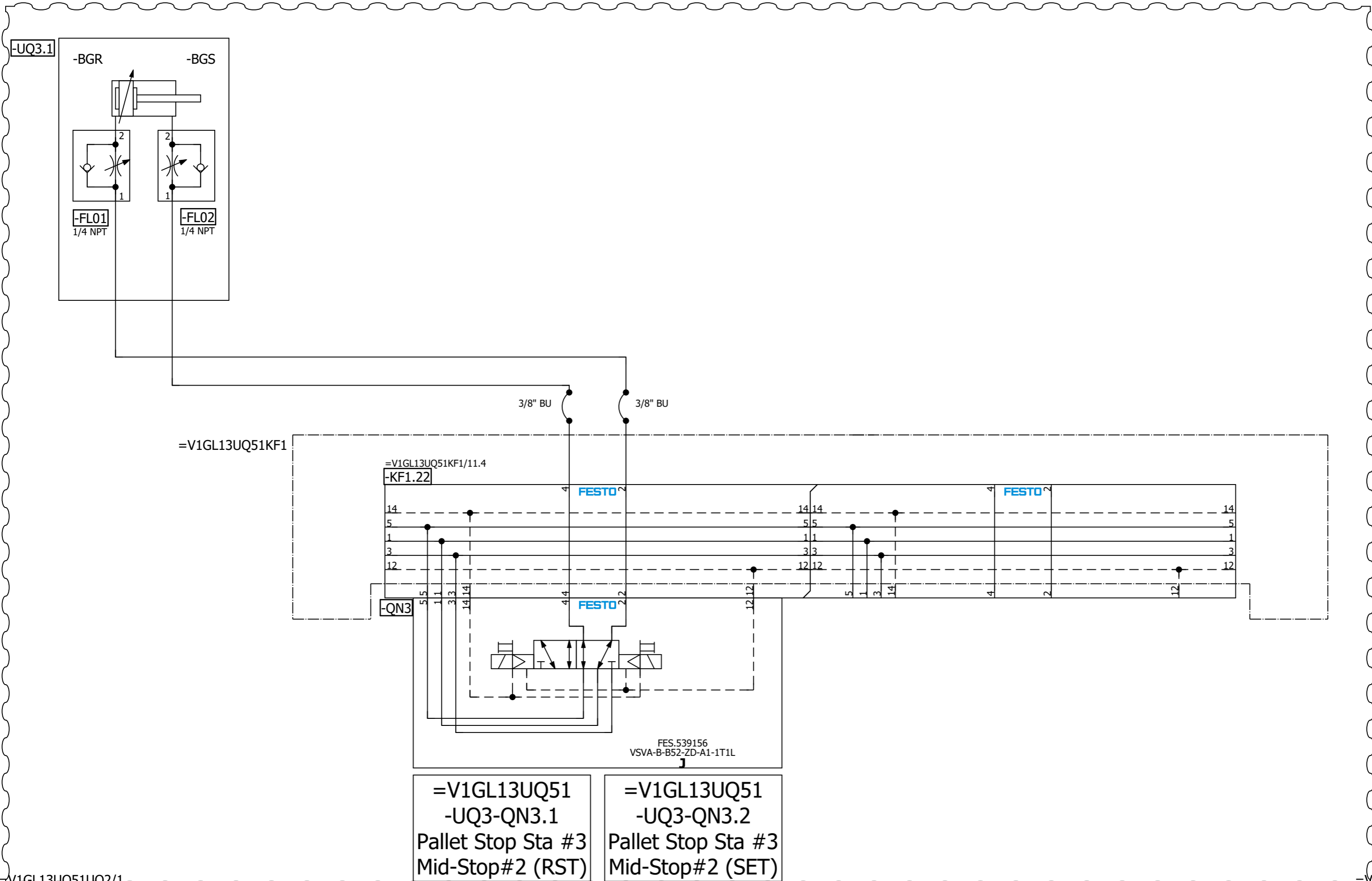

=V1GL13UQ51UQ2/1 =V1GL13UQ51UQ4/1

Modification		Date	Name	Date	12/20/2022	MKLEPADLO	Volvo Trucks North America	Valiant TMS	Pallet Stop Station #3 Mid-Stop #2	Drawing name:	=V1GL13UQ51UQ3	Page	1
				Ed.			P6700 Underbody Mainline - Cell 2V04	Scale 1:1		Document type:	=2V04&MFS-PNEU	Project nr:	22-16151
				Appr			Replacement of			MFS	+ V1GL13UQ51		227
				Original			Replaced by						



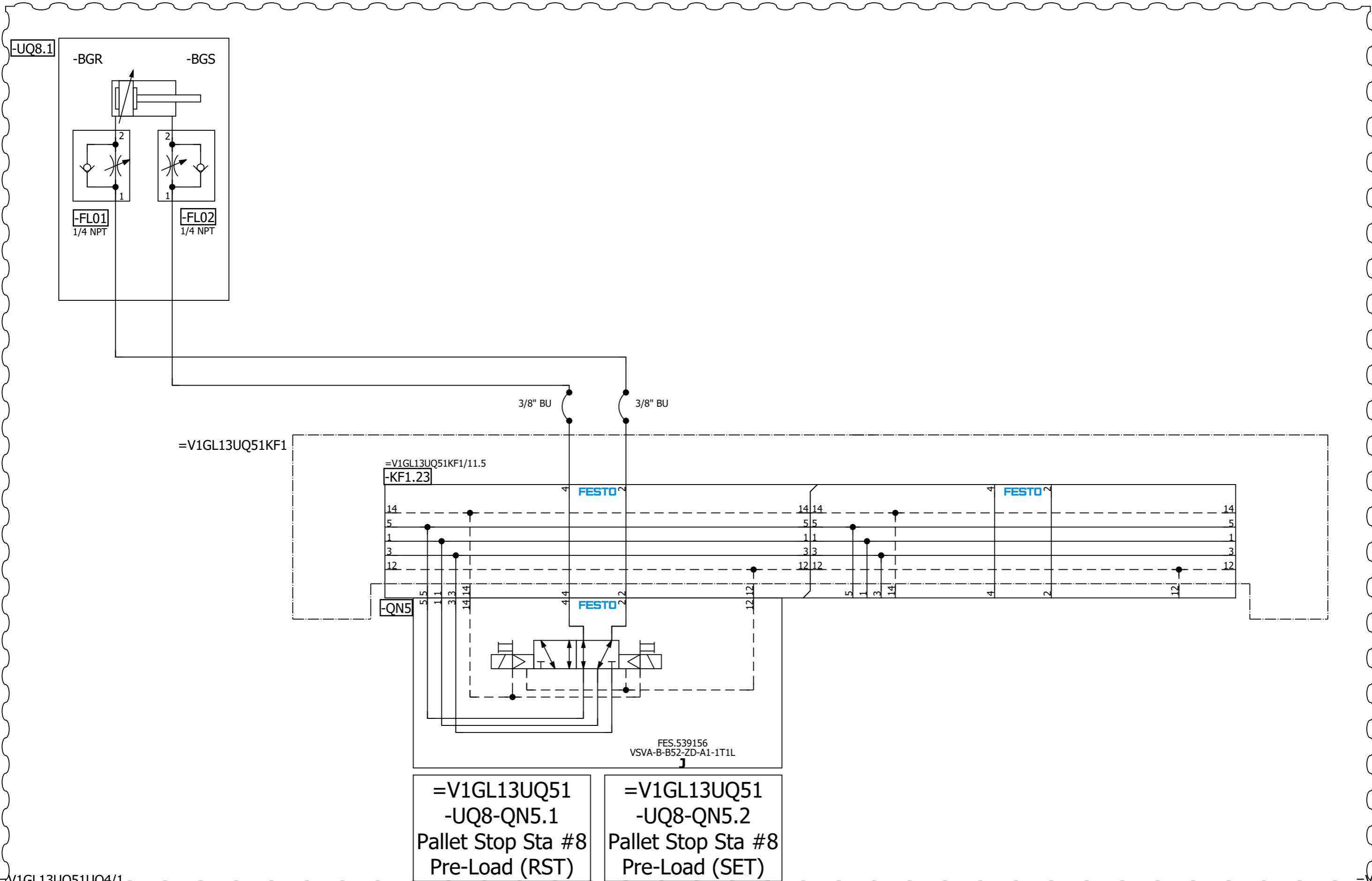

=V1GL13UQ51UQ4/1 =V1GL13UQ51UQx/1

Date		12/20/2022		Volvo Trucks North America		Valiant TMS		Pallet Stop Station #8 Pre-Load		Drawing name:		= V1GL13UQ51UQ8	
Ed.		MKLEPADLO		P6700 Underbody Mainline - Cell 2V04		Scale 1:1				Document type:		= 2V04&MFS-PNEU	
Appr				Replacement of		Replaced by				Project nr:		22-16151	
Original										Page		1	
Modification		Date		Name						MFS		227	



A2

=KH0+KH0/1.7 / +V1UQ51KH1-P1

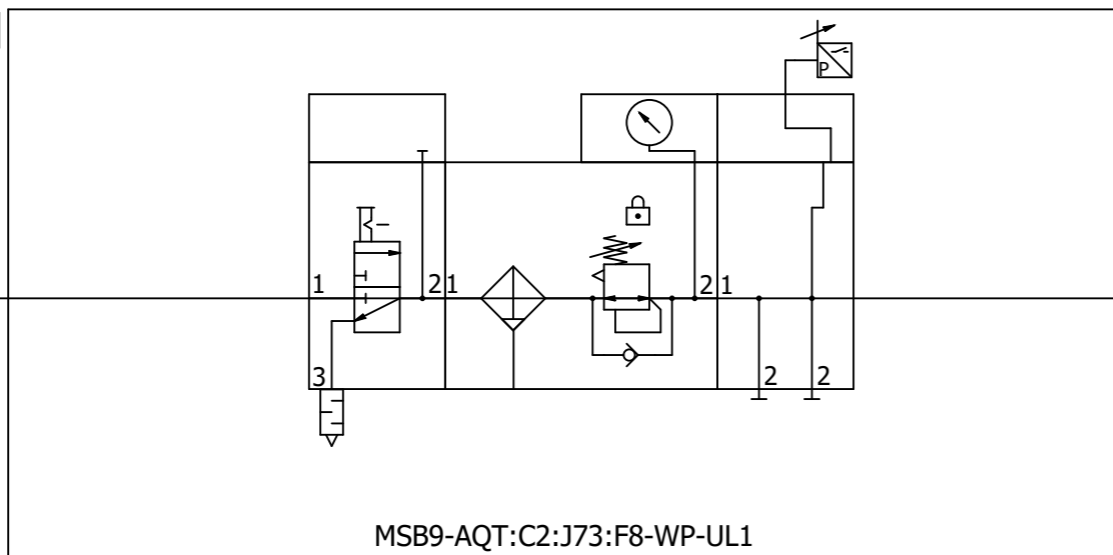

1"

+V1UQ51-P1 / =V1UQ51KF1+V1UQ51/11.0

=V1GL13UQ51UQx+V1GL13UQ51/1

=V1UQ51KF1+V1UQ51/5

			Date	12/21/2022	Volvo Trucks North America		Valiant TMS	Incoming air supply (Fixture)	Drawing name:		= V1UQ51
			Ed.	MKLEPADLO	P6700 Underbody Mainline - Cell 2V04		Scale 1:1		=2V04&MFS-PNEU		+ KH1
Modification	Date	Name	Appr	Original	Replacement of	Replaced by			Document type:	Project nr:	Page
									MFS	22-16151	1
											227

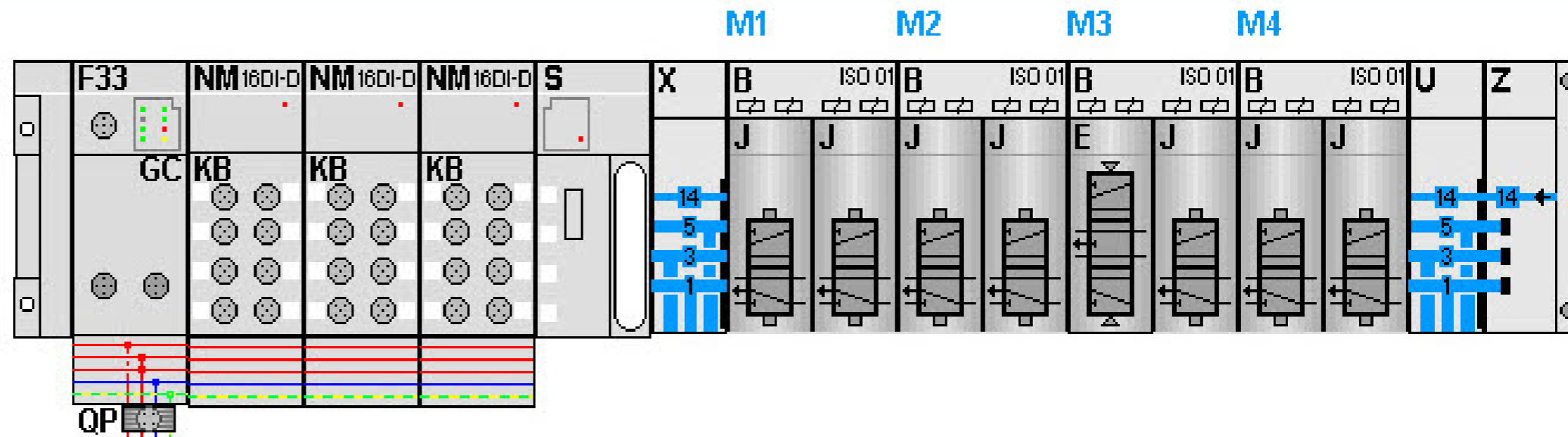

KF1.0

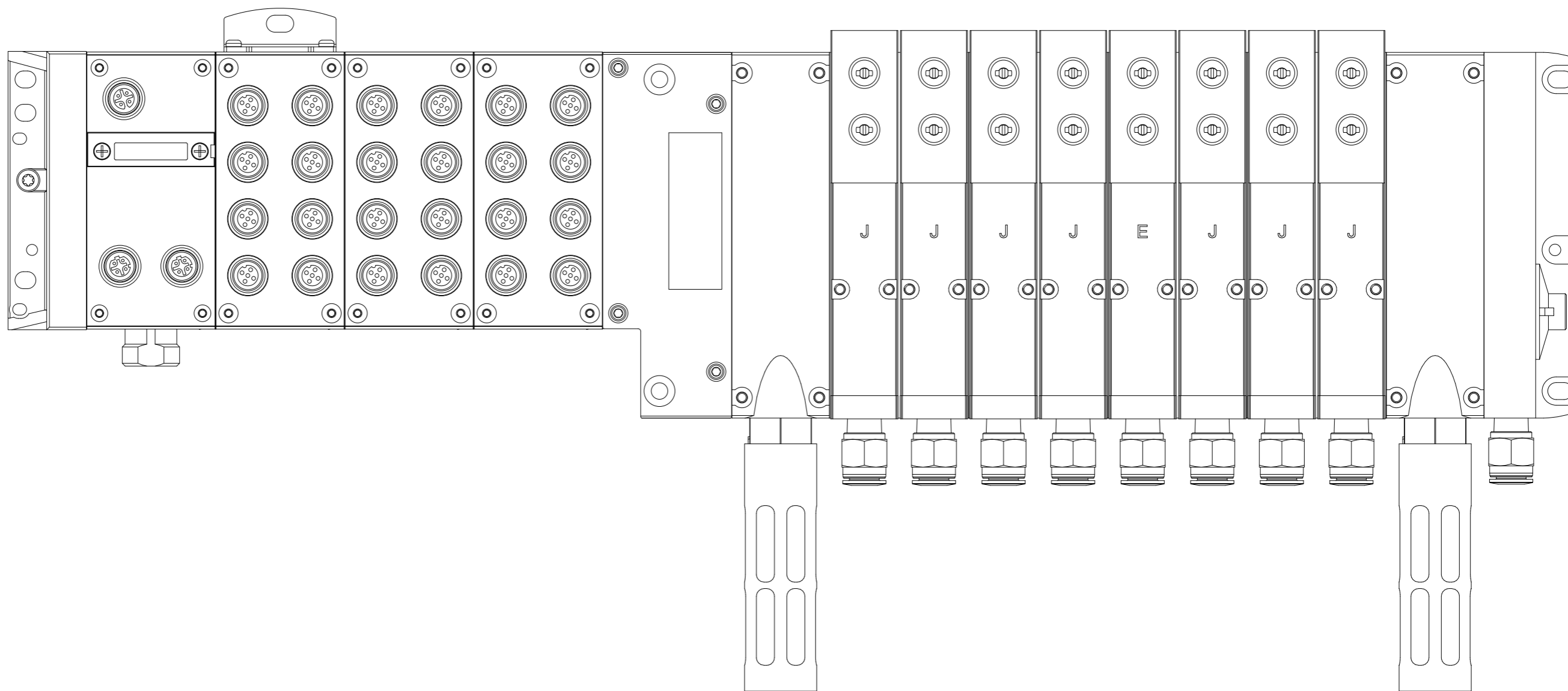

=V1UQ51+KH1/1

Date		12/21/2022	Volvo Trucks North America		Valiant TMS	AIR SUPPLY CONFIGURATION	Drawing name:		= V1UQ51KF1
Ed.		MKLEPADLO	P6700 Underbody Mainline - Cell 2V04				=2V04&MFS-PNEU		+ V1UQ51
Appr.			Replacement of		Scale 1:1	Document type:	Project nr:	22-16151	Page
Modification	Date	Name	Original	Replaced by					MFS
								227	



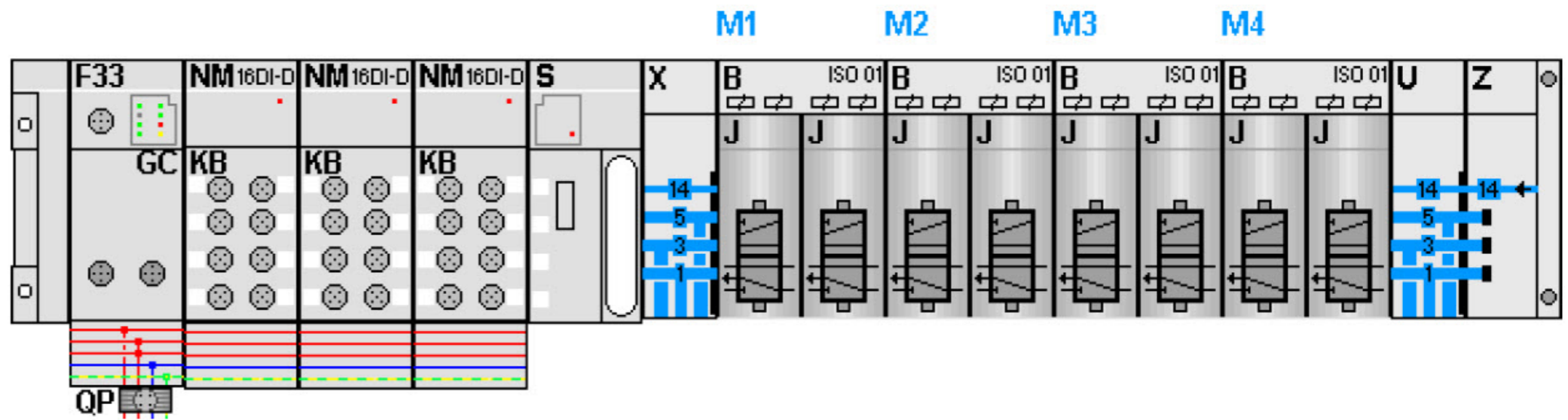

KF2.0

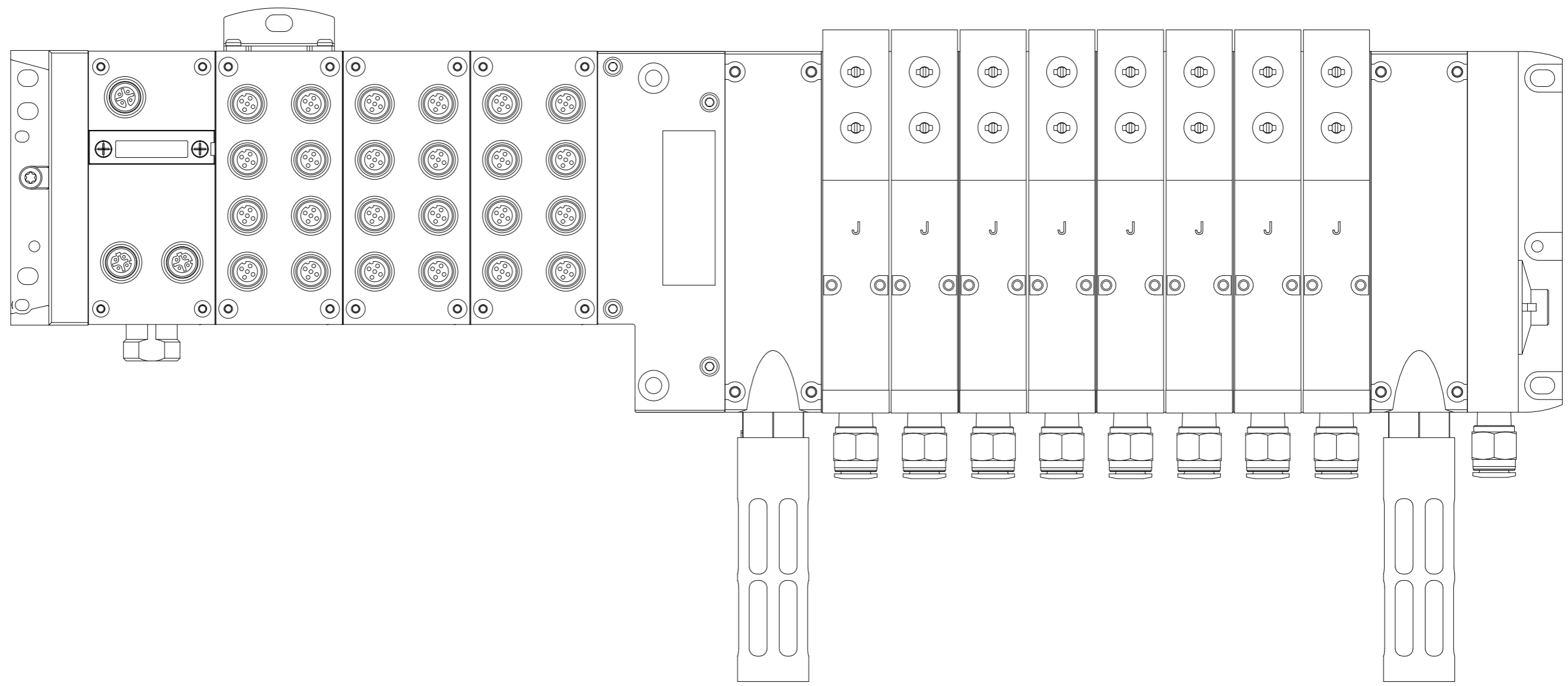

=V1UQ51KF1/11

Date		12/21/2022	Volvo Trucks North America		Valiant TMS	AIR SUPPLY CONFIGURATION	Drawing name:		= V1UQ51KF2
Ed.		MKLEPADLO	P6700 Underbody Mainline - Cell 2V04				=2V04&MFS-PNEU		+ V1UQ51
Appr			Replacement of		Scale 1:1	Document type:	Project nr:	MFS	22-16151
Modification	Date	Name	Original	Replaced by					
									227



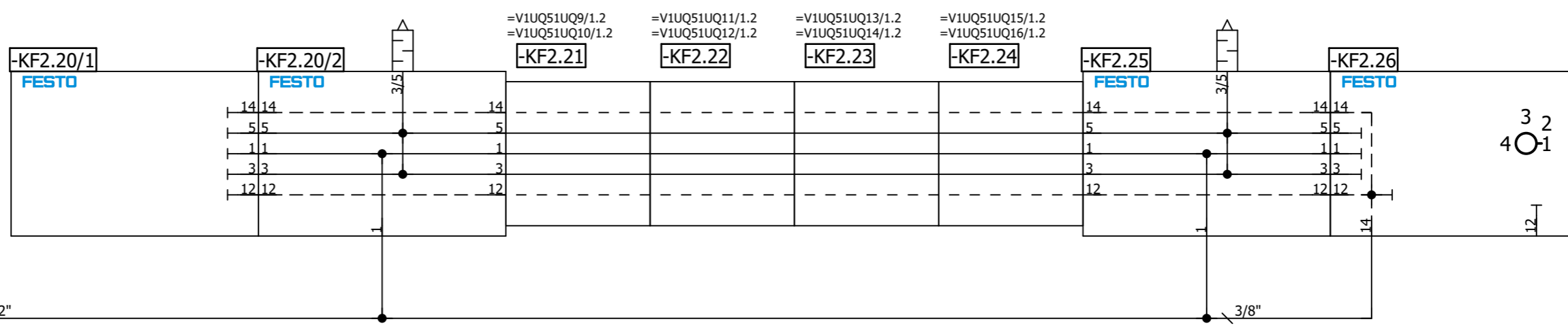
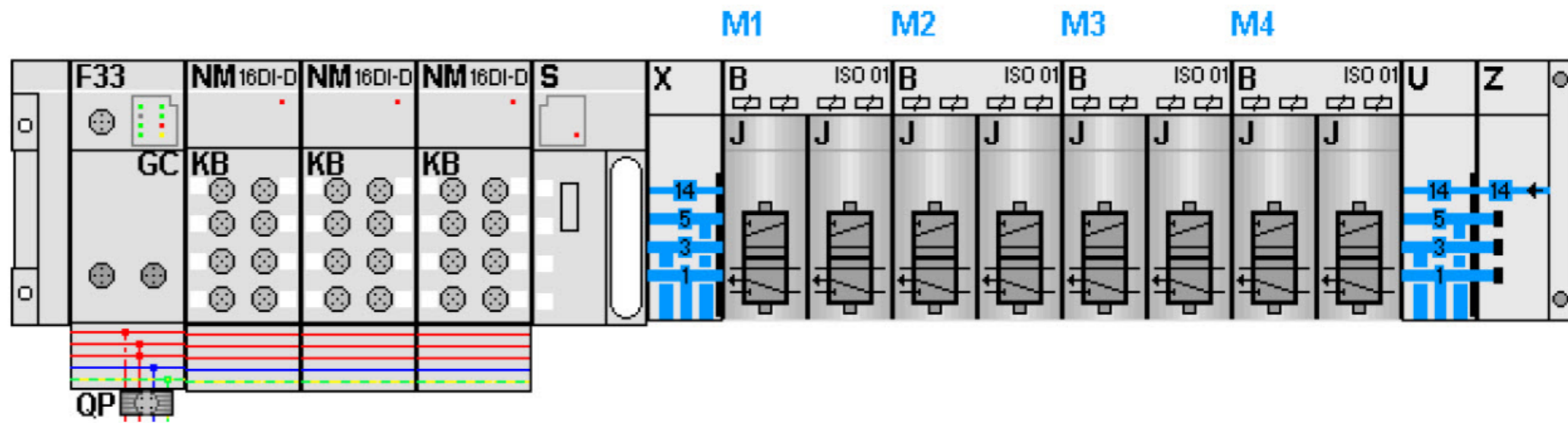

=V1UQ51KF1/11.1 / P2 → 1/2"

3/8"

Date	12/21/2022	Volvo Trucks North America	Valiant TMS	AIR SUPPLY	Drawing name:	= V1UQ51KF2		
Ed.	MKLEPADLO	P6700 Underbody Mainline - Cell 2V04	Scale 1:1		= 2V04&MFS-PNEU	+ V1UQ51		
Appr.					Document type:	MFS	Project nr:	22-16151
Modification	Date	Name	Original	Replacement of	Replaced by			227



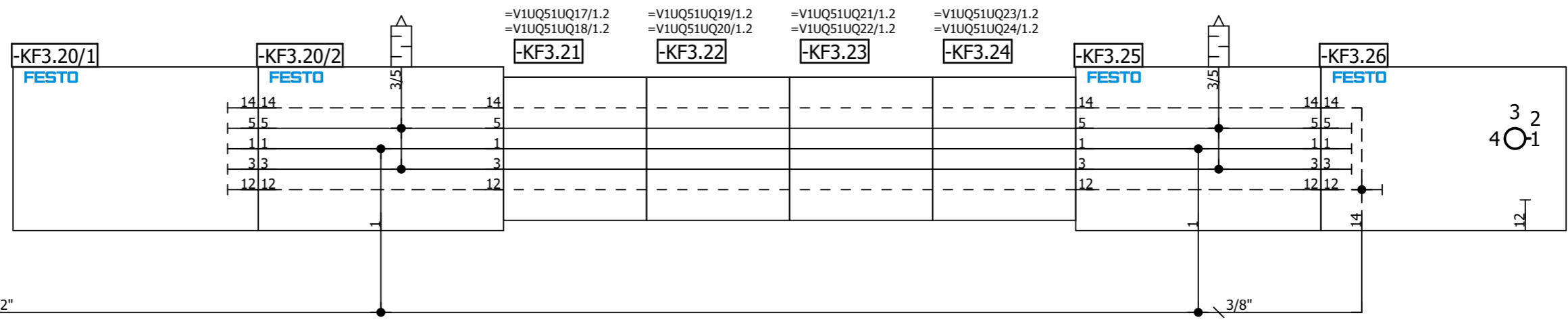
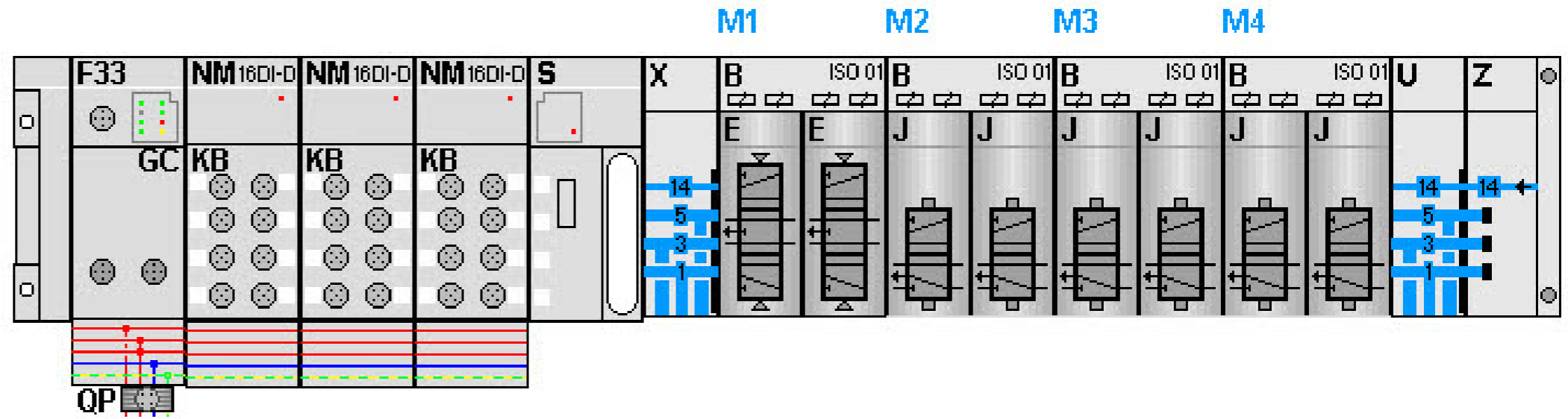

=V1UQ51KF1/11.1 / P3

5

=V1UQ51UQ1/1

Date	12/21/2022	Volvo Trucks North America	Valiant TMS	AIR SUPPLY	Drawing name:	= V1UQ51KF3	
Ed.	MKLEPADLO	P6700 Underbody Mainline - Cell 2V04	Scale 1:1		= 2V04&MFS-PNEU	+ V1UQ51	
Appr.					Document type:	MFS	Project nr:
Modification	Date	Name	Original	Replacement of	Replaced by	Page	11
							227

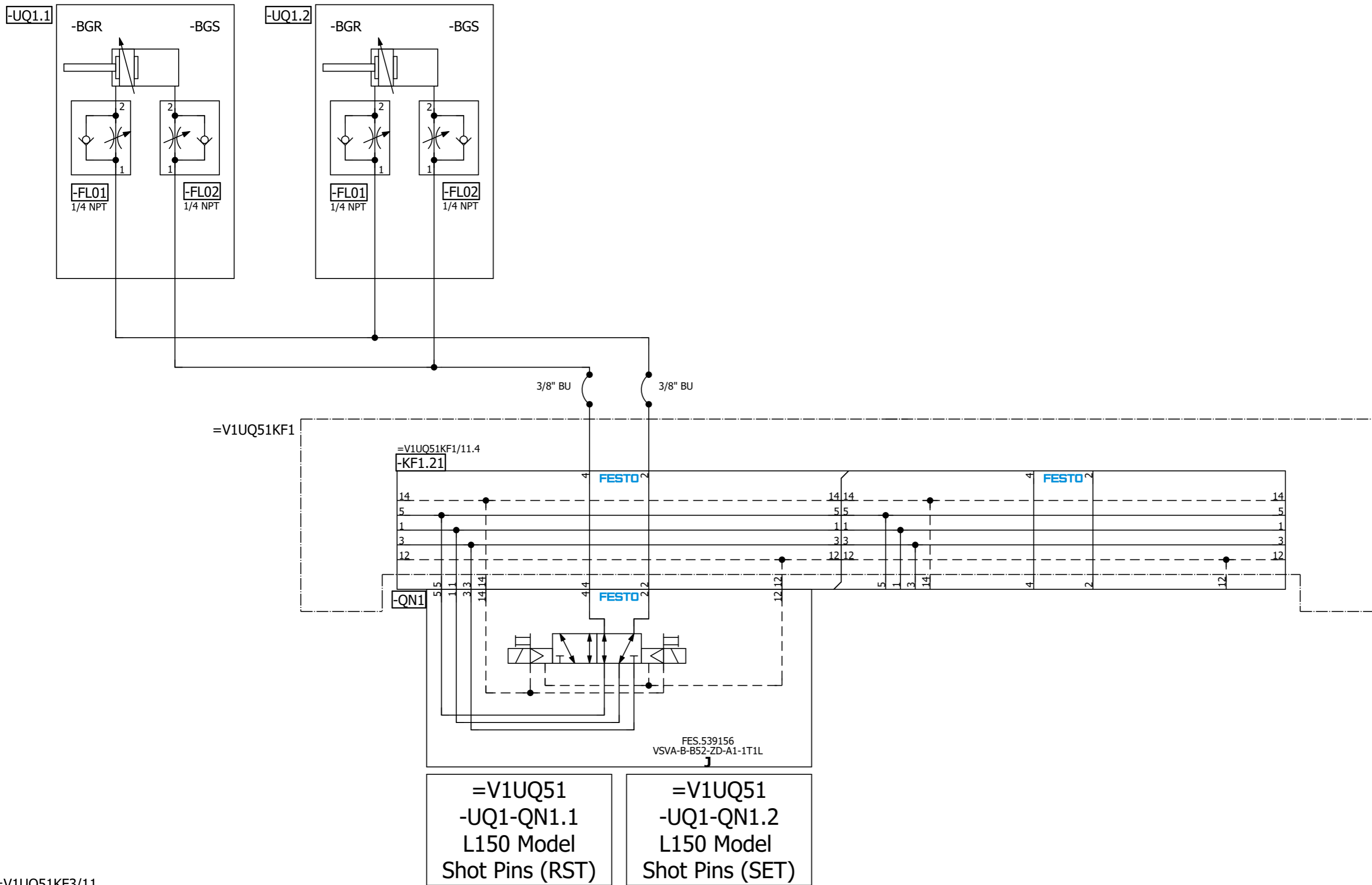

=V1UQ51KF3/11

=V1UQ51UQ2/1

Date		12/21/2022		Volvo Trucks North America		Valiant TMS		L150 Model Shot Pins		Drawing name:		= V1UQ51UQ1	
Ed.		MKLEPADLO		P6700 Underbody Mainline - Cell 2V04		Scale 1:1				Document type:		= 2V04&MFS-PNEU	
Appr.				Replacement of		Replaced by				Project nr:		+ V1UQ51	
Modification		Date		Name		Original				MFS		Page 1	
										22-16151		227	

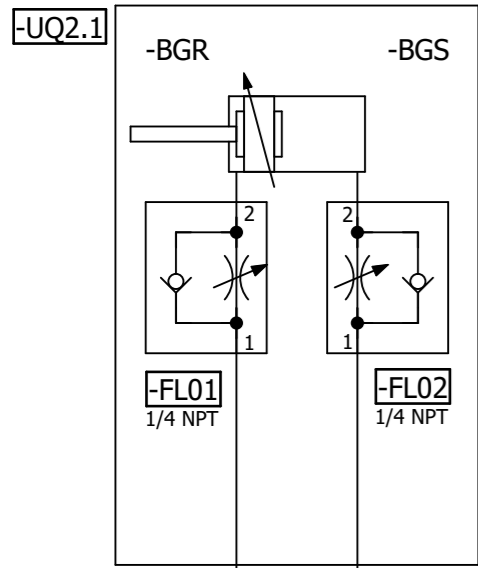

=V1UQ51KF1

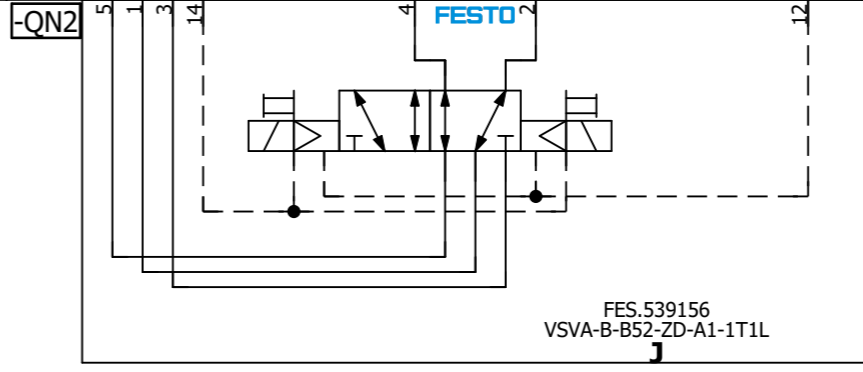
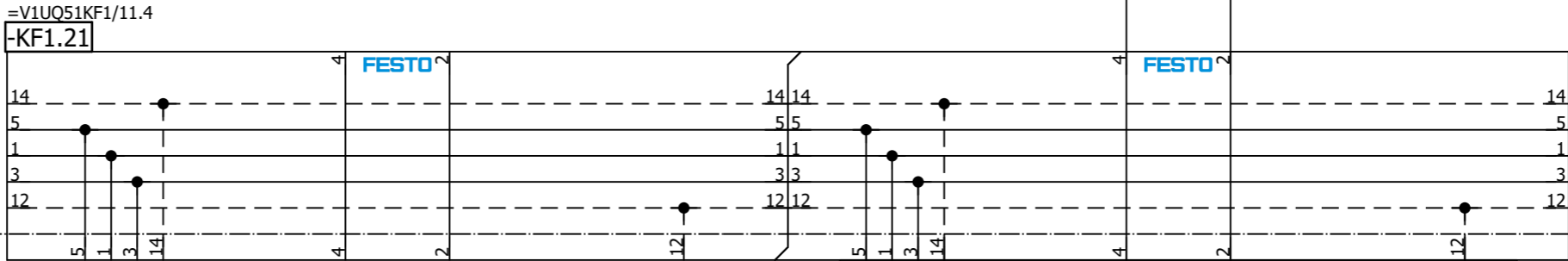

=V1UQ51  
-UQ2-QN2.1  
Common  
Shot Pin (RST)

=V1UQ51  
-UQ2-QN2.2  
Common  
Shot Pin (SET)

=V1UQ51UQ1/1

=V1UQ51UQ3/1

Date		12/21/2022	Volvo Trucks North America		Valiant TMS	Common Shot Pin 1	Drawing name:		= V1UQ51UQ2
Ed.		MKLEPADLO	P6700 Underbody Mainline - Cell 2V04				=2V04&MFS-PNEU		+ V1UQ51
Appr			Replacement of		Scale 1:1		Document type:		Project nr:
Original			Replaced by				MFS		22-16151
Modification		Date	Name	Original					227



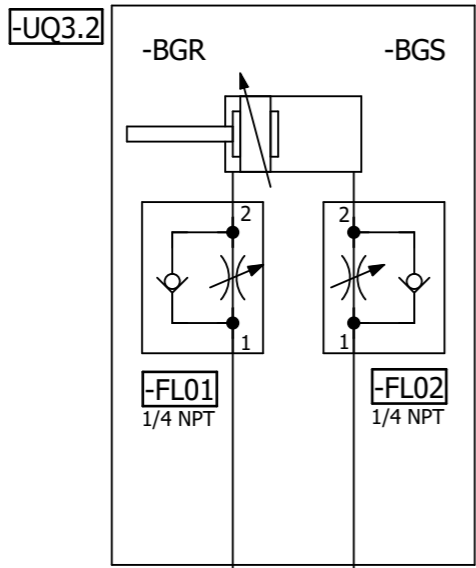
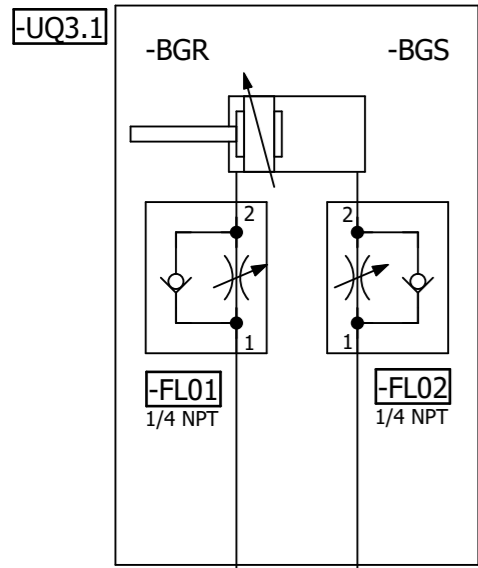

=V1UQ51KF1

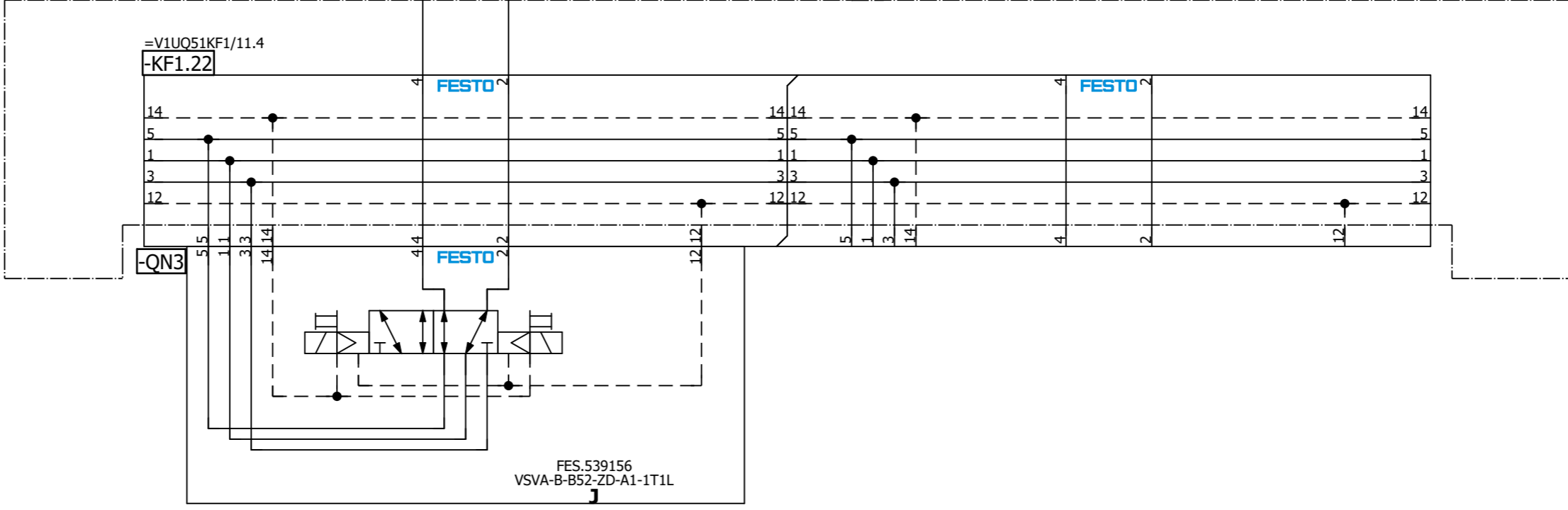

=V1UQ51  
-UQ3-QN3.1  
L150/230 Model  
Shot Pins (RST)

=V1UQ51  
-UQ3-QN3.2  
L150/230 Model  
Shot Pins (SET)

=V1UQ51UQ2/1

=V1UQ51UQ4/1

Date		12/21/2022		Volvo Trucks North America		Valiant TMS		L150_230 Model Shot Pins		Drawing name:		= V1UQ51UQ3	
Ed.		MKLEPADLO		P6700 Underbody Mainline - Cell 2V04		Scale 1:1				Document type:		= 2V04&MFS-PNEU	
Appr				Replacement of		Replaced by				Project nr:		+ V1UQ51	
Original										MFS		Page 1	
Modification		Date		Name						22-16151		227	

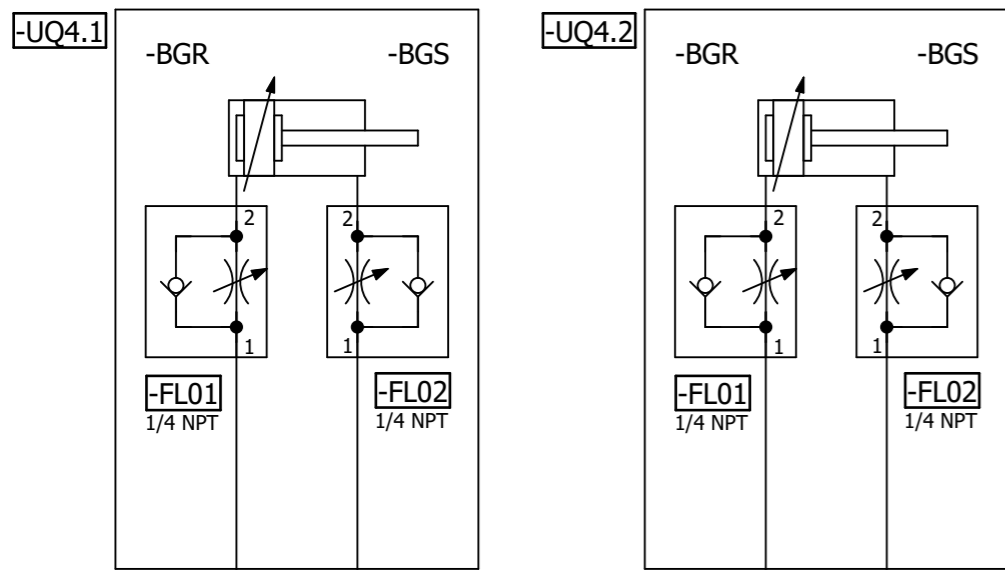

=V1UQ51KF1

=V1UQ51KF1/11.4  
-KF1.22

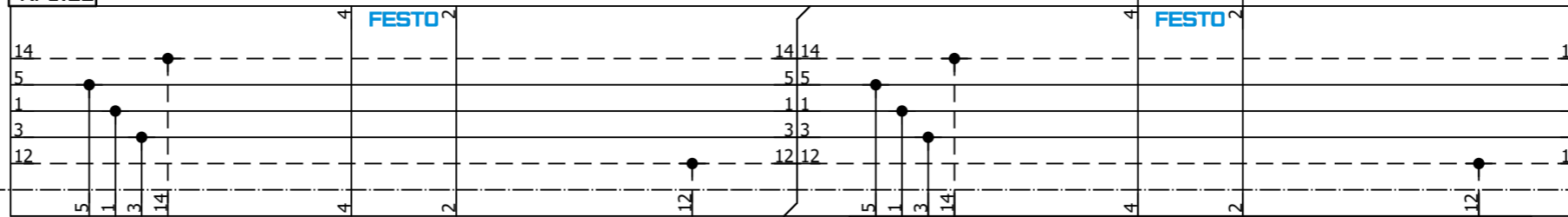

-QN4

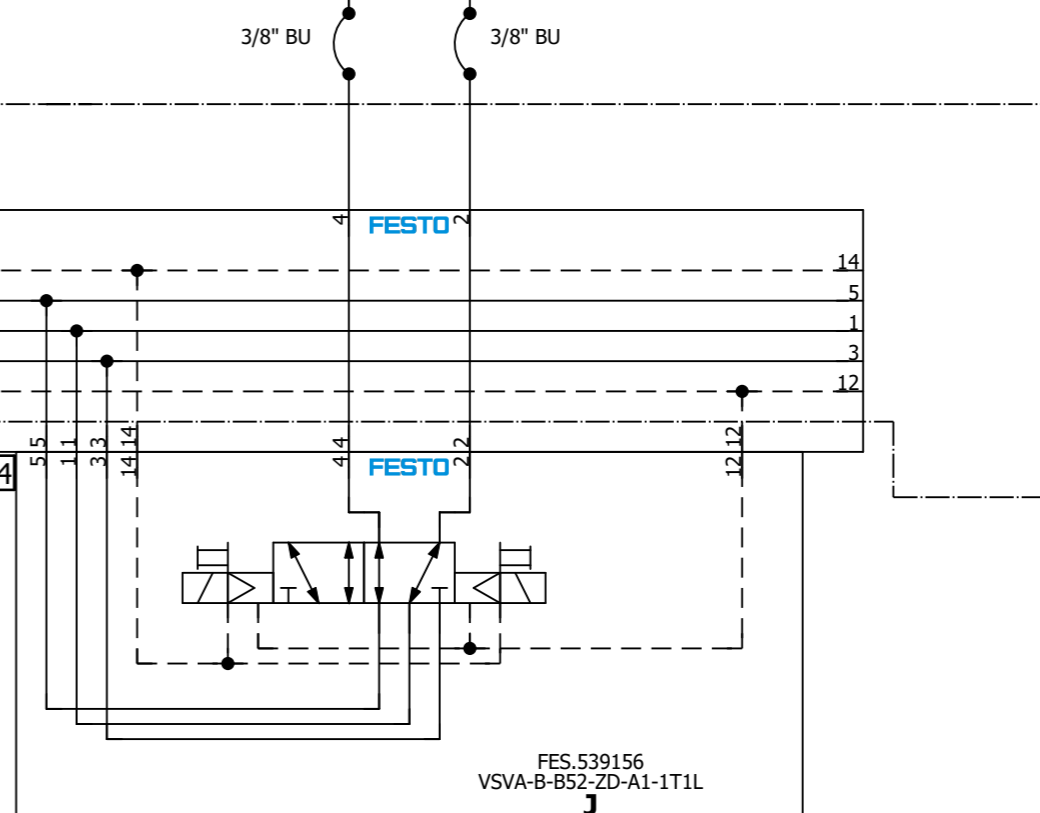

=V1UQ51  
-UQ4-QN4.1  
Common  
Clamps 1 (RST)

=V1UQ51  
-UQ4-QN4.2  
Common  
Clamps 1 (SET)

=V1UQ51UQ5/1

=V1UQ51UQ3/1

Date		12/21/2022		Volvo Trucks North America		Valiant TMS		Common Clamps 1		Drawing name: =2V04&MFS-PNEU		= V1UQ51UQ4 + V1UQ51	
Ed.		MKLEPADLO		P6700 Underbody Mainline - Cell 2V04		Scale 1:1				Document type: MFS		Project nr: 22-16151	
Appr.				Replacement of		Replaced by				Page		1	
Original										Page		227	

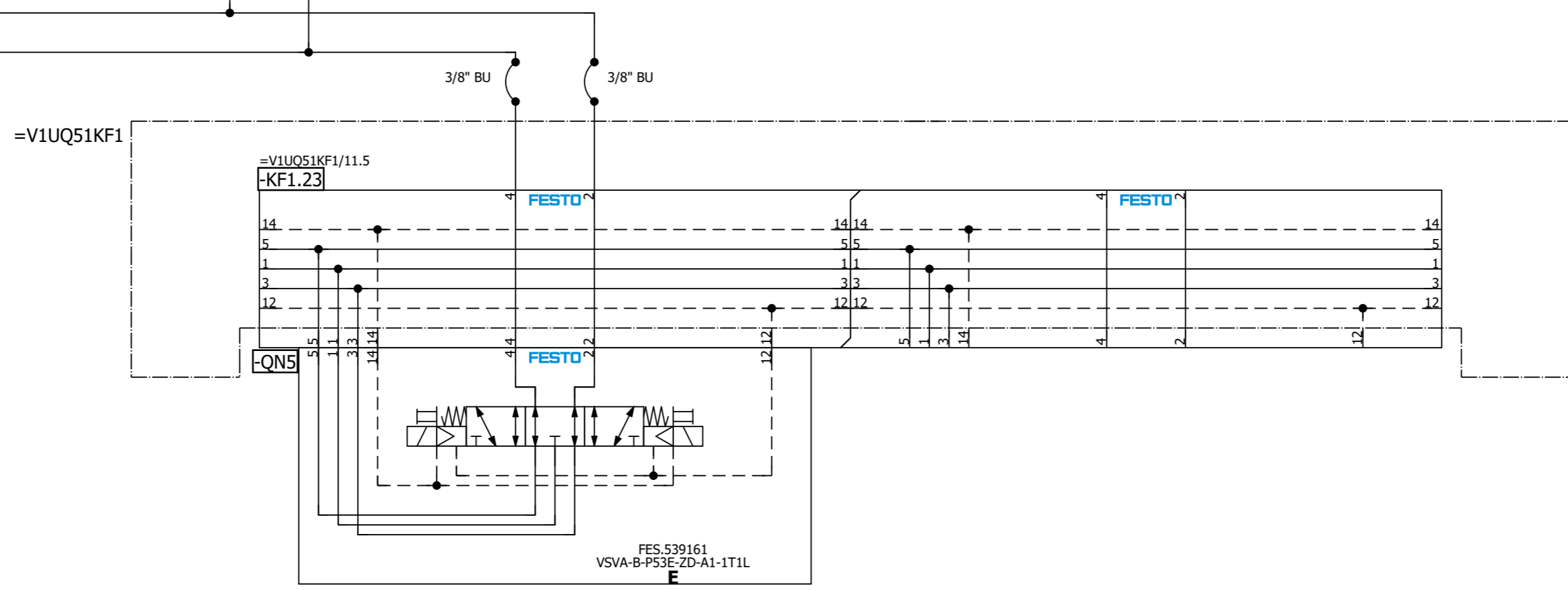
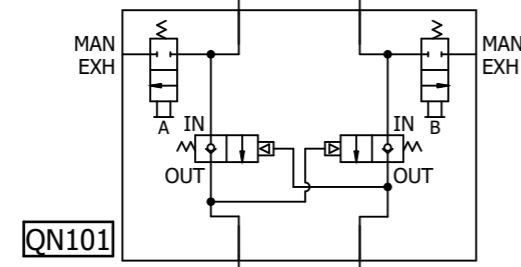
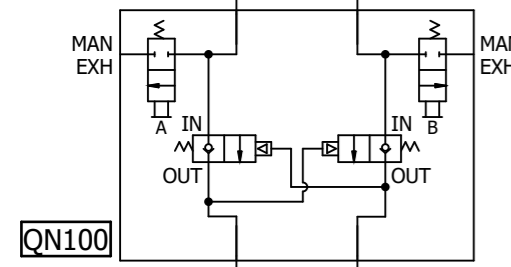
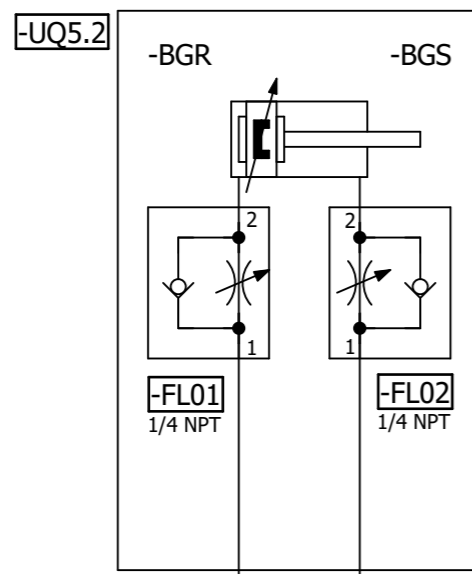
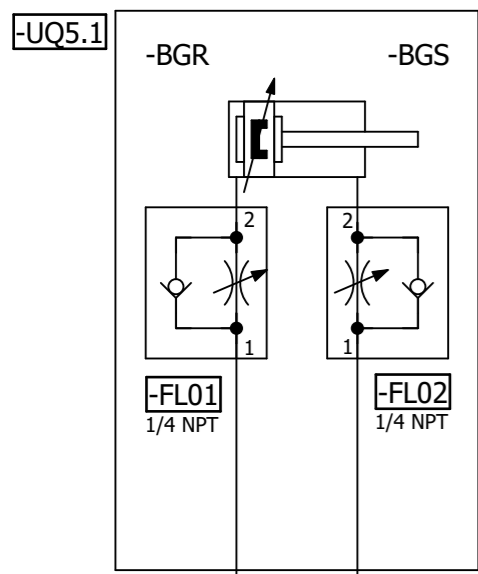

=V1UQ51  
-UQ5-QN5.1  
Common  
Y-Slides (RST)

=V1UQ51  
-UQ5-QN5.2  
Common  
Y-Slides (SET)

=V1UQ51UQ4/1

=V1UQ51UQ6/1

Date: 12/21/2022		Volvo Trucks North America		Valiant TMS		Drawing name: =2V04&MFS-PNEU		= V1UQ51UQ5	
Ed.: MKLEPADLO		P6700 Underbody Mainline - Cell 2V04		Common Y-Slides		Document type: MFS		+ V1UQ51	
Appr:		Replacement of		Replaced by		Project nr: 22-16151		Page 1	
Original								227	



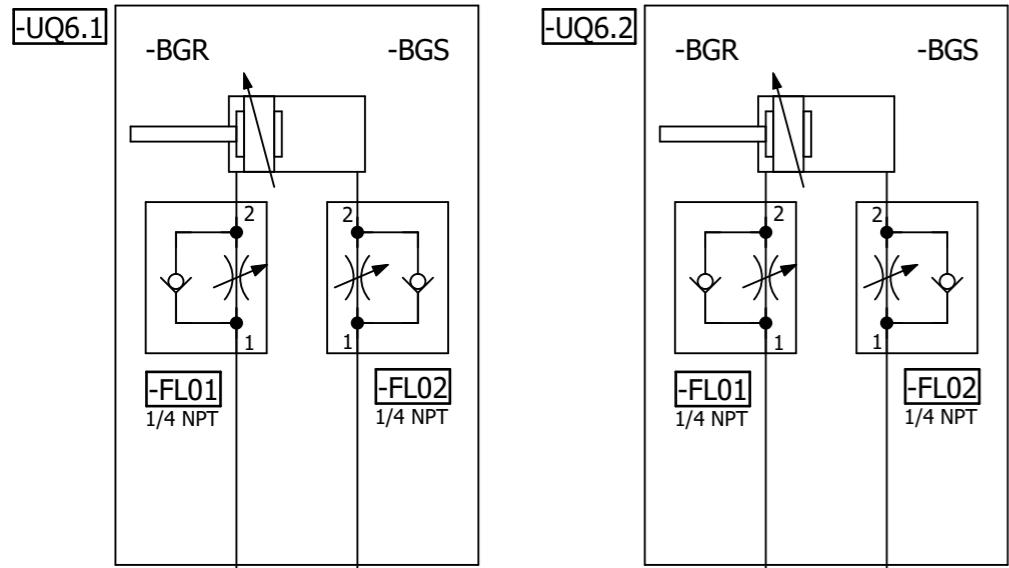

=V1UQ51KF1

=V1UQ51KF1/11.5

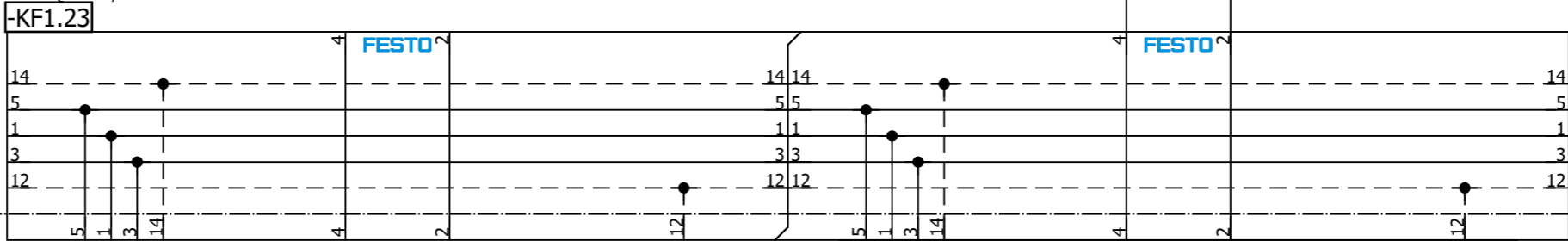

-QN6

=V1UQ51  
-UQ6-QN6.1  
Common  
Shot Pins 2 (RST)

=V1UQ51  
-UQ6-QN6.2  
Common  
Shot Pins 2 (SET)

FES.539156  
VSVA-B-B52-ZD-A1-1T1L

=V1UQ51UQ5/1

=V1UQ51UQ7/1

Date		12/21/2022	Volvo Trucks North America		Valiant TMS	Common Shot Pins 2	Drawing name:		= V1UQ51UQ6
Ed.		MKLEPADLO	P6700 Underbody Mainline - Cell 2V04				=2V04&MFS-PNEU		+ V1UQ51
Appr			Replacement of		Scale 1:1		Document type:		Project nr:
Original			Replaced by				MFS		22-16151
									227





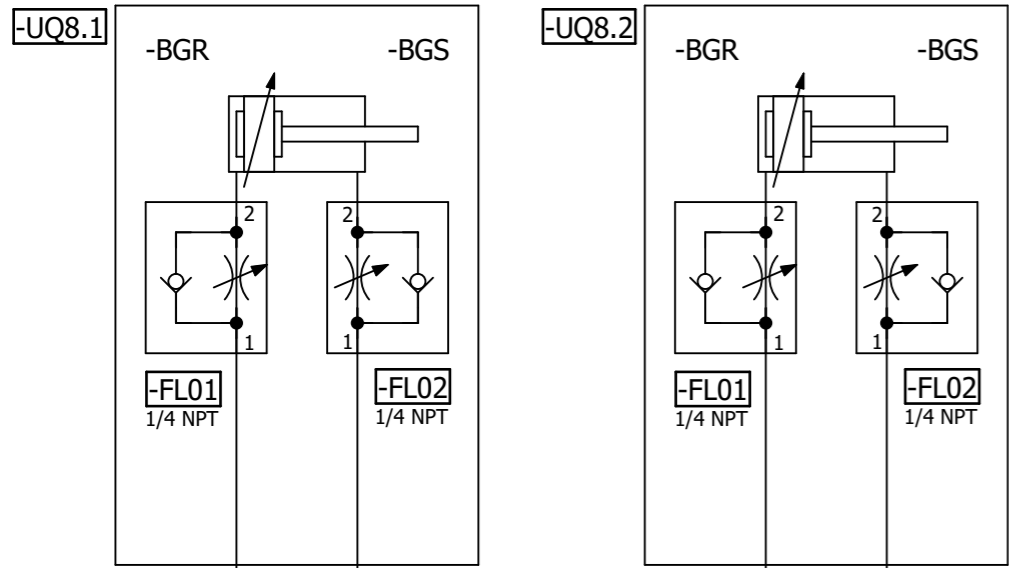

=V1UQ51KF1

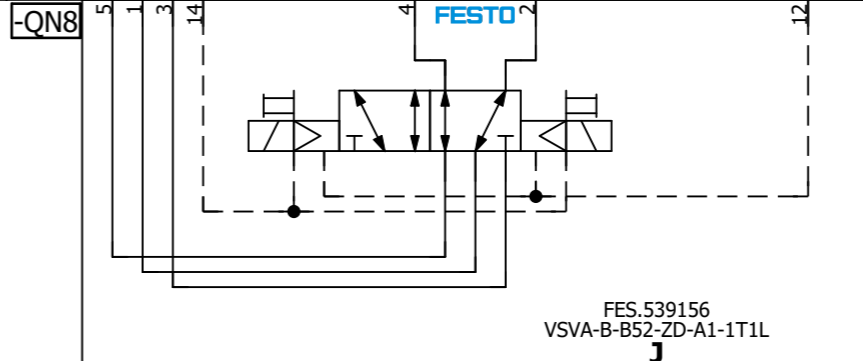
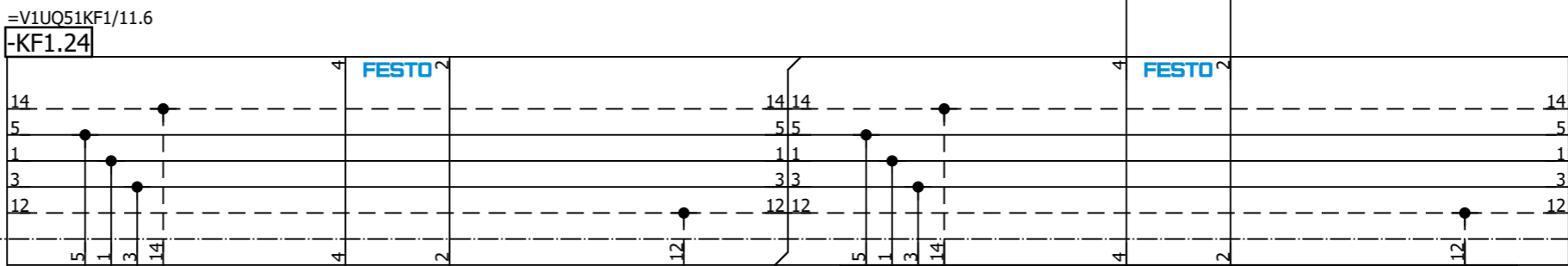

=V1UQ51  
-UQ8-QN8.1  
L150 Model  
Clamps 1 (RST)

=V1UQ51  
-UQ8-QN8.2  
L150 Model  
Clamps 1 (SET)

=V1UQ51UQ7/1

=V1UQ51UQ9/1

Date		12/21/2022	Volvo Trucks North America		Valiant TMS	L150 Model Clamps 1	Drawing name:		= V1UQ51UQ8
Ed.		MKLEPADLO	P6700 Underbody Mainline - Cell 2V04				=2V04&MFS-PNEU		+ V1UQ51
Appr			Replacement of		Scale 1:1		Document type:		Project nr:
Original			Replaced by				MFS		22-16151
Modification		Date	Name	Original					227

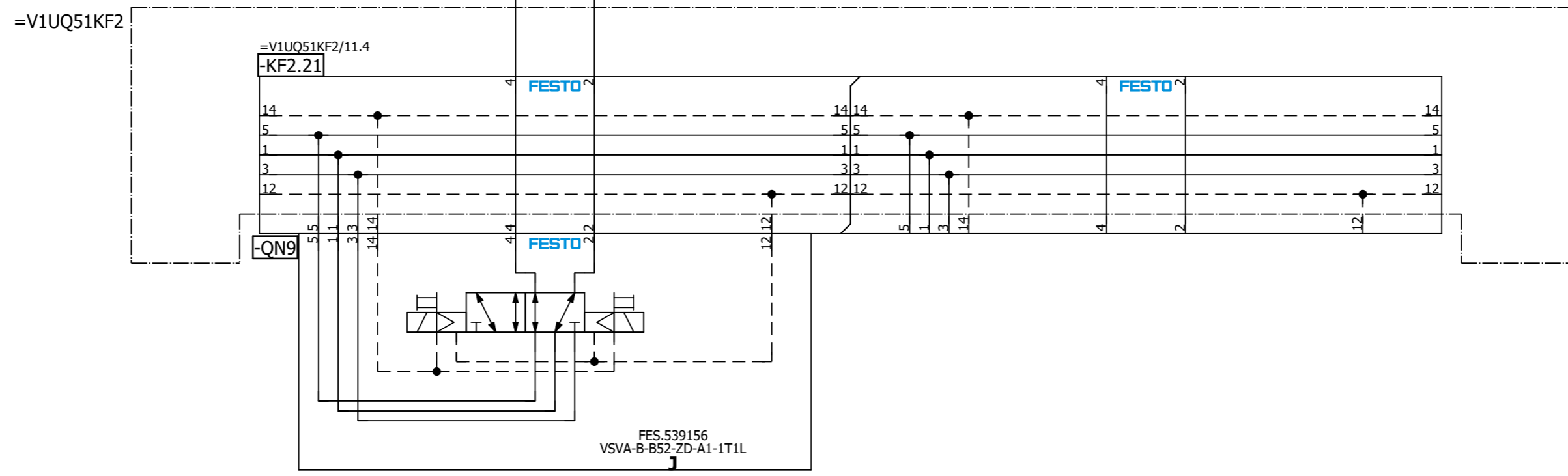
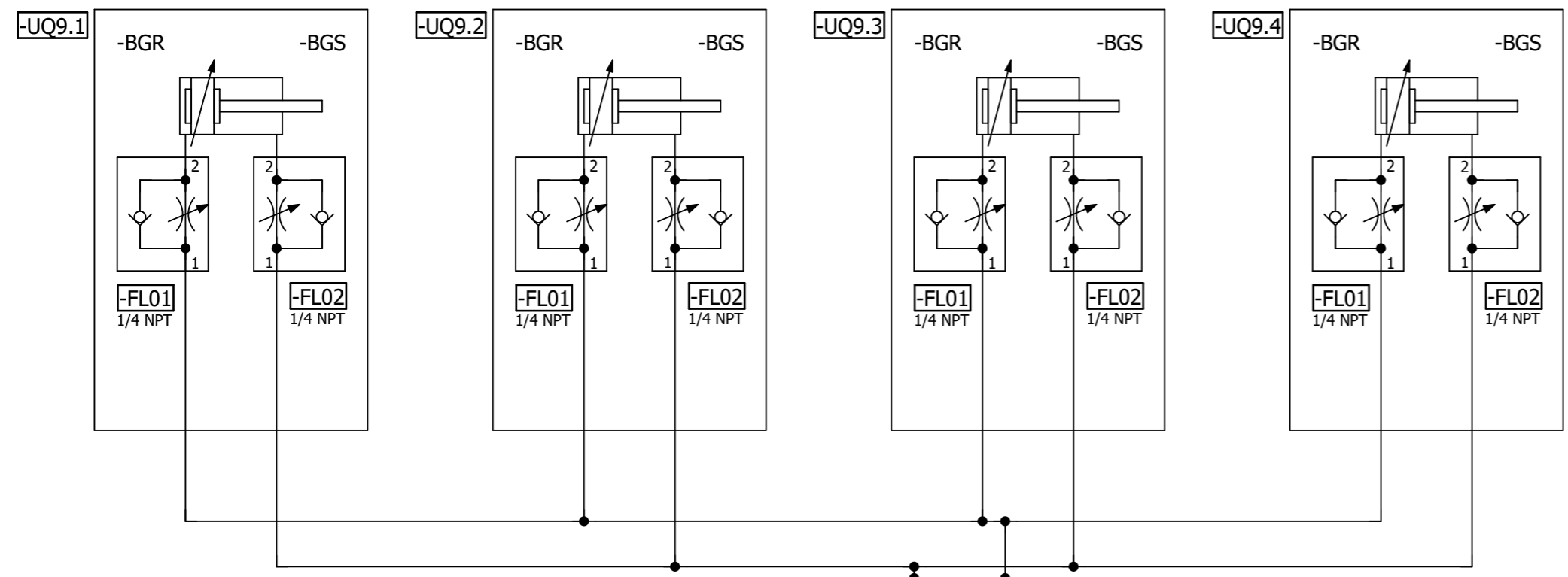

=V1UQ51  
-UQ9-QN9.1  
Common  
Clamps 3 (RST)

=V1UQ51  
-UQ9-QN9.2  
Common  
Clamps 3 (SET)

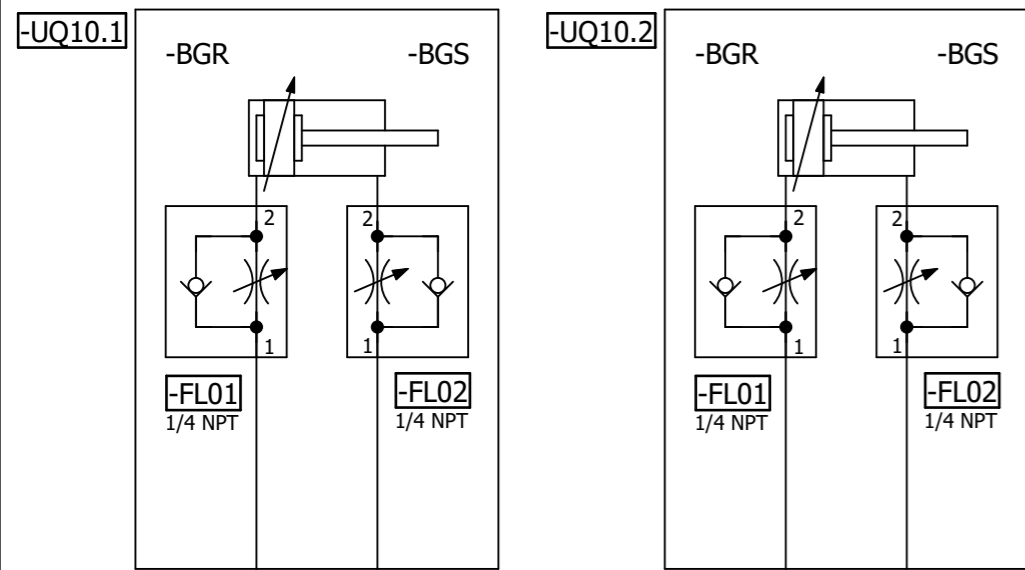

=V1UQ51KF2

=V1UQ51KF2/11.4  
-KF2.21

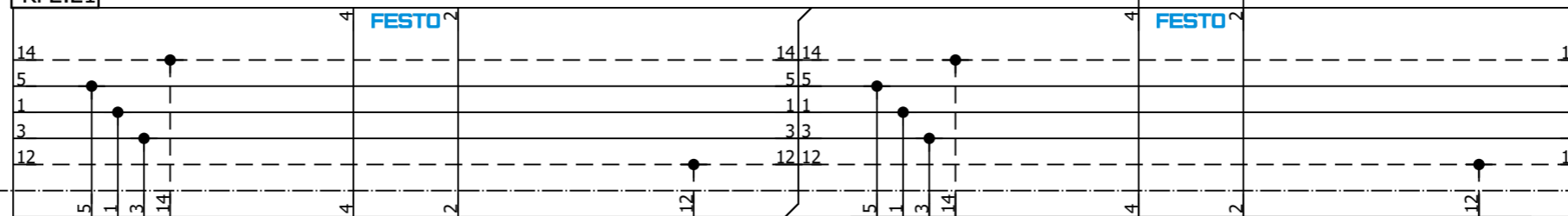

-QN10

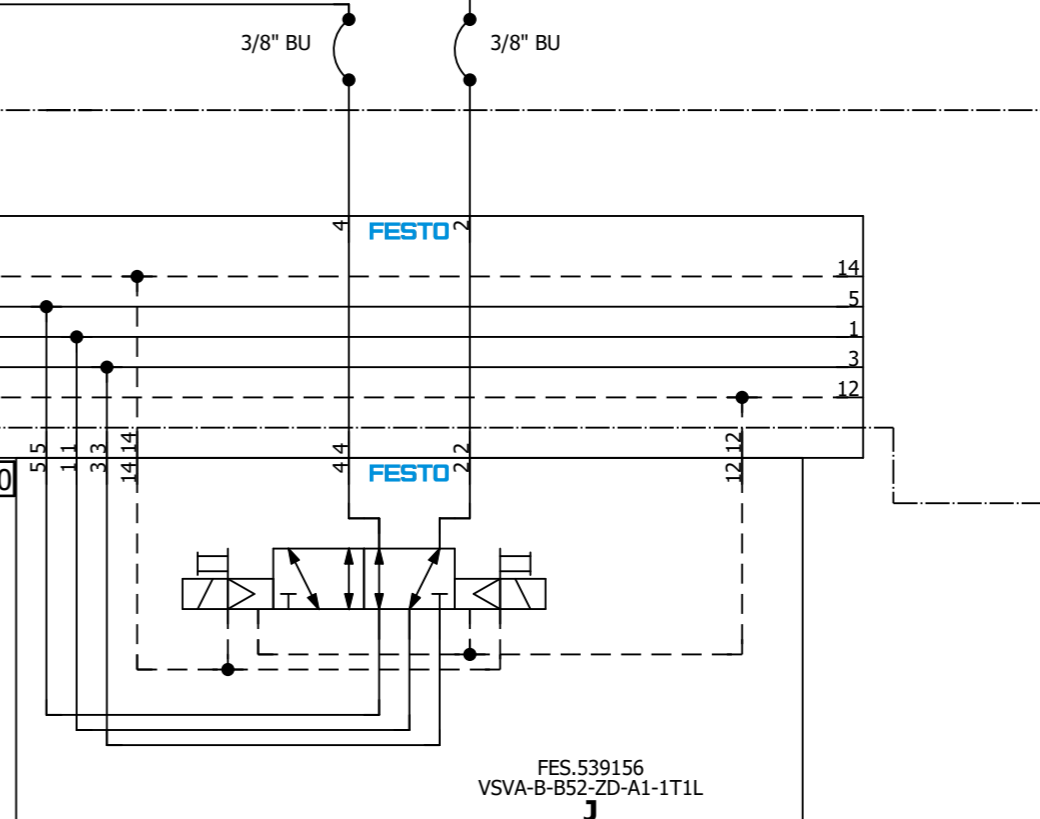

=V1UQ51  
-UQ10-QN10.1  
Common  
Clamps 4 (RST)

=V1UQ51  
-UQ10-QN10.2  
Common  
Clamps 4 (SET)

=V1UQ51UQ11/1









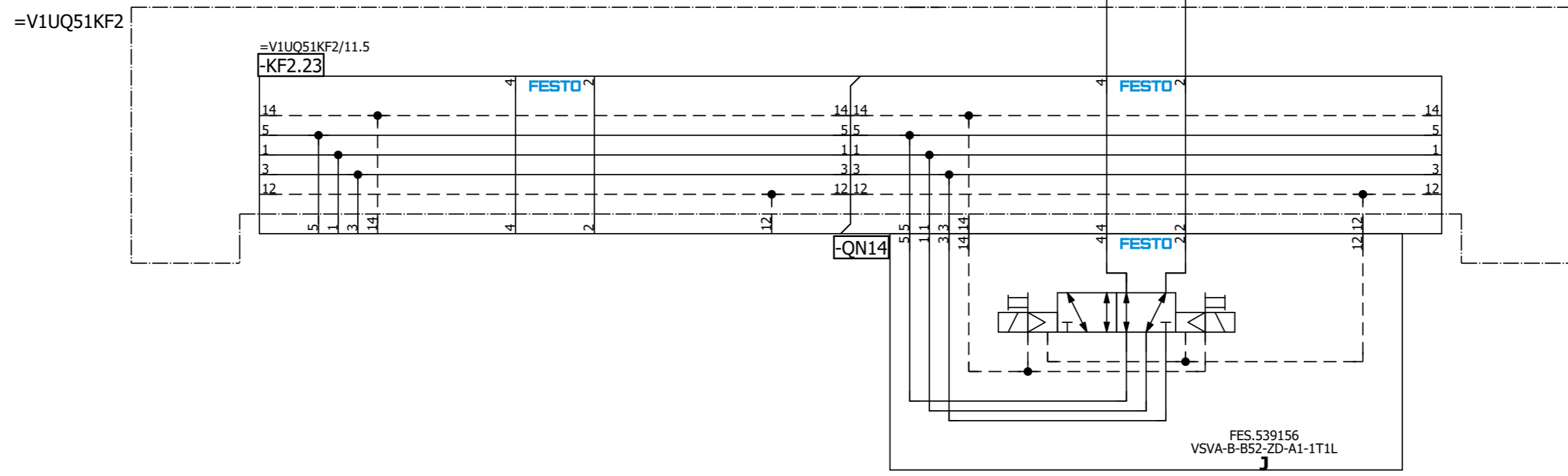
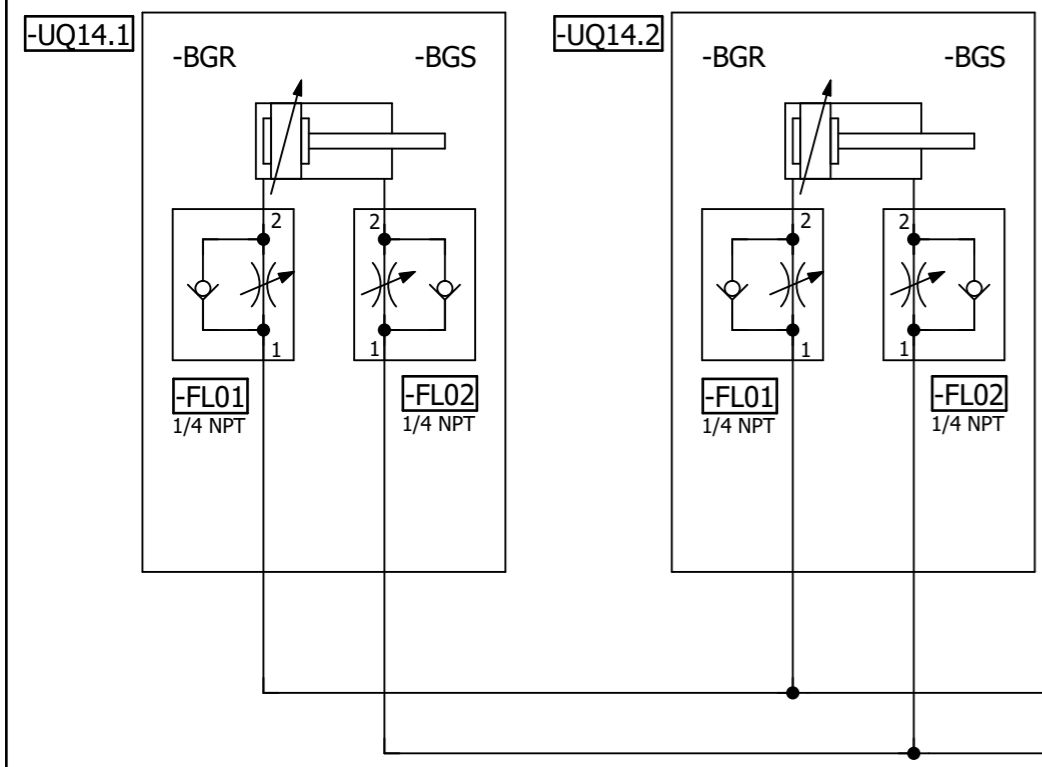

**=V1UQ51  
-UQ14-QN14.1  
L230/290 Model  
Clamps (RST)**

**=V1UQ51  
-UQ14-QN14.2  
L230/290 Model  
Clamps (SET)**

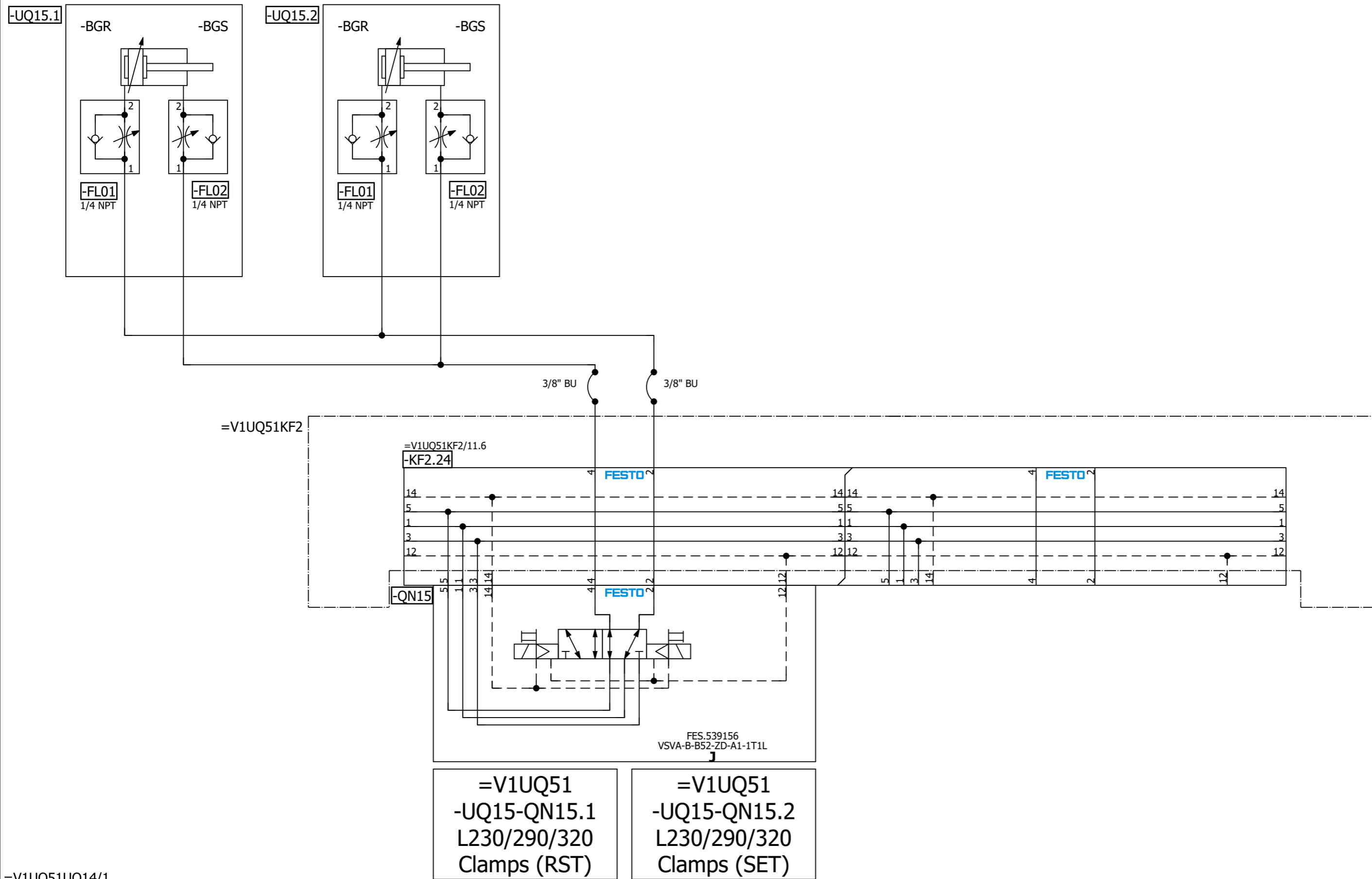

=V1UQ51UQ14/1

=V1UQ51UQ16/1

Date		12/21/2022	Volvo Trucks North America		Valiant TMS	L230/290/320 Model Clamps	Drawing name:		= V1UQ51UQ15
Ed.		MKLEPADLO	P6700 Underbody Mainline - Cell 2V04				=2V04&MFS-PNEU		+ V1UQ51
Appr			Replacement of		Scale 1:1		Document type:		MFS
Original			Replaced by				Project nr:		22-16151
Modification	Date	Name	Original				Page		1
									227

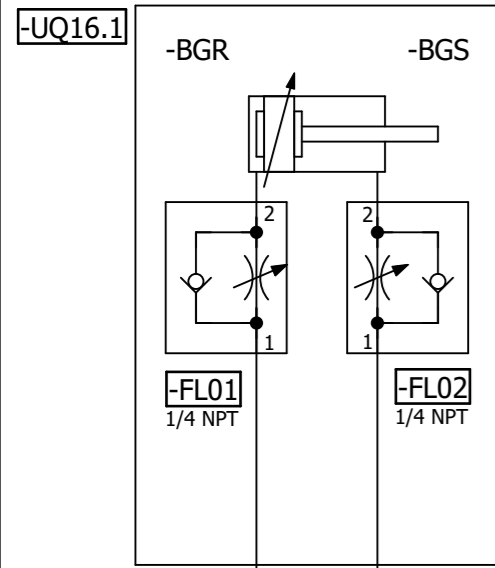

=V1UQ51KF2

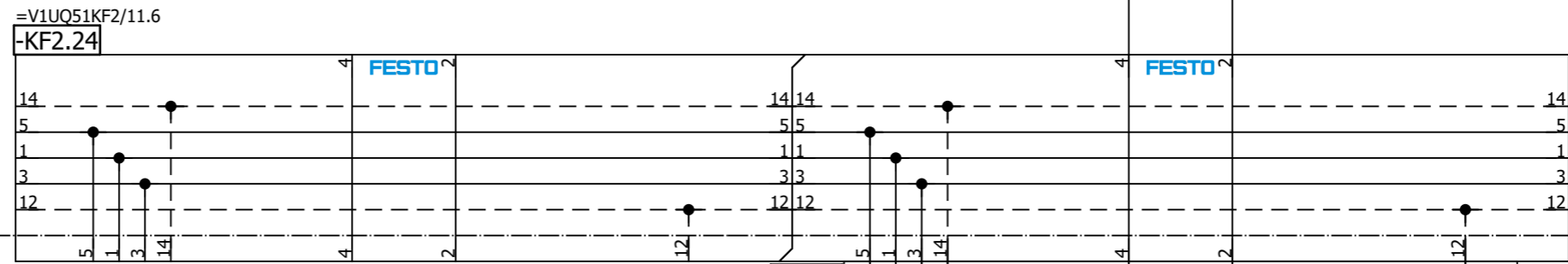

-QN16

FESTO

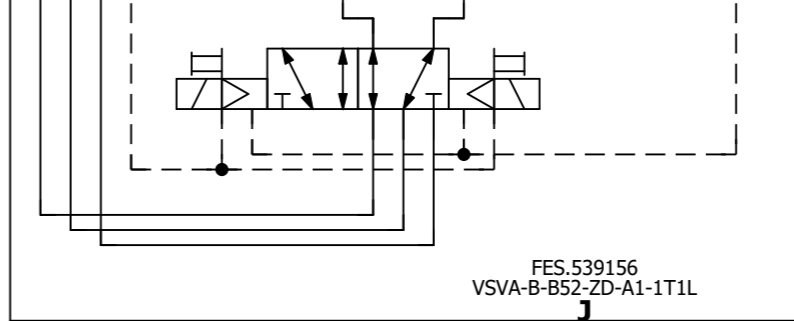

FES.539156  
VSVA-B-B52-ZD-A1-1T1L

=V1UQ51  
-UQ16-QN16.1  
L230 Model  
Clamp (RST)

=V1UQ51  
-UQ16-QN16.2  
L230 Model  
Clamp (SET)

=V1UQ51UQ17/1

=V1UQ51UQ15/1

Date		12/21/2022	Volvo Trucks North America		Valiant TMS	L230 Model Clamp	Drawing name:		= V1UQ51UQ16
Ed.		MKLEPADLO	P6700 Underbody Mainline - Cell 2V04				=2V04&MFS-PNEU		+ V1UQ51
Appr			Replacement of		Scale 1:1		Document type:		Page
Original			Replaced by				MFS		Project nr:
Modification		Date	Name	Original			22-16151		227

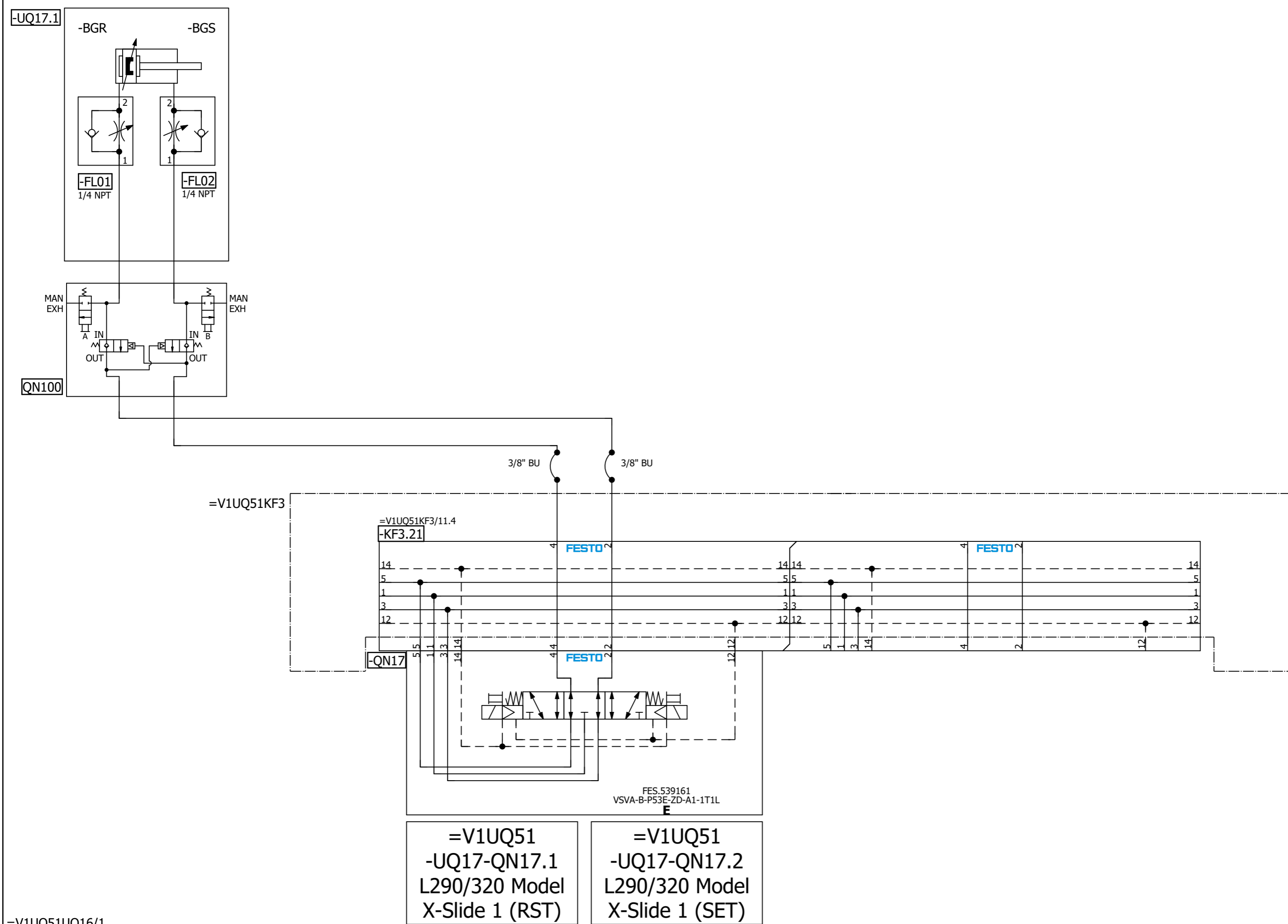

=V1UQ51UQ16/1

=V1UQ51UQ18/1

Date: 12/21/2022		Volvo Trucks North America		Valiant TMS		L290/320 Model X-Slide 1		Drawing name: =V1UQ51UQ17		= V1UQ51UQ17	
Ed.: MKLEPADLO		P6700 Underbody Mainline - Cell 2V04				Scale 1:1		Document type: MFS		Project nr: 22-16151	
Appr:		Replacement of						Replaced by		Page 1	

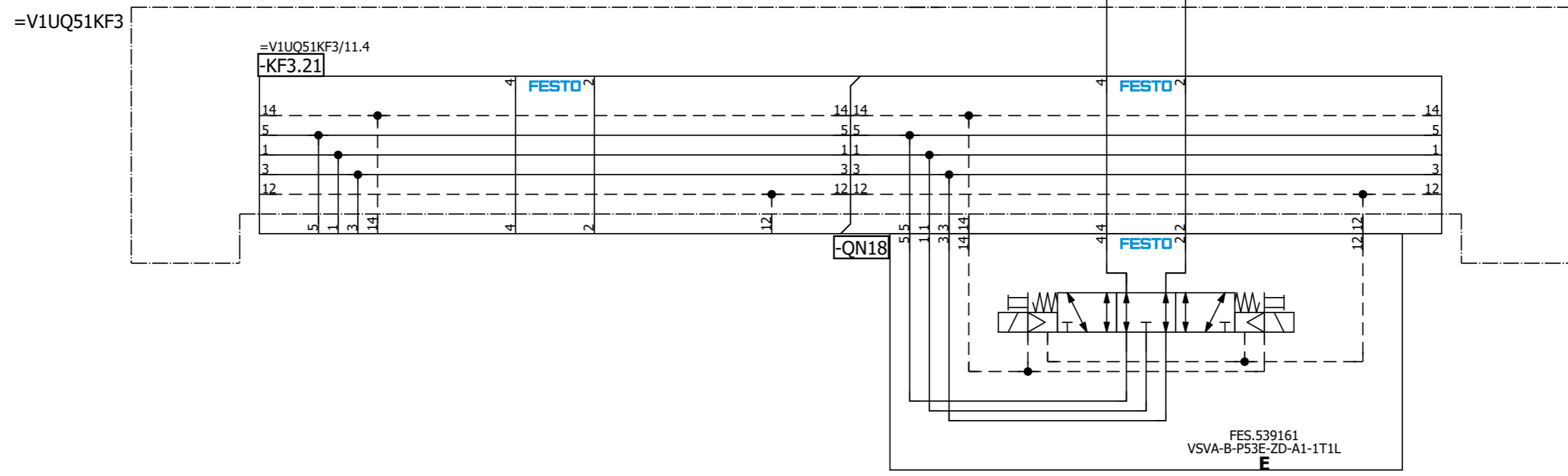
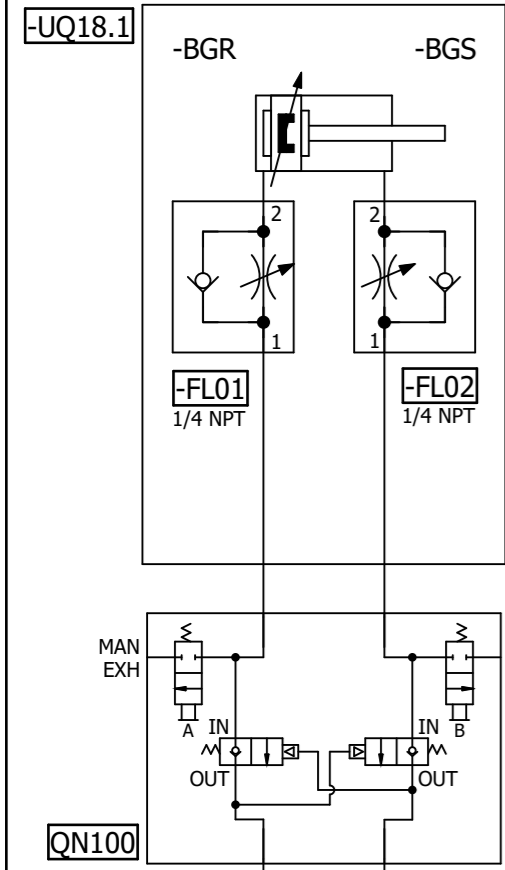

**=V1UQ51**  
**-UQ18-QN18.1**  
**L290/320 Model**  
**X-Slide 2 (RST)**

**=V1UQ51**  
**-UQ18-QN18.2**  
**L290/320 Model**  
**X-Slide 2 (SET)**



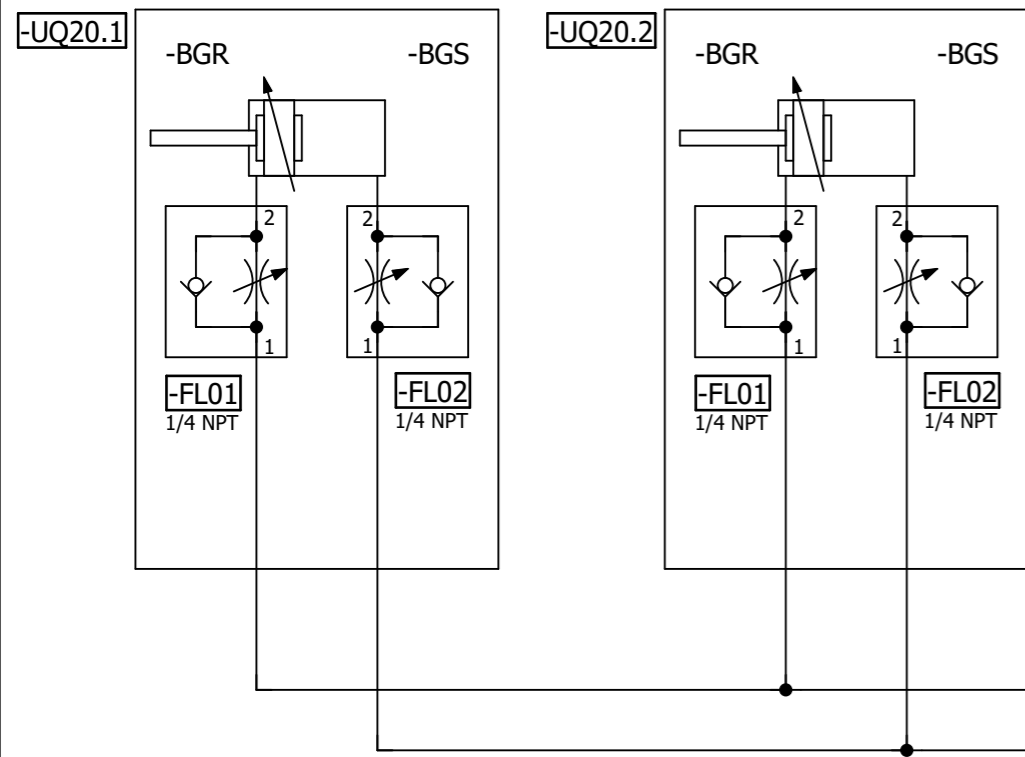

=V1UQ51KF3

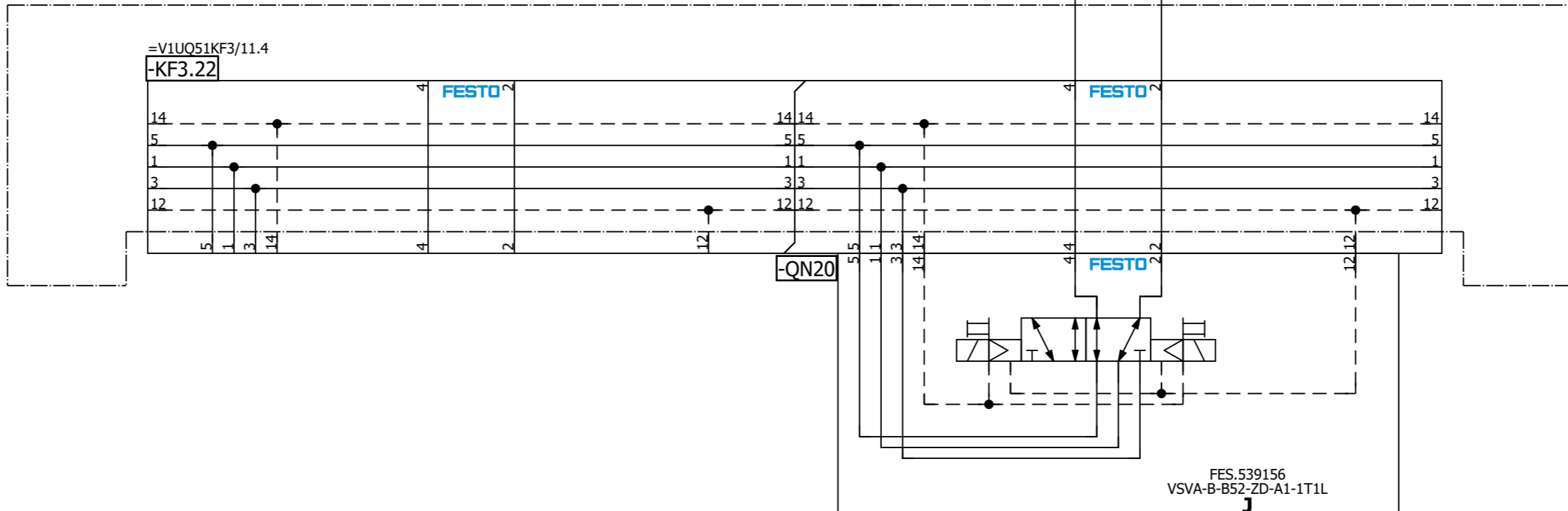

=V1UQ51  
-UQ20-QN20.1  
L320 Model  
Shot Pins (RST)

=V1UQ51  
-UQ20-QN20.2  
L320 Model  
Shot Pins (SET)

=V1UQ51UQ19/1

=V1UQ51UQ21/1

Date		12/21/2022	Volvo Trucks North America		Valiant TMS	L320 Model Shot Pins	Drawing name:		= V1UQ51UQ20
Ed.		MKLEPADLO	P6700 Underbody Mainline - Cell 2V04				=2V04&MFS-PNEU		+ V1UQ51
Appr			Replacement of		Scale 1:1		Document type:		Project nr:
Modification	Date	Name	Original	Replaced by			MFS	22-16151	Page
									227





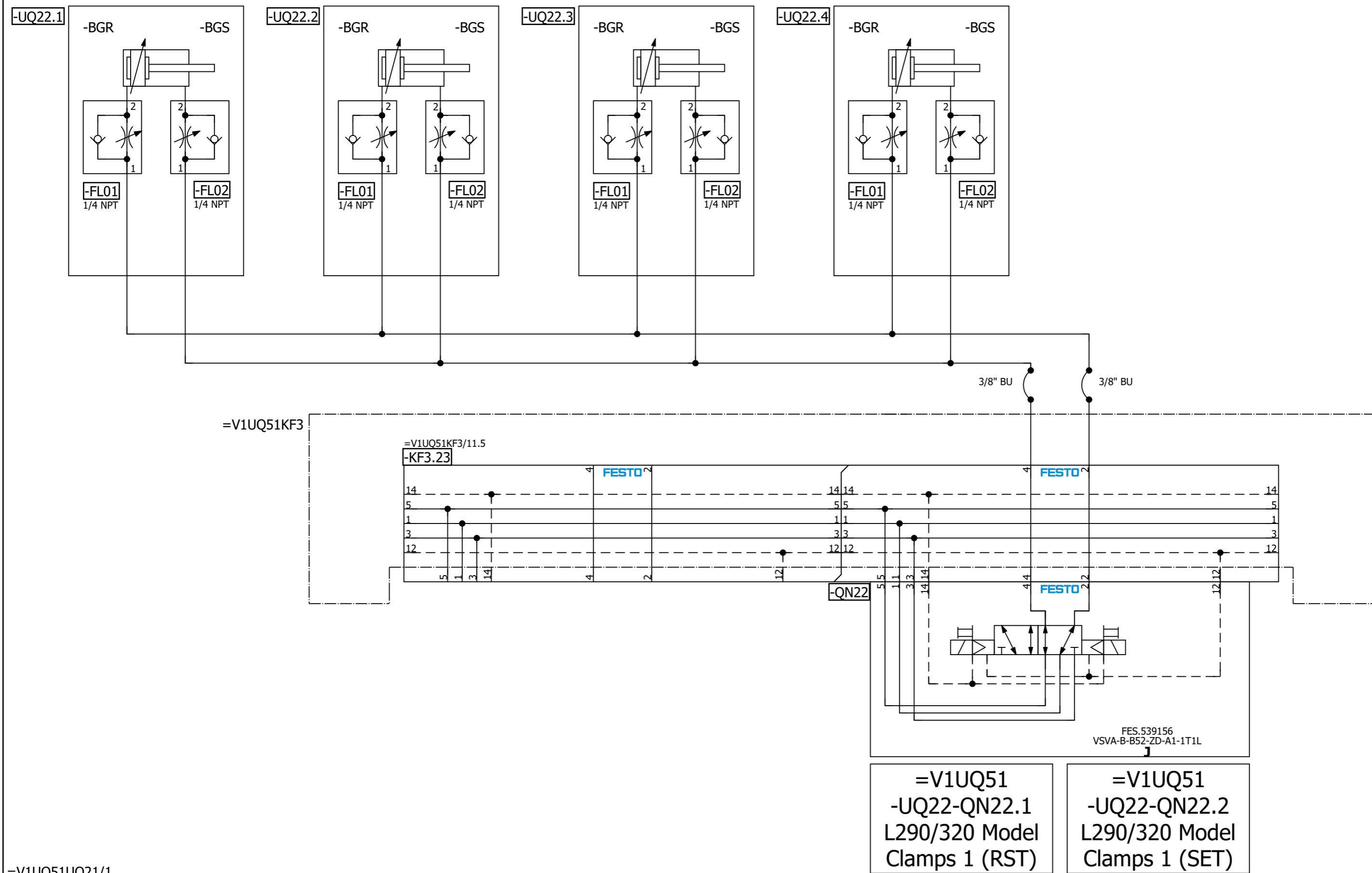

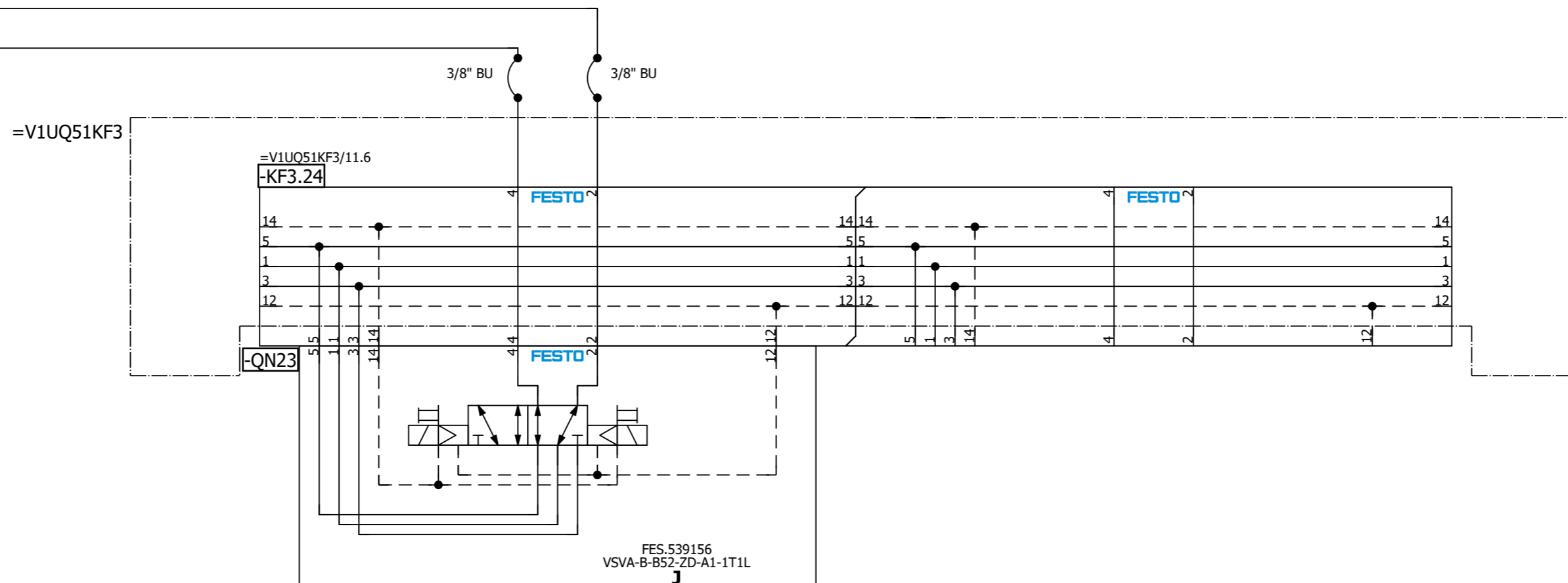
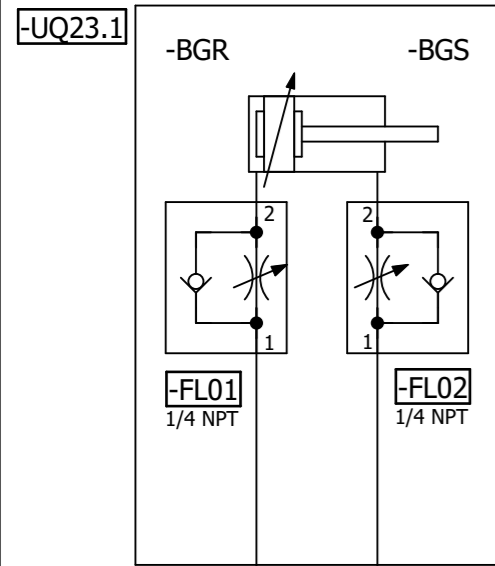

=V1UQ51  
-UQ23-QN23.1  
L290 Model  
Clamp 3 (RST)

=V1UQ51  
-UQ23-QN23.2  
L290 Model  
Clamp 3 (SET)

=V1UQ51UQ22/1

=V1UQ51UQ24/1

Date		12/21/2022	Volvo Trucks North America		Valiant TMS	L290 Model Clamp 3	Drawing name:		= V1UQ51UQ23	
Ed.		MKLEPADLO	P6700 Underbody Mainline - Cell 2V04				Document type:		MFS	= 2V04&MFS-PNEU
Appr			Replacement of		Scale 1:1	Project nr:		22-16151	Page	1
Original			Replaced by			Document type:		MFS	227	



A2

=KH0+KH0/1.7 / +V1UQ52KH1-P1

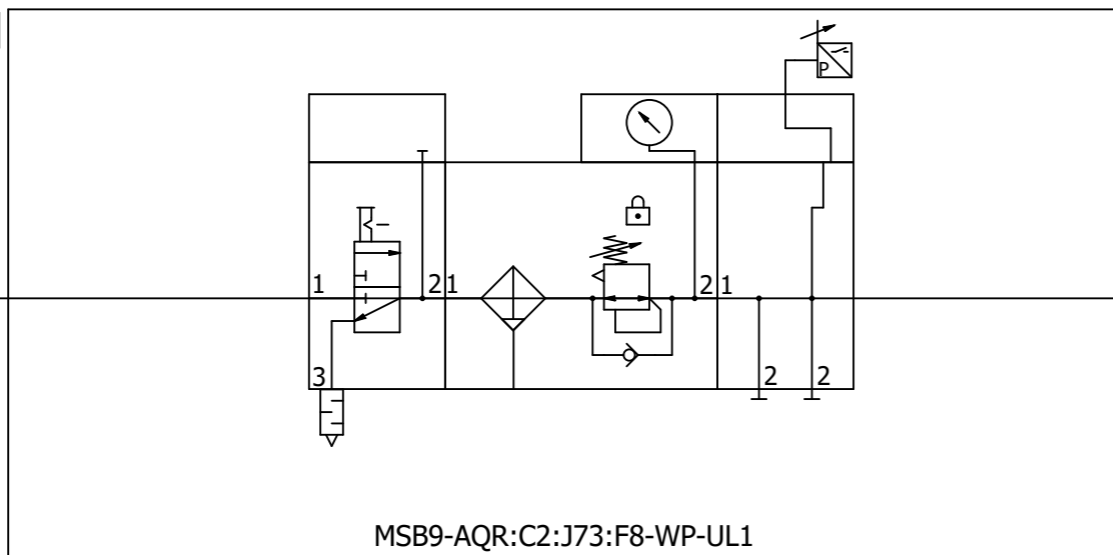

1/2"

+V1UQ52-P1 / =V1UQ52KF1+V1UQ52/11.0

=V1UQ51UQ24+V1UQ51/1

=V1UQ52KF1+V1UQ52/5

		Date	12/21/2022	Volvo Trucks North America			Valiant TMS	Incoming air supply (Fixture)	Drawing name:		= V1UQ52			
		Ed.	MKLEPADLO	P6700 Underbody Mainline - Cell 2V04						=2V04&MFS-PNEU		+ KH1		
		Appr		Replacement of		Replaced by	Scale 1:1	Document type:		MFS	Project nr:	22-16151	Page	1
Modification	Date	Name	Original											227

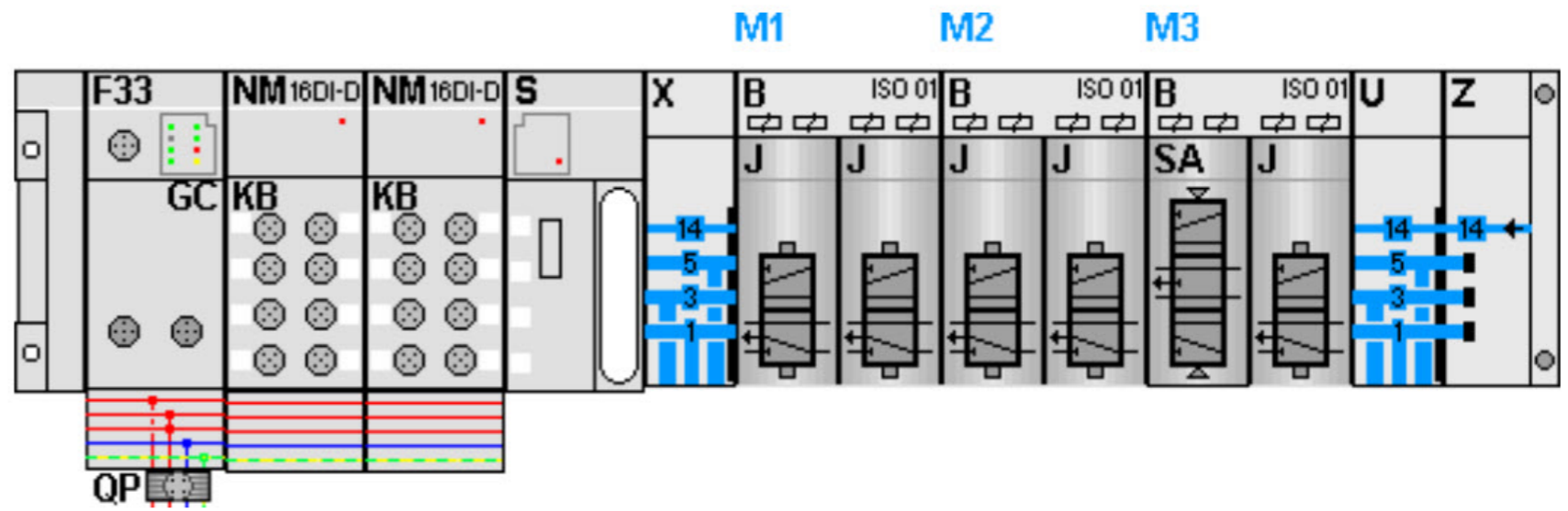

KF1.0

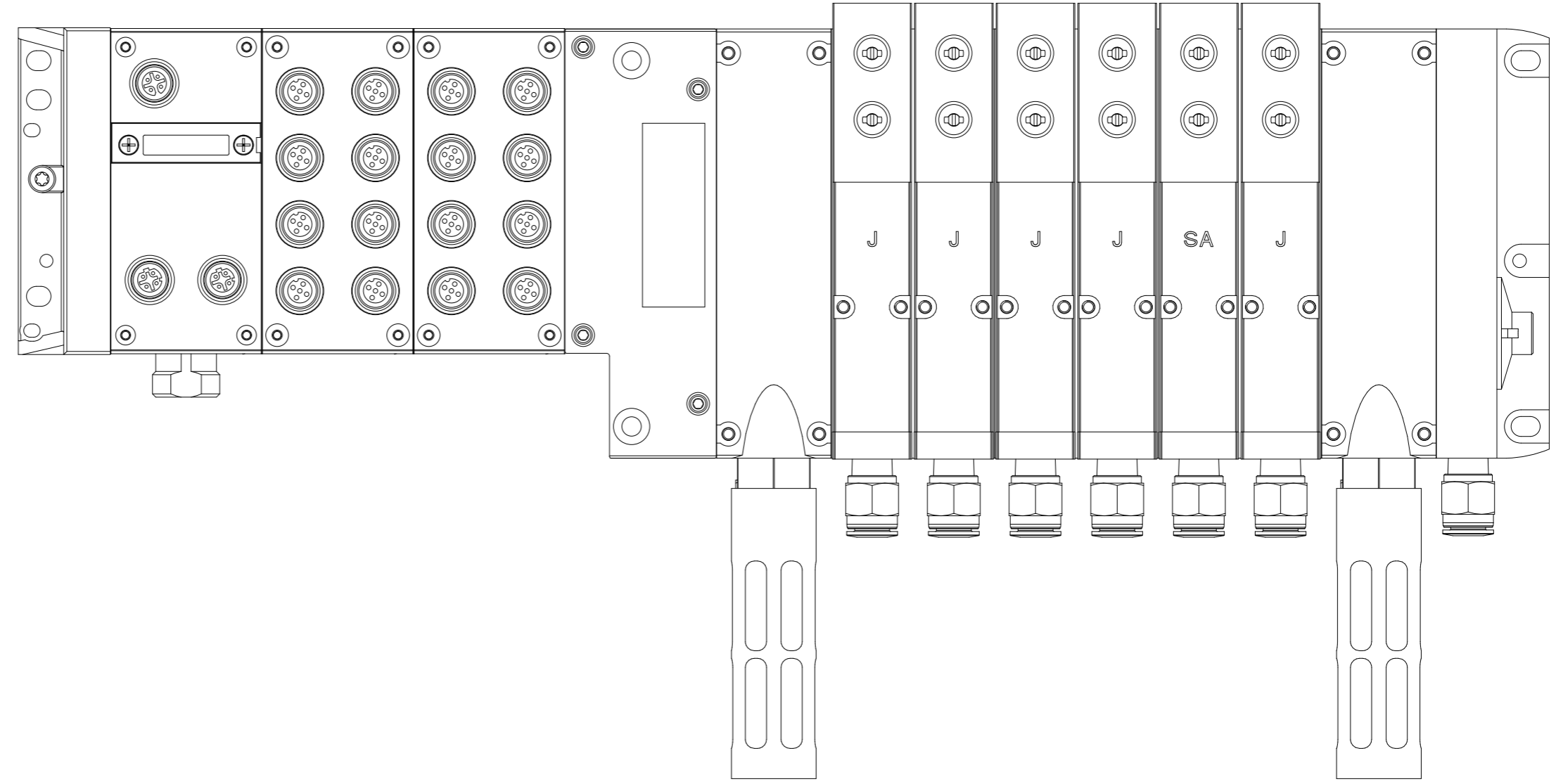

=V1UQ52+KH1/1

Date		12/21/2022		Volvo Trucks North America		Valiant TMS		AIR SUPPLY CONFIGURATION		Drawing name:		= V1UQ52KF1	
Ed.		MKLEPADLO		P6700 Underbody Mainline - Cell 2V04		Scale 1:1				= 2V04&MFS-PNEU		+ V1UQ52	
Appr				Replacement of		Replaced by				Document type:		Project nr:	
Original										MFS		22-16151	
Modification		Date		Name								Page	
												5	
												227	



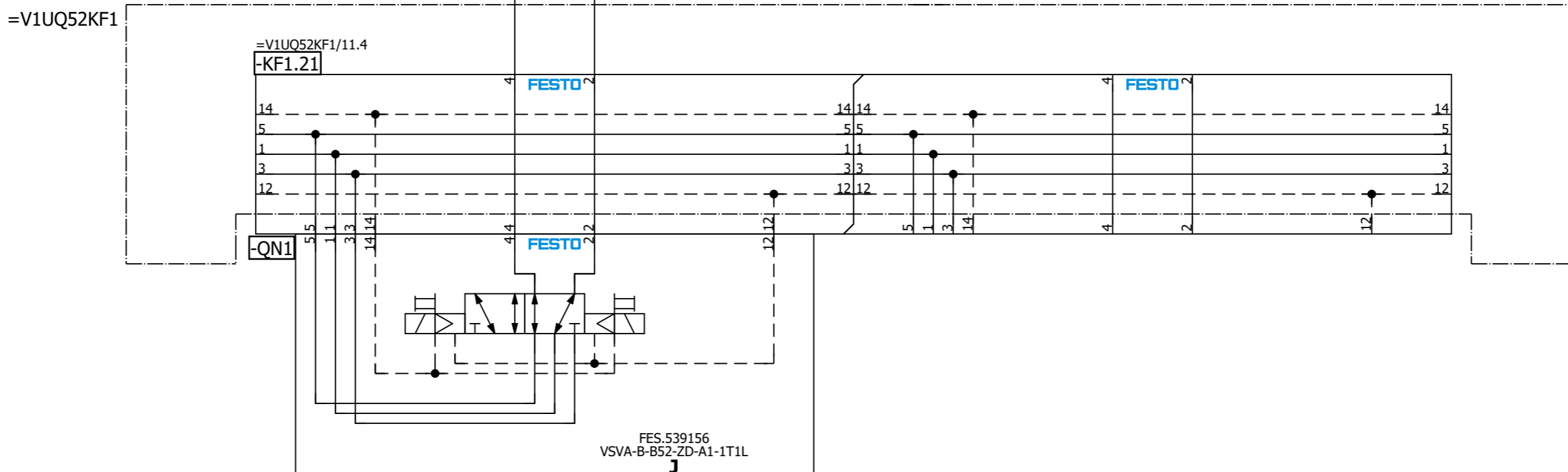
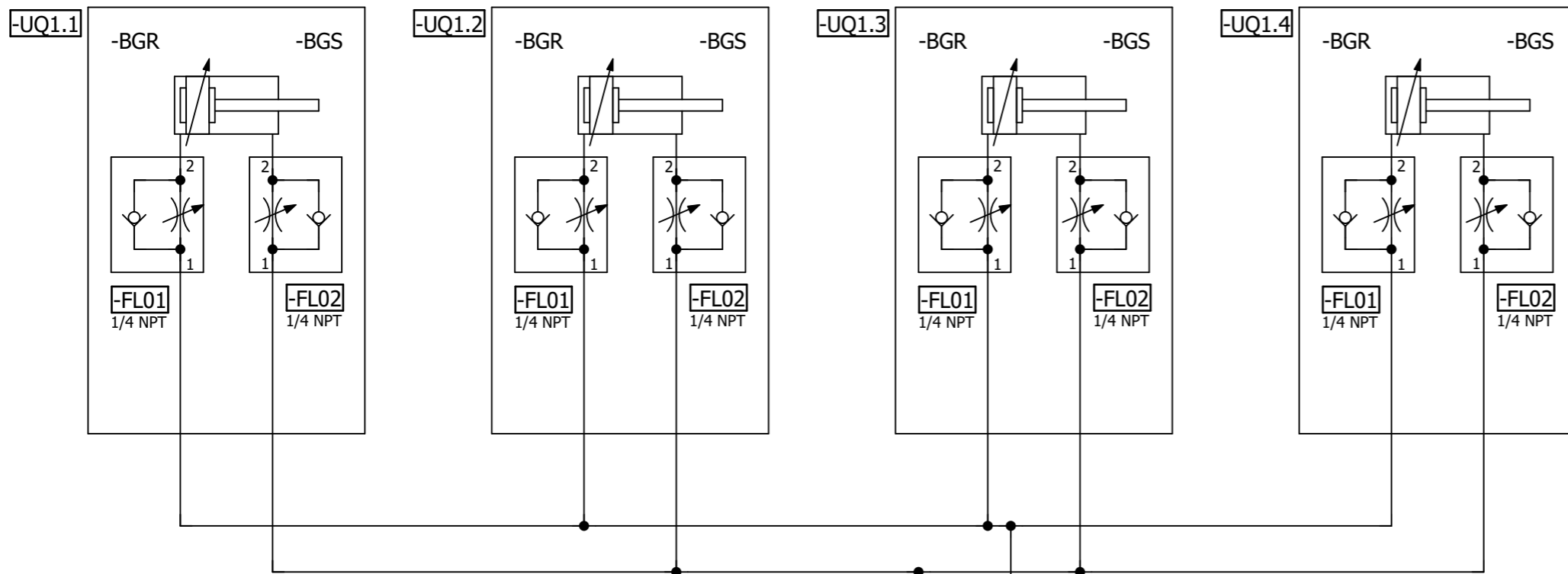

=V1UQ52  
-UQ1-QN1.1  
Common  
Clamps (RST)

=V1UQ52  
-UQ1-QN1.2  
Common  
Clamps (SET)

=V1UQ52KF1/11

=V1UQ52UQ2/1

Date: 12/21/2022		Volvo Trucks North America		Valiant TMS		Drawing name: =2V04&MFS-PNEU		= V1UQ52UQ1	
Ed.: MKLEPADLO		P6700 Underbody Mainline - Cell 2V04		Common Clamps		Document type: MFS		+ V1UQ52	
Appr.:		Replacement of:		Scale 1:1		Project nr: 22-16151		Page 1	
Original:		Replaced by:						227	

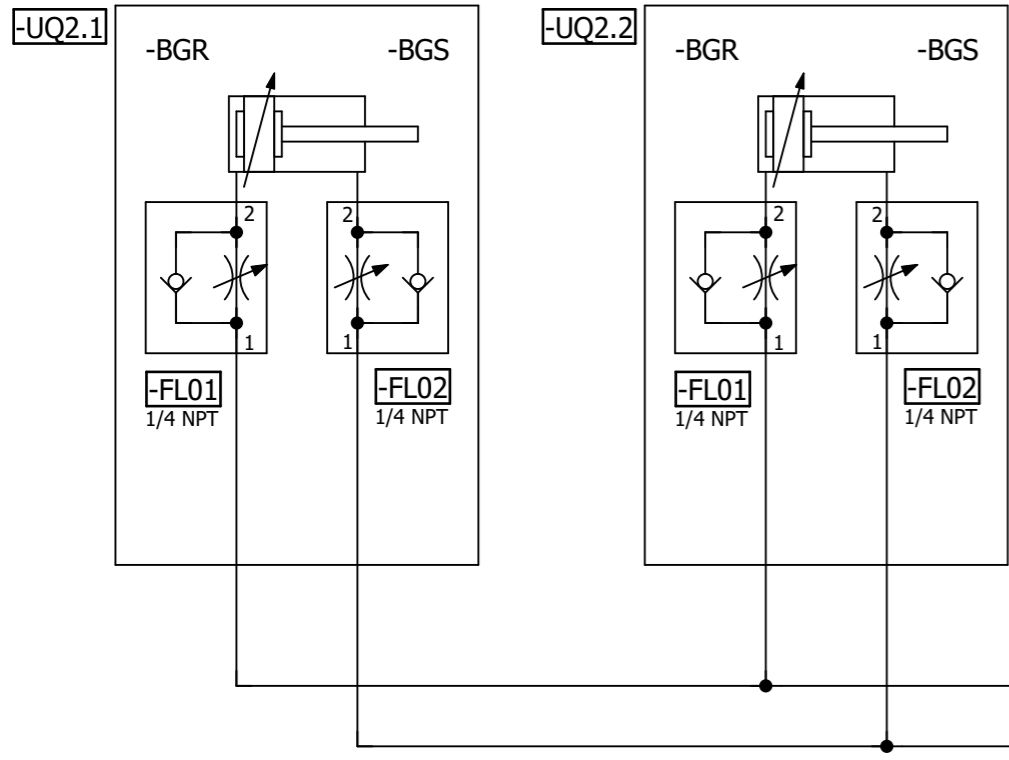

=V1UQ52KF1

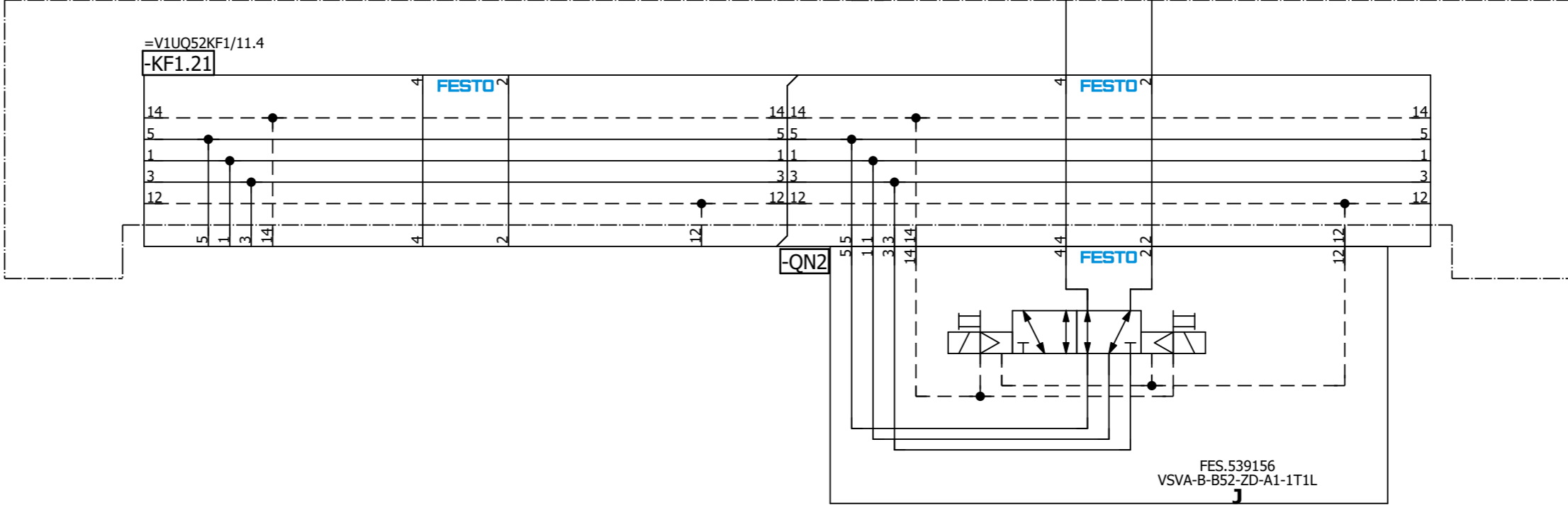

=V1UQ52  
-UQ2-QN2.1  
L150 Model  
Clamps (RST)

=V1UQ52  
-UQ2-QN2.2  
L150 Model  
Clamps (SET)

=V1UQ52UQ1/1

=V1UQ52UQ3/1





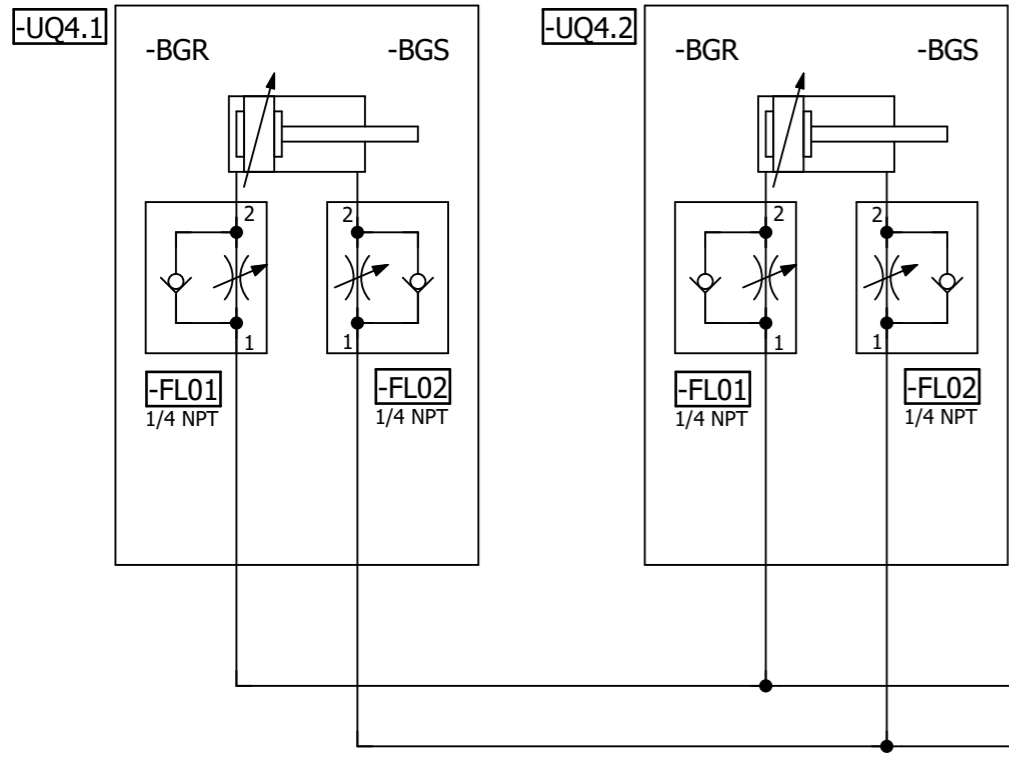

=V1UQ52KF1

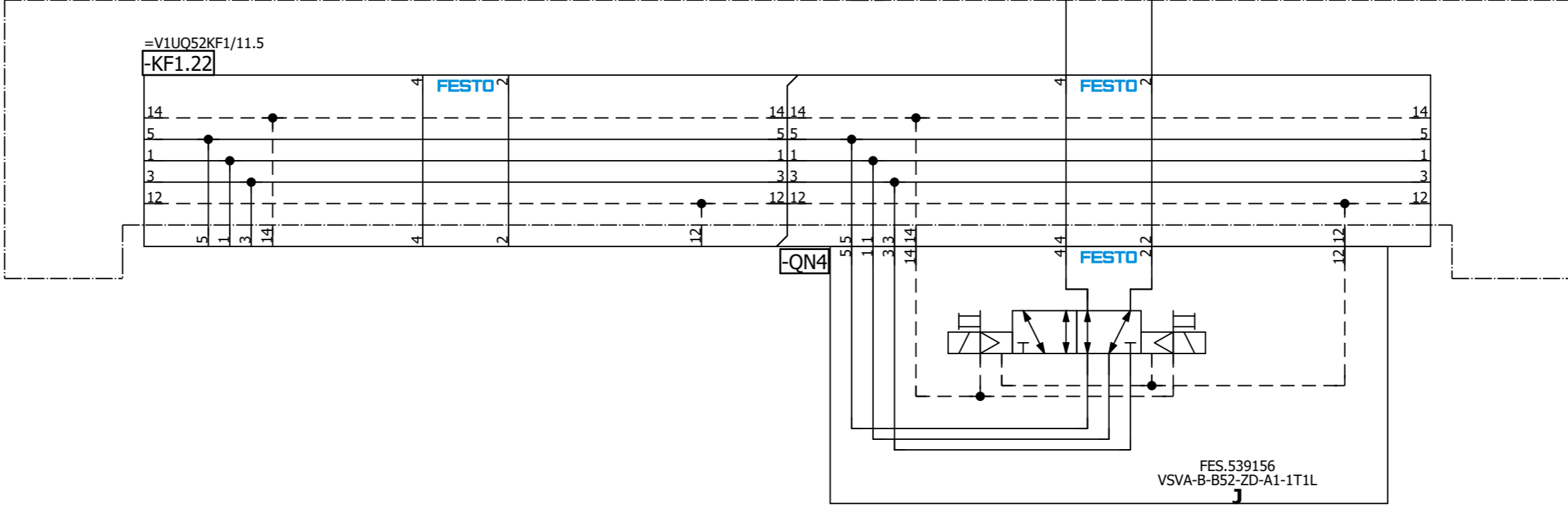

=V1UQ52  
-UQ4-QN4.1  
L230/290/320  
Clamps (RST)

=V1UQ52  
-UQ4-QN4.2  
L230/290/320  
Clamps (SET)

=V1UQ52UQ3/1

=V1UQ52UQ5/1

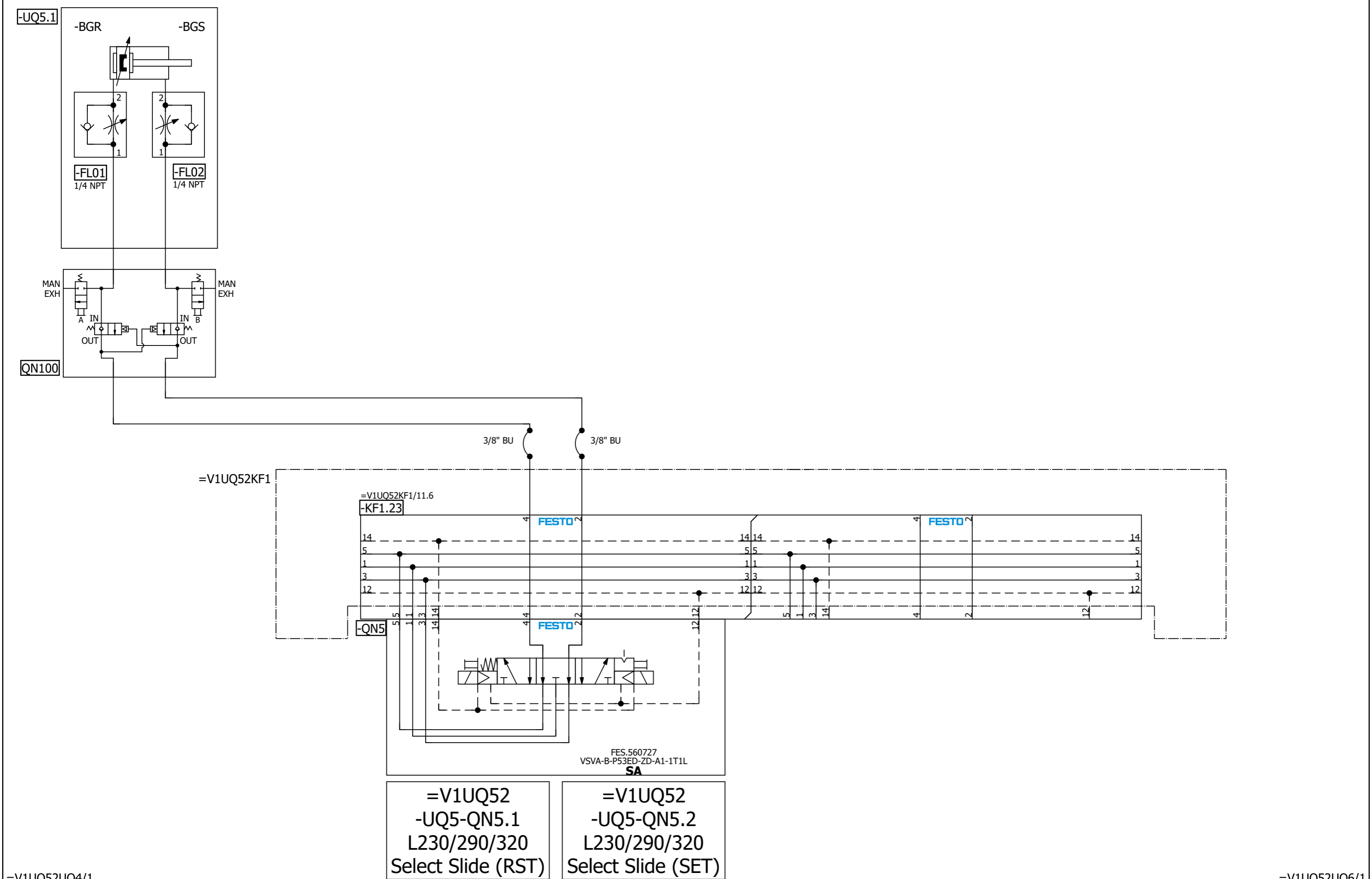

=V1UQ52UQ4/1		Date: 12/21/2022		Volvo Trucks North America		Valiant TMS		L230/290/320 Mod Select Slide		Drawing name: =V1UQ52UQ5		= V1UQ52UQ5	
		Ed. MKLEPADLO		P6700 Underbody Mainline - Cell 2V04		Scale 1:1				Document type: MFS		Project nr: 22-16151	
Modification		Date		Name		Original		Replacement of		Replaced by		Page 1	
												227	

=V1UQ52UQ6/1

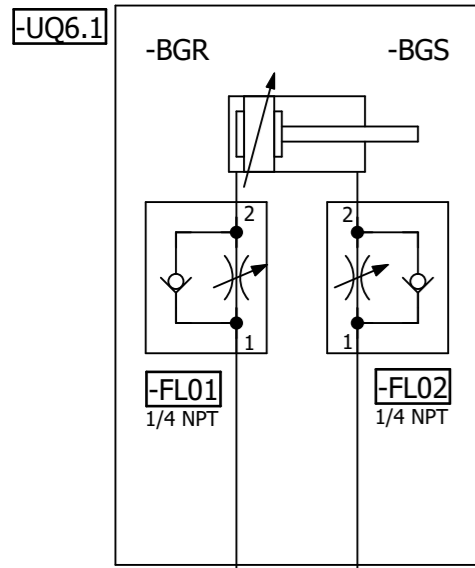

=V1UQ52KF1

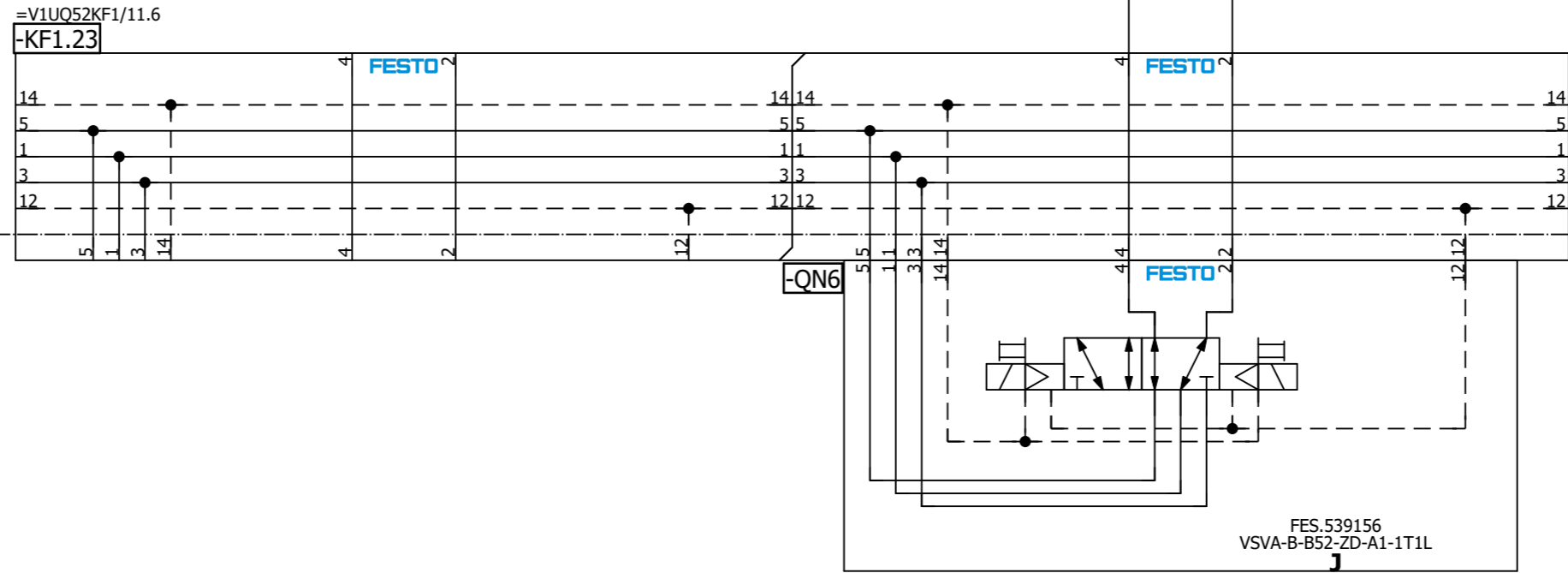

=V1UQ52  
-UQ6-QN6.1  
L290 Slide Lock  
Clamp (RST)

=V1UQ52  
-UQ6-QN6.2  
L290 Slide Lock  
Clamp (SET)

=V1UQ53+KH1/1

=V1UQ52UQ5/1		Date	12/21/2022	Volvo Trucks North America		Valiant TMS	L290 Model Slide Lock Clamp	Drawing name:	= V1UQ52UQ6			
Modification	Date	Name	Original	Replacement of		Replaced by	Scale 1:1	Document type:	MFS	Project nr:	22-16151	Page
								= 2V04&MFS-PNEU				227

A2

=KH0+KH0/1.7 / +V1UQ53KH1-P1

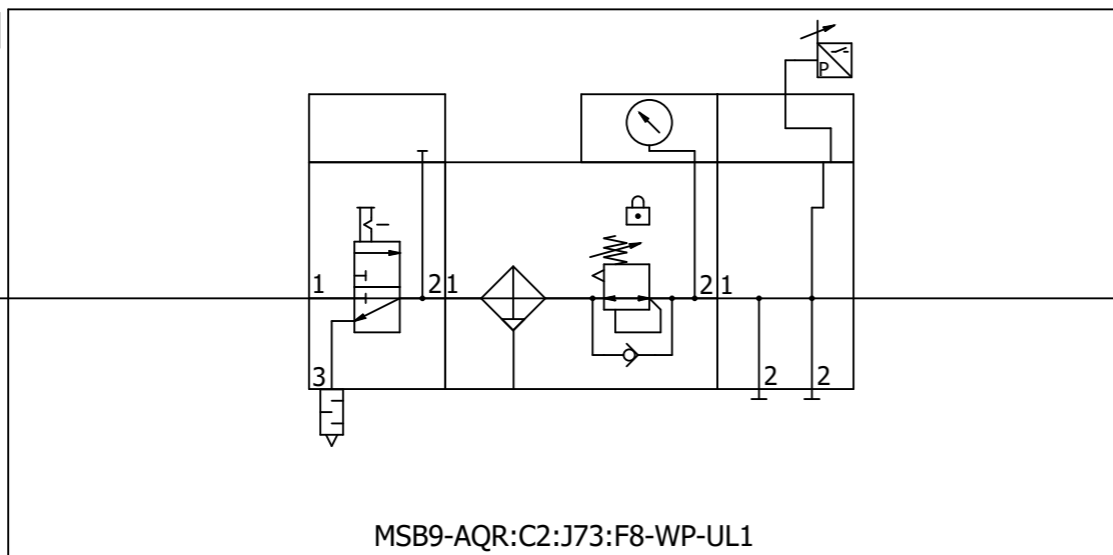

1/2"

+V1UQ53-P1 / =V1UQ53KF1+V1UQ53/11.0

=V1UQ52UQ6+V1UQ52/1

=V1UQ53KF1+V1UQ53/5

		Date	12/21/2022	Volvo Trucks North America			Valiant TMS	Incoming air supply (Fixture)	Drawing name:		= V1UQ53
		Ed.	MKLEPADLO	P6700 Underbody Mainline - Cell 2V04			Scale 1:1		=2V04&MFS-PNEU		+ KH1
Modification	Date	Name	Original	Replacement of	Replaced by			Document type:	Project nr:	Page	1
								MFS	22-16151		227

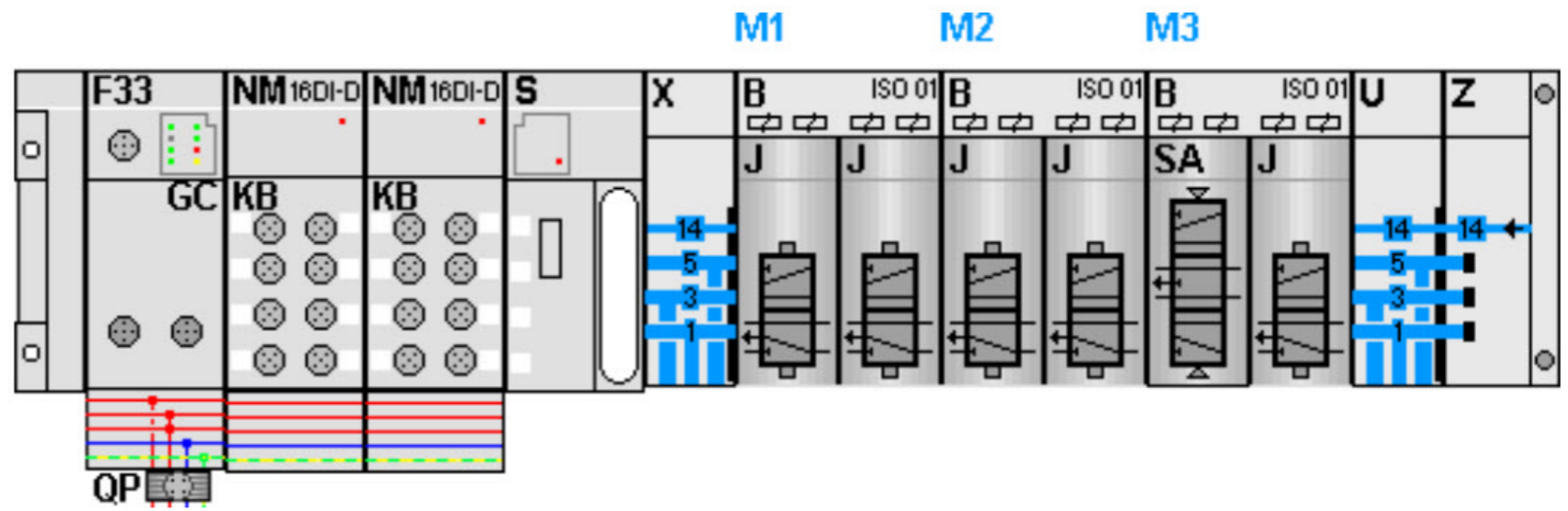

KF1.0

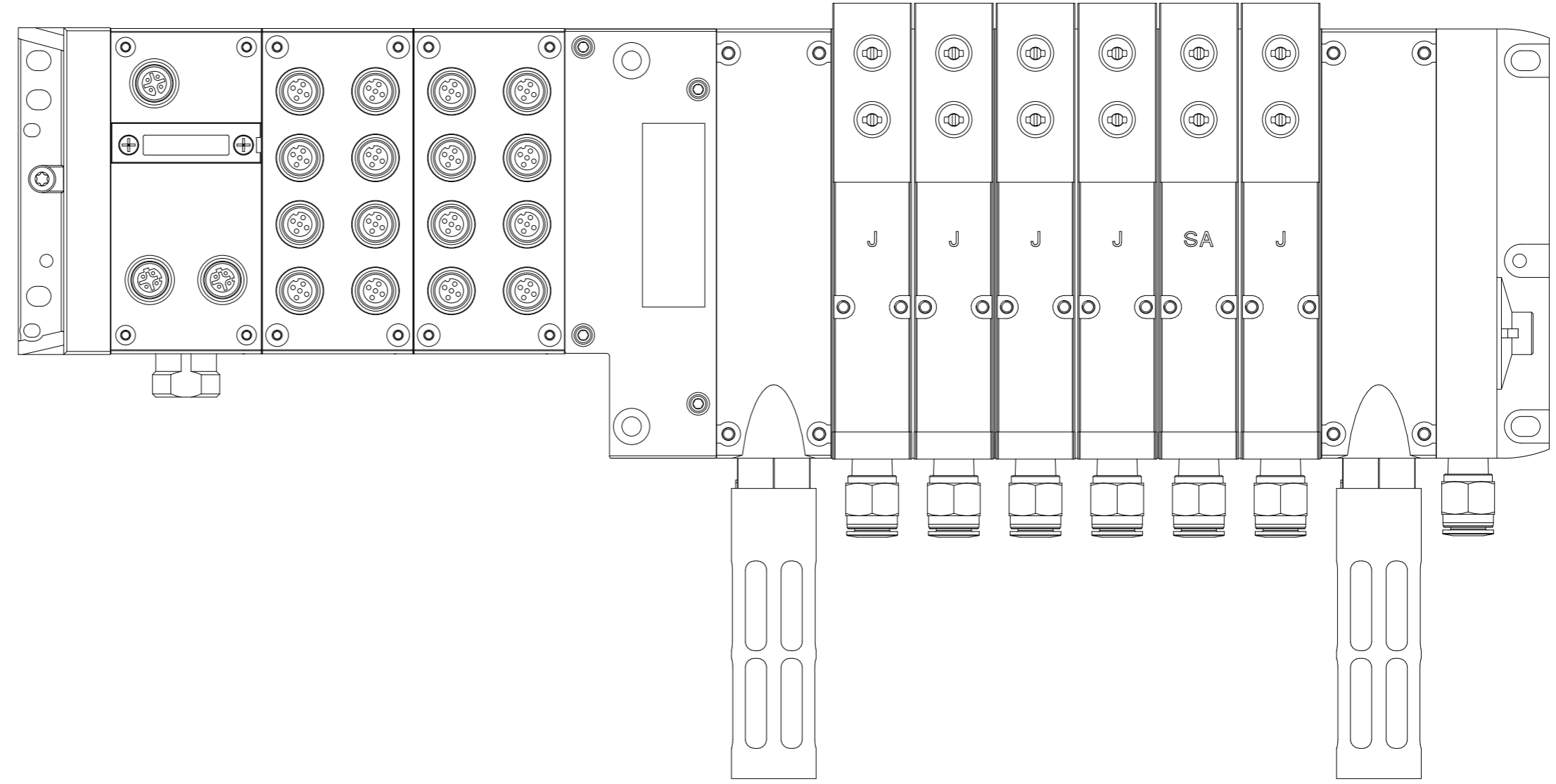

=V1UQ53+KH1/1

Date		12/21/2022		Volvo Trucks North America		Valiant TMS		AIR SUPPLY CONFIGURATION		Drawing name:		= V1UQ53KF1	
Ed.		MKLEPADLO		P6700 Underbody Mainline - Cell 2V04		Scale 1:1				=2V04&MFS-PNEU		+ V1UQ53	
Appr				Replacement of		Replaced by				Document type:		Project nr:	
Original										MFS		22-16151	
Modification		Date		Name								Page	
												5	
												227	



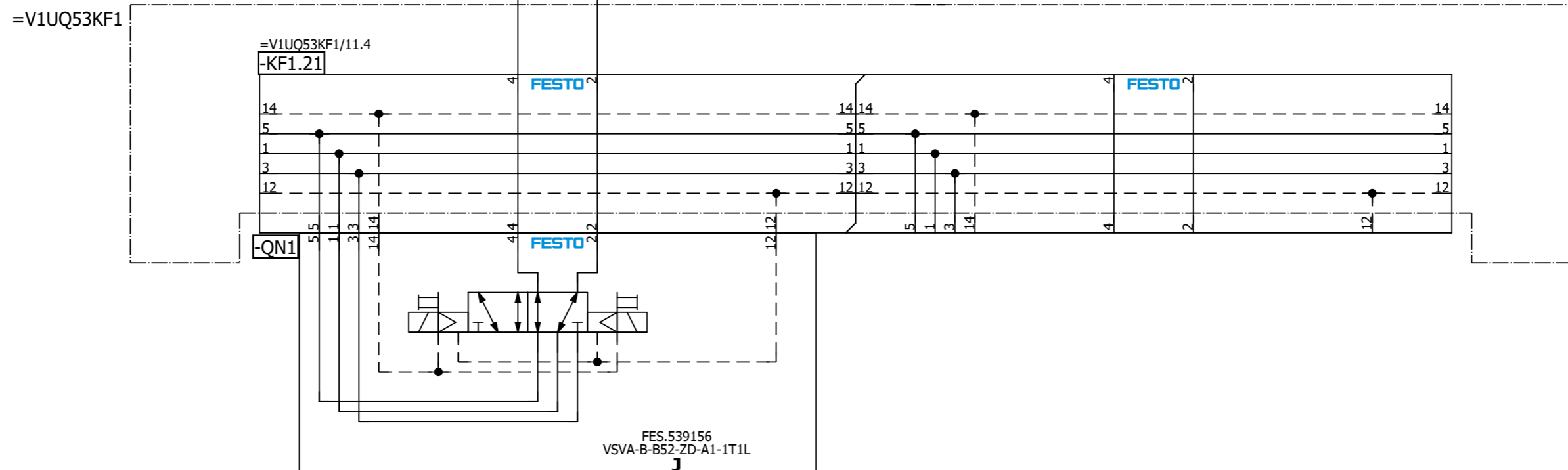
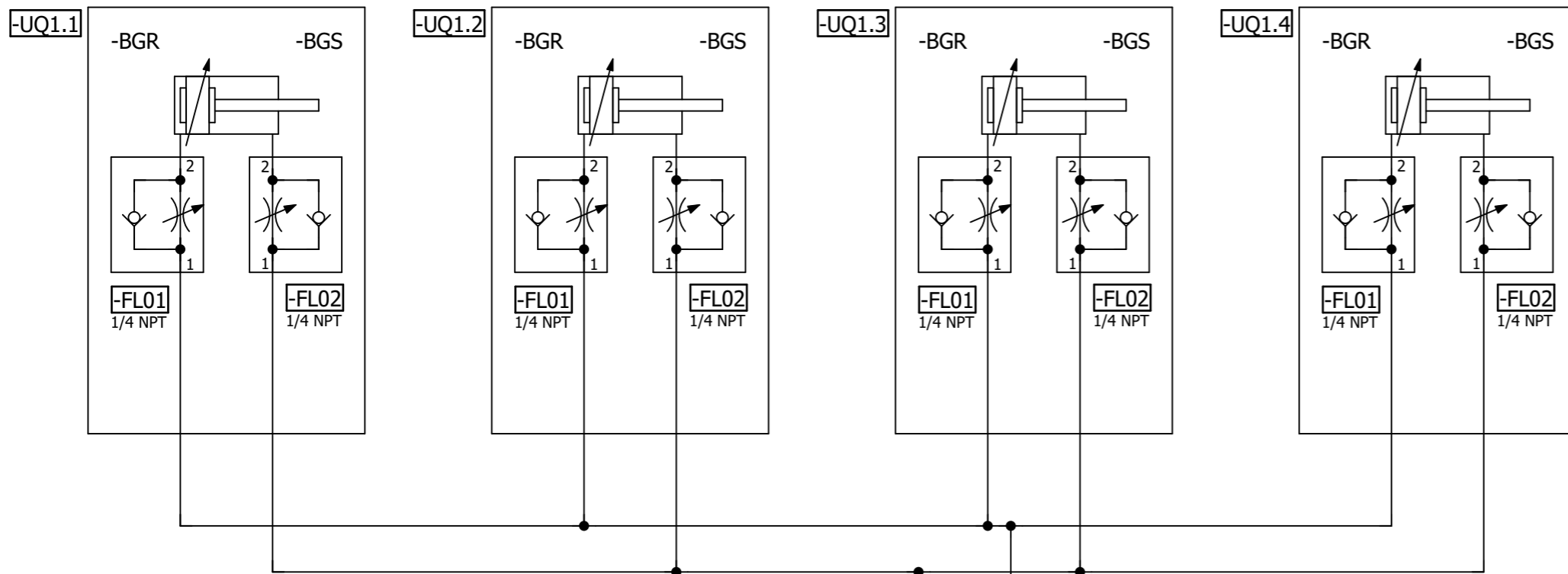

=V1UQ53  
-UQ1-QN1.1  
Common  
Clamps (RST)

=V1UQ53  
-UQ1-QN1.2  
Common  
Clamps (SET)



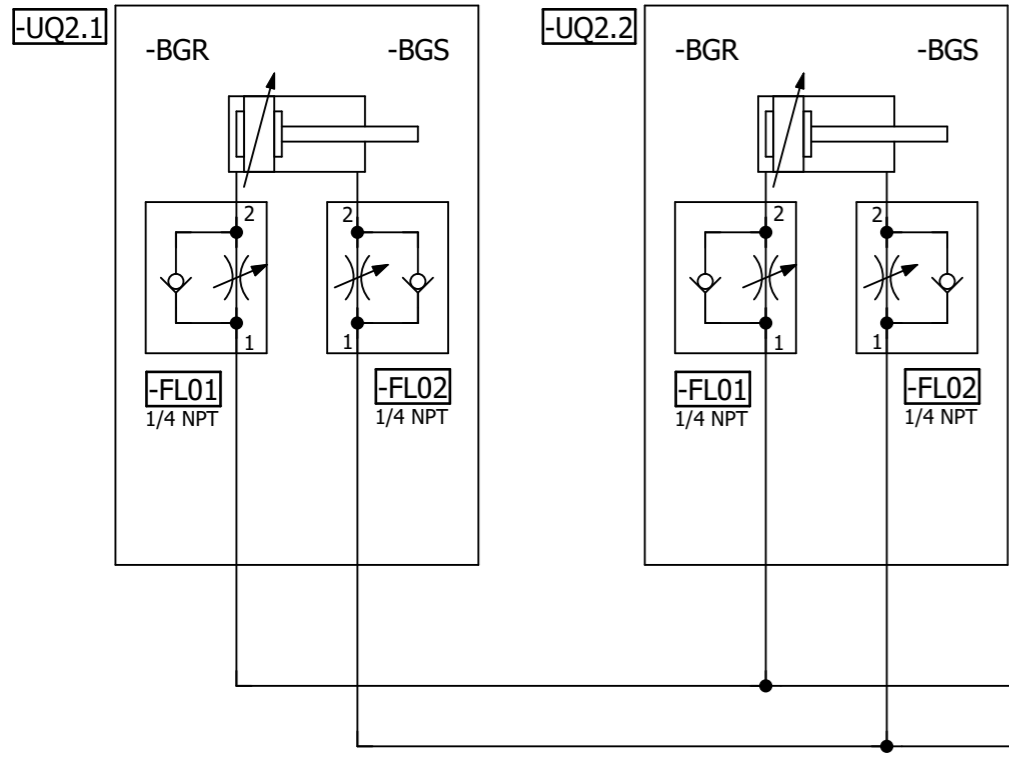

=V1UQ53KF1

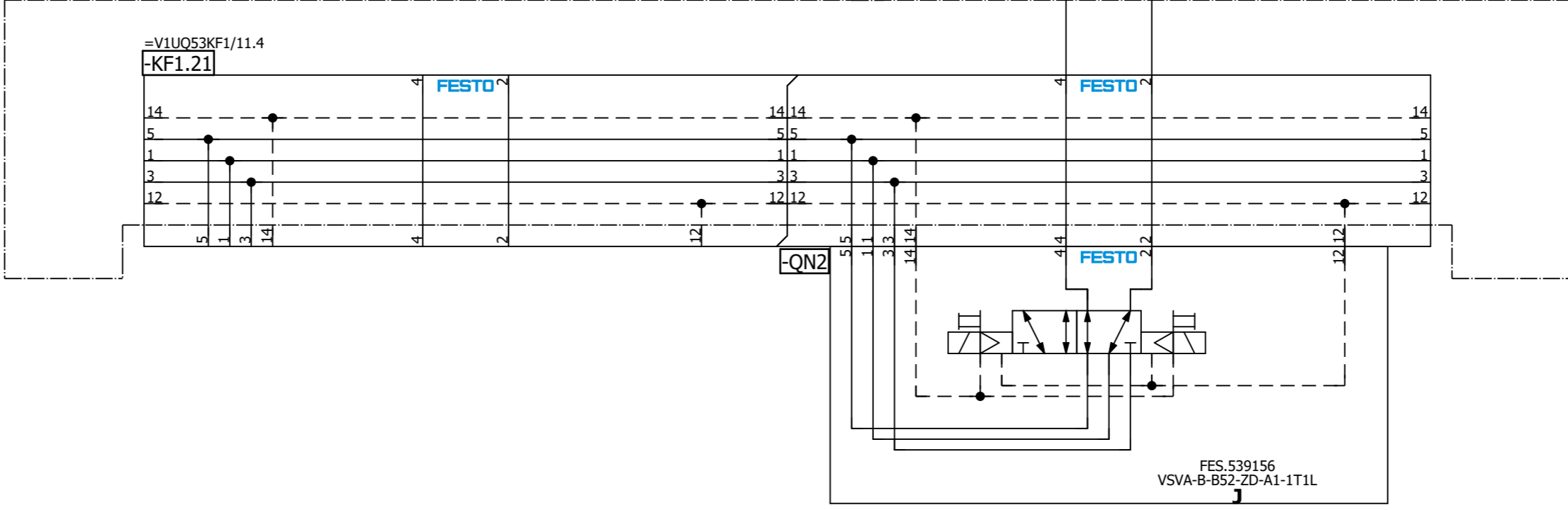

=V1UQ53  
-UQ2-QN2.1  
L150 Model  
Clamps (RST)

=V1UQ53  
-UQ2-QN2.2  
L150 Model  
Clamps (SET)

=V1UQ53UQ1/1

=V1UQ53UQ3/1



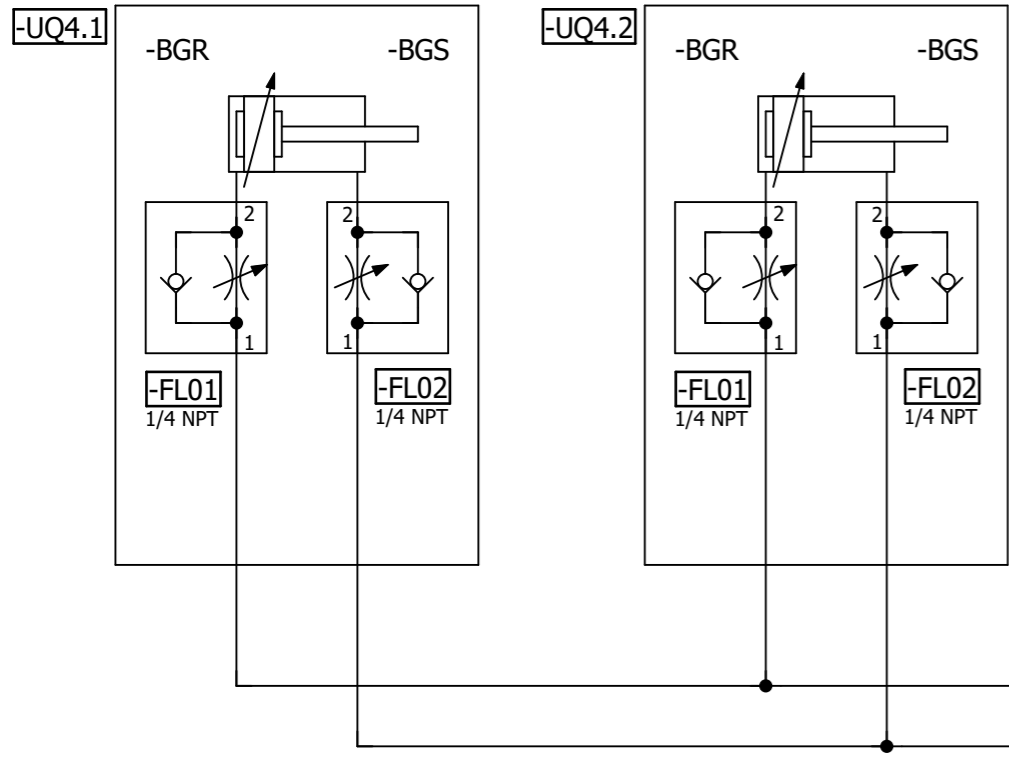

=V1UQ53KF1

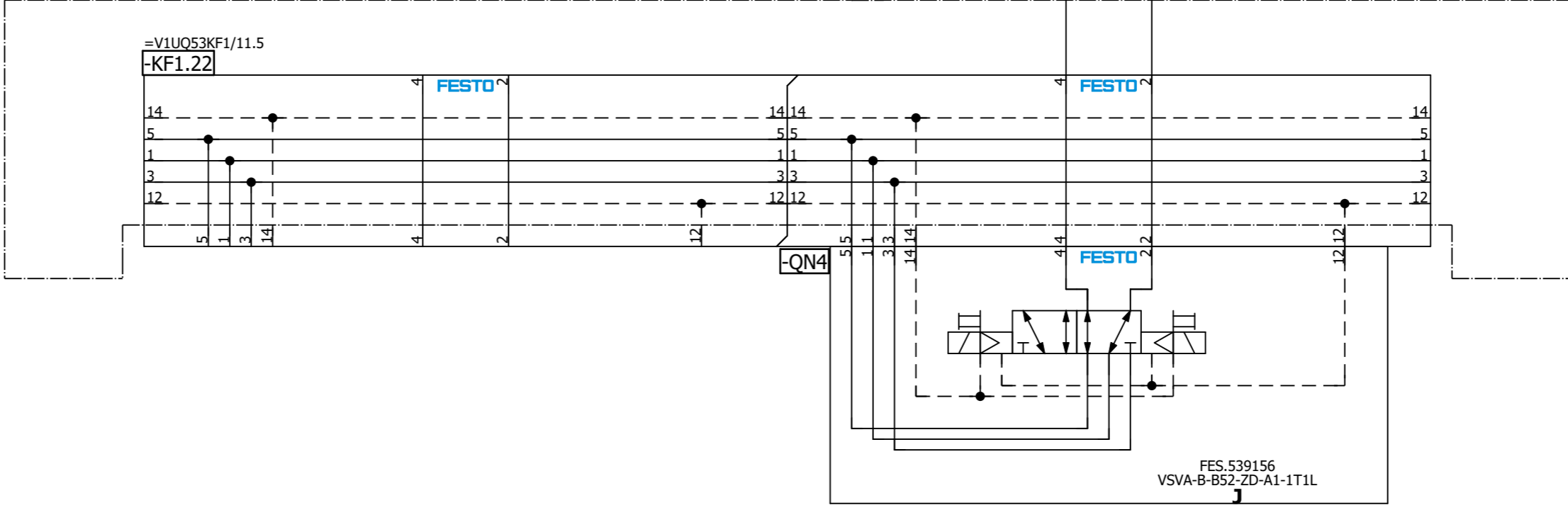

=V1UQ53  
-UQ4-QN4.1  
L230/290/320  
Clamps (RST)

=V1UQ53  
-UQ4-QN4.2  
L230/290/320  
Clamps (SET)

=V1UQ53UQ3/1

=V1UQ53UQ5/1

Date: 12/21/2022		Volvo Trucks North America		Valiant TMS		L230/290/320 Model Clamps		Drawing name: =2V04&MFS-PNEU		= V1UQ53UQ4 + V1UQ53	
Ed.: MKLEPADLO		P6700 Underbody Mainline - Cell 2V04		Scale 1:1				Document type: MFS		Project nr: 22-16151	
Modification	Date	Name	Original	Replacement of	Replaced by					Page	1
											227

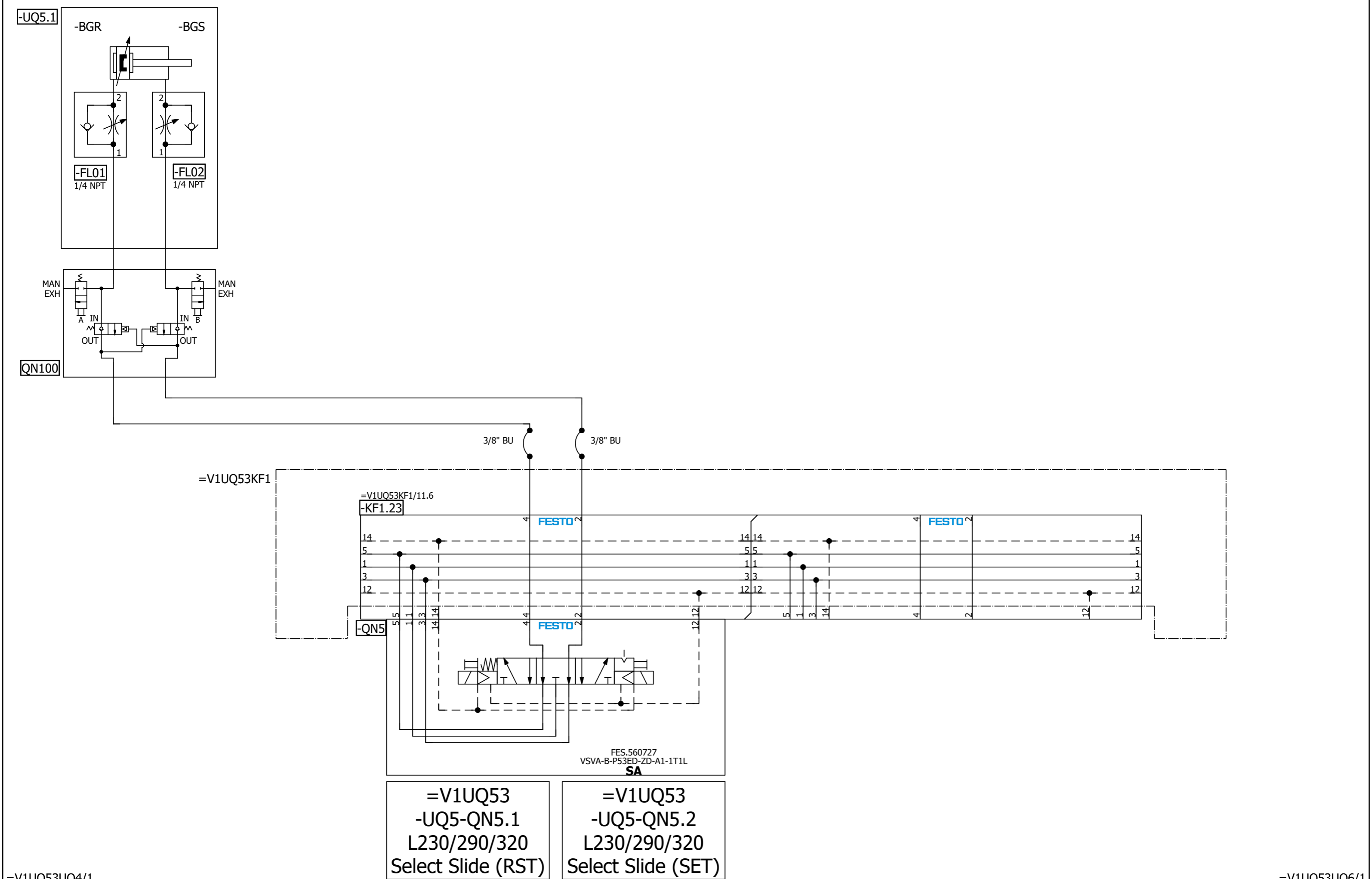

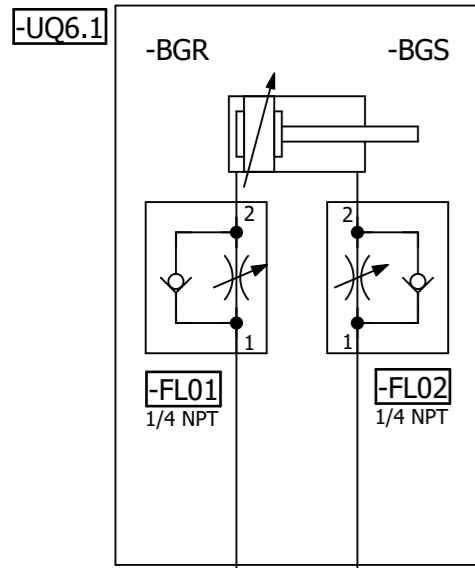

=V1UQ53KF1

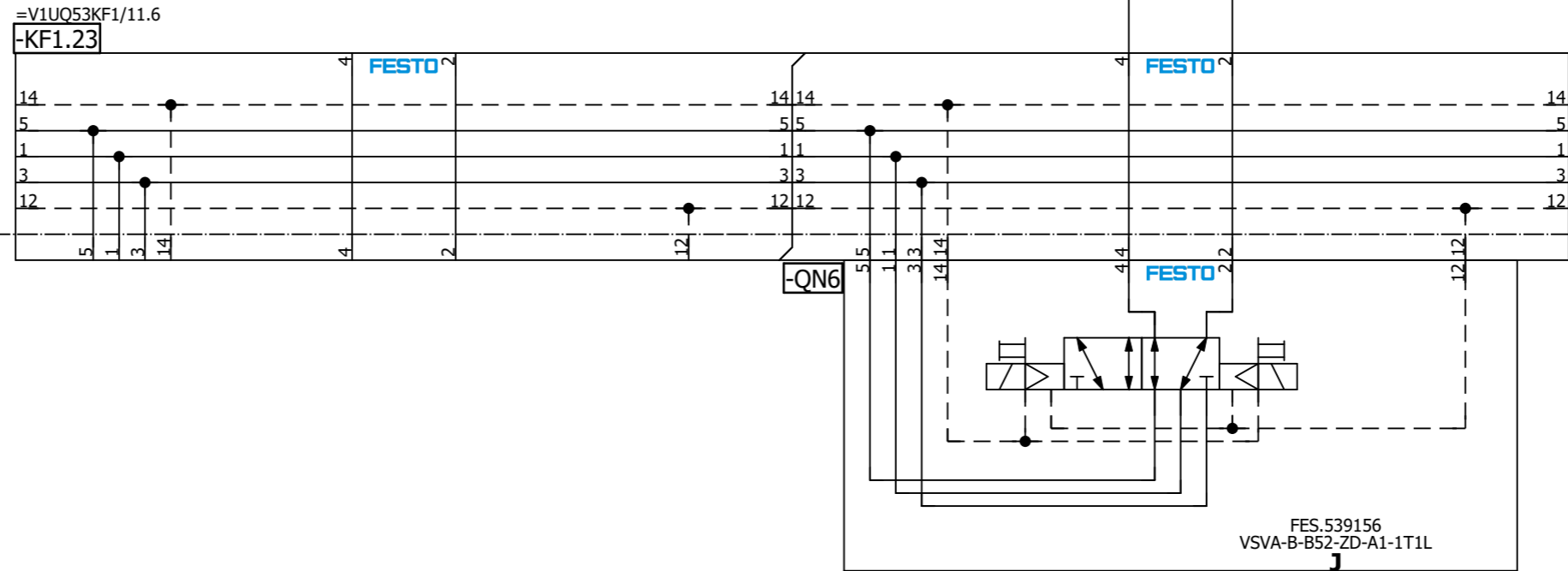

**=V1UQ53  
-UQ6-QN6.1  
L290 Slide Lock  
Clamp (RST)**

**=V1UQ53  
-UQ6-QN6.2  
L290 Slide Lock  
Clamp (SET)**

=V1UQ54+KH1/1

=V1UQ53UQ5/1		Date	12/21/2022	Volvo Trucks North America		Valiant TMS	L290 Model Slide Lock Clamp	Drawing name:	= V1UQ53UQ6	Page 1
		Ed.	MKLEPADLO	P6700 Underbody Mainline - Cell 2V04		Scale 1:1		=2V04&MFS-PNEU	+ V1UQ53	
Modification	Date	Name	Original	Replacement of	Replaced by			Document type:	Project nr:	Page 1
								MFS	22-16151	227

A2

=KH0+KH0/1.7 / +V1UQ54KH1-P1

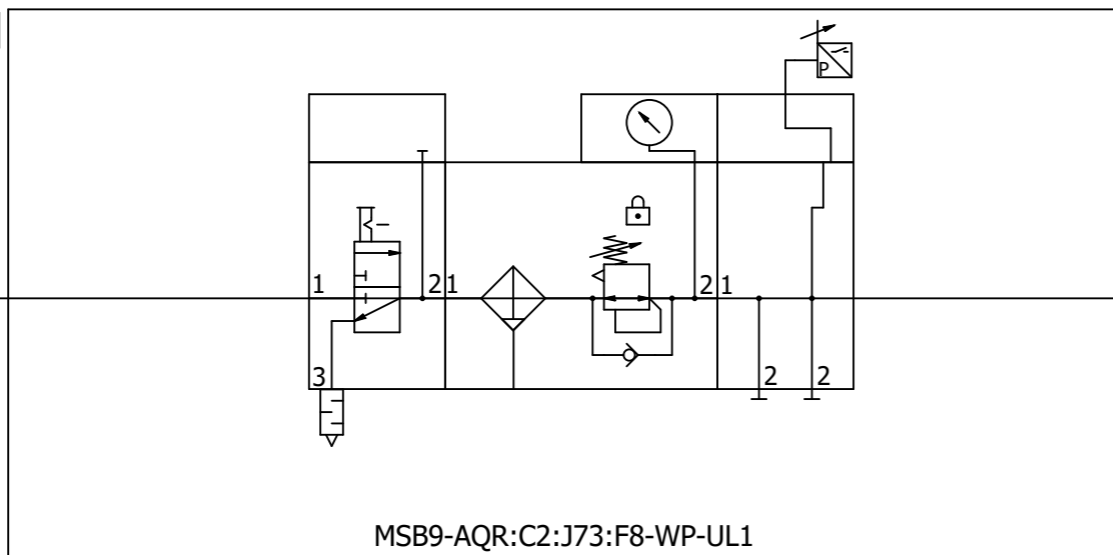

1/2"

+V1UQ54-P1 / =V1UQ54KF1+V1UQ54/11.0

=V1UQ53UQ6+V1UQ53/1

=V1UQ54KF1+V1UQ54/5

		Date	12/21/2022	Volvo Trucks North America			Valiant TMS	Incoming air supply (Fixture)	Drawing name:		= V1UQ54
		Ed.	MKLEPADLO	P6700 Underbody Mainline - Cell 2V04						=2V04&MFS-PNEU	
Modification	Date	Name	Original	Replacement of	Replaced by		Scale 1:1		Document type:	Project nr:	Page
									MFS	22-16151	1
											227



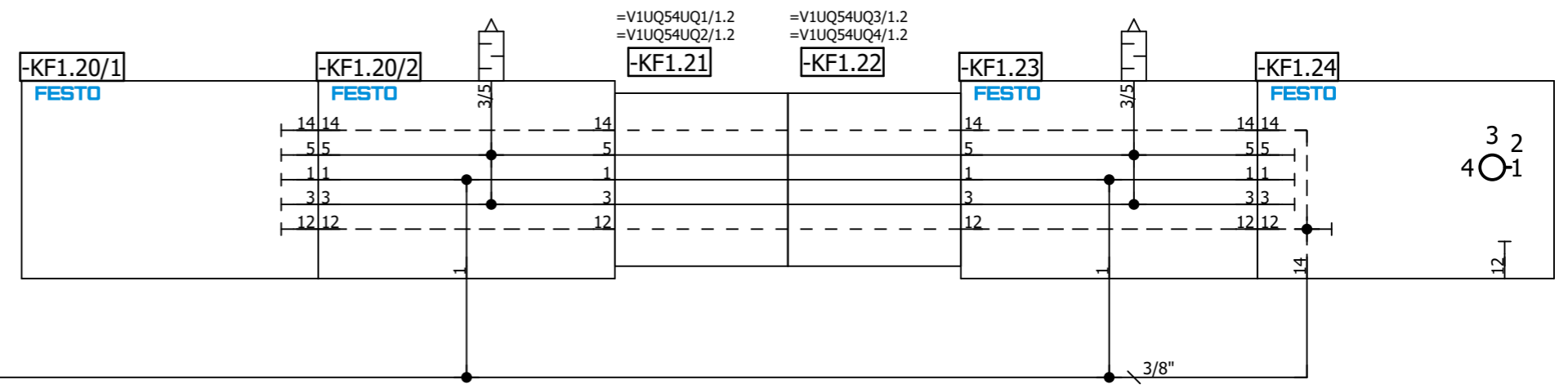
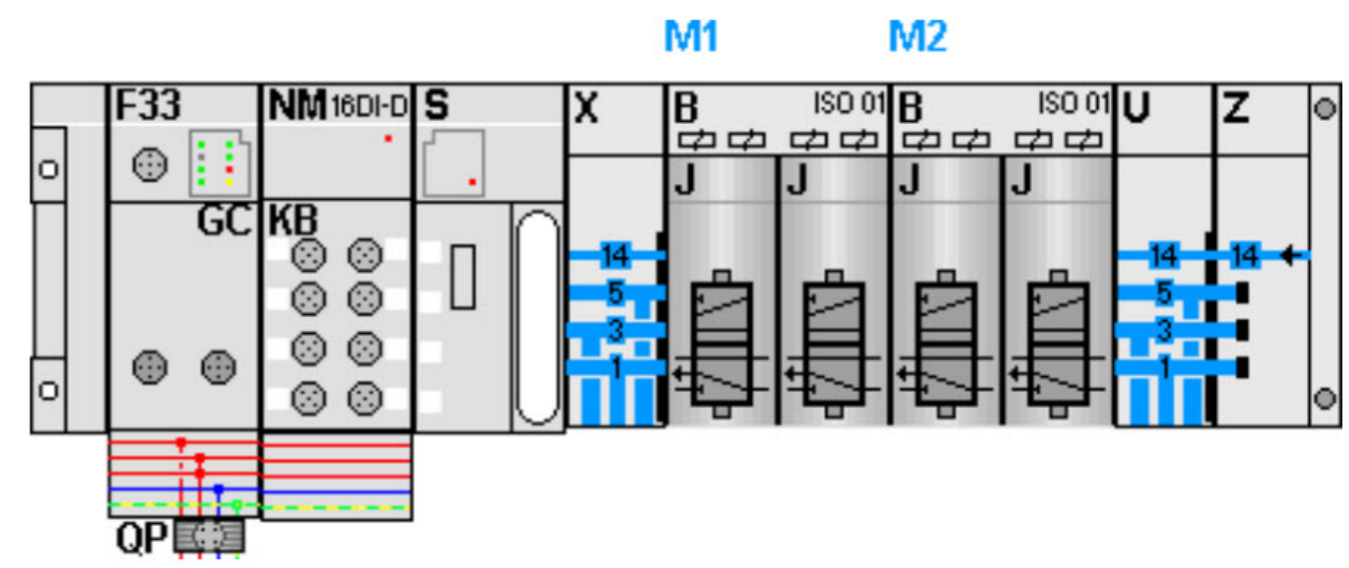

=V1UQ54+KH1/1.6 / P1 → 1/2"

5

=V1UQ54UQ1/1

Date		12/21/2022	Volvo Trucks North America		Valiant TMS	AIR SUPPLY	Drawing name:		= V1UQ54KF1
Ed.		MKLEPADLO	P6700 Underbody Mainline - Cell 2V04				=2V04&MFS-PNEU		+ V1UQ54
Appr.			Replacement of		Scale 1:1	Document type:		MFS	Project nr:
Original			Replaced by			Project nr:		22-16151	Page
									11
									227





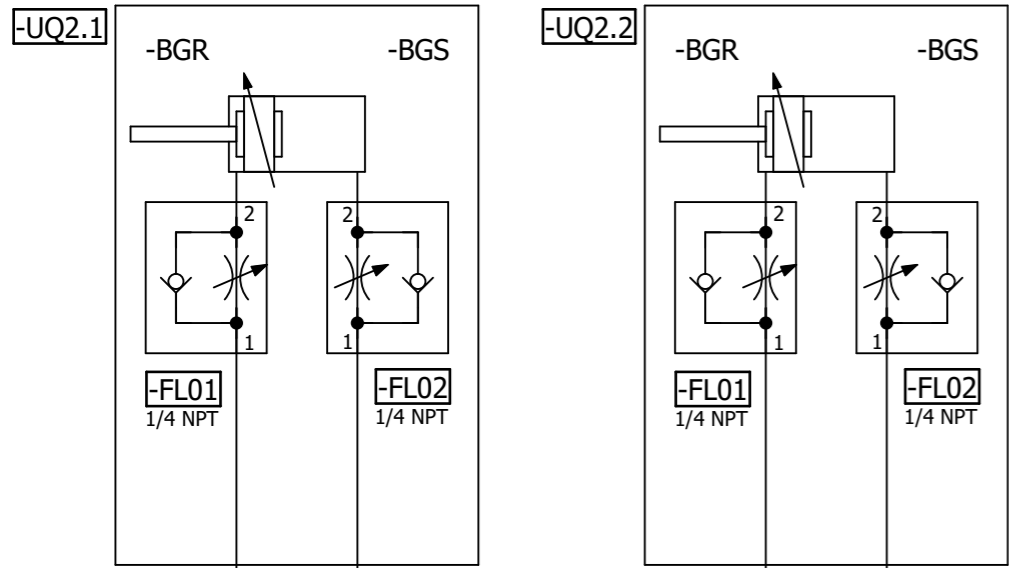

=V1UQ54KF1

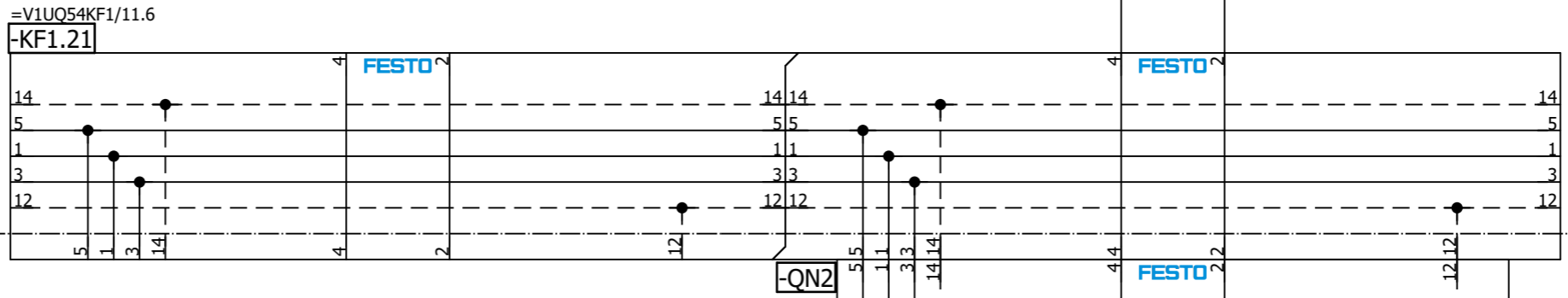

=V1UQ54  
-UQ2-QN2.1  
L230 Model  
Shot Pins (RST)

=V1UQ54  
-UQ2-QN2.2  
L230 Model  
Shot Pins (SET)

FES.539156  
VSVA-B-B52-ZD-A1-1T1L

=V1UQ54UQ1/1

=V1UQ54UQ3/1



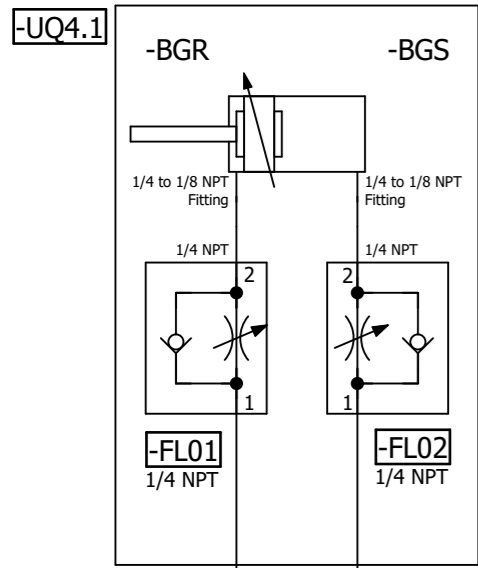

=V1UQ54KF1

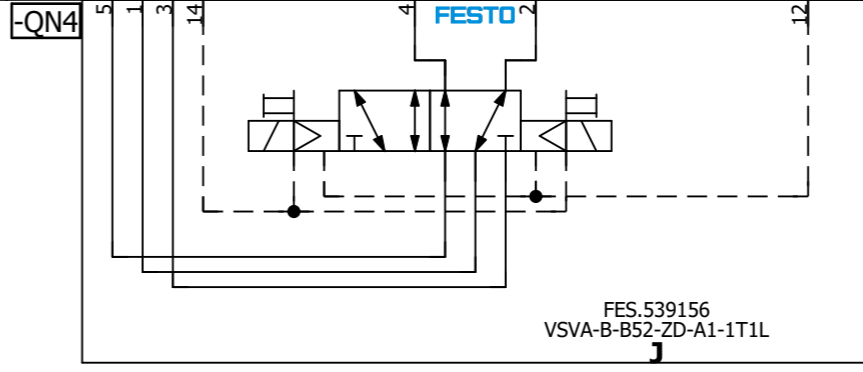
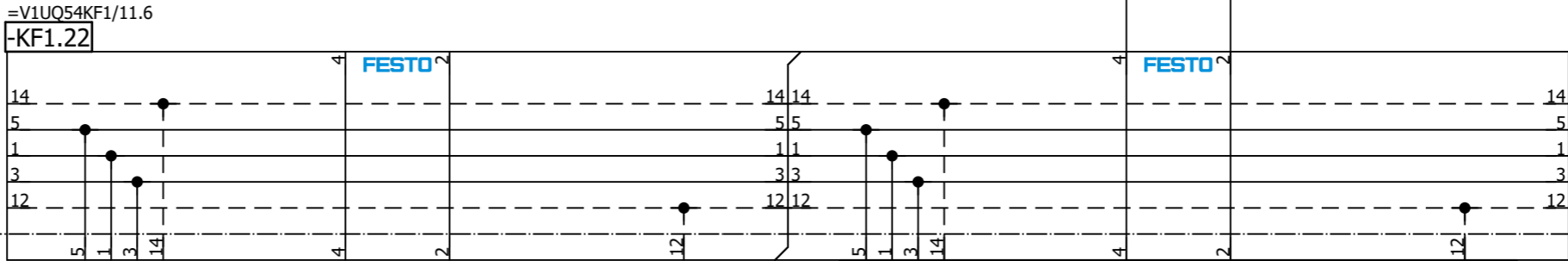

=V1UQ54  
-UQ4-QN4.1  
Common  
Shot Pin (RST)

=V1UQ54  
-UQ4-QN4.2  
Common  
Shot Pin (SET)

=V1UQ55+KH1/1

=V1UQ54UQ3/1		Date	12/21/2022	Volvo Trucks North America	Valiant TMS	Common Shot Pin	Drawing name:		= V1UQ54UQ4
		Ed.	MKLEPADLO				=2V04&MFS-PNEU		+ V1UQ54
		Appr		P6700 Underbody Mainline - Cell 2V04	Scale 1:1		Document type:	Project nr:	Page
Modification	Date	Name	Original	Replacement of			Replaced by	MFS	22-16151
									227

A2

=KH0+KH0/1.7 / +V1UQ55KH1-P1 →

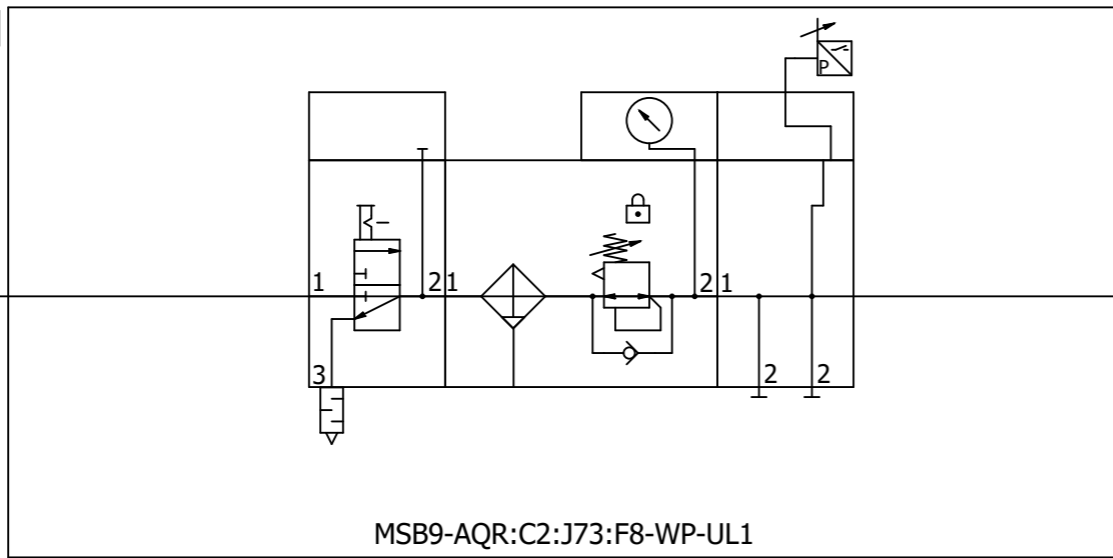

1/2"

→ +V1UQ55-P1 / =V1UQ55KF1+V1UQ55/11.0

MSB9-AQR:C2:J73:F8-WP-UL1

=V1UQ54UQ4+V1UQ54/1

=V1UQ55KF1+V1UQ55/5

		Date	12/21/2022	Volvo Trucks North America			Valiant TMS	Incoming air supply (Fixture)	Drawing name:		= V1UQ55
		Ed.	MKLEPADLO	P6700 Underbody Mainline - Cell 2V04						=2V04&MFS-PNEU	
		Appr.		Replacement of			Scale 1:1	Document type:		Project nr:	Page
Modification	Date	Name	Original	Replaced by				MFS		22-16151	1
											227





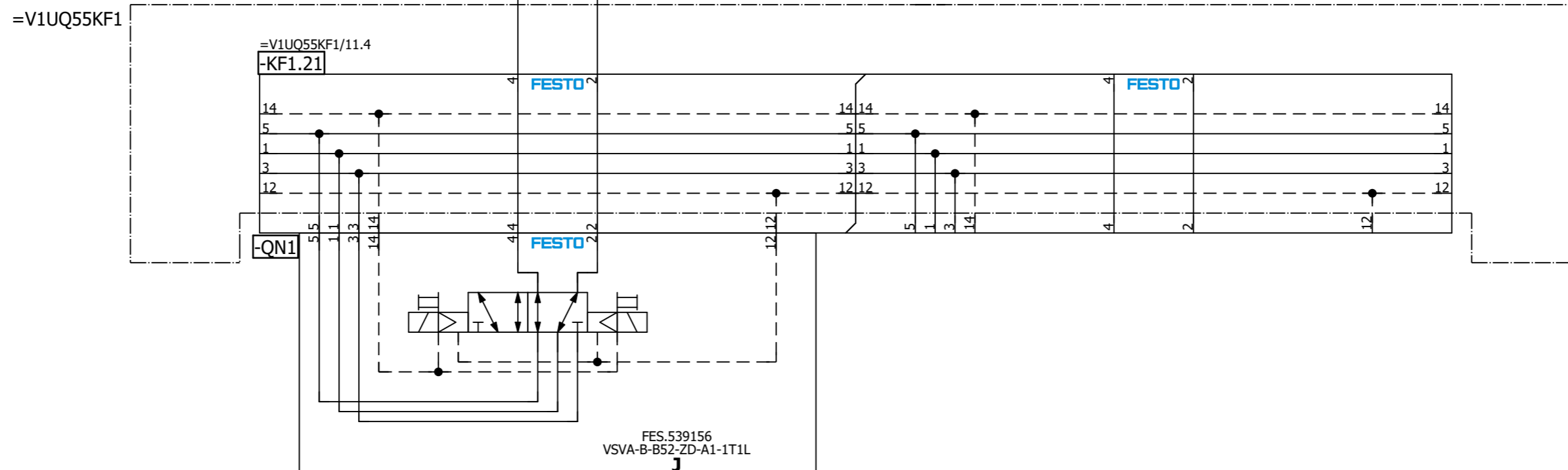
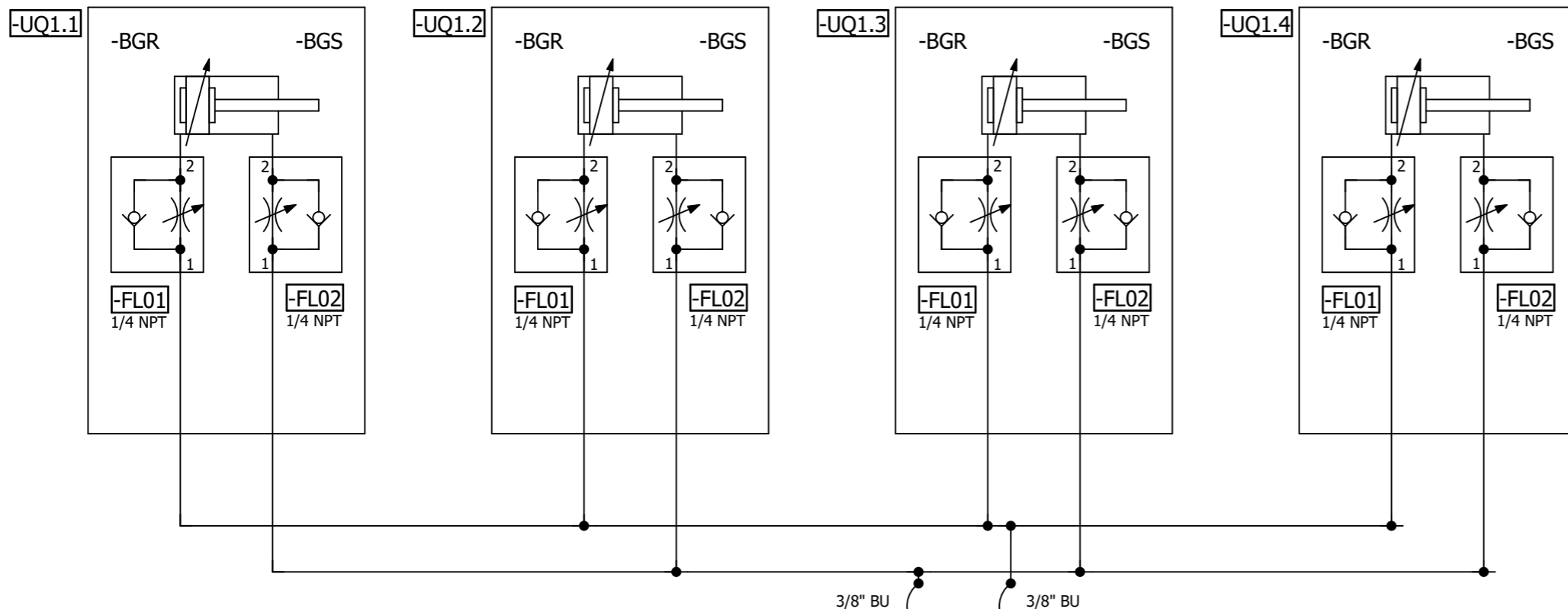

=V1UQ55  
-UQ1-QN1.1  
Common  
Clamps (RST)

=V1UQ55  
-UQ1-QN1.2  
Common  
Clamps (SET)

=V1UQ55KF1/11

=V1UQ55UQ2/1

Date: 12/21/2022		Volvo Trucks North America		Valiant TMS		Drawing name: =2V04&MFS-PNEU		= V1UQ55UQ1	
Ed.: MKLEPADLO		P6700 Underbody Mainline - Cell 2V04		Scale 1:1		Document type: MFS		+ V1UQ55	
Appr.:		Replacement of:		Replaced by:		Project nr: 22-16151		Page 1	
Original:								227	



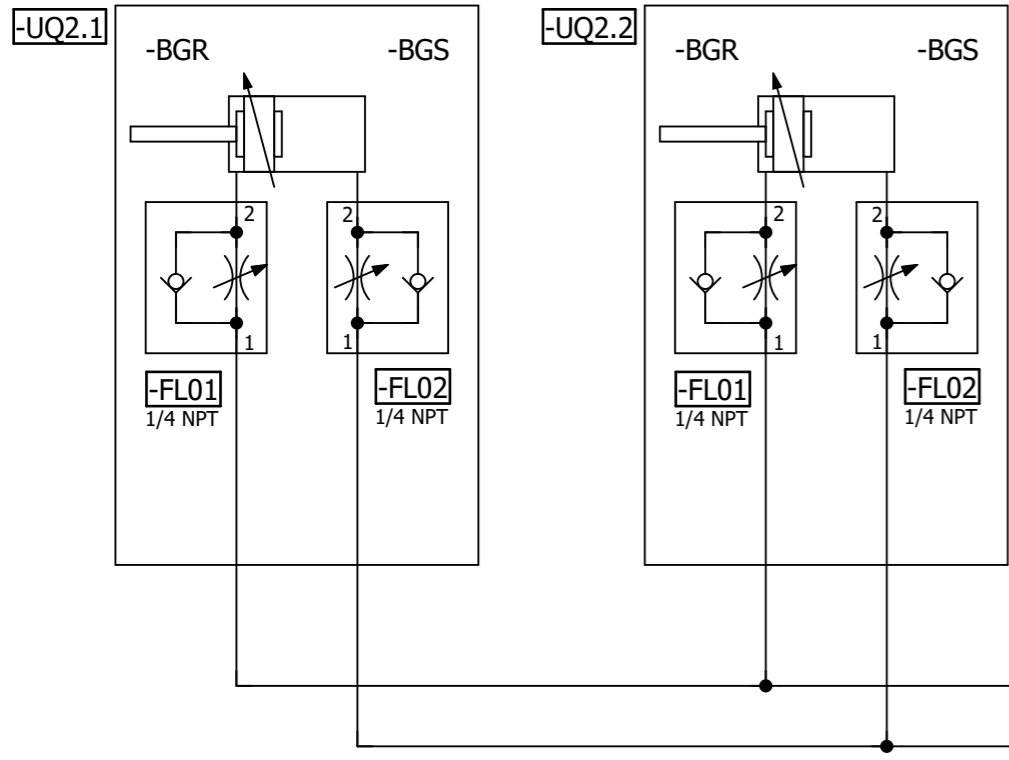

=V1UQ55KF1

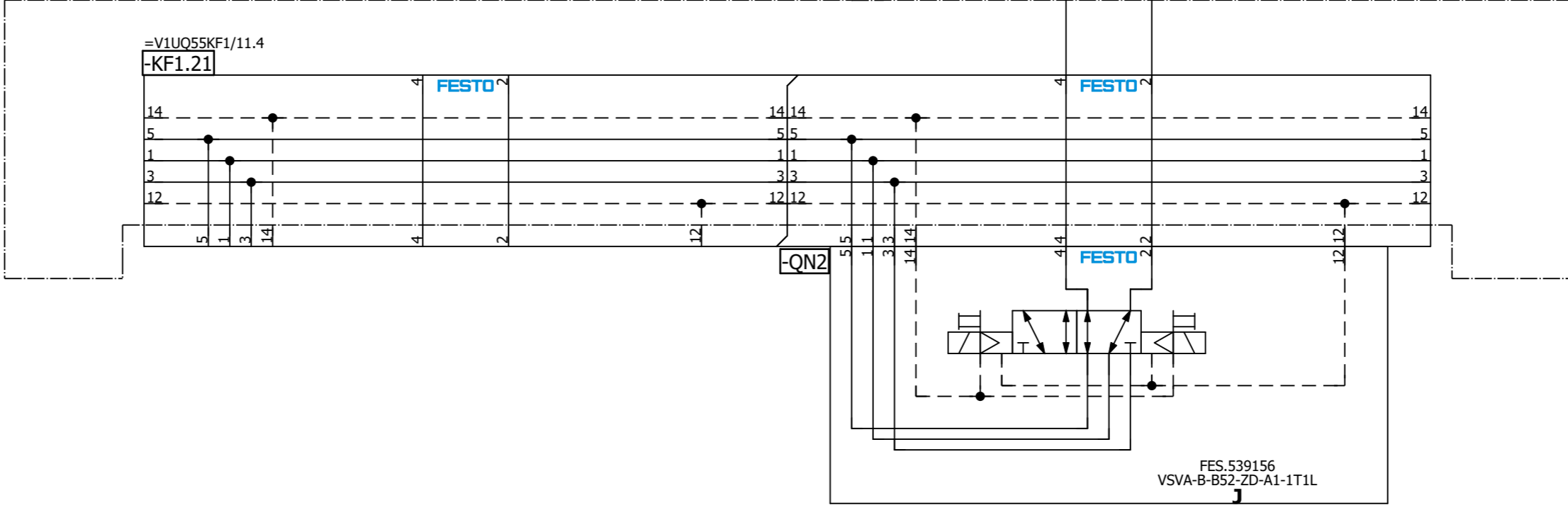

=V1UQ55  
-UQ2-QN2.1  
L150 Model  
Shot Pins (RST)

=V1UQ55  
-UQ2-QN2.2  
L150 Model  
Shot Pins (SET)

=V1UQ55UQ3/1

=V1UQ55UQ1/1			Date	12/21/2022	Volvo Trucks North America	Valiant TMS	L150 Model Shot Pins	Drawing name:	= V1UQ55UQ2	Page	1
			Ed.	MKLEPADLO	P6700 Underbody Mainline - Cell 2V04	Scale 1:1		=2V04&MFS-PNEU		Project nr:	22-16151
			Appr.					Replacement of	Replaced by		
Modification	Date	Name	Original								



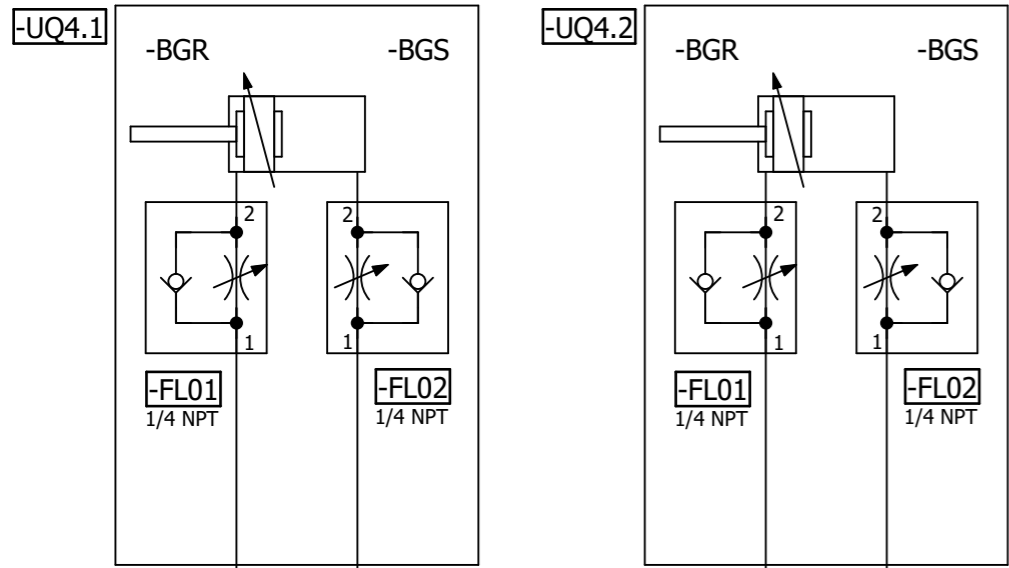

=V1UQ55KF1

=V1UQ55KF1/11.4  
-KF1.22

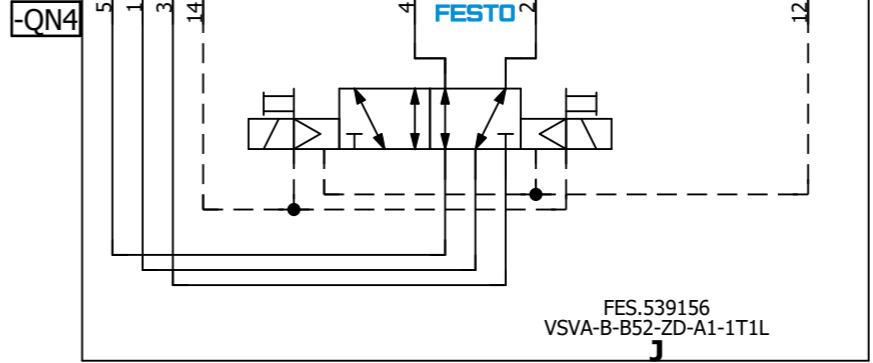

=V1UQ55  
-UQ4-QN4.1  
L230 Model  
Shot Pins (RST)

=V1UQ55  
-UQ4-QN4.2  
L230 Model  
Shot Pins (SET)

=V1UQ55UQ3/1

=V1UQ55UQ5/1

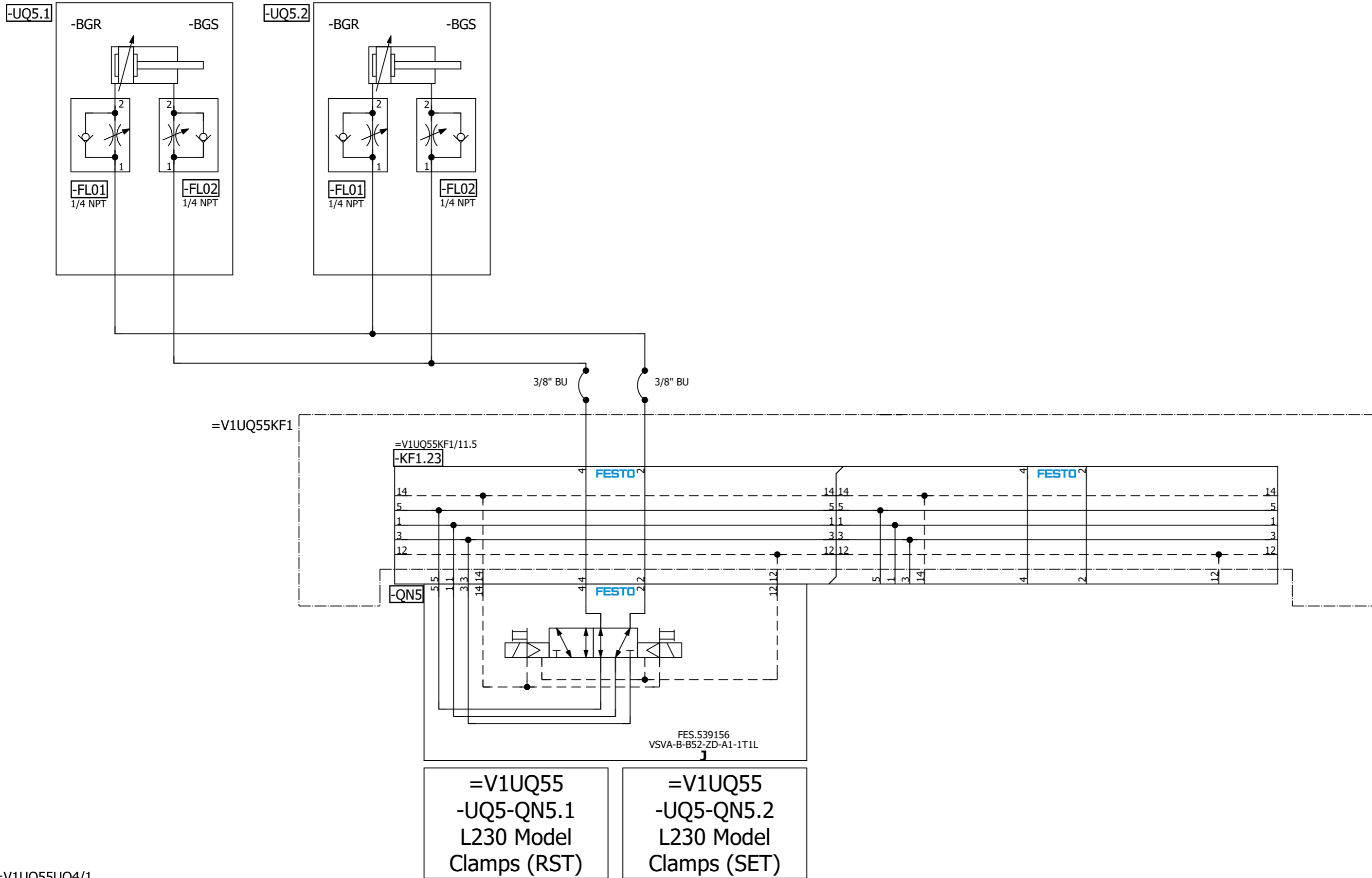

=V1UQ55UQ4/1			=V1UQ55UQ6/1		
Date	12/21/2022	Volvo Trucks North America	Valiant TMS	L230 Model Clamps	Drawing name: =2V04&MFS-PNEU
Ed.	MKLEPADLO	P6700 Underbody Mainline - Cell 2V04	Scale 1:1		= V1UQ55UQ5 + V1UQ55
Appr		Replacement of			Document type: MFS
Original		Replaced by			Project nr: 22-16151
Modification	Date	Name			Page 1 227

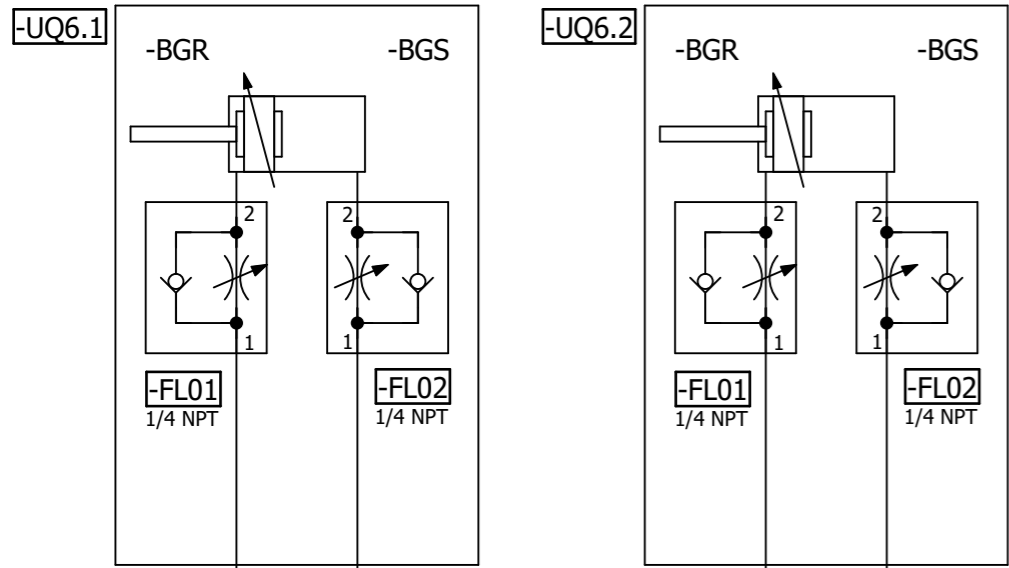

=V1UQ55KF1

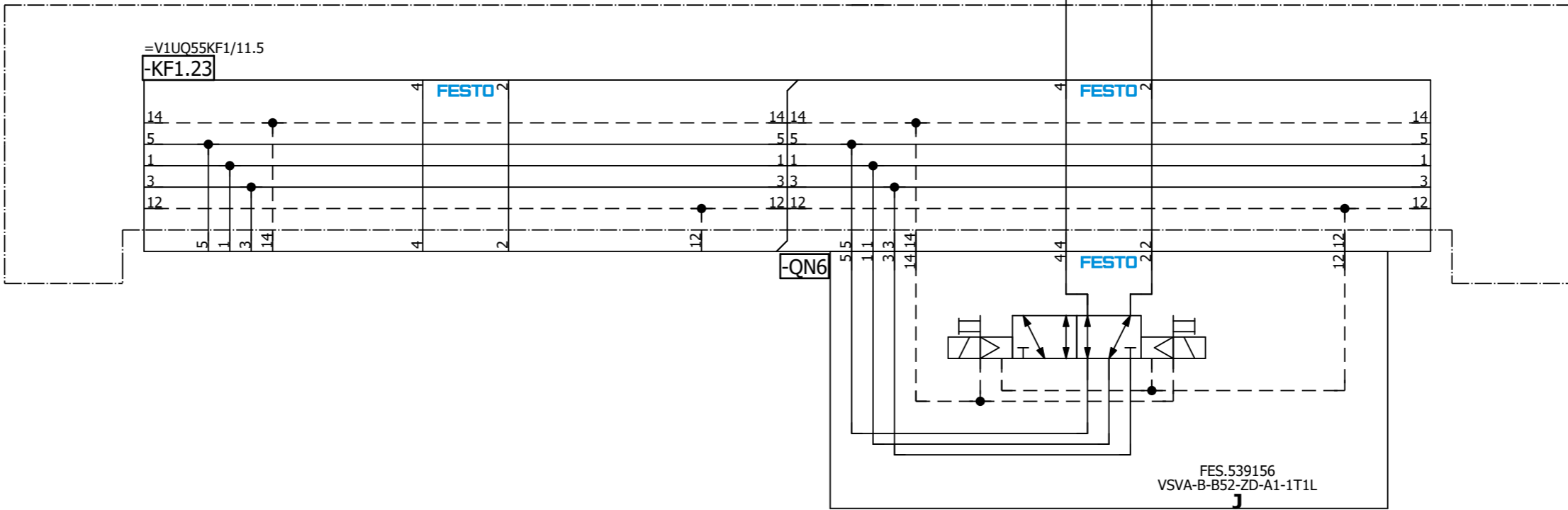

=V1UQ55  
-UQ6-QN6.1  
L290 Model  
Shot Pins (RST)

=V1UQ55  
-UQ6-QN6.2  
L290 Model  
Shot Pins (SET)

=V1UQ55UQ5/1

=V1UQ55UQ7/1

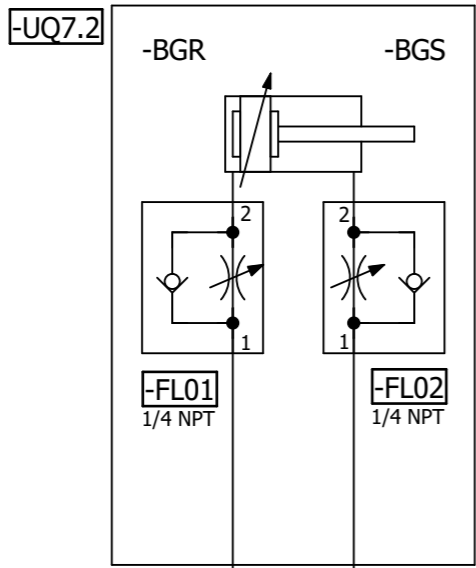
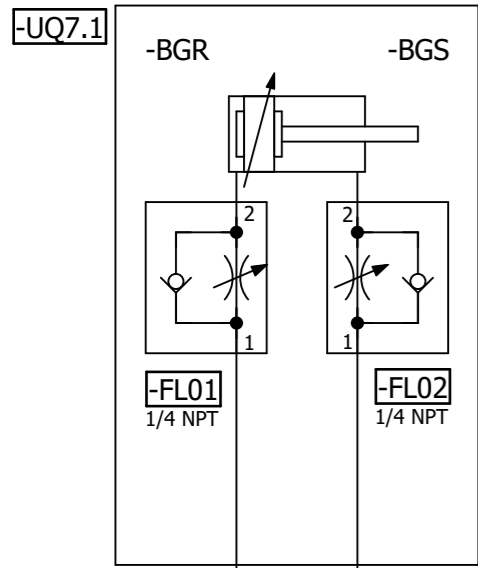

=V1UQ55KF1

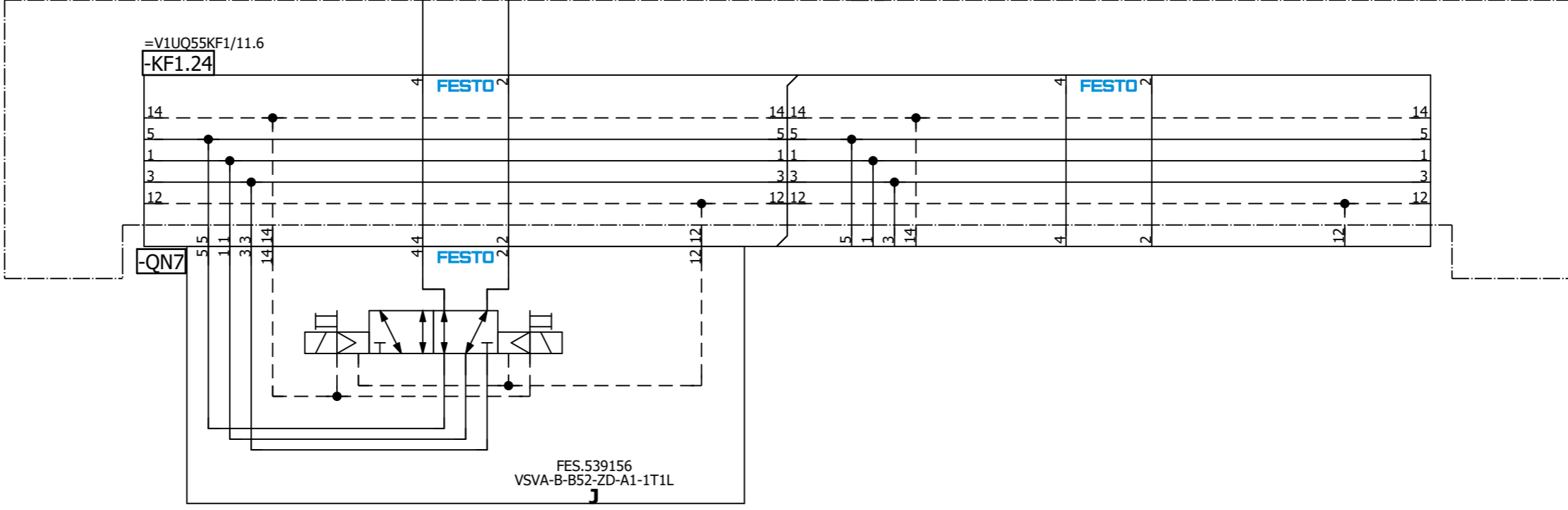

=V1UQ55  
-UQ7-QN7.1  
L290 Model  
Clamps (RST)

=V1UQ55  
-UQ7-QN7.2  
L290 Model  
Clamps (SET)

=V1UQ55UQ6/1

=V1UQ55UQ8/1

Date		12/21/2022	Volvo Trucks North America		Valiant TMS	L290 Model Clamps	Drawing name:		= V1UQ55UQ7	Page	1
Ed.		MKLEPADLO	P6700 Underbody Mainline - Cell 2V04				Document type:		MFS		
Appr			Replacement of		Scale 1:1		Project nr:		22-16151	Page	
Original			Replaced by								227

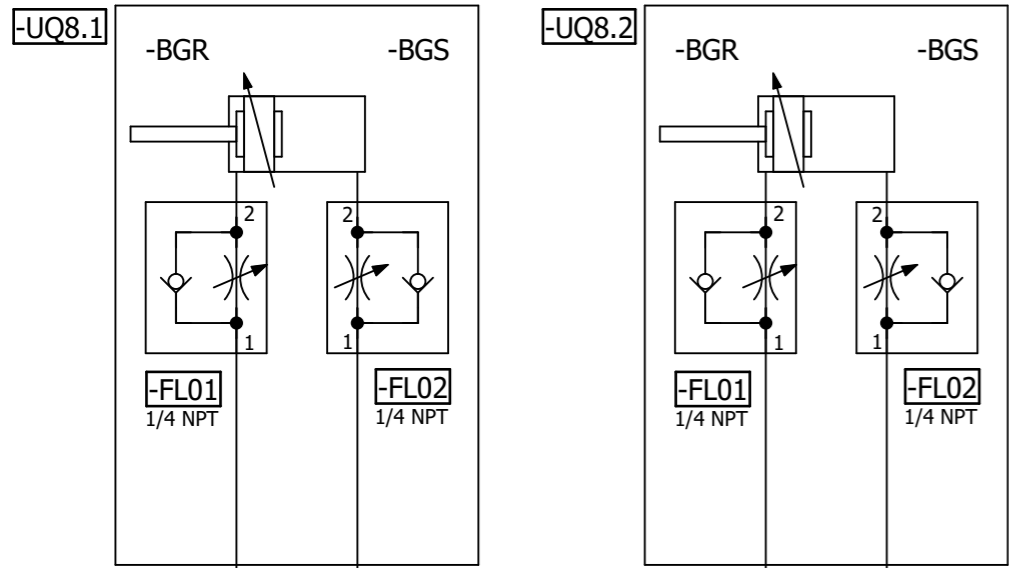

=V1UQ55KF1

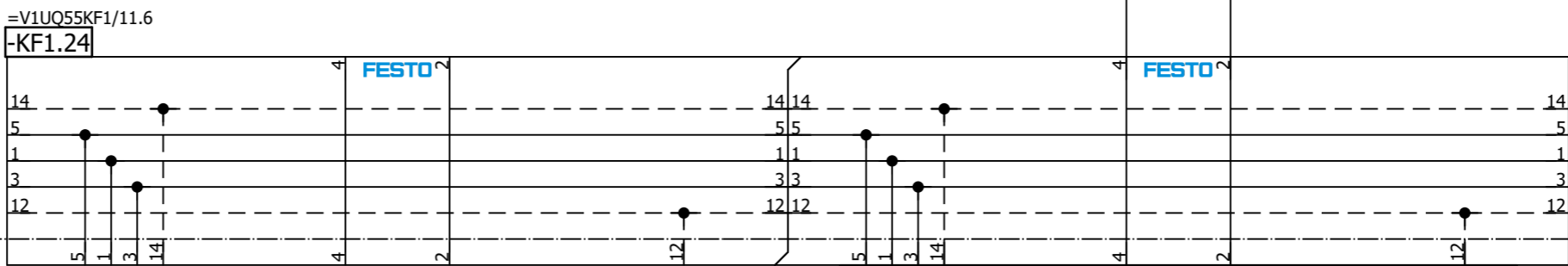

-QN8

FESTO

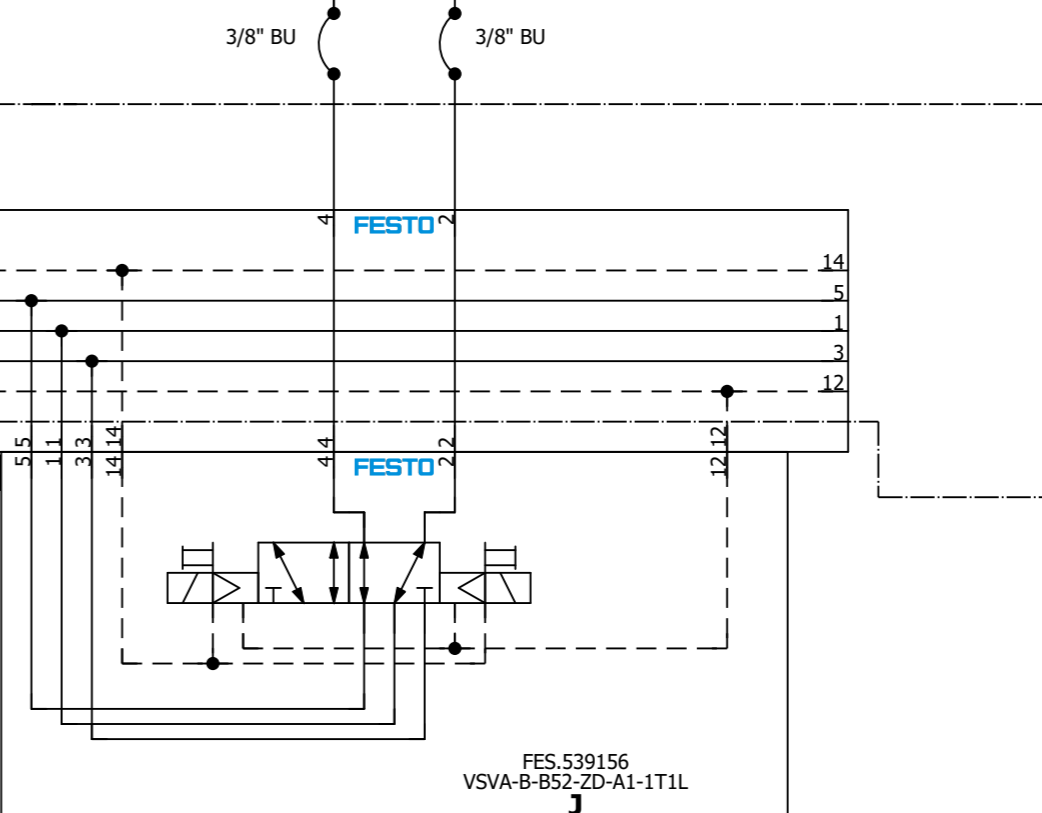

=V1UQ55  
-UQ8-QN8.1  
L320 Model  
Shot Pins (RST)

=V1UQ55  
-UQ8-QN8.2  
L320 Model  
Shot Pins (SET)

=V1UQ55UQ7/1

=V1UQ55UQ9/1

Date		12/21/2022	Volvo Trucks North America		Valiant TMS	L320 Model Shot Pins	Drawing name:		= V1UQ55UQ8
Ed.		MKLEPADLO	P6700 Underbody Mainline - Cell 2V04				=2V04&MFS-PNEU		+ V1UQ55
Appr			Replacement of		Scale 1:1		Document type:		Page
Original			Replaced by				MFS		Project nr:
							22-16151		227







A2

=KH0+KH0/1.7 / +V1WR1KH1-P1

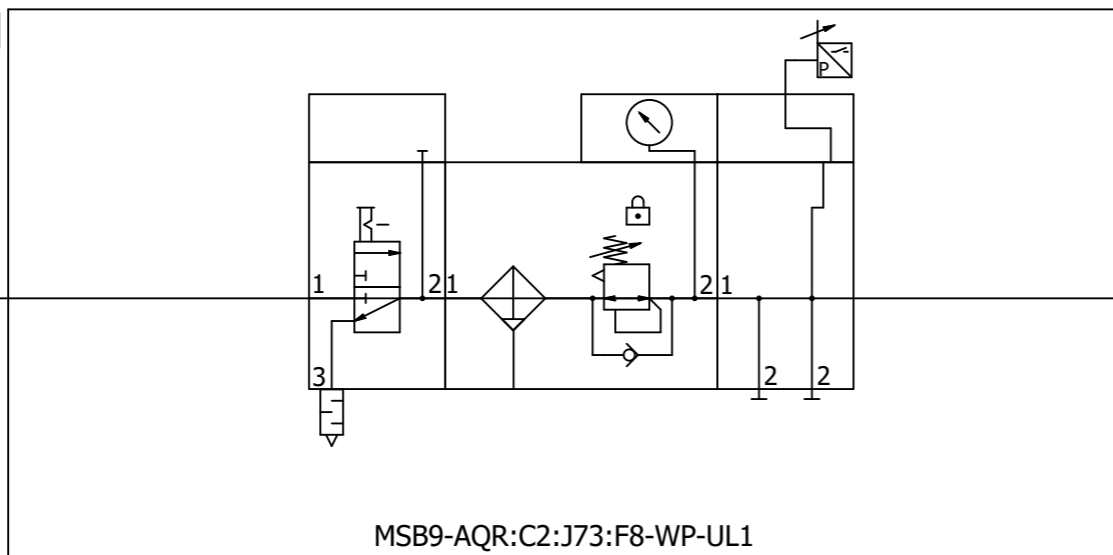

1/2"

+V1WR1UQ51-P1 / =V1WR1UQ51KF1+V1WR1UQ51/11.0

=V1UQ55UQ10+V1UQ55/1

=V1WR1UQ51KF1+V1WR1UQ51/5

		Date	12/21/2022	Volvo Trucks North America			Valiant TMS	Incoming air supply (Trunnion)	Drawing name:		= V1WR1
		Ed.	MKLEPADLO	P6700 Underbody Mainline - Cell 2V04						=2V04&MFS-PNEU	
Modification	Date	Name	Original	Replacement of	Replaced by		Scale 1:1		Document type:	Project nr:	Page
									MFS	22-16151	1
											227

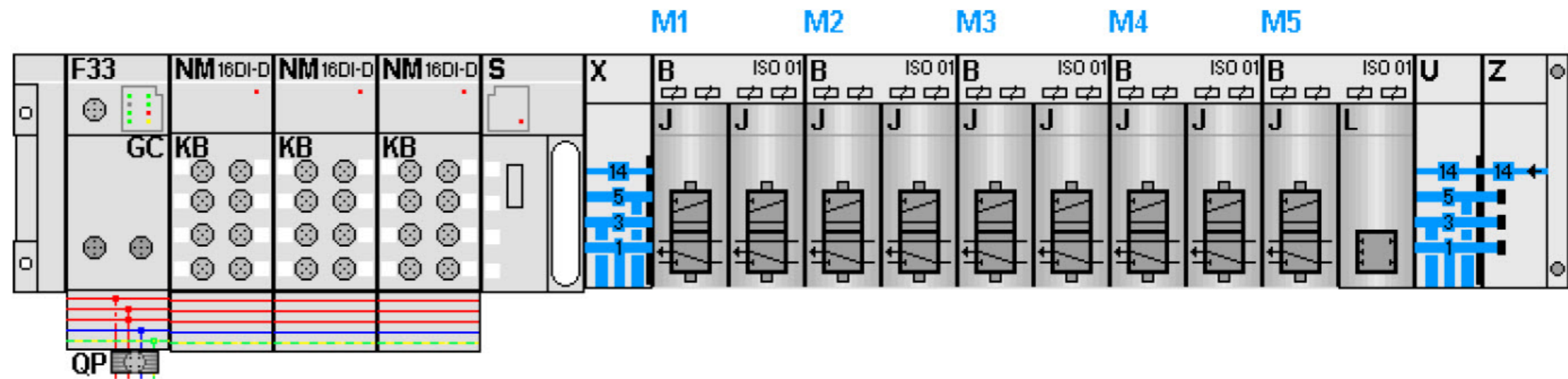

KF1.0

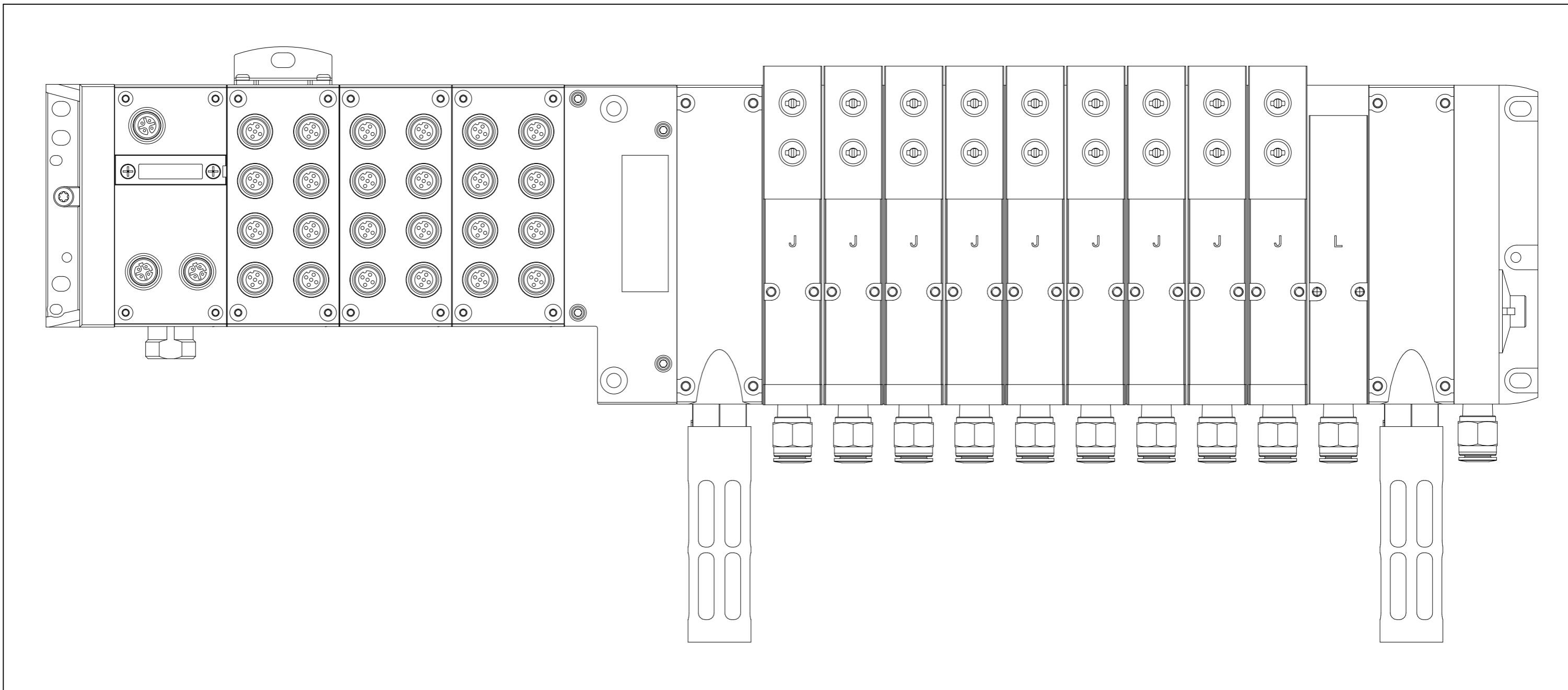

=V1WR1+KH1/1

Date		12/21/2022	Volvo Trucks North America		Valiant TMS	AIR SUPPLY CONFIGURATION	Drawing name:		= V1WR1UQ51KF1	Page	5
Ed.		MKLEPADLO	P6700 Underbody Mainline - Cell 2V04				=2V04&MFS-PNEU		+ V1WR1UQ51		
Appr			Replacement of		Scale 1:1		Document type:		Project nr:	Page	5
Original			Replaced by				MFS				

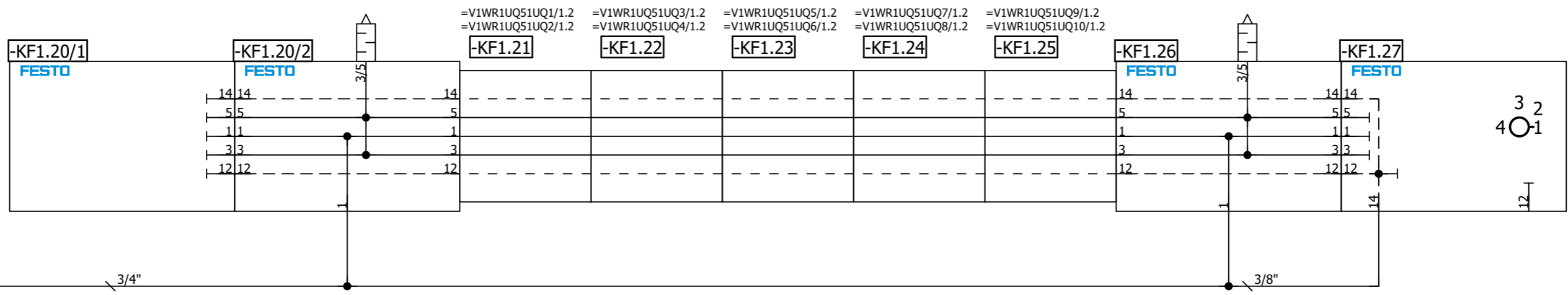
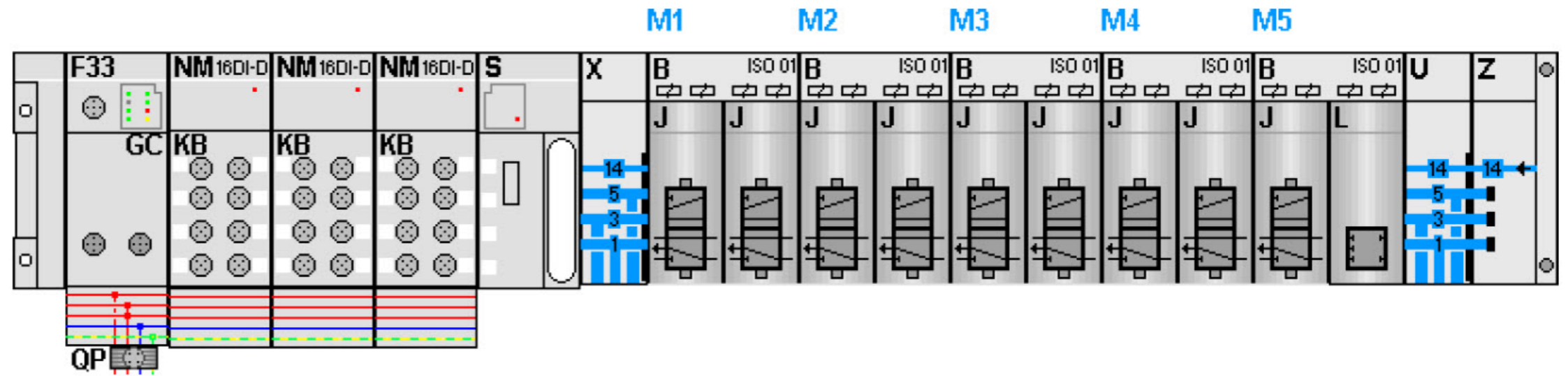

5

Date		12/21/2022	Volvo Trucks North America		Valiant TMS	AIR SUPPLY	Drawing name:		= V1WR1UQ51KF1	
Ed.		MKLEPADLO	P6700 Underbody Mainline - Cell 2V04				=2V04&MFS-PNEU		+ V1WR1UQ51	
Appr.			Replacement of		Scale 1:1	Document type:		Project nr:		Page
Original			Replaced by			MFS		22-16151		11
Modification	Date	Name	Original							227

=V1WR1UQ51UQ1/1



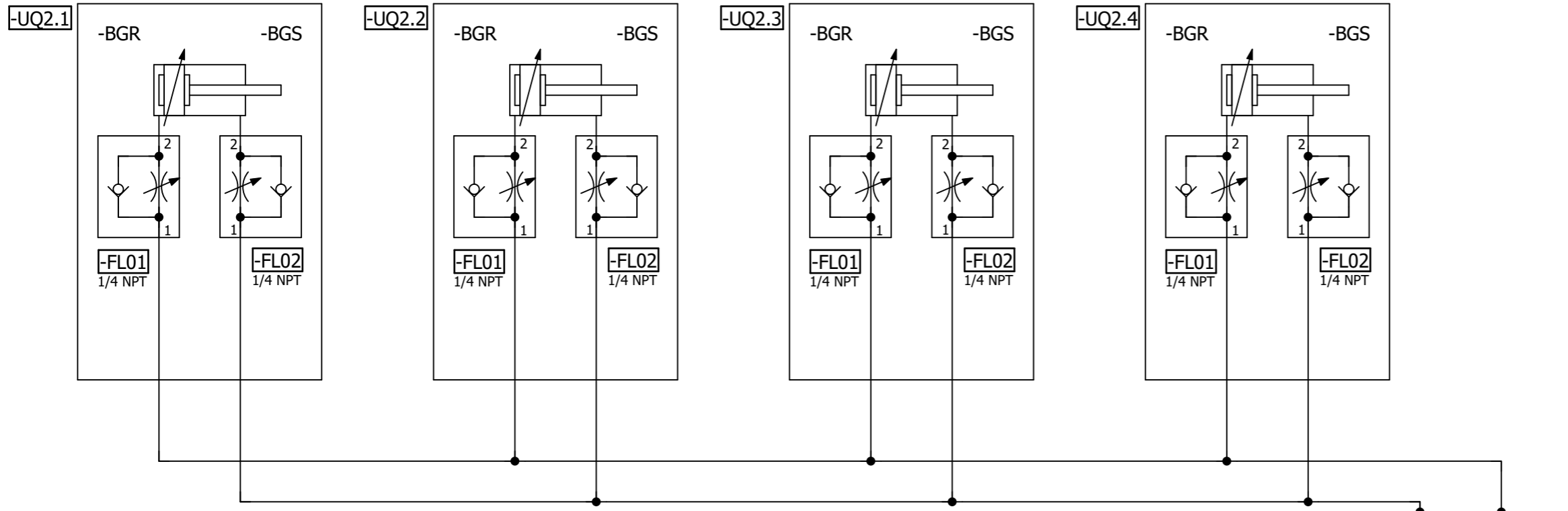

=V1WR1UQ51KF1

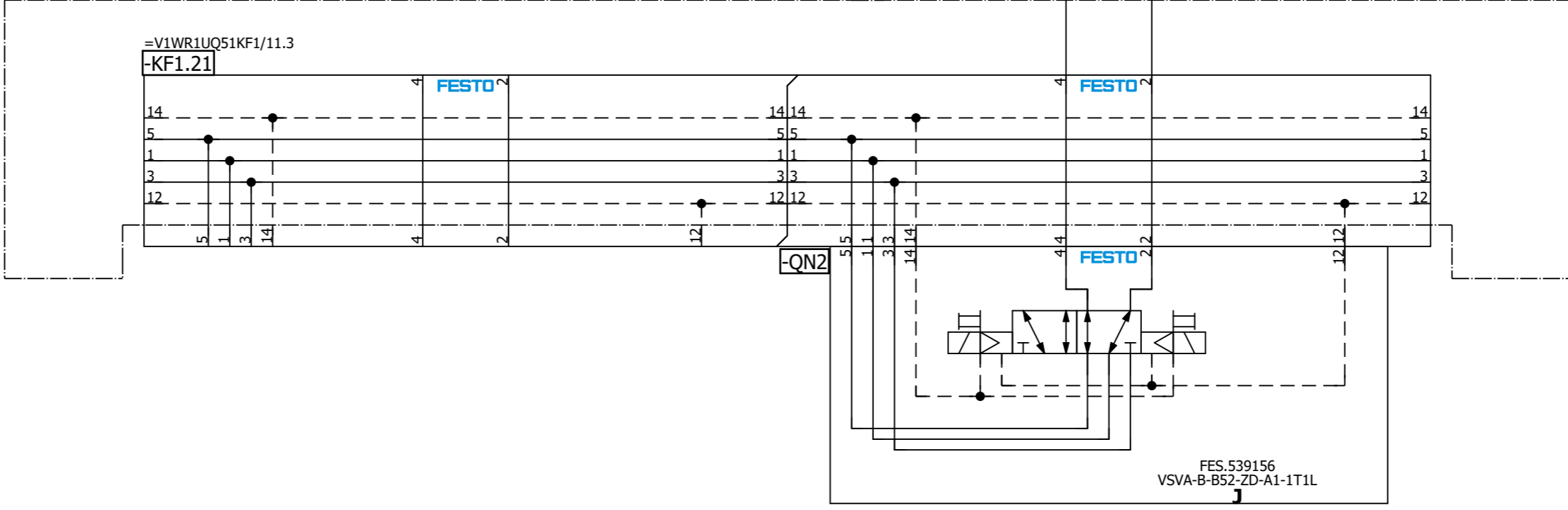

=V1WR1UQ51  
-UQ2-QN2.1  
Common  
Clamps (RST)

=V1WR1UQ51  
-UQ2-QN2.2  
Common  
Clamps (SET)

=V1WR1UQ51UQ3/1

=V1WR1UQ51UQ1/1			Date	12/21/2022	Volvo Trucks North America	Valiant TMS	Common Clamps	Drawing name:	= V1WR1UQ51UQ2	
			Ed.	MKLEPADLO	P6700 Underbody Mainline - Cell 2V04	Scale 1:1		Drawing type:	= 2V04&MFS-PNEU	
			Appr.					Replacement of	Replaced by	Document type:
Modification	Date	Name	Original					Project nr:	22-16151	
									Page	1
										227



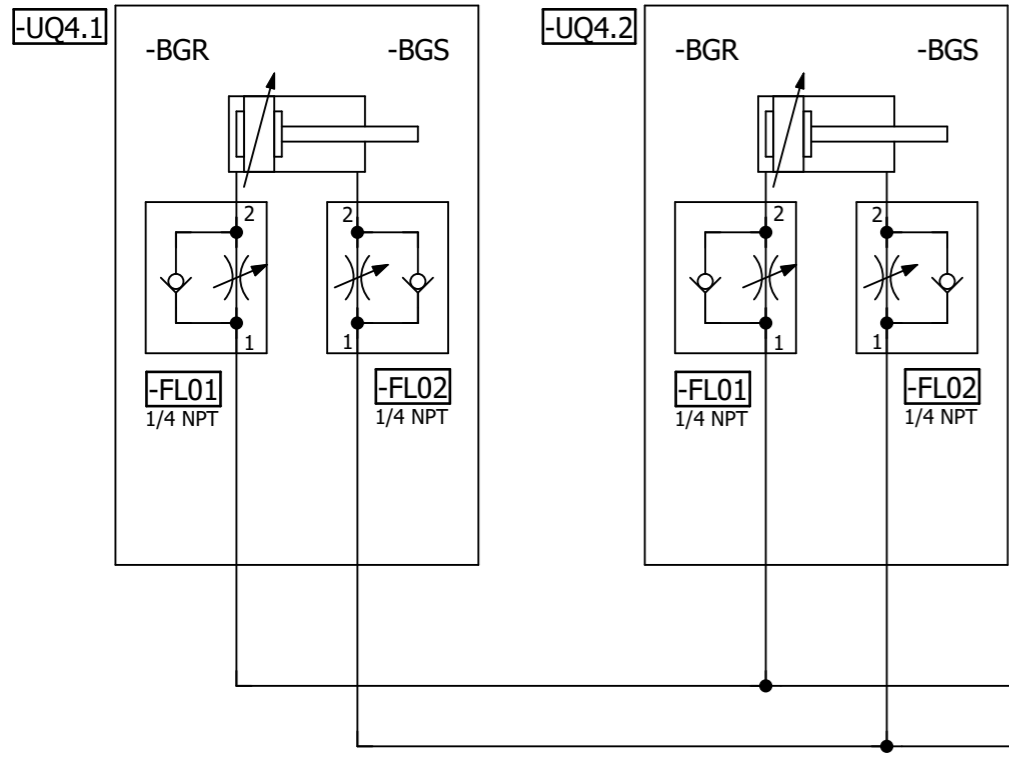

=V1WR1UQ51KF1

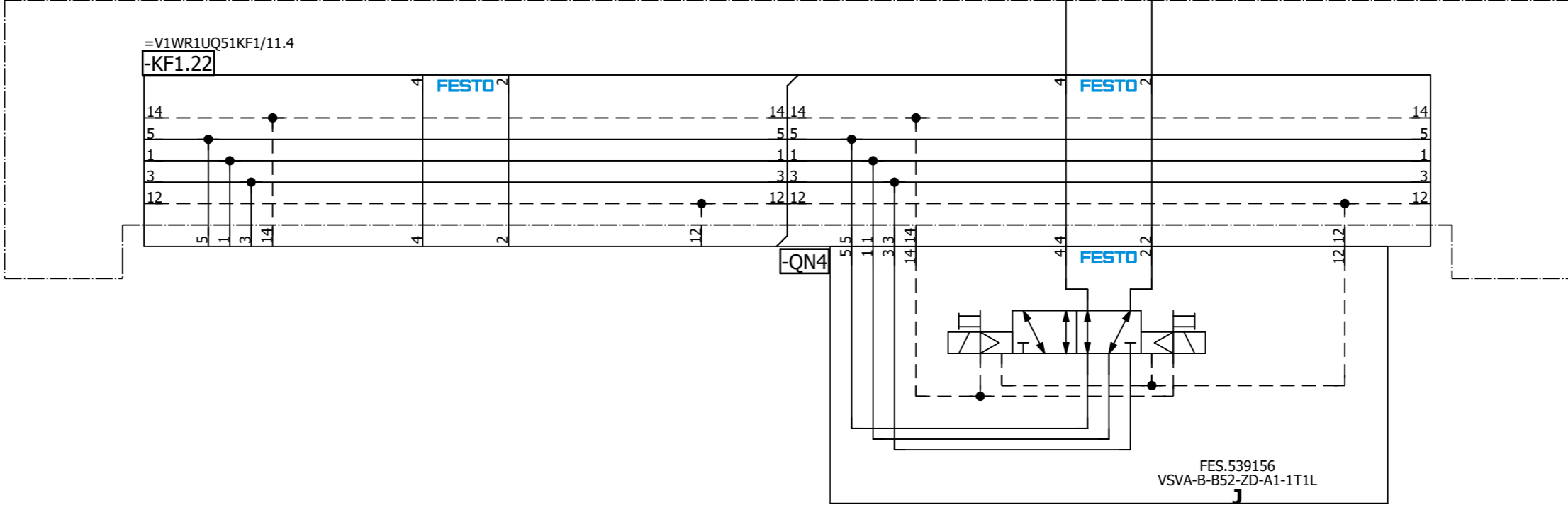

=V1WR1UQ51  
-UQ4-QN4.1  
L230 Model  
Clamps (RST)

=V1WR1UQ51  
-UQ4-QN4.2  
L230 Model  
Clamps (SET)



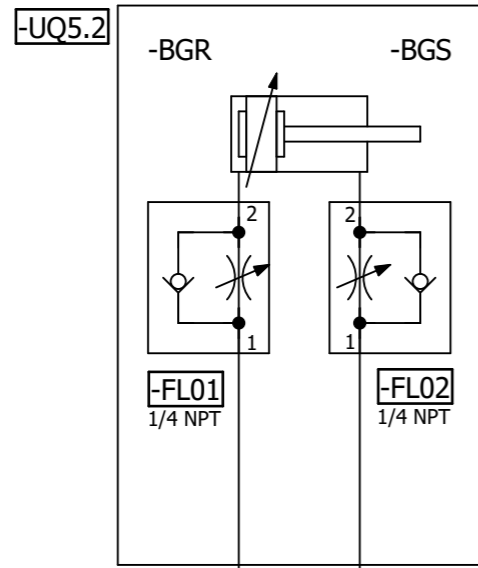
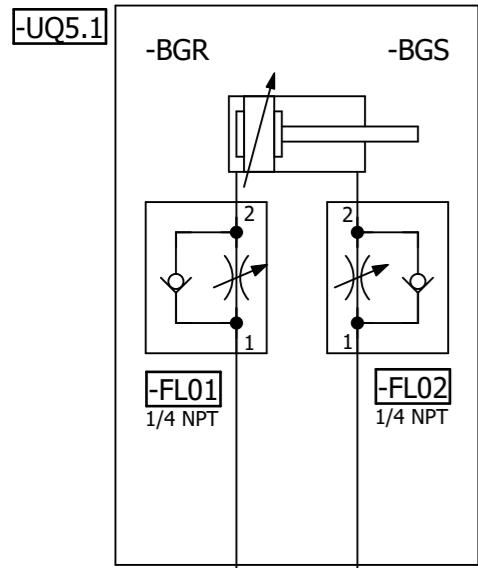

=V1WR1UQ51KF1

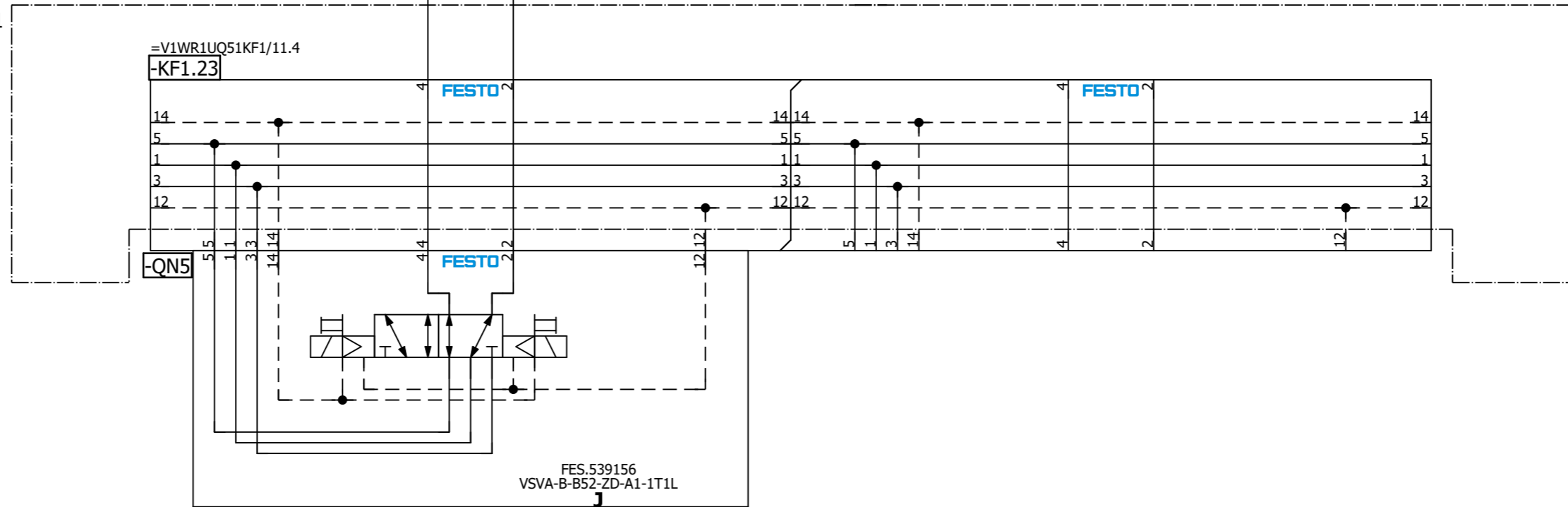

=V1WR1UQ51  
-UQ5-QN5.1  
L290 Model  
Clamps (RST)

=V1WR1UQ51  
-UQ5-QN5.2  
L290 Model  
Clamps (SET)

=V1WR1UQ51UQ4/1

=V1WR1UQ51UQ6/1

Date		12/21/2022	Volvo Trucks North America		Valiant TMS	L290 Model Clamps	Drawing name:		= V1WR1UQ51UQ5
Ed.		MKLEPADLO	P6700 Underbody Mainline - Cell 2V04				Document type:		MFS
Appr.			Replacement of		Scale 1:1	Project nr:		22-16151	Page
Original			Replaced by						1
Modification	Date	Name	Original						227

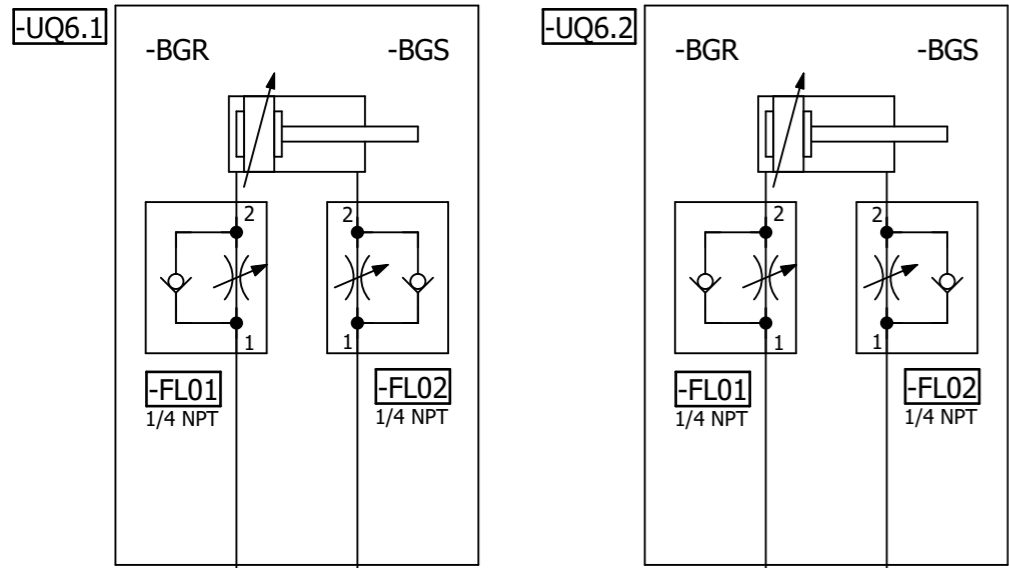

=V1WR1UQ51KF1

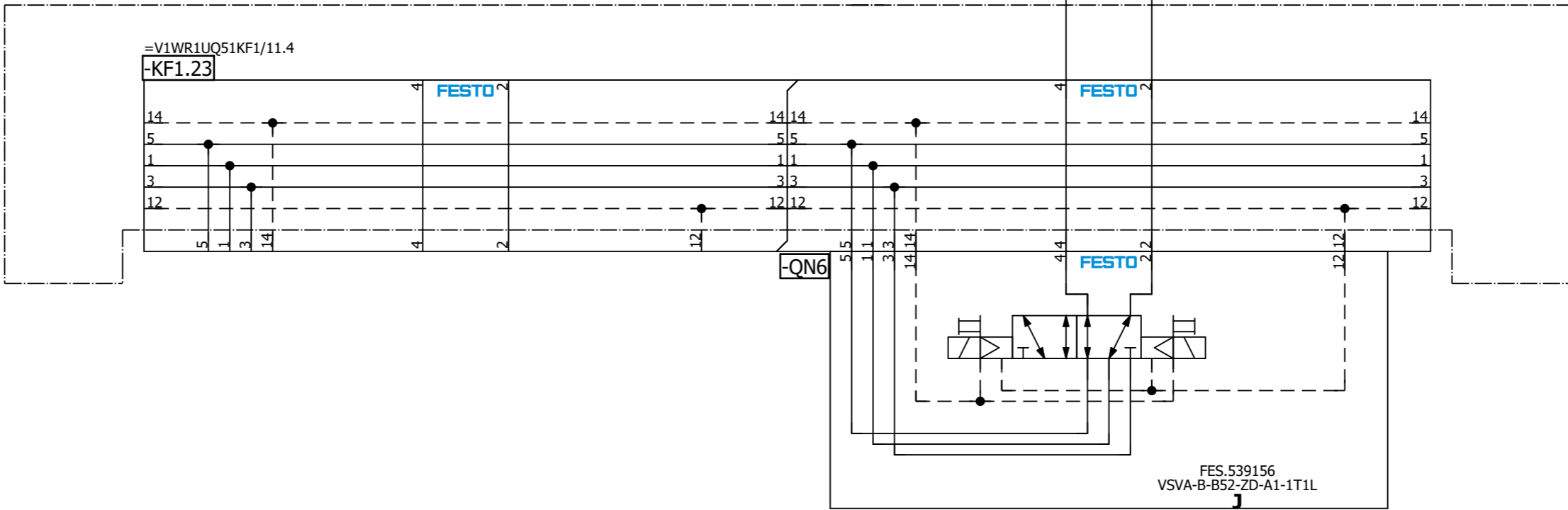

=V1WR1UQ51  
-UQ6-QN6.1  
L320 Model  
Clamps (RST)

=V1WR1UQ51  
-UQ6-QN6.2  
L320 Model  
Clamps (SET)





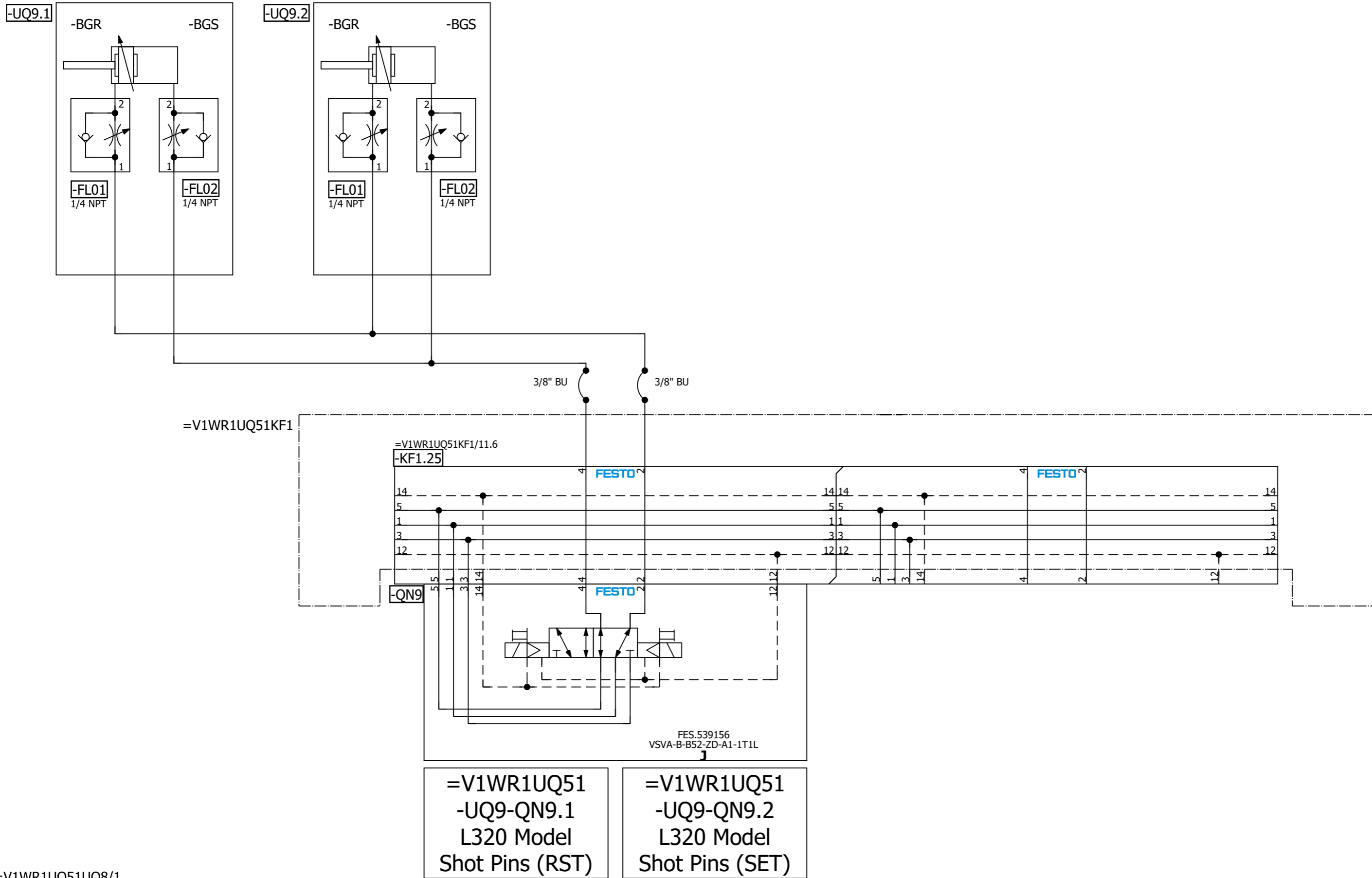

=V1WR1UQ51UQ8/1 =V1WR1UQ51UQ10/1

Date: 12/21/2022		Volvo Trucks North America		Valiant TMS		Drawing name: =2V04&MFS-PNEU		= V1WR1UQ51UQ9	
Ed.: MKLEPADLO		P6700 Underbody Mainline - Cell 2V04		Scale 1:1		Document type: MFS		+ V1WR1UQ51	
Appr:		Replacement of		Replaced by		Project nr: 22-16151		Page 1	
Original								227	

=V1WR1UQ51KF1

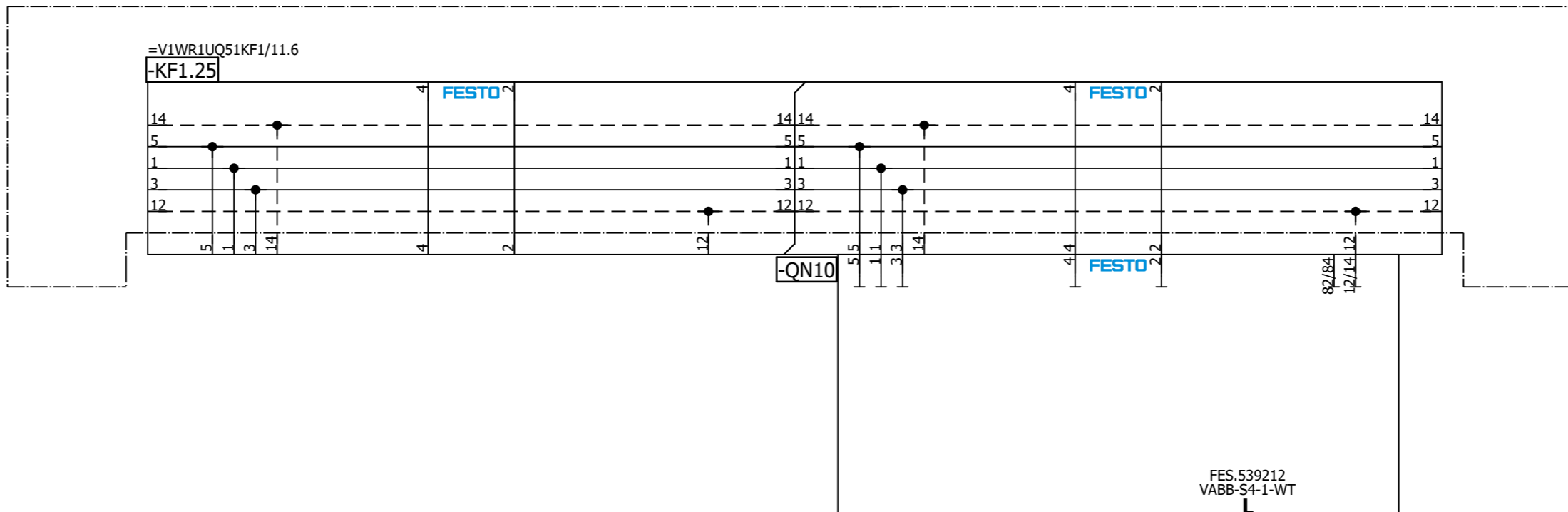

=V1WR1UQ51UQ9/1

&MPB+KH0/1

		Date	12/21/2022	Volvo Trucks North America	Valiant TMS	Spare	Drawing name:		= V1WR1UQ51UQ10			
		Ed.	MKLEPADLO	P6700 Underbody Mainline - Cell 2V04			=2V04&MFS-PNEU		+ V1WR1UQ51		Page	1
Modification	Date	Name	Original	Replacement of	Replaced by	Scale 1:1	Document type:	MFS	Project nr:	22-16151	Page	1
											227	







# Parts list

F01\_001

Device tag	Quantity	Designation	Type number	Supplier	Part number
=V1AR11UQ41KF1-KF1.0	1	Valve Manifold	51E-F33GCQPNMKBNMKBNMK-B-D-UL1+GS2GZBA & 32P-TJQ-R-MBHBHBHBH-8J	FES.MBHBHBHBH-8J	FES.51E-F33GCQPNMKBNMKBNMK-B-D-UL1+GS2GZBA & 32P-TJQ-R-MBHBHBHBH-8J
=V1AR11UQ41KF1-KF1.21	0	Subbase	VMPA2-FB-AP-2-1		FES.538000
=V1AR11UQ41KF1-KF1.22	0	Subbase	VMPA2-FB-AP-2-1		FES.538000
=V1AR11UQ41KF1-KF1.23	0	Subbase	VMPA2-FB-AP-2-1		FES.538000
=V1AR11UQ41KF1-KF1.24	0	Subbase	VMPA2-FB-AP-2-1		FES.538000
=V1AR11UQ41KF2-KF2.0	1	Valve Manifold	51E-F33GCQPNMKBNMKBNMK-B-D-UL1+GS2GZBA & 32P-TJQ-R-MBHBHBHBH-8J	FES.MBHBHBHBH-8J	FES.51E-F33GCQPNMKBNMKBNMK-B-D-UL1+GS2GZBA & 32P-TJQ-R-MBHBHBHBH-8J
=V1AR11UQ41KF2-KF2.21	0	Subbase	VMPA2-FB-AP-2-1		FES.538000
=V1AR11UQ41KF2-KF2.22	0	Subbase	VMPA2-FB-AP-2-1		FES.538000
=V1AR11UQ41KF2-KF2.23	0	Subbase	VMPA2-FB-AP-2-1		FES.538000
=V1AR11UQ41KF2-KF2.24	0	Subbase	VMPA2-FB-AP-2-1		FES.538000
=V1AR11UQ41KF3-KF3.0	1	Valve Manifold	51E-F33GCQPNMKBNMKBNMK-B-D-UL1+GS2GZBA & 32P-TJQ-R-MBHBHBHBH-8J	FES.MBHBHBHBH-8J	FES.51E-F33GCQPNMKBNMKBNMK-B-D-UL1+GS2GZBA & 32P-TJQ-R-MBHBHBHBH-8J
=V1AR11UQ41KF3-KF3.21	0	Subbase	VMPA2-FB-AP-2-1		FES.538000
=V1AR11UQ41KF3-KF3.22	0	Subbase	VMPA2-FB-AP-2-1		FES.538000
=V1AR11UQ41KF3-KF3.23	0	Subbase	VMPA2-FB-AP-2-1		FES.538000
=V1AR11UQ41KF3-KF3.24	0	Subbase	VMPA2-FB-AP-2-1		FES.538000
=V1AR11UQ41UQ1-QN1	0	Solenoid valve	VMPA2-M1H-J-PI		FES.537953
=V1AR11UQ41UQ1-UQ1.1-FL01	1	One-way flow control valve	GRLA-1/4-QB-3/8-U		FES.534663
=V1AR11UQ41UQ1-UQ1.1-FL02	1	One-way flow control valve	GRLA-1/4-QB-3/8-U		FES.534663
=V1AR11UQ41UQ2-QN2	0	Solenoid valve	VMPA2-M1H-J-PI		FES.537953
=V1AR11UQ41UQ2-UQ2.1-FL01	1	One-way flow control valve	GRLA-1/4-QB-3/8-U		FES.534663
=V1AR11UQ41UQ2-UQ2.1-FL02	1	One-way flow control valve	GRLA-1/4-QB-3/8-U		FES.534663
=V1AR11UQ41UQ3-QN3	0	Solenoid valve	VMPA2-M1H-J-PI		FES.537953
=V1AR11UQ41UQ3-UQ3.1-FL01	1	One-way flow control valve	GRLA-1/4-QB-3/8-U		FES.534663
=V1AR11UQ41UQ3-UQ3.1-FL02	1	One-way flow control valve	GRLA-1/4-QB-3/8-U		FES.534663
=V1AR11UQ41UQ3-UQ3.2-FL01	1	One-way flow control valve	GRLA-1/4-QB-3/8-U		FES.534663
=V1AR11UQ41UQ3-UQ3.2-FL02	1	One-way flow control valve	GRLA-1/4-QB-3/8-U		FES.534663
=V1AR11UQ41UQ4-QN4	0	Solenoid valve	VMPA2-M1H-J-PI		FES.537953
=V1AR11UQ41UQ4-UQ4.1-FL01	1	One-way flow control valve	GRLA-1/4-QB-3/8-U		FES.534663
=V1AR11UQ41UQ4-UQ4.1-FL02	1	One-way flow control valve	GRLA-1/4-QB-3/8-U		FES.534663
=V1AR11UQ41UQ4-UQ4.2-FL01	1	One-way flow control valve	GRLA-1/4-QB-3/8-U		FES.534663
=V1AR11UQ41UQ4-UQ4.2-FL02	1	One-way flow control valve	GRLA-1/4-QB-3/8-U		FES.534663
=V1AR11UQ41UQ4-UQ4.3-FL01	1	One-way flow control valve	GRLA-1/4-QB-3/8-U		FES.534663
=V1AR11UQ41UQ4-UQ4.3-FL02	1	One-way flow control valve	GRLA-1/4-QB-3/8-U		FES.534663
=V1AR11UQ41UQ4-UQ4.4-FL01	1	One-way flow control valve	GRLA-1/4-QB-3/8-U		FES.534663
=V1AR11UQ41UQ4-UQ4.4-FL02	1	One-way flow control valve	GRLA-1/4-QB-3/8-U		FES.534663
=V1AR11UQ41UQ5-QN5	0	Solenoid valve	VMPA2-M1H-J-PI		FES.537953
=V1AR11UQ41UQ5-UQ5.1-FL01	1	One-way flow control valve	GRLA-1/4-QB-3/8-U		FES.534663
=V1AR11UQ41UQ5-UQ5.1-FL02	1	One-way flow control valve	GRLA-1/4-QB-3/8-U		FES.534663
=V1AR11UQ41UQ5-UQ5.2-FL01	1	One-way flow control valve	GRLA-1/4-QB-3/8-U		FES.534663
=V1AR11UQ41UQ5-UQ5.2-FL02	1	One-way flow control valve	GRLA-1/4-QB-3/8-U		FES.534663
=V1AR11UQ41UQ5-UQ5.3-FL01	1	One-way flow control valve	GRLA-1/4-QB-3/8-U		FES.534663
=V1AR11UQ41UQ5-UQ5.3-FL02	1	One-way flow control valve	GRLA-1/4-QB-3/8-U		FES.534663
=V1AR11UQ41UQ5-UQ5.4-FL01	1	One-way flow control valve	GRLA-1/4-QB-3/8-U		FES.534663
=V1AR11UQ41UQ5-UQ5.4-FL02	1	One-way flow control valve	GRLA-1/4-QB-3/8-U		FES.534663
=V1AR11UQ41UQ6-QN6	0	Solenoid valve	VMPA2-M1H-J-PI		FES.537953
=V1AR11UQ41UQ6-UQ6.1-FL01	1	One-way flow control valve	GRLA-1/4-QB-3/8-U		FES.534663
=V1AR11UQ41UQ6-UQ6.1-FL02	1	One-way flow control valve	GRLA-1/4-QB-3/8-U		FES.534663
=V1AR11UQ41UQ7-QN7	0	Solenoid valve	VMPA2-M1H-J-PI		FES.537953
=V1AR11UQ41UQ8-QN8	0	Solenoid valve	VMPA2-M1H-J-PI		FES.537953
=V1AR11UQ41UQ8-UQ8.1-FL01	1	One-way flow control valve	GRLA-1/4-QB-3/8-U		FES.534663
=V1AR11UQ41UQ8-UQ8.1-FL02	1	One-way flow control valve	GRLA-1/4-QB-3/8-U		FES.534663
=V1AR11UQ41UQ8-UQ8.2-FL01	1	One-way flow control valve	GRLA-1/4-QB-3/8-U		FES.534663
=V1AR11UQ41UQ8-UQ8.2-FL02	1	One-way flow control valve	GRLA-1/4-QB-3/8-U		FES.534663
=V1AR11UQ41UQ8-UQ8.3-FL01	1	One-way flow control valve	GRLA-1/4-QB-3/8-U		FES.534663
=V1AR11UQ41UQ8-UQ8.3-FL02	1	One-way flow control valve	GRLA-1/4-QB-3/8-U		FES.534663
=V1AR11UQ41UQ8-UQ8.4-FL01	1	One-way flow control valve	GRLA-1/4-QB-3/8-U		FES.534663

+KH1/1

2

Date	12/20/2022	Volvo Trucks North America	Valiant TMS	Parts list :	Drawing name:	=	
Ed.	MKLEPADLO	P6700 Underbody Mainline - Cell 2V04	Scale 1:1	FES.51E-F33GCQPNMKBNMKBNMK-B-D-UL1+GS2GZBA & 32P-TJQ-R-MBHBHBHBH-8J - FES.534663	2V04&MFS-PNEU	+ V1AR11UQ41	
Appr						Document type:	Project nr:
Modification	Date	Name	Original	Replaced by	MPB	22-16151	1
							227

# Parts list

F01\_001

Device tag	Quantity	Designation	Type number	Supplier	Part number
=V1AR11UQ41UQ8-UQ8.4-FL02	1	One-way flow control valve	GRLA-1/4-QB-3/8-U		FES.534663
=V1AR11UQ41UQ9-QN9	0	Solenoid valve	VMPA2-M1H-J-PI		FES.537953
=V1AR11UQ41UQ9-UQ9.1-FL01	1	One-way flow control valve	GRLA-1/4-QB-3/8-U		FES.534663
=V1AR11UQ41UQ9-UQ9.1-FL02	1	One-way flow control valve	GRLA-1/4-QB-3/8-U		FES.534663
=V1AR11UQ41UQ9-UQ9.2-FL01	1	One-way flow control valve	GRLA-1/4-QB-3/8-U		FES.534663
=V1AR11UQ41UQ9-UQ9.2-FL02	1	One-way flow control valve	GRLA-1/4-QB-3/8-U		FES.534663
=V1AR11UQ41UQ10-QN10	0	Solenoid valve	VMPA2-M1H-J-PI		FES.537953
=V1AR11UQ41UQ10-UQ10.1-FL01	1	One-way flow control valve	GRLA-1/4-QB-3/8-U		FES.534663
=V1AR11UQ41UQ10-UQ10.1-FL02	1	One-way flow control valve	GRLA-1/4-QB-3/8-U		FES.534663
=V1AR11UQ41UQ10-UQ10.2-FL01	1	One-way flow control valve	GRLA-1/4-QB-3/8-U		FES.534663
=V1AR11UQ41UQ10-UQ10.2-FL02	1	One-way flow control valve	GRLA-1/4-QB-3/8-U		FES.534663
=V1AR11UQ41UQ11-QN11	0	Solenoid valve	VMPA2-M1H-J-PI		FES.537953
=V1AR11UQ41UQ11-UQ11.1-FL01	1	One-way flow control valve	GRLA-1/4-QB-3/8-U		FES.534663
=V1AR11UQ41UQ11-UQ11.1-FL02	1	One-way flow control valve	GRLA-1/4-QB-3/8-U		FES.534663
=V1AR11UQ41UQ12-QN12	0	Solenoid valve	VMPA2-M1H-J-PI		FES.537953
=V1AR11UQ41UQ13-QN13	0	Solenoid valve	VMPA2-M1H-J-PI		FES.537953
=V1AR11UQ41UQ14-QN14	0	Solenoid valve	VMPA2-M1H-J-PI		FES.537953
=V1AR11UQ41UQ14-UQ14.1-FL01	1	One-way flow control valve	GRLA-1/4-QB-3/8-U		FES.534663
=V1AR11UQ41UQ14-UQ14.1-FL02	1	One-way flow control valve	GRLA-1/4-QB-3/8-U		FES.534663
=V1AR11UQ41UQ14-UQ14.2-FL01	1	One-way flow control valve	GRLA-1/4-QB-3/8-U		FES.534663
=V1AR11UQ41UQ14-UQ14.2-FL02	1	One-way flow control valve	GRLA-1/4-QB-3/8-U		FES.534663
=V1AR11UQ41UQ15-QN15	0	Solenoid valve	VMPA2-M1H-J-PI		FES.537953
=V1AR11UQ41UQ15-UQ15.1-FL01	1	One-way flow control valve	GRLA-1/4-QB-3/8-U		FES.534663
=V1AR11UQ41UQ15-UQ15.1-FL02	1	One-way flow control valve	GRLA-1/4-QB-3/8-U		FES.534663
=V1AR11UQ41UQ15-UQ15.2-FL01	1	One-way flow control valve	GRLA-1/4-QB-3/8-U		FES.534663
=V1AR11UQ41UQ15-UQ15.2-FL02	1	One-way flow control valve	GRLA-1/4-QB-3/8-U		FES.534663
=V1AR11UQ41UQ16-QN16	0	Solenoid valve	VMPA2-M1H-J-PI		FES.537953
=V1AR11UQ41UQ16-UQ16.1-FL01	1	One-way flow control valve	GRLA-1/4-QB-3/8-U		FES.534663
=V1AR11UQ41UQ16-UQ16.1-FL02	1	One-way flow control valve	GRLA-1/4-QB-3/8-U		FES.534663
=V1AR11UQ41UQ16-UQ16.2-FL01	1	One-way flow control valve	GRLA-1/4-QB-3/8-U		FES.534663
=V1AR11UQ41UQ16-UQ16.2-FL02	1	One-way flow control valve	GRLA-1/4-QB-3/8-U		FES.534663
=V1AR11UQ41UQ17-QN17	0	Solenoid valve	VMPA2-M1H-J-PI		FES.537953
=V1AR11UQ41UQ17-UQ17.1-FL01	1	One-way flow control valve	GRLA-1/4-QB-3/8-U		FES.534663
=V1AR11UQ41UQ17-UQ17.1-FL02	1	One-way flow control valve	GRLA-1/4-QB-3/8-U		FES.534663
=V1AR11UQ41UQ18-QN18	0	Solenoid valve	VMPA2-M1H-J-PI		FES.537953
=V1AR11UQ41UQ19-QN19	0	Solenoid valve	VMPA2-M1H-J-PI		FES.537953
=V1AR11UQ41UQ20-QN20	0	Solenoid valve	VMPA2-M1H-J-PI		FES.537953
=V1AR11UQ41UQ20-UQ20.1-FL01	1	One-way flow control valve	GRLA-1/4-QB-3/8-U		FES.534663
=V1AR11UQ41UQ20-UQ20.1-FL02	1	One-way flow control valve	GRLA-1/4-QB-3/8-U		FES.534663
=V1AR11UQ41UQ20-UQ20.2-FL01	1	One-way flow control valve	GRLA-1/4-QB-3/8-U		FES.534663
=V1AR11UQ41UQ20-UQ20.2-FL02	1	One-way flow control valve	GRLA-1/4-QB-3/8-U		FES.534663
=V1AR11UQ41UQ21-QN21	0	Solenoid valve	VMPA2-M1H-J-PI		FES.537953
=V1AR11UQ41UQ21-UQ21.1-FL01	1	One-way flow control valve	GRLA-1/4-QB-3/8-U		FES.534663
=V1AR11UQ41UQ21-UQ21.1-FL02	1	One-way flow control valve	GRLA-1/4-QB-3/8-U		FES.534663
=V1AR11UQ41UQ21-UQ21.2-FL01	1	One-way flow control valve	GRLA-1/4-QB-3/8-U		FES.534663
=V1AR11UQ41UQ21-UQ21.2-FL02	1	One-way flow control valve	GRLA-1/4-QB-3/8-U		FES.534663
=V1AR11UQ41UQ22-QN22	0	Solenoid valve	VMPA2-M1H-J-PI		FES.537953
=V1AR11UQ41UQ22-UQ22.1-FL01	1	One-way flow control valve	GRLA-1/4-QB-3/8-U		FES.534663
=V1AR11UQ41UQ22-UQ22.1-FL02	1	One-way flow control valve	GRLA-1/4-QB-3/8-U		FES.534663
=V1AR11UQ41UQ23-QN23	0	Solenoid valve	VMPA2-M1H-J-PI		FES.537953
=V1AR11UQ41UQ24-QN24	0	Solenoid valve	VMPA2-M1H-J-PI		FES.537953
=V1AR11UQ41UQ24-UQ24.1-FL01	1	One-way flow control valve	GRLA-1/4-QB-3/8-U		FES.534663
=V1AR11UQ41UQ24-UQ24.1-FL02	1	One-way flow control valve	GRLA-1/4-QB-3/8-U		FES.534663
=V1AR11UQ41UQ24-UQ24.2-FL01	1	One-way flow control valve	GRLA-1/4-QB-3/8-U		FES.534663
=V1AR11UQ41UQ24-UQ24.2-FL02	1	One-way flow control valve	GRLA-1/4-QB-3/8-U		FES.534663

1

+ .AR12UQ41/1

Date	12/20/2022	Volvo Trucks North America	Valiant TMS	Parts list : FES.534663 - FES.534663	Drawing name:	=	
Ed.	MKLEPADLO	P6700 Underbody Mainline - Cell 2V04		Scale 1:1	=	+ V1AR11UQ41	
Appr					Document type:	Project nr:	Page
Modification	Date	Name	Original	Replaced by	MPB	22-16151	227

# Parts list

F01\_001

Device tag	Quantity	Designation	Type number	Supplier	Part number
=V1AR12UQ41KF1-KF1.0	1	Valve Manifold	51E-F33GCQPNMKBNMKBNMKB-D-UL1+GS2GZBA & 32P-TJQ-R-MBHBHBHBHBH-10J	FES.MBHBHBHBHBH-10J	FES.51E-F33GCQPNMKBNMKBNMKB-D-UL1+GS2GZBA & 32P-TJQ-R-MBHBHBHBHBH-10J
=V1AR12UQ41KF1-KF1.21	0	Subbase	VMPA2-FB-AP-2-1		FES.538000
=V1AR12UQ41KF1-KF1.22	0	Subbase	VMPA2-FB-AP-2-1		FES.538000
=V1AR12UQ41KF1-KF1.23	0	Subbase	VMPA2-FB-AP-2-1		FES.538000
=V1AR12UQ41KF1-KF1.24	0	Subbase	VMPA2-FB-AP-2-1		FES.538000
=V1AR12UQ41KF1-KF1.25	0	Subbase	VMPA2-FB-AP-2-1		FES.538000
=V1AR12UQ41UQ1-QN1	0	Solenoid valve	VMPA2-M1H-J-PI		FES.537953
=V1AR12UQ41UQ2-QN2	0	Solenoid valve	VMPA2-M1H-J-PI		FES.537953
=V1AR12UQ41UQ3-QN3	0	Solenoid valve	VMPA2-M1H-J-PI		FES.537953
=V1AR12UQ41UQ4-QN4	0	Solenoid valve	VMPA2-M1H-J-PI		FES.537953
=V1AR12UQ41UQ5-QN5	0	Solenoid valve	VMPA2-M1H-J-PI		FES.537953
=V1AR12UQ41UQ5-UQ5.1-FL01	1	One-way flow control valve	GRLA-1/4-QB-3/8-U		FES.534663
=V1AR12UQ41UQ5-UQ5.1-FL02	1	One-way flow control valve	GRLA-1/4-QB-3/8-U		FES.534663
=V1AR12UQ41UQ5-UQ5.2-FL01	1	One-way flow control valve	GRLA-1/4-QB-3/8-U		FES.534663
=V1AR12UQ41UQ5-UQ5.2-FL02	1	One-way flow control valve	GRLA-1/4-QB-3/8-U		FES.534663
=V1AR12UQ41UQ6-QN6	0	Solenoid valve	VMPA2-M1H-J-PI		FES.537953
=V1AR12UQ41UQ6-UQ6.1-FL01	1	One-way flow control valve	GRLA-1/4-QB-3/8-U		FES.534663
=V1AR12UQ41UQ6-UQ6.1-FL02	1	One-way flow control valve	GRLA-1/4-QB-3/8-U		FES.534663
=V1AR12UQ41UQ6-UQ6.2-FL01	1	One-way flow control valve	GRLA-1/4-QB-3/8-U		FES.534663
=V1AR12UQ41UQ6-UQ6.2-FL02	1	One-way flow control valve	GRLA-1/4-QB-3/8-U		FES.534663
=V1AR12UQ41UQ7-QN7	0	Solenoid valve	VMPA2-M1H-J-PI		FES.537953
=V1AR12UQ41UQ7-UQ7.1-FL01	1	One-way flow control valve	GRLA-1/4-QB-3/8-U		FES.534663
=V1AR12UQ41UQ7-UQ7.1-FL02	1	One-way flow control valve	GRLA-1/4-QB-3/8-U		FES.534663
=V1AR12UQ41UQ7-UQ7.2-FL01	1	One-way flow control valve	GRLA-1/4-QB-3/8-U		FES.534663
=V1AR12UQ41UQ7-UQ7.2-FL02	1	One-way flow control valve	GRLA-1/4-QB-3/8-U		FES.534663
=V1AR12UQ41UQ8-QN8	0	Solenoid valve	VMPA2-M1H-J-PI		FES.537953
=V1AR12UQ41UQ8-UQ8.1-FL01	1	One-way flow control valve	GRLA-1/4-QB-3/8-U		FES.534663
=V1AR12UQ41UQ8-UQ8.1-FL02	1	One-way flow control valve	GRLA-1/4-QB-3/8-U		FES.534663
=V1AR12UQ41UQ8-UQ8.2-FL01	1	One-way flow control valve	GRLA-1/4-QB-3/8-U		FES.534663
=V1AR12UQ41UQ8-UQ8.2-FL02	1	One-way flow control valve	GRLA-1/4-QB-3/8-U		FES.534663
=V1AR12UQ41UQ9-QN9	0	Solenoid valve	VMPA2-M1H-J-PI		FES.537953
=V1AR12UQ41UQ9-UQ9.1-FL01	1	One-way flow control valve	GRLA-1/4-QB-3/8-U		FES.534663
=V1AR12UQ41UQ9-UQ9.1-FL02	1	One-way flow control valve	GRLA-1/4-QB-3/8-U		FES.534663
=V1AR12UQ41UQ9-UQ9.2-FL01	1	One-way flow control valve	GRLA-1/4-QB-3/8-U		FES.534663
=V1AR12UQ41UQ9-UQ9.2-FL02	1	One-way flow control valve	GRLA-1/4-QB-3/8-U		FES.534663
=V1AR12UQ41UQ10-QN10	0	Solenoid valve	VMPA2-M1H-J-PI		FES.537953

+ .AR11UQ41/2

+ .AR13UQ41/1

Date	12/20/2022	Volvo Trucks North America	Valiant TMS	Parts list :	Drawing name:	=	
Ed.	MKLEPADLO	P6700 Underbody Mainline - Cell 2V04	Scale 1:1	FES.51E-F33GCQPNMKBNMKBNMKB-D-UL1+GS2GZBA & 32P-TJQ-R-MBHBHBHBHBH-10J - FES.537953	F2V04&MFS-PNEU	+ V1AR12UQ41	
Appr							Document type:
Modification	Date	Name	Original	Replaced by	MPB	22-16151	1
							227







# Parts list

F01\_001

Device tag	Quantity	Designation	Type number	Supplier	Part number
=V1AR14UQ41KF1-KF1.0	1	Valve Manifold	51E-F33GCQPNMKBNMKBNMKB-D-UL1+GS2GZBA & 32P-TJQ-R-MBHBHBHBHBH-10J	FES.MBHBHBHBHBH-10J	FES.51E-F33GCQPNMKBNMKBNMKB-D-UL1+GS2GZBA & 32P-TJQ-R-MBHBHBHBHBH-10J
=V1AR14UQ41KF1-KF1.21	0	Subbase	VMPA2-FB-AP-2-1		FES.538000
=V1AR14UQ41KF1-KF1.22	0	Subbase	VMPA2-FB-AP-2-1		FES.538000
=V1AR14UQ41KF1-KF1.23	0	Subbase	VMPA2-FB-AP-2-1		FES.538000
=V1AR14UQ41KF1-KF1.24	0	Subbase	VMPA2-FB-AP-2-1		FES.538000
=V1AR14UQ41KF1-KF1.25	0	Subbase	VMPA2-FB-AP-2-1		FES.538000
=V1AR14UQ41UQ1-QN1	0	Solenoid valve	VMPA2-M1H-J-PI		FES.537953
=V1AR14UQ41UQ1-UQ1.1-FL01	1	One-way flow control valve	GRLA-1/4-QB-3/8-U		FES.534663
=V1AR14UQ41UQ1-UQ1.1-FL02	1	One-way flow control valve	GRLA-1/4-QB-3/8-U		FES.534663
=V1AR14UQ41UQ1-UQ1.2-FL01	1	One-way flow control valve	GRLA-1/4-QB-3/8-U		FES.534663
=V1AR14UQ41UQ1-UQ1.2-FL02	1	One-way flow control valve	GRLA-1/4-QB-3/8-U		FES.534663
=V1AR14UQ41UQ2-QN2	0	Solenoid valve	VMPA2-M1H-J-PI		FES.537953
=V1AR14UQ41UQ3-QN3	0	Solenoid valve	VMPA2-M1H-J-PI		FES.537953
=V1AR14UQ41UQ4-QN4	0	Solenoid valve	VMPA2-M1H-J-PI		FES.537953
=V1AR14UQ41UQ5-QN5	0	Solenoid valve	VMPA2-M1H-J-PI		FES.537953
=V1AR14UQ41UQ6-QN6	0	Solenoid valve	VMPA2-M1H-J-PI		FES.537953
=V1AR14UQ41UQ6-UQ6.1-FL01	1	One-way flow control valve	GRLA-1/4-QB-3/8-U		FES.534663
=V1AR14UQ41UQ6-UQ6.1-FL02	1	One-way flow control valve	GRLA-1/4-QB-3/8-U		FES.534663
=V1AR14UQ41UQ6-UQ6.2-FL01	1	One-way flow control valve	GRLA-1/4-QB-3/8-U		FES.534663
=V1AR14UQ41UQ6-UQ6.2-FL02	1	One-way flow control valve	GRLA-1/4-QB-3/8-U		FES.534663
=V1AR14UQ41UQ7-QN7	0	Solenoid valve	VMPA2-M1H-J-PI		FES.537953
=V1AR14UQ41UQ7-UQ7.1-FL01	1	One-way flow control valve	GRLA-1/4-QB-3/8-U		FES.534663
=V1AR14UQ41UQ7-UQ7.1-FL02	1	One-way flow control valve	GRLA-1/4-QB-3/8-U		FES.534663
=V1AR14UQ41UQ7-UQ7.2-FL01	1	One-way flow control valve	GRLA-1/4-QB-3/8-U		FES.534663
=V1AR14UQ41UQ7-UQ7.2-FL02	1	One-way flow control valve	GRLA-1/4-QB-3/8-U		FES.534663
=V1AR14UQ41UQ8-QN8	0	Solenoid valve	VMPA2-M1H-J-PI		FES.537953
=V1AR14UQ41UQ8-UQ8.1-FL01	1	One-way flow control valve	GRLA-1/4-QB-3/8-U		FES.534663
=V1AR14UQ41UQ8-UQ8.1-FL02	1	One-way flow control valve	GRLA-1/4-QB-3/8-U		FES.534663
=V1AR14UQ41UQ8-UQ8.2-FL01	1	One-way flow control valve	GRLA-1/4-QB-3/8-U		FES.534663
=V1AR14UQ41UQ8-UQ8.2-FL02	1	One-way flow control valve	GRLA-1/4-QB-3/8-U		FES.534663
=V1AR14UQ41UQ9-QN9	0	Solenoid valve	VMPA2-M1H-J-PI		FES.537953
=V1AR14UQ41UQ9-UQ9.1-FL01	1	One-way flow control valve	GRLA-1/4-QB-3/8-U		FES.534663
=V1AR14UQ41UQ9-UQ9.1-FL02	1	One-way flow control valve	GRLA-1/4-QB-3/8-U		FES.534663
=V1AR14UQ41UQ9-UQ9.2-FL01	1	One-way flow control valve	GRLA-1/4-QB-3/8-U		FES.534663
=V1AR14UQ41UQ9-UQ9.2-FL02	1	One-way flow control valve	GRLA-1/4-QB-3/8-U		FES.534663
=V1AR14UQ41UQ10-QN10	0	Solenoid valve	VMPA2-M1H-J-PI		FES.537953
=V1AR14UQ41UQ10-UQ10.1-FL01	1	One-way flow control valve	GRLA-1/4-QB-3/8-U		FES.534663
=V1AR14UQ41UQ10-UQ10.1-FL02	1	One-way flow control valve	GRLA-1/4-QB-3/8-U		FES.534663
=V1AR14UQ41UQ10-UQ10.2-FL01	1	One-way flow control valve	GRLA-1/4-QB-3/8-U		FES.534663
=V1AR14UQ41UQ10-UQ10.2-FL02	1	One-way flow control valve	GRLA-1/4-QB-3/8-U		FES.534663

+ .AR13UQ41/1

+ .AR15UQ41/1

Date	12/20/2022	Volvo Trucks North America	Valiant TMS	Parts list :	Drawing name:	=	
Ed.	MKLEPADLO	P6700 Underbody Mainline - Cell 2V04	Scale 1:1	FES.51E-F33GCQPNMKBNMKBNMKB-D-UL1+GS2GZBA & 32P-TJQ-R-MBHBHBHBHBH-10J - FES.534663	FES.51E-F33GCQPNMKBNMKBNMKB-D-UL1+GS2GZBA & 32P-TJQ-R-MBHBHBHBHBH-10J	+ V1AR14UQ41	
Appr							Document type:
Modification	Date	Name	Original	Replaced by	MPB	22-16151	1
							227









# Parts list

F01\_001

Device tag	Quantity	Designation	Type number	Supplier	Part number
=V1GL13UQ51KF1-KF1.0	1	Valve Manifold	51E-F33GCQPNMKBNMKBNMKBNMKB-S-UL1+GS2GZBA & 45PN-R-Z-LSMX-3BU-5JL	FES	FES.51E-F33GCQPNMKBNMKBNMKBNMKB-S-UL1+GS2GZBA & 45PN-R-Z-LSMX-3BU-5JL
=V1GL13UQ51KF1-KF1.21	0	Manifold subbase	VABV-S4-1HS-N14-2T2		FES.546213
=V1GL13UQ51KF1-KF1.22	0	Manifold subbase	VABV-S4-1HS-N14-2T2		FES.546213
=V1GL13UQ51KF1-KF1.23	0	Manifold subbase	VABV-S4-1HS-N14-2T2		FES.546213
=V1GL13UQ51UQ1-QN1	0	Solenoid valve	VSVA-B-B52-ZD-A1-1T1L	FES	FES.539156
=V1GL13UQ51UQ1-UQ1.1-FL01	1	One-way flow control valve	GRLA-1/4-QB-3/8-U		FES.534663
=V1GL13UQ51UQ1-UQ1.1-FL02	1	One-way flow control valve	GRLA-1/4-QB-3/8-U		FES.534663
=V1GL13UQ51UQ2-QN2	0	Solenoid valve	VSVA-B-B52-ZD-A1-1T1L	FES	FES.539156
=V1GL13UQ51UQ2-UQ2.1-FL01	1	One-way flow control valve	GRLA-1/4-QB-3/8-U		FES.534663
=V1GL13UQ51UQ2-UQ2.1-FL02	1	One-way flow control valve	GRLA-1/4-QB-3/8-U		FES.534663
=V1GL13UQ51UQ3-QN3	0	Solenoid valve	VSVA-B-B52-ZD-A1-1T1L	FES	FES.539156
=V1GL13UQ51UQ3-UQ3.1-FL01	1	One-way flow control valve	GRLA-1/4-QB-3/8-U		FES.534663
=V1GL13UQ51UQ3-UQ3.1-FL02	1	One-way flow control valve	GRLA-1/4-QB-3/8-U		FES.534663
=V1GL13UQ51UQ4-QN4	0	Solenoid valve	VSVA-B-B52-ZD-A1-1T1L	FES	FES.539156
=V1GL13UQ51UQ4-UQ4.1-FL01	1	One-way flow control valve	GRLA-1/4-QB-3/8-U		FES.534663
=V1GL13UQ51UQ4-UQ4.1-FL02	1	One-way flow control valve	GRLA-1/4-QB-3/8-U		FES.534663
=V1GL13UQ51UQ8-QN5	0	Solenoid valve	VSVA-B-B52-ZD-A1-1T1L	FES	FES.539156
=V1GL13UQ51UQ8-UQ8.1-FL01	1	One-way flow control valve	GRLA-1/4-QB-3/8-U		FES.534663
=V1GL13UQ51UQ8-UQ8.1-FL02	1	One-way flow control valve	GRLA-1/4-QB-3/8-U		FES.534663
=V1GL13UQ51UQx-QN6	0	Blanking plate	VABB-S4-1-WT		FES.539212

+ .GL12UQ51/1

+ .UQ51/1

Date	12/20/2022	Volvo Trucks North America	Valiant TMS	Parts list :	Drawing name:	=	
Ed.	MKLEPADLO	P6700 Underbody Mainline - Cell 2V04		FES.51E-F33GCQPNMKBNMKBNMKBNMKB-S-UL1+GS2GZBA & 45PN-R-Z-LSMX-3BU-5JL - FES.539212	+ V1GL13UQ51		
Appr				Scale 1:1	MPB	Project nr:	22-16151
Modification	Date	Name	Original	Replaced by			1
							227

# Parts list

F01\_001

Device tag	Quantity	Designation	Type number	Supplier	Part number
=V1UQ51KF1-KF1.0	1	Valve Manifold	51E-F33GCQPNMKBNMKB-S-UL1+GS2GZBA & 45PN-R-Z-LSMX-4BU-4JE3J	FES	FES.51E-F33GCQPNMKBNMKB-S-UL1+GS2GZBA & 45PN-R-Z-LSMX-4BU-4JE3J
=V1UQ51KF1-KF1.21	0	Manifold subbase	VABV-S4-1HS-N14-2T2		FES.546213
=V1UQ51KF1-KF1.22	0	Manifold subbase	VABV-S4-1HS-N14-2T2		FES.546213
=V1UQ51KF1-KF1.23	0	Manifold subbase	VABV-S4-1HS-N14-2T2		FES.546213
=V1UQ51KF1-KF1.24	0	Manifold subbase	VABV-S4-1HS-N14-2T2		FES.546213
=V1UQ51KF2-KF2.0	1	Valve Manifold	51E-F33GCQPNMKBNMKB-S-UL1+GS2GZBA & 45PN-R-Z-LSMX-4BU-8J	FES	FES.51E-F33GCQPNMKBNMKB-S-UL1+GS2GZBA & 45PN-R-Z-LSMX-4BU-8J
=V1UQ51KF2-KF2.21	0	Manifold subbase	VABV-S4-1HS-N14-2T2		FES.546213
=V1UQ51KF2-KF2.22	0	Manifold subbase	VABV-S4-1HS-N14-2T2		FES.546213
=V1UQ51KF2-KF2.23	0	Manifold subbase	VABV-S4-1HS-N14-2T2		FES.546213
=V1UQ51KF2-KF2.24	0	Manifold subbase	VABV-S4-1HS-N14-2T2		FES.546213
=V1UQ51KF3-KF3.0	1	Valve Manifold	51E-F33GCQPNMKBNMKB-S-UL1+GS2GZBA & 45PN-R-Z-LSMX-4BU-EE6J	FES	FES.51E-F33GCQPNMKBNMKB-S-UL1+GS2GZBA & 45PN-R-Z-LSMX-4BU-EE6J
=V1UQ51KF3-KF3.21	0	Manifold subbase	VABV-S4-1HS-N14-2T2		FES.546213
=V1UQ51KF3-KF3.22	0	Manifold subbase	VABV-S4-1HS-N14-2T2		FES.546213
=V1UQ51KF3-KF3.23	0	Manifold subbase	VABV-S4-1HS-N14-2T2		FES.546213
=V1UQ51KF3-KF3.24	0	Manifold subbase	VABV-S4-1HS-N14-2T2		FES.546213
=V1UQ51UQ1-QN1	0	Solenoid valve	VSVA-B-B52-ZD-A1-1T1L	FES	FES.539156
=V1UQ51UQ1-UQ1.1-FL01	1	One-way flow control valve	GRLA-1/4-QB-3/8-U		FES.534663
=V1UQ51UQ1-UQ1.1-FL02	1	One-way flow control valve	GRLA-1/4-QB-3/8-U		FES.534663
=V1UQ51UQ1-UQ1.2-FL01	1	One-way flow control valve	GRLA-1/4-QB-3/8-U		FES.534663
=V1UQ51UQ1-UQ1.2-FL02	1	One-way flow control valve	GRLA-1/4-QB-3/8-U		FES.534663
=V1UQ51UQ2-QN2	0	Solenoid valve	VSVA-B-B52-ZD-A1-1T1L	FES	FES.539156
=V1UQ51UQ2-UQ2.1-FL01	1	One-way flow control valve	GRLA-1/4-QB-3/8-U		FES.534663
=V1UQ51UQ2-UQ2.1-FL02	1	One-way flow control valve	GRLA-1/4-QB-3/8-U		FES.534663
=V1UQ51UQ3-QN3	0	Solenoid valve	VSVA-B-B52-ZD-A1-1T1L	FES	FES.539156
=V1UQ51UQ3-UQ3.1-FL01	1	One-way flow control valve	GRLA-1/4-QB-3/8-U		FES.534663
=V1UQ51UQ3-UQ3.1-FL02	1	One-way flow control valve	GRLA-1/4-QB-3/8-U		FES.534663
=V1UQ51UQ3-UQ3.2-FL01	1	One-way flow control valve	GRLA-1/4-QB-3/8-U		FES.534663
=V1UQ51UQ3-UQ3.2-FL02	1	One-way flow control valve	GRLA-1/4-QB-3/8-U		FES.534663
=V1UQ51UQ4-QN4	0	Solenoid valve	VSVA-B-B52-ZD-A1-1T1L	FES	FES.539156
=V1UQ51UQ4-UQ4.1-FL01	1	One-way flow control valve	GRLA-1/4-QB-3/8-U		FES.534663
=V1UQ51UQ4-UQ4.1-FL02	1	One-way flow control valve	GRLA-1/4-QB-3/8-U		FES.534663
=V1UQ51UQ4-UQ4.2-FL01	1	One-way flow control valve	GRLA-1/4-QB-3/8-U		FES.534663
=V1UQ51UQ4-UQ4.2-FL02	1	One-way flow control valve	GRLA-1/4-QB-3/8-U		FES.534663
=V1UQ51UQ5-QN5	0	Solenoid valve	VSVA-B-P53E-ZD-A1-1T1L	FES	FES.539161
=V1UQ51UQ5-QN100	1	3/8" DUAL PO CHECK VALVE, IN-LINE W/MANUAL TRAPPED AIR RELIEF	2768D3904	ROSS CONTROLS	2768D3904
=V1UQ51UQ5-QN101	1	3/8" DUAL PO CHECK VALVE, IN-LINE W/MANUAL TRAPPED AIR RELIEF	2768D3904	ROSS CONTROLS	2768D3904
=V1UQ51UQ5-UQ5.1-FL01	1	One-way flow control valve	GRLA-1/4-QB-3/8-U		FES.534663
=V1UQ51UQ5-UQ5.1-FL02	1	One-way flow control valve	GRLA-1/4-QB-3/8-U		FES.534663
=V1UQ51UQ5-UQ5.2-FL01	1	One-way flow control valve	GRLA-1/4-QB-3/8-U		FES.534663
=V1UQ51UQ5-UQ5.2-FL02	1	One-way flow control valve	GRLA-1/4-QB-3/8-U		FES.534663
=V1UQ51UQ6-QN6	0	Solenoid valve	VSVA-B-B52-ZD-A1-1T1L	FES	FES.539156
=V1UQ51UQ6-UQ6.1-FL01	1	One-way flow control valve	GRLA-1/4-QB-3/8-U		FES.534663
=V1UQ51UQ6-UQ6.1-FL02	1	One-way flow control valve	GRLA-1/4-QB-3/8-U		FES.534663
=V1UQ51UQ6-UQ6.2-FL01	1	One-way flow control valve	GRLA-1/4-QB-3/8-U		FES.534663
=V1UQ51UQ6-UQ6.2-FL02	1	One-way flow control valve	GRLA-1/4-QB-3/8-U		FES.534663
=V1UQ51UQ7-QN7	0	Solenoid valve	VSVA-B-B52-ZD-A1-1T1L	FES	FES.539156
=V1UQ51UQ7-UQ7.1-FL01	1	One-way flow control valve	GRLA-1/4-QB-3/8-U		FES.534663
=V1UQ51UQ7-UQ7.1-FL02	1	One-way flow control valve	GRLA-1/4-QB-3/8-U		FES.534663
=V1UQ51UQ7-UQ7.2-FL01	1	One-way flow control valve	GRLA-1/4-QB-3/8-U		FES.534663
=V1UQ51UQ7-UQ7.2-FL02	1	One-way flow control valve	GRLA-1/4-QB-3/8-U		FES.534663
=V1UQ51UQ7-UQ7.3-FL01	1	One-way flow control valve	GRLA-1/4-QB-3/8-U		FES.534663
=V1UQ51UQ7-UQ7.3-FL02	1	One-way flow control valve	GRLA-1/4-QB-3/8-U		FES.534663
=V1UQ51UQ7-UQ7.4-FL01	1	One-way flow control valve	GRLA-1/4-QB-3/8-U		FES.534663
=V1UQ51UQ7-UQ7.4-FL02	1	One-way flow control valve	GRLA-1/4-QB-3/8-U		FES.534663
=V1UQ51UQ7-UQ7.5-FL01	1	One-way flow control valve	GRLA-1/4-QB-3/8-U		FES.534663
=V1UQ51UQ7-UQ7.5-FL02	1	One-way flow control valve	GRLA-1/4-QB-3/8-U		FES.534663

+ .GL13UQ51/1

2

Date	12/20/2022	Volvo Trucks North America	Valiant TMS	Parts list :	Drawing name:	=	
Ed.	MKLEPADLO	P6700 Underbody Mainline - Cell 2V04		FES.51E-F33GCQPNMKBNMKB-S-UL1+GS2GZBA & 45PN-R-Z-LSMX-4BU-4JE3J - FES.534663	= 2V04&MFS-PNEU	+ V1UQ51	
Appr							Document type:
Modification	Date	Name	Original	Replaced by	MPB	22-16151	1
							227

# Parts list

F01\_001

Device tag	Quantity	Designation	Type number	Supplier	Part number
=V1UQ51UQ7-UQ7.6-FL01	1	One-way flow control valve	GRLA-1/4-QB-3/8-U		FES.534663
=V1UQ51UQ7-UQ7.6-FL02	1	One-way flow control valve	GRLA-1/4-QB-3/8-U		FES.534663
=V1UQ51UQ7-UQ7.7-FL01	1	One-way flow control valve	GRLA-1/4-QB-3/8-U		FES.534663
=V1UQ51UQ7-UQ7.7-FL02	1	One-way flow control valve	GRLA-1/4-QB-3/8-U		FES.534663
=V1UQ51UQ8-QN8	0	Solenoid valve	VSVA-B-B52-ZD-A1-1T1L	FES	FES.539156
=V1UQ51UQ8-UQ8.1-FL01	1	One-way flow control valve	GRLA-1/4-QB-3/8-U		FES.534663
=V1UQ51UQ8-UQ8.1-FL02	1	One-way flow control valve	GRLA-1/4-QB-3/8-U		FES.534663
=V1UQ51UQ8-UQ8.2-FL01	1	One-way flow control valve	GRLA-1/4-QB-3/8-U		FES.534663
=V1UQ51UQ8-UQ8.2-FL02	1	One-way flow control valve	GRLA-1/4-QB-3/8-U		FES.534663
=V1UQ51UQ9-QN9	0	Solenoid valve	VSVA-B-B52-ZD-A1-1T1L	FES	FES.539156
=V1UQ51UQ9-UQ9.1-FL01	1	One-way flow control valve	GRLA-1/4-QB-3/8-U		FES.534663
=V1UQ51UQ9-UQ9.1-FL02	1	One-way flow control valve	GRLA-1/4-QB-3/8-U		FES.534663
=V1UQ51UQ9-UQ9.2-FL01	1	One-way flow control valve	GRLA-1/4-QB-3/8-U		FES.534663
=V1UQ51UQ9-UQ9.2-FL02	1	One-way flow control valve	GRLA-1/4-QB-3/8-U		FES.534663
=V1UQ51UQ9-UQ9.3-FL01	1	One-way flow control valve	GRLA-1/4-QB-3/8-U		FES.534663
=V1UQ51UQ9-UQ9.3-FL02	1	One-way flow control valve	GRLA-1/4-QB-3/8-U		FES.534663
=V1UQ51UQ9-UQ9.4-FL01	1	One-way flow control valve	GRLA-1/4-QB-3/8-U		FES.534663
=V1UQ51UQ9-UQ9.4-FL02	1	One-way flow control valve	GRLA-1/4-QB-3/8-U		FES.534663
=V1UQ51UQ10-QN10	0	Solenoid valve	VSVA-B-B52-ZD-A1-1T1L	FES	FES.539156
=V1UQ51UQ10-UQ10.1-FL01	1	One-way flow control valve	GRLA-1/4-QB-3/8-U		FES.534663
=V1UQ51UQ10-UQ10.1-FL02	1	One-way flow control valve	GRLA-1/4-QB-3/8-U		FES.534663
=V1UQ51UQ10-UQ10.2-FL01	1	One-way flow control valve	GRLA-1/4-QB-3/8-U		FES.534663
=V1UQ51UQ10-UQ10.2-FL02	1	One-way flow control valve	GRLA-1/4-QB-3/8-U		FES.534663
=V1UQ51UQ11-QN11	0	Solenoid valve	VSVA-B-B52-ZD-A1-1T1L	FES	FES.539156
=V1UQ51UQ11-UQ11.1-FL01	1	One-way flow control valve	GRLA-1/4-QB-3/8-U		FES.534663
=V1UQ51UQ11-UQ11.1-FL02	1	One-way flow control valve	GRLA-1/4-QB-3/8-U		FES.534663
=V1UQ51UQ12-QN12	0	Solenoid valve	VSVA-B-B52-ZD-A1-1T1L	FES	FES.539156
=V1UQ51UQ12-UQ12.1-FL01	1	One-way flow control valve	GRLA-1/4-QB-3/8-U		FES.534663
=V1UQ51UQ12-UQ12.1-FL02	1	One-way flow control valve	GRLA-1/4-QB-3/8-U		FES.534663
=V1UQ51UQ13-QN3	0	Solenoid valve	VSVA-B-B52-ZD-A1-1T1L	FES	FES.539156
=V1UQ51UQ13-UQ13.1-FL01	1	One-way flow control valve	GRLA-1/4-QB-3/8-U		FES.534663
=V1UQ51UQ13-UQ13.1-FL02	1	One-way flow control valve	GRLA-1/4-QB-3/8-U		FES.534663
=V1UQ51UQ14-QN14	0	Solenoid valve	VSVA-B-B52-ZD-A1-1T1L	FES	FES.539156
=V1UQ51UQ14-UQ14.1-FL01	1	One-way flow control valve	GRLA-1/4-QB-3/8-U		FES.534663
=V1UQ51UQ14-UQ14.1-FL02	1	One-way flow control valve	GRLA-1/4-QB-3/8-U		FES.534663
=V1UQ51UQ14-UQ14.2-FL01	1	One-way flow control valve	GRLA-1/4-QB-3/8-U		FES.534663
=V1UQ51UQ14-UQ14.2-FL02	1	One-way flow control valve	GRLA-1/4-QB-3/8-U		FES.534663
=V1UQ51UQ15-QN15	0	Solenoid valve	VSVA-B-B52-ZD-A1-1T1L	FES	FES.539156
=V1UQ51UQ15-UQ15.1-FL01	1	One-way flow control valve	GRLA-1/4-QB-3/8-U		FES.534663
=V1UQ51UQ15-UQ15.1-FL02	1	One-way flow control valve	GRLA-1/4-QB-3/8-U		FES.534663
=V1UQ51UQ15-UQ15.2-FL01	1	One-way flow control valve	GRLA-1/4-QB-3/8-U		FES.534663
=V1UQ51UQ15-UQ15.2-FL02	1	One-way flow control valve	GRLA-1/4-QB-3/8-U		FES.534663
=V1UQ51UQ16-QN16	0	Solenoid valve	VSVA-B-B52-ZD-A1-1T1L	FES	FES.539156
=V1UQ51UQ16-UQ16.1-FL01	1	One-way flow control valve	GRLA-1/4-QB-3/8-U		FES.534663
=V1UQ51UQ16-UQ16.1-FL02	1	One-way flow control valve	GRLA-1/4-QB-3/8-U		FES.534663
=V1UQ51UQ17-QN17	0	Solenoid valve	VSVA-B-P53E-ZD-A1-1T1L	FES	FES.539161
=V1UQ51UQ17-QN100	1	3/8" DUAL PO CHECK VALVE, IN-LINE W/MANUAL TRAPPED AIR RELIEF	2768D3904	ROSS CONTROLS	2768D3904
=V1UQ51UQ17-UQ17.1-FL01	1	One-way flow control valve	GRLA-1/4-QB-3/8-U		FES.534663
=V1UQ51UQ17-UQ17.1-FL02	1	One-way flow control valve	GRLA-1/4-QB-3/8-U		FES.534663
=V1UQ51UQ18-QN18	0	Solenoid valve	VSVA-B-P53E-ZD-A1-1T1L	FES	FES.539161
=V1UQ51UQ18-QN100	1	3/8" DUAL PO CHECK VALVE, IN-LINE W/MANUAL TRAPPED AIR RELIEF	2768D3904	ROSS CONTROLS	2768D3904
=V1UQ51UQ18-UQ18.1-FL01	1	One-way flow control valve	GRLA-1/4-QB-3/8-U		FES.534663
=V1UQ51UQ18-UQ18.1-FL02	1	One-way flow control valve	GRLA-1/4-QB-3/8-U		FES.534663
=V1UQ51UQ19-QN19	0	Solenoid valve	VSVA-B-B52-ZD-A1-1T1L	FES	FES.539156
=V1UQ51UQ19-UQ19.1-FL01	1	One-way flow control valve	GRLA-1/4-QB-3/8-U		FES.534663
=V1UQ51UQ19-UQ19.1-FL02	1	One-way flow control valve	GRLA-1/4-QB-3/8-U		FES.534663

1

3

Date	12/20/2022	Volvo Trucks North America	Valiant TMS	Parts list : FES.534663 - FES.534663	Drawing name:	=		
Ed.	MKLEPADLO	 P6700 Underbody Mainline - Cell 2V04	Scale 1:1		=2V04&MFS-PNEU	+ V1UQ51		
Appr					Document type:	Project nr:	Page	2
Modification	Date	Name	Original	Replacement of	Replaced by	MPB	22-16151	227

0

1

2

3

4

5

6

7

8

9

# Parts list

F01\_001

Device tag	Quantity	Designation	Type number	Supplier	Part number
=V1UQ51UQ19-UQ19.2-FL01	1	One-way flow control valve	GRLA-1/4-QB-3/8-U		FES.534663
=V1UQ51UQ19-UQ19.2-FL02	1	One-way flow control valve	GRLA-1/4-QB-3/8-U		FES.534663
=V1UQ51UQ20-QN20	0	Solenoid valve	VSVA-B-B52-ZD-A1-1T1L	FES	FES.539156
=V1UQ51UQ20-UQ20.1-FL01	1	One-way flow control valve	GRLA-1/4-QB-3/8-U		FES.534663
=V1UQ51UQ20-UQ20.1-FL02	1	One-way flow control valve	GRLA-1/4-QB-3/8-U		FES.534663
=V1UQ51UQ20-UQ20.2-FL01	1	One-way flow control valve	GRLA-1/4-QB-3/8-U		FES.534663
=V1UQ51UQ20-UQ20.2-FL02	1	One-way flow control valve	GRLA-1/4-QB-3/8-U		FES.534663
=V1UQ51UQ21-QN21	0	Solenoid valve	VSVA-B-B52-ZD-A1-1T1L	FES	FES.539156
=V1UQ51UQ21-UQ21.1-FL01	1	One-way flow control valve	GRLA-1/4-QB-3/8-U		FES.534663
=V1UQ51UQ21-UQ21.1-FL02	1	One-way flow control valve	GRLA-1/4-QB-3/8-U		FES.534663
=V1UQ51UQ21-UQ21.2-FL01	1	One-way flow control valve	GRLA-1/4-QB-3/8-U		FES.534663
=V1UQ51UQ21-UQ21.2-FL02	1	One-way flow control valve	GRLA-1/4-QB-3/8-U		FES.534663
=V1UQ51UQ22-QN22	0	Solenoid valve	VSVA-B-B52-ZD-A1-1T1L	FES	FES.539156
=V1UQ51UQ22-UQ22.1-FL01	1	One-way flow control valve	GRLA-1/4-QB-3/8-U		FES.534663
=V1UQ51UQ22-UQ22.1-FL02	1	One-way flow control valve	GRLA-1/4-QB-3/8-U		FES.534663
=V1UQ51UQ22-UQ22.2-FL01	1	One-way flow control valve	GRLA-1/4-QB-3/8-U		FES.534663
=V1UQ51UQ22-UQ22.2-FL02	1	One-way flow control valve	GRLA-1/4-QB-3/8-U		FES.534663
=V1UQ51UQ22-UQ22.3-FL01	1	One-way flow control valve	GRLA-1/4-QB-3/8-U		FES.534663
=V1UQ51UQ22-UQ22.3-FL02	1	One-way flow control valve	GRLA-1/4-QB-3/8-U		FES.534663
=V1UQ51UQ22-UQ22.4-FL01	1	One-way flow control valve	GRLA-1/4-QB-3/8-U		FES.534663
=V1UQ51UQ22-UQ22.4-FL02	1	One-way flow control valve	GRLA-1/4-QB-3/8-U		FES.534663
=V1UQ51UQ23-QN23	0	Solenoid valve	VSVA-B-B52-ZD-A1-1T1L	FES	FES.539156
=V1UQ51UQ23-UQ23.1-FL01	1	One-way flow control valve	GRLA-1/4-QB-3/8-U		FES.534663
=V1UQ51UQ23-UQ23.1-FL02	1	One-way flow control valve	GRLA-1/4-QB-3/8-U		FES.534663
=V1UQ51UQ24-QN24	0	Solenoid valve	VSVA-B-B52-ZD-A1-1T1L	FES	FES.539156
=V1UQ51UQ24-UQ24.1-FL01	1	One-way flow control valve	GRLA-1/4-QB-3/8-U		FES.534663
=V1UQ51UQ24-UQ24.1-FL02	1	One-way flow control valve	GRLA-1/4-QB-3/8-U		FES.534663

2

+ .UQ52/1

Date	12/20/2022	Volvo Trucks North America	Valiant TMS	Parts list : FES.534663 - FES.534663	Drawing name:	=
Ed.	MKLEPADLO				=2V04&MFS-PNEU	+ V1UQ51
Appr		P6700 Underbody Mainline - Cell 2V04			Document type:	Project nr:
Original		Replacement of	Replaced by	Scale 1:1	MPB	22-16151
Modification	Date	Name				Page 3
						227







# Parts list

F01\_001

Device tag	Quantity	Designation	Type number	Supplier	Part number
=V1UQ53KF1-KF1.0	1	Valve Manifold	51E-F33GCQPNMKBNMKB-S-UL1+GS2GZBA & 45PN-R-Z-LSMX-3BU-4JSAJ	FES	FES.51E-F33GCQPNMKBNMKB-S-UL1+GS2GZBA & 45PN-R-Z-LSMX-3BU-4JSAJ
=V1UQ53KF1-KF1.21	0	Manifold subbase	VABV-S4-1HS-N14-2T2		FES.546213
=V1UQ53KF1-KF1.22	0	Manifold subbase	VABV-S4-1HS-N14-2T2		FES.546213
=V1UQ53KF1-KF1.23	0	Manifold subbase	VABV-S4-1HS-N14-2T2		FES.546213
=V1UQ53UQ1-QN1	0	Solenoid valve	VSVA-B-B52-ZD-A1-1T1L	FES	FES.539156
=V1UQ53UQ1-UQ1.1-FL01	1	One-way flow control valve	GRLA-1/4-QB-3/8-U		FES.534663
=V1UQ53UQ1-UQ1.1-FL02	1	One-way flow control valve	GRLA-1/4-QB-3/8-U		FES.534663
=V1UQ53UQ1-UQ1.2-FL01	1	One-way flow control valve	GRLA-1/4-QB-3/8-U		FES.534663
=V1UQ53UQ1-UQ1.2-FL02	1	One-way flow control valve	GRLA-1/4-QB-3/8-U		FES.534663
=V1UQ53UQ1-UQ1.3-FL01	1	One-way flow control valve	GRLA-1/4-QB-3/8-U		FES.534663
=V1UQ53UQ1-UQ1.3-FL02	1	One-way flow control valve	GRLA-1/4-QB-3/8-U		FES.534663
=V1UQ53UQ1-UQ1.4-FL01	1	One-way flow control valve	GRLA-1/4-QB-3/8-U		FES.534663
=V1UQ53UQ1-UQ1.4-FL02	1	One-way flow control valve	GRLA-1/4-QB-3/8-U		FES.534663
=V1UQ53UQ2-QN2	0	Solenoid valve	VSVA-B-B52-ZD-A1-1T1L	FES	FES.539156
=V1UQ53UQ2-UQ2.1-FL01	1	One-way flow control valve	GRLA-1/4-QB-3/8-U		FES.534663
=V1UQ53UQ2-UQ2.1-FL02	1	One-way flow control valve	GRLA-1/4-QB-3/8-U		FES.534663
=V1UQ53UQ2-UQ2.2-FL01	1	One-way flow control valve	GRLA-1/4-QB-3/8-U		FES.534663
=V1UQ53UQ2-UQ2.2-FL02	1	One-way flow control valve	GRLA-1/4-QB-3/8-U		FES.534663
=V1UQ53UQ3-QN3	0	Solenoid valve	VSVA-B-B52-ZD-A1-1T1L	FES	FES.539156
=V1UQ53UQ3-UQ3.1-FL01	1	One-way flow control valve	GRLA-1/4-QB-3/8-U		FES.534663
=V1UQ53UQ3-UQ3.1-FL02	1	One-way flow control valve	GRLA-1/4-QB-3/8-U		FES.534663
=V1UQ53UQ4-QN4	0	Solenoid valve	VSVA-B-B52-ZD-A1-1T1L	FES	FES.539156
=V1UQ53UQ4-UQ4.1-FL01	1	One-way flow control valve	GRLA-1/4-QB-3/8-U		FES.534663
=V1UQ53UQ4-UQ4.1-FL02	1	One-way flow control valve	GRLA-1/4-QB-3/8-U		FES.534663
=V1UQ53UQ4-UQ4.2-FL01	1	One-way flow control valve	GRLA-1/4-QB-3/8-U		FES.534663
=V1UQ53UQ4-UQ4.2-FL02	1	One-way flow control valve	GRLA-1/4-QB-3/8-U		FES.534663
=V1UQ53UQ5-QN5	0	Solenoid valve	VSVA-B-P53ED-ZD-A1-1T1L		FES.560727
=V1UQ53UQ5-QN100	1	3/8" DUAL PO CHECK VALVE, IN-LINE W/MANUAL TRAPPED AIR RELIEF	2768D3904	ROSS CONTROLS	2768D3904
=V1UQ53UQ5-UQ5.1-FL01	1	One-way flow control valve	GRLA-1/4-QB-3/8-U		FES.534663
=V1UQ53UQ5-UQ5.1-FL02	1	One-way flow control valve	GRLA-1/4-QB-3/8-U		FES.534663
=V1UQ53UQ6-QN6	0	Solenoid valve	VSVA-B-B52-ZD-A1-1T1L	FES	FES.539156
=V1UQ53UQ6-UQ6.1-FL01	1	One-way flow control valve	GRLA-1/4-QB-3/8-U		FES.534663
=V1UQ53UQ6-UQ6.1-FL02	1	One-way flow control valve	GRLA-1/4-QB-3/8-U		FES.534663

+ .UQ52/1

+ .UQ54/1

Date	12/20/2022	Volvo Trucks North America	Valiant TMS	Parts list :	Drawing name:	=		
Ed.	MKLEPADLO	P6700 Underbody Mainline - Cell 2V04	Scale 1:1	FES.51E-F33GCQPNMKBNMKB-S-UL1+GS2GZBA & 45PN-R-Z-LSMX-3BU-4JSAJ - FES.534663	=2V04&MFS-PNEU	+ V1UQ53		
Appr							Document type:	Project nr:
Modification	Date	Name	Original	Replacement of	Replaced by	MPB	22-16151	1
								227





# Parts list

F01\_001

Device tag	Quantity	Designation	Type number	Supplier	Part number
=V1UQ55KF1-KF1.0	1	Valve Manifold	51E-F33GCQPNMKBNMKBNMK-B-S-UL1+GS2GZBA & 45PN-R-Z-LSMX-5BU-9JL	FES	FES.51E-F33GCQPNMKBNMKBNMK-B-S-UL1+GS2GZBA & 45PN-R-Z-LSMX-5BU-9JL
=V1UQ55KF1-KF1.21	0	Manifold subbase	VABV-S4-1HS-N14-2T2		FES.546213
=V1UQ55KF1-KF1.22	0	Manifold subbase	VABV-S4-1HS-N14-2T2		FES.546213
=V1UQ55KF1-KF1.23	0	Manifold subbase	VABV-S4-1HS-N14-2T2		FES.546213
=V1UQ55KF1-KF1.24	0	Manifold subbase	VABV-S4-1HS-N14-2T2		FES.546213
=V1UQ55KF1-KF1.25	0	Manifold subbase	VABV-S4-1HS-N14-2T2		FES.546213
=V1UQ55UQ1-QN1	0	Solenoid valve	VSVA-B-B52-ZD-A1-1T1L	FES	FES.539156
=V1UQ55UQ1-UQ1.1-FL01	1	One-way flow control valve	GRLA-1/4-QB-3/8-U		FES.534663
=V1UQ55UQ1-UQ1.1-FL02	1	One-way flow control valve	GRLA-1/4-QB-3/8-U		FES.534663
=V1UQ55UQ1-UQ1.2-FL01	1	One-way flow control valve	GRLA-1/4-QB-3/8-U		FES.534663
=V1UQ55UQ1-UQ1.2-FL02	1	One-way flow control valve	GRLA-1/4-QB-3/8-U		FES.534663
=V1UQ55UQ1-UQ1.3-FL01	1	One-way flow control valve	GRLA-1/4-QB-3/8-U		FES.534663
=V1UQ55UQ1-UQ1.3-FL02	1	One-way flow control valve	GRLA-1/4-QB-3/8-U		FES.534663
=V1UQ55UQ1-UQ1.4-FL01	1	One-way flow control valve	GRLA-1/4-QB-3/8-U		FES.534663
=V1UQ55UQ1-UQ1.4-FL02	1	One-way flow control valve	GRLA-1/4-QB-3/8-U		FES.534663
=V1UQ55UQ2-QN2	0	Solenoid valve	VSVA-B-B52-ZD-A1-1T1L	FES	FES.539156
=V1UQ55UQ2-UQ2.1-FL01	1	One-way flow control valve	GRLA-1/4-QB-3/8-U		FES.534663
=V1UQ55UQ2-UQ2.1-FL02	1	One-way flow control valve	GRLA-1/4-QB-3/8-U		FES.534663
=V1UQ55UQ2-UQ2.2-FL01	1	One-way flow control valve	GRLA-1/4-QB-3/8-U		FES.534663
=V1UQ55UQ2-UQ2.2-FL02	1	One-way flow control valve	GRLA-1/4-QB-3/8-U		FES.534663
=V1UQ55UQ3-QN3	0	Solenoid valve	VSVA-B-B52-ZD-A1-1T1L	FES	FES.539156
=V1UQ55UQ3-UQ3.1-FL01	1	One-way flow control valve	GRLA-1/4-QB-3/8-U		FES.534663
=V1UQ55UQ3-UQ3.1-FL02	1	One-way flow control valve	GRLA-1/4-QB-3/8-U		FES.534663
=V1UQ55UQ3-UQ3.2-FL01	1	One-way flow control valve	GRLA-1/4-QB-3/8-U		FES.534663
=V1UQ55UQ3-UQ3.2-FL02	1	One-way flow control valve	GRLA-1/4-QB-3/8-U		FES.534663
=V1UQ55UQ4-QN4	0	Solenoid valve	VSVA-B-B52-ZD-A1-1T1L	FES	FES.539156
=V1UQ55UQ4-UQ4.1-FL01	1	One-way flow control valve	GRLA-1/4-QB-3/8-U		FES.534663
=V1UQ55UQ4-UQ4.1-FL02	1	One-way flow control valve	GRLA-1/4-QB-3/8-U		FES.534663
=V1UQ55UQ4-UQ4.2-FL01	1	One-way flow control valve	GRLA-1/4-QB-3/8-U		FES.534663
=V1UQ55UQ4-UQ4.2-FL02	1	One-way flow control valve	GRLA-1/4-QB-3/8-U		FES.534663
=V1UQ55UQ5-QN5	0	Solenoid valve	VSVA-B-B52-ZD-A1-1T1L	FES	FES.539156
=V1UQ55UQ5-UQ5.1-FL01	1	One-way flow control valve	GRLA-1/4-QB-3/8-U		FES.534663
=V1UQ55UQ5-UQ5.1-FL02	1	One-way flow control valve	GRLA-1/4-QB-3/8-U		FES.534663
=V1UQ55UQ5-UQ5.2-FL01	1	One-way flow control valve	GRLA-1/4-QB-3/8-U		FES.534663
=V1UQ55UQ5-UQ5.2-FL02	1	One-way flow control valve	GRLA-1/4-QB-3/8-U		FES.534663
=V1UQ55UQ6-QN6	0	Solenoid valve	VSVA-B-B52-ZD-A1-1T1L	FES	FES.539156
=V1UQ55UQ6-UQ6.1-FL01	1	One-way flow control valve	GRLA-1/4-QB-3/8-U		FES.534663
=V1UQ55UQ6-UQ6.1-FL02	1	One-way flow control valve	GRLA-1/4-QB-3/8-U		FES.534663
=V1UQ55UQ6-UQ6.2-FL01	1	One-way flow control valve	GRLA-1/4-QB-3/8-U		FES.534663
=V1UQ55UQ6-UQ6.2-FL02	1	One-way flow control valve	GRLA-1/4-QB-3/8-U		FES.534663
=V1UQ55UQ7-QN7	0	Solenoid valve	VSVA-B-B52-ZD-A1-1T1L	FES	FES.539156
=V1UQ55UQ7-UQ7.1-FL01	1	One-way flow control valve	GRLA-1/4-QB-3/8-U		FES.534663
=V1UQ55UQ7-UQ7.1-FL02	1	One-way flow control valve	GRLA-1/4-QB-3/8-U		FES.534663
=V1UQ55UQ7-UQ7.2-FL01	1	One-way flow control valve	GRLA-1/4-QB-3/8-U		FES.534663
=V1UQ55UQ7-UQ7.2-FL02	1	One-way flow control valve	GRLA-1/4-QB-3/8-U		FES.534663
=V1UQ55UQ8-QN8	0	Solenoid valve	VSVA-B-B52-ZD-A1-1T1L	FES	FES.539156
=V1UQ55UQ8-UQ8.1-FL01	1	One-way flow control valve	GRLA-1/4-QB-3/8-U		FES.534663
=V1UQ55UQ8-UQ8.1-FL02	1	One-way flow control valve	GRLA-1/4-QB-3/8-U		FES.534663
=V1UQ55UQ8-UQ8.2-FL01	1	One-way flow control valve	GRLA-1/4-QB-3/8-U		FES.534663
=V1UQ55UQ8-UQ8.2-FL02	1	One-way flow control valve	GRLA-1/4-QB-3/8-U		FES.534663
=V1UQ55UQ9-QN9	0	Solenoid valve	VSVA-B-B52-ZD-A1-1T1L	FES	FES.539156
=V1UQ55UQ9-UQ9.1-FL01	1	One-way flow control valve	GRLA-1/4-QB-3/8-U		FES.534663
=V1UQ55UQ9-UQ9.1-FL02	1	One-way flow control valve	GRLA-1/4-QB-3/8-U		FES.534663
=V1UQ55UQ9-UQ9.2-FL01	1	One-way flow control valve	GRLA-1/4-QB-3/8-U		FES.534663
=V1UQ55UQ9-UQ9.2-FL02	1	One-way flow control valve	GRLA-1/4-QB-3/8-U		FES.534663
=V1UQ55UQ10-QN10	0	Blanking plate	VABB-S4-1-WT		FES.539212

+ .UQ54/1

+ .WR1UQ51/1

Date	12/20/2022	Volvo Trucks North America	Valiant TMS	Parts list :	Drawing name:	=	
Ed.	MKLEPADLO	P6700 Underbody Mainline - Cell 2V04	Scale 1:1	FES.51E-F33GCQPNMKBNMKBNMK-B-S-UL1+GS2GZBA & 45PN-R-Z-LSMX-5BU-9JL - FES.539212	= 2V04&MFS-PNEU	+ V1UQ55	
Appr							Document type:
Modification	Date	Name	Original	Replaced by	MPB	22-16151	1
							227









LATEST REVISION				
REV.	DATE	SIGN.	DRAWING NR:	SHEET NR:
1	2022-11-04	KMAFFRE	&MFS=V1AR12UQ41UQ9+V1AR12UQ41	1
1	2022-11-04	KMAFFRE	&MFS=V1AR13UQ41UQ1+V1AR13UQ41	1
1	2022-11-04	KMAFFRE	&MFS=V1AR13UQ41UQ2+V1AR13UQ41	1
1	2022-11-04	KMAFFRE	&MFS=V1AR13UQ41UQ3+V1AR13UQ41	1
1	2022-11-04	KMAFFRE	&MFS=V1AR13UQ41UQ4+V1AR13UQ41	1
1	2022-11-04	KMAFFRE	&MFS=V1AR13UQ41UQ5+V1AR13UQ41	1
1	2022-11-04	KMAFFRE	&MFS=V1AR13UQ41UQ6+V1AR13UQ41	1
1	2022-11-04	KMAFFRE	&MFS=V1AR13UQ41UQ7+V1AR13UQ41	1
1	2022-11-04	KMAFFRE	&MFS=V1AR13UQ41UQ8+V1AR13UQ41	1
1	2022-11-04	KMAFFRE	&MFS=V1AR13UQ41UQ9+V1AR13UQ41	1
1	2022-11-04	KMAFFRE	&MFS=V1AR14UQ41UQ1+V1AR14UQ41	1
1	2022-11-04	KMAFFRE	&MFS=V1AR14UQ41UQ2+V1AR14UQ41	1
1	2022-11-04	KMAFFRE	&MFS=V1AR14UQ41UQ3+V1AR14UQ41	1
1	2022-11-04	KMAFFRE	&MFS=V1AR14UQ41UQ4+V1AR14UQ41	1
1	2022-11-04	KMAFFRE	&MFS=V1AR14UQ41UQ5+V1AR14UQ41	1
1	2022-11-04	KMAFFRE	&MFS=V1AR14UQ41UQ6+V1AR14UQ41	1
1	2022-11-04	KMAFFRE	&MFS=V1AR14UQ41UQ7+V1AR14UQ41	1
1	2022-11-04	KMAFFRE	&MFS=V1AR14UQ41UQ8+V1AR14UQ41	1
1	2022-11-04	KMAFFRE	&MFS=V1AR14UQ41UQ9+V1AR14UQ41	1
1	2022-11-04	KMAFFRE	&MFS=V1AR14UQ41UQ10+V1AR14UQ41	1
1	2022-11-04	KMAFFRE	&MFS=V1AR15UQ41UQ1+V1AR15UQ41	1
1	2022-11-04	KMAFFRE	&MFS=V1AR15UQ41UQ2+V1AR15UQ41	1
1	2022-11-04	KMAFFRE	&MFS=V1AR15UQ41UQ3+V1AR15UQ41	1
1	2022-11-04	KMAFFRE	&MFS=V1AR15UQ41UQ4+V1AR15UQ41	1
1	2022-11-04	KMAFFRE	&MFS=V1AR15UQ41UQ5+V1AR15UQ41	1
1	2022-11-04	KMAFFRE	&MFS=V1AR15UQ41UQ6+V1AR15UQ41	1
1	2022-11-04	KMAFFRE	&MFS=V1AR15UQ41UQ7+V1AR15UQ41	1
1	2022-11-04	KMAFFRE	&MFS=V1AR15UQ41UQ8+V1AR15UQ41	1
1	2022-11-04	KMAFFRE	&MFS=V1AR15UQ41UQ9+V1AR15UQ41	1

LATEST REVISION

REV.	DATE	SIGN.	DRAWING NR:	SHEET NR:
2	2022-11-11	MKLEPADLO	&MFS=V1AR11UQ41KF1+V1AR11UQ41	11
2	2022-11-11	MKLEPADLO	&MFS=V1AR11UQ41KF2+V1AR11UQ41	11
2	2022-11-11	MKLEPADLO	&MFS=V1AR11UQ41KF3+V1AR11UQ41	11
2	2022-11-11	MKLEPADLO	&MFS=V1AR12UQ41KF1+V1AR12UQ41	11
2	2022-11-11	MKLEPADLO	&MFS=V1AR13UQ41KF1+V1AR13UQ41	11
2	2022-11-11	MKLEPADLO	&MFS=V1AR14UQ41KF1+V1AR14UQ41	11
2	2022-11-11	MKLEPADLO	&MFS=V1AR15UQ41KF1+V1AR15UQ41	11
2	2022-11-11	MKLEPADLO	&MFS=V1GL11UQ51KF2+V1GL11UQ51	5,11
2	2022-11-11	MKLEPADLO	&MFS=V1GL11UQ51UQ4+V1GL11UQ51	1
2	2022-11-11	MKLEPADLO	&MFS=V1GL11UQ51UQ5+V1GL11UQ51	1
2	2022-11-11	MKLEPADLO	&MFS=V1GL11UQ51UQ6+V1GL11UQ51	1
2	2022-11-11	MKLEPADLO	&MFS=V1GL11UQ51UQ7+V1GL11UQ51	1
2	2022-11-11	MKLEPADLO	&MFS=V1GL11UQ51UQ11+V1GL11UQ51	1
2	2022-11-11	MKLEPADLO	&MFS=V1GL11UQ51UQ12+V1GL11UQ51	1
2	2022-11-11	MKLEPADLO	&MFS=V1GL12UQ51KF2+V1GL12UQ51	5,11
2	2022-11-11	MKLEPADLO	&MFS=V1GL12UQ51UQ5+V1GL12UQ51	1
2	2022-11-11	MKLEPADLO	&MFS=V1GL12UQ51UQ6+V1GL12UQ51	1
2	2022-11-11	MKLEPADLO	&MFS=V1GL12UQ51UQ11+V1GL12UQ51	1
2	2022-11-11	MKLEPADLO	&MFS=V1GL12UQ51UQ12+V1GL12UQ51	1
2	2022-11-11	MKLEPADLO	&MFS=V1GL13UQ51KF1+V1GL13UQ51	5,11
2	2022-11-11	MKLEPADLO	&MFS=V1GL13UQ51UQ1+V1GL13UQ51	1
2	2022-11-11	MKLEPADLO	&MFS=V1GL13UQ51UQ2+V1GL13UQ51	1
2	2022-11-11	MKLEPADLO	&MFS=V1GL13UQ51UQ3+V1GL13UQ51	1
2	2022-11-11	MKLEPADLO	&MFS=V1GL13UQ51UQ7+V1GL13UQ51	1
2	2022-11-11	MKLEPADLO	&MFS=V1GL13UQ51UQ8+V1GL13UQ51	1
2	2022-11-11	MKLEPADLO	&MFS=V1GL13UQ51UQx+V1GL13UQ51	1

**LATEST REVISION**

REV.	DATE	SIGN.	DRAWING NR:	SHEET NR:
3	2022-12-20	MKLEPADLO	&MFS=V1GL11UQ51KF2+V1GL11UQ51	5,11
3	2022-12-20	MKLEPADLO	&MFS=V1GL11UQ51UQ2+V1GL11UQ51	1
3	2022-12-20	MKLEPADLO	&MFS=V1GL11UQ51UQ3+V1GL11UQ51	1
3	2022-12-20	MKLEPADLO	&MFS=V1GL11UQ51UQ4+V1GL11UQ51	1
3	2022-12-20	MKLEPADLO	&MFS=V1GL11UQ51UQ5+V1GL11UQ51	1
3	2022-12-20	MKLEPADLO	&MFS=V1GL11UQ51UQ6+V1GL11UQ51	1
3	2022-12-20	MKLEPADLO	&MFS=V1GL11UQ51UQ7+V1GL11UQ51	1
3	2022-12-20	MKLEPADLO	&MFS=V1GL11UQ51UQ8+V1GL11UQ51	1
3	2022-12-20	MKLEPADLO	&MFS=V1GL11UQ51UQ12+V1GL11UQ51	1