



# Table of contents

Column X: An automatically generated page was edited

F06\_001-Copy

Page	Page description	supplementary page field	Date	Edited by	X
&MAA/1	Title page / cover sheet		9/22/2022	MKLEPADLO	
&MAB/1	Table of contents		11/11/2022	KMAFFRE	
&MAB/1.a	Table of contents		11/11/2022	KMAFFRE	
&MFS=KH0+KH0/1	Incoming air supply		9/22/2022	MKLEPADLO	
&MFS=V1AR41UQ41KF1+V1AR41UQ41/1	AIR SUPPLY GRIPPER		11/11/2022	KMAFFRE	
&MFS=V1AR41UQ41KF1+V1AR41UQ41/5	AIR SUPPLY CONFIGURATION		9/22/2022	MKLEPADLO	
&MFS=V1AR41UQ41KF1+V1AR41UQ41/11	AIR SUPPLY		11/11/2022	KMAFFRE	
&MFS=V1AR41UQ41UQ1+V1AR41UQ41/1	Clamps 1		11/7/2022	KMAFFRE	
&MFS=V1AR41UQ41UQ2+V1AR41UQ41/1	Clamps 2		11/7/2022	KMAFFRE	
&MFS=V1AR42UQ41KF1+V1AR42UQ41/1	AIR SUPPLY GRIPPER		11/11/2022	KMAFFRE	
&MFS=V1AR42UQ41KF1+V1AR42UQ41/5	AIR SUPPLY CONFIGURATION		9/22/2022	MKLEPADLO	
&MFS=V1AR42UQ41KF1+V1AR42UQ41/11	AIR SUPPLY		11/11/2022	KMAFFRE	
&MFS=V1AR42UQ41UQ1+V1AR42UQ41/1	Clamp 1		11/7/2022	KMAFFRE	
&MFS=V1AR42UQ41UQ2+V1AR42UQ41/1	Clamps 2		11/7/2022	KMAFFRE	
&MFS=V1GM1+KH1/1	Incoming air supply (Lift Assist)		9/22/2022	MKLEPADLO	
&MFS=V1UQ51+KH1/1	Incoming air supply (Fixture)		9/22/2022	MKLEPADLO	
&MFS=V1UQ51KF1+V1UQ51/5	AIR SUPPLY CONFIGURATION		9/22/2022	MKLEPADLO	
&MFS=V1UQ51KF1+V1UQ51/11	AIR SUPPLY		9/22/2022	MKLEPADLO	
&MFS=V1UQ51UQ1+V1UQ51/1	Shot Pin 1		9/22/2022	MKLEPADLO	
&MFS=V1UQ51UQ2+V1UQ51/1	Clamps 2		9/22/2022	MKLEPADLO	
&MFS=V1UQ51UQ3+V1UQ51/1	Clamps 3		9/22/2022	MKLEPADLO	
&MFS=V1UQ51UQ4+V1UQ51/1	Spare		9/22/2022	MKLEPADLO	
&MFS=V1WR1+KH1/1	Incoming air supply (Turn Table)		9/22/2022	MKLEPADLO	
&MFS=V1WR1UQ51KF1+V1WR1UQ51/5	AIR SUPPLY CONFIGURATION		9/22/2022	MKLEPADLO	
&MFS=V1WR1UQ51KF1+V1WR1UQ51/11	AIR SUPPLY		9/22/2022	MKLEPADLO	
&MFS=V1WR1UQ51UQ1+V1WR1UQ51/1	Shot Pins 1		9/22/2022	MKLEPADLO	
&MFS=V1WR1UQ51UQ2+V1WR1UQ51/1	Shot Pin 2		9/22/2022	MKLEPADLO	
&MFS=V1WR1UQ51UQ3+V1WR1UQ51/1	Shot Pin 3		9/22/2022	MKLEPADLO	
&MFS=V1WR1UQ51UQ4+V1WR1UQ51/1	Clamps 4		9/22/2022	MKLEPADLO	
&MFS=V1WR1UQ51UQ5+V1WR1UQ51/1	Clamps 5		9/22/2022	MKLEPADLO	
&MFS=V1WR1UQ51UQ6+V1WR1UQ51/1	Clamp 6		9/22/2022	MKLEPADLO	
&MFS=V1WR1UQ52KF1+V1WR1UQ52/5	AIR SUPPLY CONFIGURATION		9/22/2022	MKLEPADLO	
&MFS=V1WR1UQ52KF1+V1WR1UQ52/11	AIR SUPPLY		9/22/2022	MKLEPADLO	

&MAA/1

1.a

			Date	11/11/2022	Volvo Trucks North America		Valiant Machine & Tool	Table of contents	Drawing name:	=				
			Ed.	KMAFFRE							=			
			Appr		P6700 Rear Wall Hdr & Door Ring RH Cell				Document type:	MAB	Project nr:	22-16145	Page	1
Modification	Date	Name	Original		Replacement of	Replaced by	Scale 1:1							57

# Table of contents

Column X: An automatically generated page was edited

F06\_001-Copy

Page	Page description	supplementary page field	Date	Edited by	X
&MFS=V1WR1UQ52KF2+V1WR1UQ52/5	AIR SUPPLY CONFIGURATION		9/22/2022	MKLEPADLO	
&MFS=V1WR1UQ52KF2+V1WR1UQ52/11	AIR SUPPLY		9/22/2022	MKLEPADLO	
&MFS=V1WR1UQ52UQ1+V1WR1UQ52/1	Shot Pins 1		9/22/2022	MKLEPADLO	
&MFS=V1WR1UQ52UQ2+V1WR1UQ52/1	Shot Pins 2		9/22/2022	MKLEPADLO	
&MFS=V1WR1UQ52UQ3+V1WR1UQ52/1	Clamps 3		9/22/2022	MKLEPADLO	
&MFS=V1WR1UQ52UQ4+V1WR1UQ52/1	Clamps 4		9/22/2022	MKLEPADLO	
&MFS=V1WR1UQ52UQ5+V1WR1UQ52/1	Clamps 5		9/22/2022	MKLEPADLO	
&MFS=V1WR1UQ52UQ6+V1WR1UQ52/1	Clamps 6		9/22/2022	MKLEPADLO	
&MFS=V1WR1UQ52UQ7+V1WR1UQ52/1	Clamps 7		9/22/2022	MKLEPADLO	
&MFS=V1WR1UQ52UQ8+V1WR1UQ52/1	Clamps 8		9/22/2022	MKLEPADLO	
&MFS=V1WR1UQ52UQ9+V1WR1UQ52/1	Clamps 9		9/22/2022	MKLEPADLO	
&MFS=V1WR1UQ52UQ10+V1WR1UQ52/1	Clamps 10		9/22/2022	MKLEPADLO	
&MFS=V1WR1UQ52UQ11+V1WR1UQ52/1	Clamps 11		9/22/2022	MKLEPADLO	
&MFS=V1WR1UQ52UQ12+V1WR1UQ52/1	Spare		9/22/2022	MKLEPADLO	
&MPB+KH0/1	Material specification		9/22/2022	MKLEPADLO	
&MPB+KH1/1	Material specification		9/22/2022	MKLEPADLO	
&MPB+V1AR41UQ41/1	Material specification		9/22/2022	MKLEPADLO	
&MPB+V1AR42UQ41/1	Material specification		9/22/2022	MKLEPADLO	
&MPB+V1UQ51/1	Material specification		9/22/2022	MKLEPADLO	
&MPB+V1WR1UQ51/1	Material specification		9/22/2022	MKLEPADLO	
&MPB+V1WR1UQ52/1	Material specification		9/22/2022	MKLEPADLO	
&MPB+V1WR1UQ52/1.a	Material specification		11/7/2022	KMAFFRE	
&MAZ/1	Amendment page		11/7/2022	KMAFFRE	
&MAZ/2	Amendment page		11/11/2022	KMAFFRE	

&MFS=KH0+KH0/1

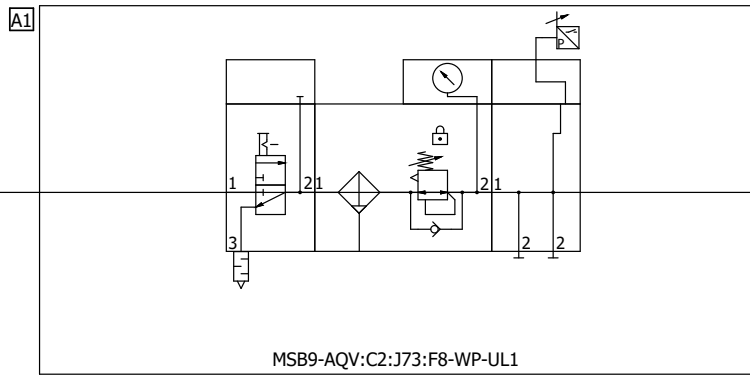

MSB9-AQV:C2:J73:F8-WP-UL1

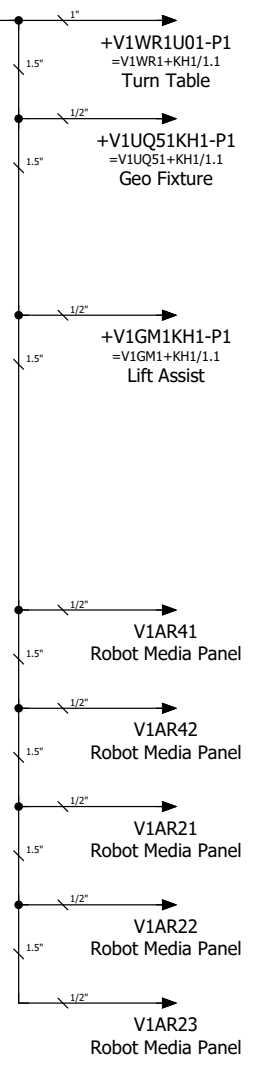

&MAB+/1.a

=V1AR41UQ41KF1+V1AR41UQ41/1

		Date	9/22/2022	Volvo Trucks North America		Valiant Machine & Tool Incoming air supply	Drawing name:		= KH0
		Ed.	MKLEPADLO	P6700 Rear Wall Hdr & Door Ring RH Cell			= 2V12&MFS-PNEU		+ KH0
Modification	Date	Name	Original	Replacement of	Replaced by	Scale 1:1	Document type:	Project nr:	Page
							MFS	22-16145	1 57



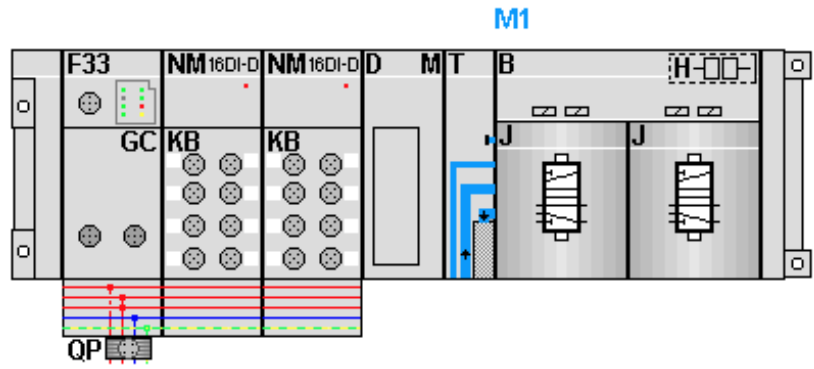

KF1.0

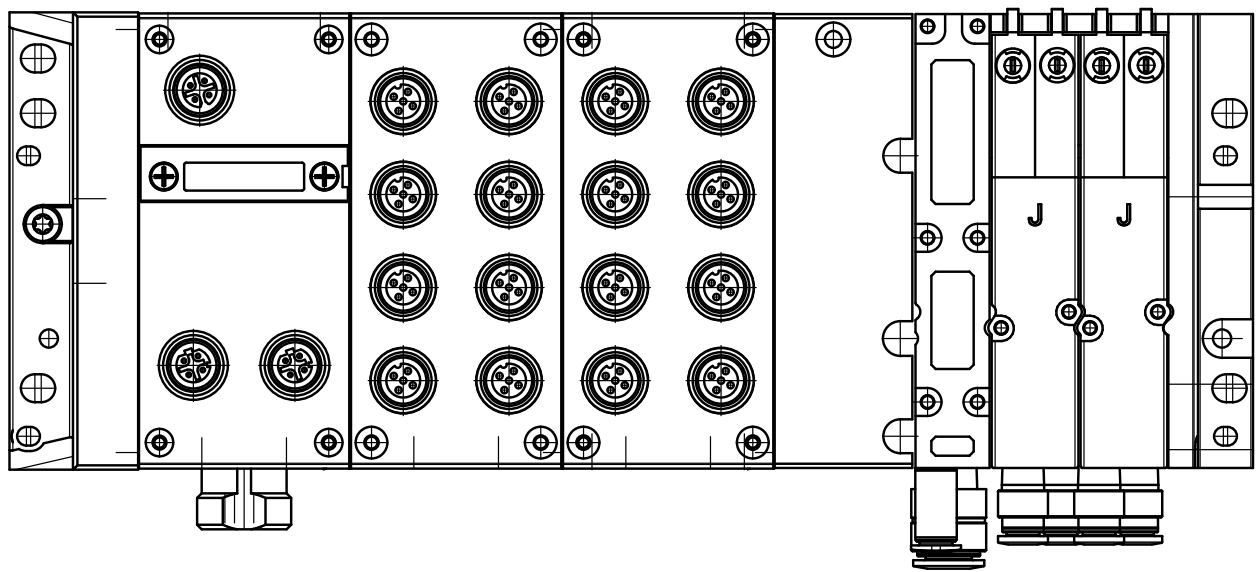

		Date	9/22/2022	Volvo Trucks North America	Valiant Machine & Tool	AIR SUPPLY CONFIGURATION	Drawing name:		= V1AR41UQ41KF1	Page	5
		Ed.	MKLEPADLO				Document type:		MFS		
		Appr		P6700 Rear Wall Hdr & Door Ring RH Cell	Scale 1:1	Document type:		MFS	Project nr:		22-16145
Modification	Date	Name	Original	Replacement of		Replaced by	Document type:		MFS	Project nr:	

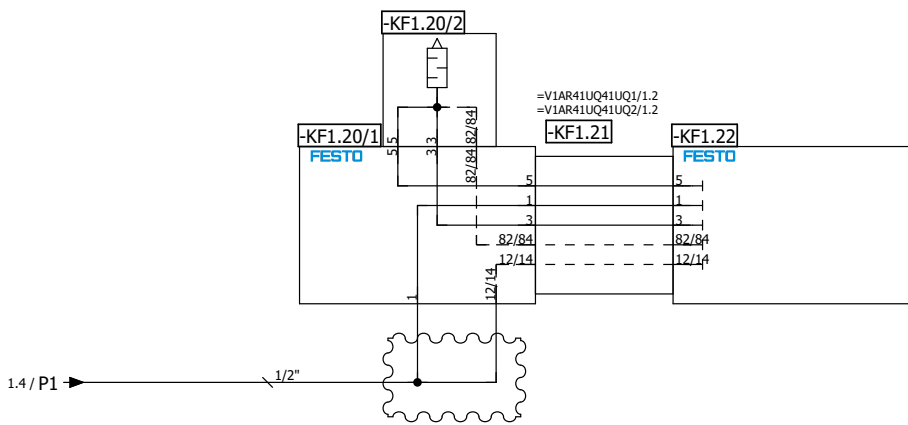
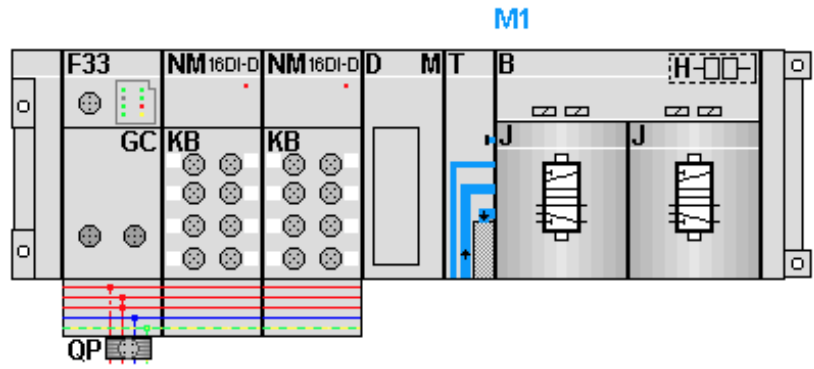

		Date	11/11/2022	Volvo Trucks North America		Valiant Machine & Tool	AIR SUPPLY	Drawing name:		= V1AR41UQ41KF1			
		Ed.	KMAFFRE					= 2V12&MFS-PNEU		+ V1AR41UQ41			
		Appr		P6700 Rear Wall Hdr & Door Ring RH Cell		Scale 1:1	Document type:		MFS	Project nr:	22-16145	Page	11
Modification	Date	Name	Original	Replacement of	Replaced by							Page	57

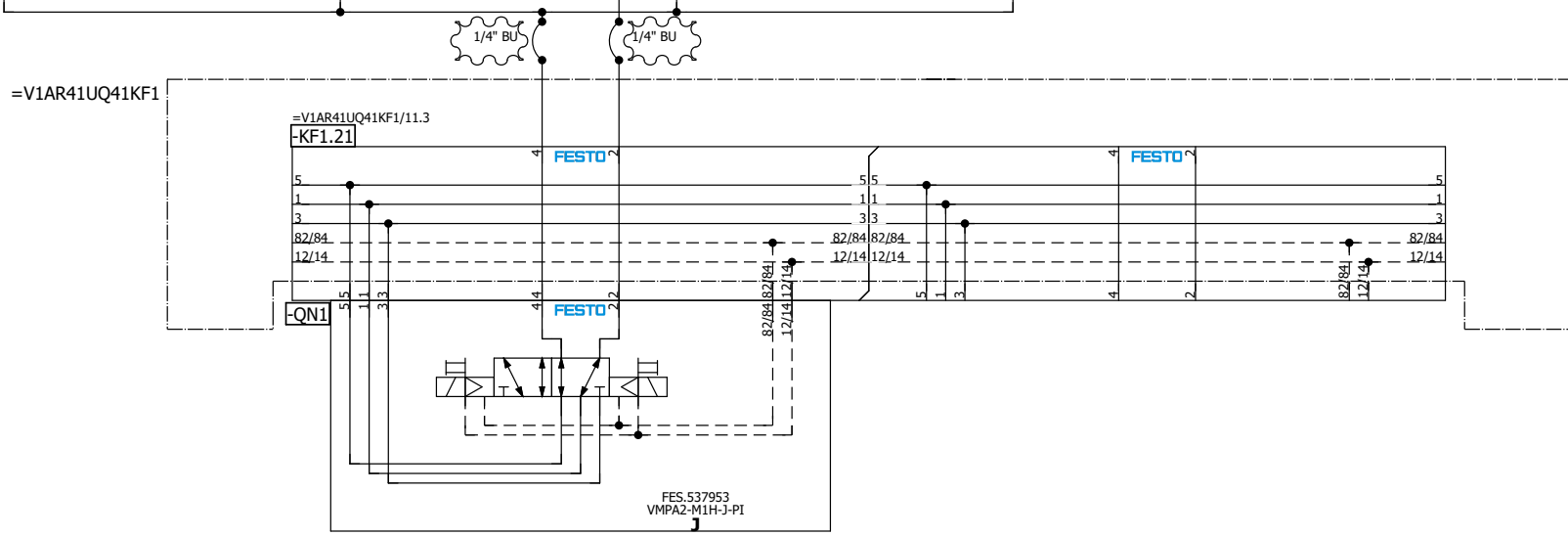
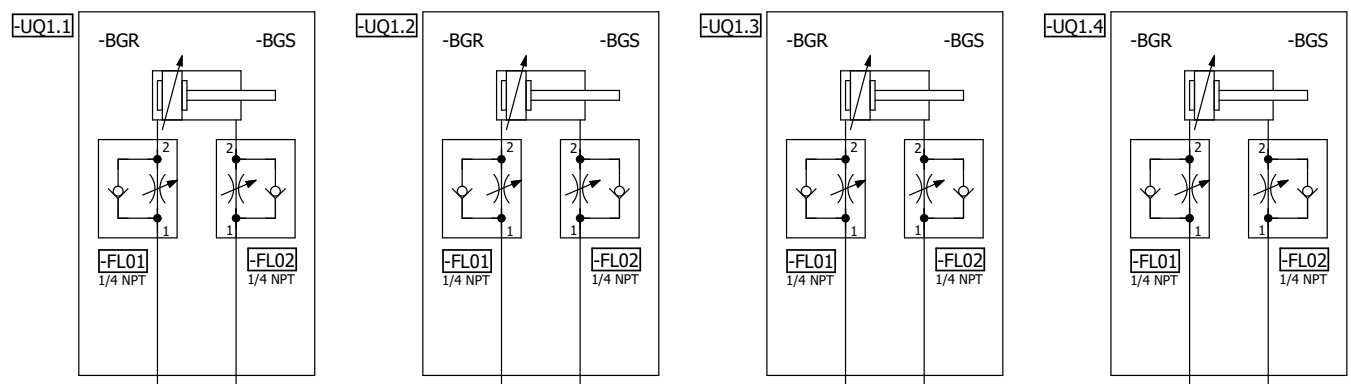

=V1AR41UQ41  
-UQ1-QN1.1  
Clamps 1  
(RST)

=V1AR41UQ41  
-UQ1-QN1.2  
Clamps 1  
(SET)

=V1AR41UQ41KF1/11

=V1AR41UQ41UQ2/1

Date	11/7/2022	Volvo Trucks North America	Valiant Machine & Tool	Clamps 1	Drawing name:	= 2V12&MFS-PNEU	= V1AR41UQ41UQ1
Ed.	KMAFFRE				Document type:	MFS	+ V1AR41UQ41
Appr		P6700 Rear Wall Hdr & Door Ring RH Cell	Scale 1:1		Project nr:	22-16145	Page 1
Modification	Date	Name	Original	Replacement of	Replaced by		57





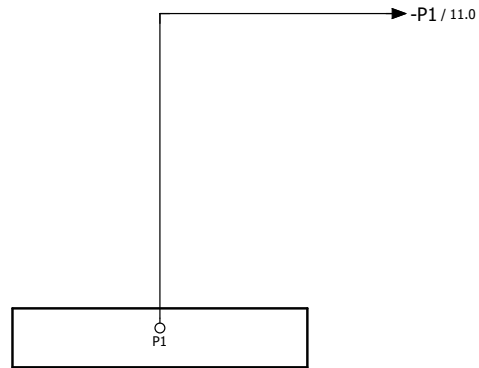

=V1AR41UQ41UQ2+.AR41UQ41/1

			Date	11/11/2022	Volvo Trucks North America		Valiant Machine & Tool	AIR SUPPLY GRIPPER	Drawing name:		= V1AR42UQ41KF1
			Ed.	KMAFFRE							= 2V12&MFS-PNEU
			Appr		P6700 Rear Wall Hdr & Door Ring RH Cell				Document type:	Project nr:	Page
Modification	Date	Name	Original		Replacement of	Replaced by	Scale 1:1		MFS	22-16145	57

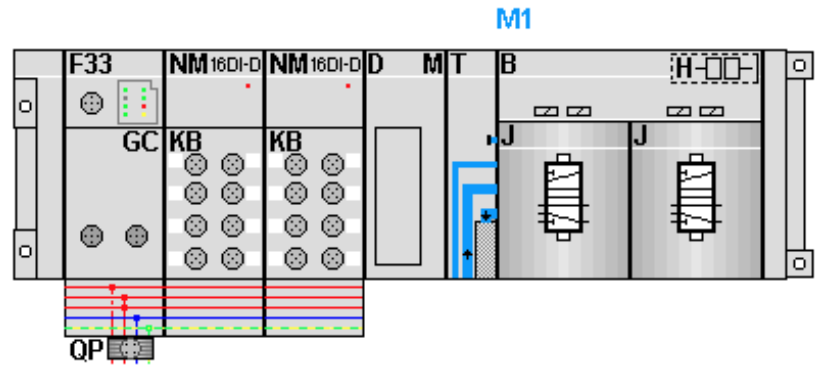

KF1.0

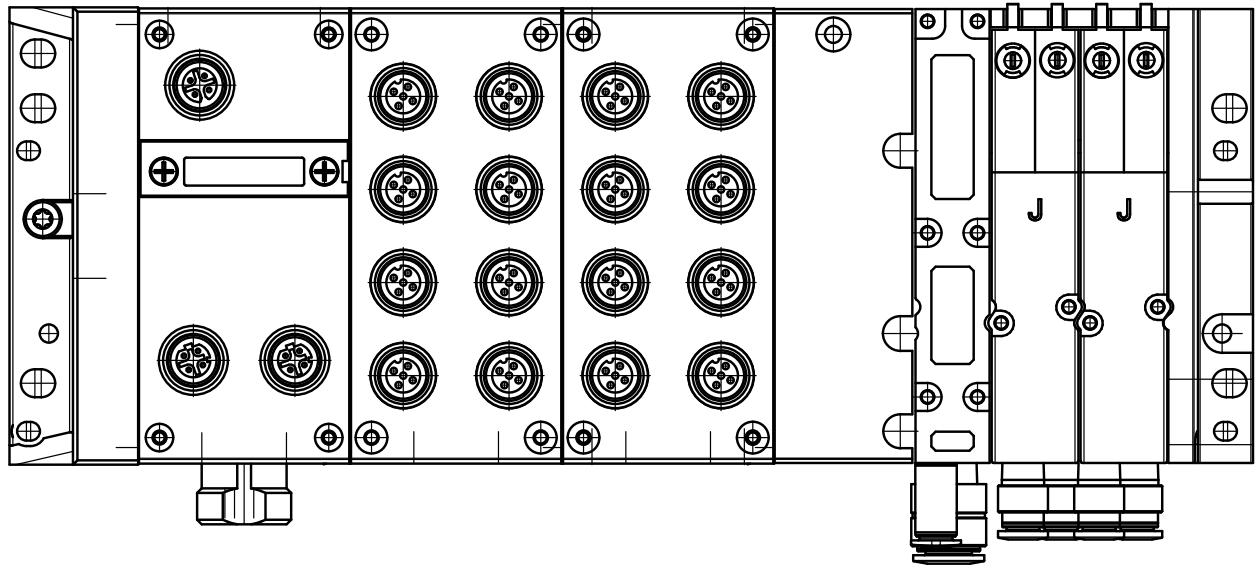

		Date	9/22/2022	Volvo Trucks North America	Valiant Machine & Tool	AIR SUPPLY CONFIGURATION	Drawing name:		= V1AR42UQ41KF1
		Ed.	MKLEPADLO				= 2V12&MFS-PNEU		+ V1AR42UQ41
		Appr		P6700 Rear Wall Hdr & Door Ring RH Cell	Scale 1:1		Document type:	Project nr:	Page
Modification	Date	Name	Original	Replacement of			Replaced by	MFS	22-16145

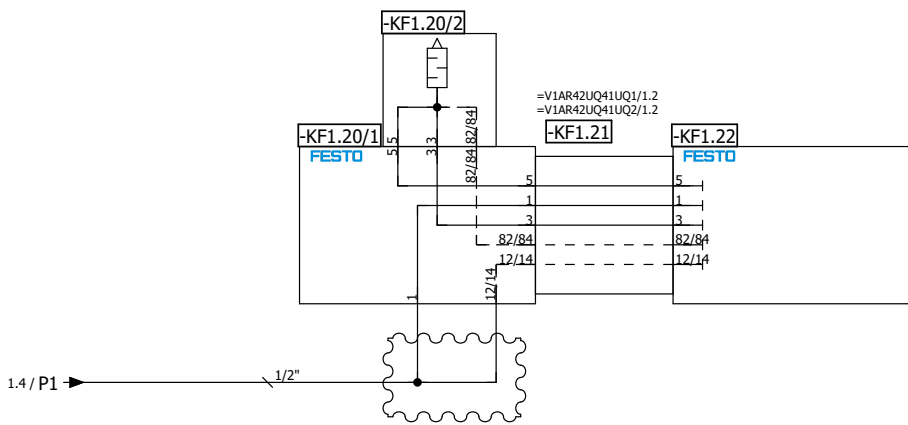
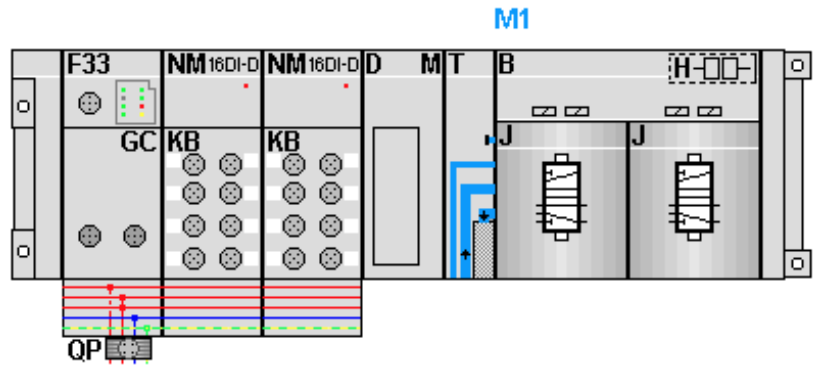

5

=V1AR42UQ41UQ1/1

		Date	11/11/2022	Volvo Trucks North America		 Valiant Machine & Tool AIR SUPPLY	Drawing name: =2V12&MFS-PNEU		= V1AR42UQ41KF1 + V1AR42UQ41		
		Ed.	KMAFFRE	P6700 Rear Wall Hdr & Door Ring RH Cell			Document type:	MFS	Project nr:	22-16145	Page
Modification	Date	Name	Original	Replacement of	Replaced by	Scale 1:1					57

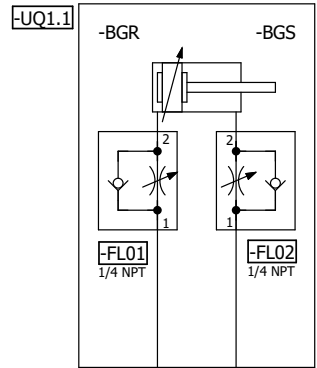

=V1AR42UQ41KF1

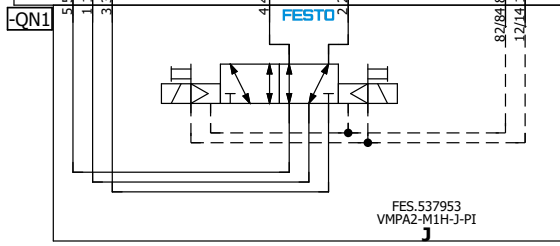
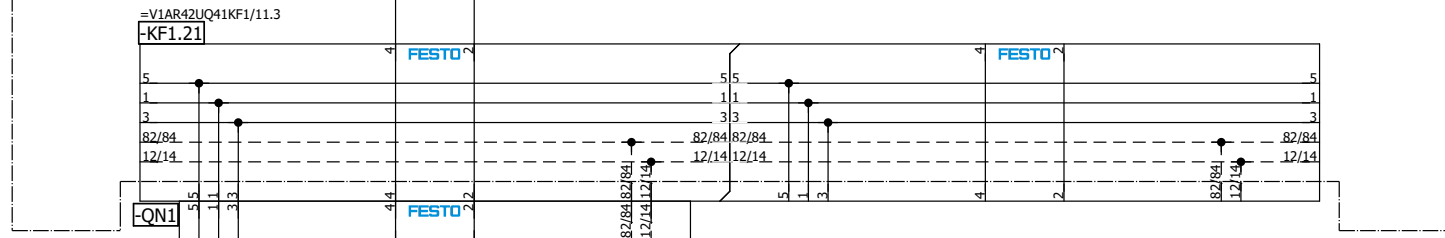

=V1AR42UQ41  
-UQ1-QN1.1  
Clamp 1  
(RST)

=V1AR42UQ41  
-UQ1-QN1.2  
Clamp 1  
(SET)

=V1AR42UQ41KF1/11

=V1AR42UQ41UQ2/1

Date	11/7/2022	Volvo Trucks North America	Valiant Machine & Tool	Clamp 1	Drawing name:	= 2V12&MFS-PNEU	= V1AR42UQ41UQ1
Ed.	KMAFFRE				Document type:	MFS	+ V1AR42UQ41
Appr		P6700 Rear Wall Hdr & Door Ring RH Cell	Scale 1:1		Project nr:	22-16145	Page 1
Modification	Date	Name	Original	Replacement of	Replaced by		57

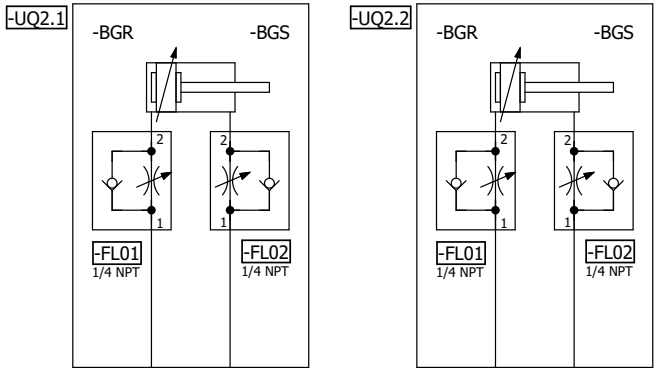

=V1AR42UQ41KF1

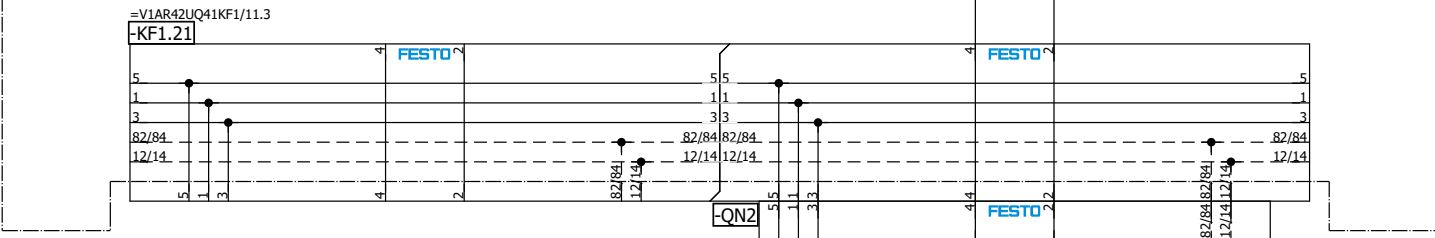

=V1AR42UQ41  
-UQ2-QN2.1  
Clamps 2  
(RST)

=V1AR42UQ41  
-UQ2-QN2.2  
Clamps 2  
(SET)

FES.537953  
VMPA2-M1H-J-PI

=V1GM1+KH1/1

			Date	11/7/2022	Volvo Trucks North America		Valiant Machine & Tool	Clamps 2	Drawing name:		= V1AR42UQ41UQ2	
			Ed.	KMAFFRE					= 2V12&MFS-PNEU		+ V1AR42UQ41	
			Appr		P6700 Rear Wall Hdr & Door Ring RH Cell		Scale 1:1	Document type:		MFS	Project nr: 22-16145	Page 1
Modification	Date	Name	Original		Replacement of	Replaced by		=V1GM1+KH1/1				







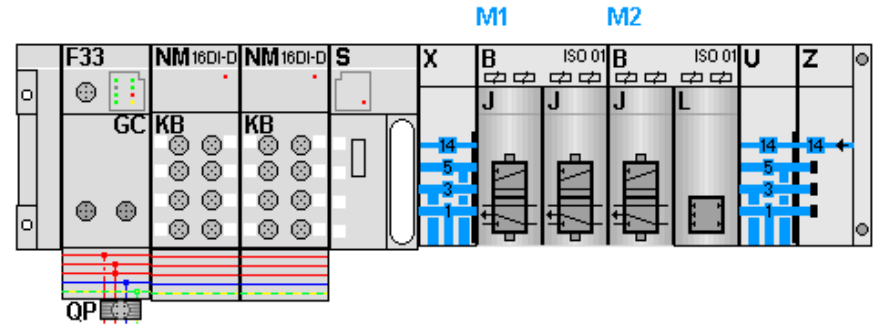

KF1.0

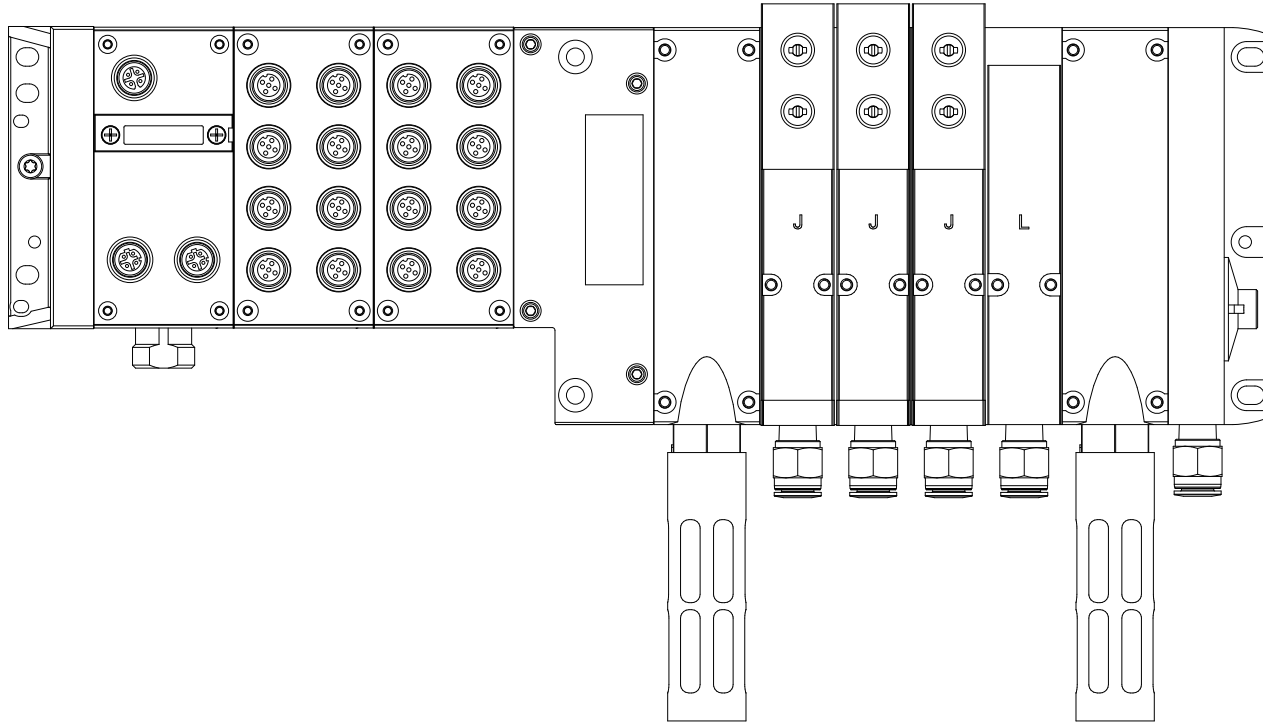

=V1UQ51+KH1/1

		Date	9/22/2022	Volvo Trucks North America		Valiant Machine & Tool	AIR SUPPLY CONFIGURATION		Drawing name: =2V12&MFS-PNEU		= V1UQ51KF1 + V1UQ51	
		Ed.	MKLEPADLO				Scale 1:1		Document type: MFS		Project nr: 22-16145	
Modification	Date	Name	Original	Replacement of	Replaced by							57



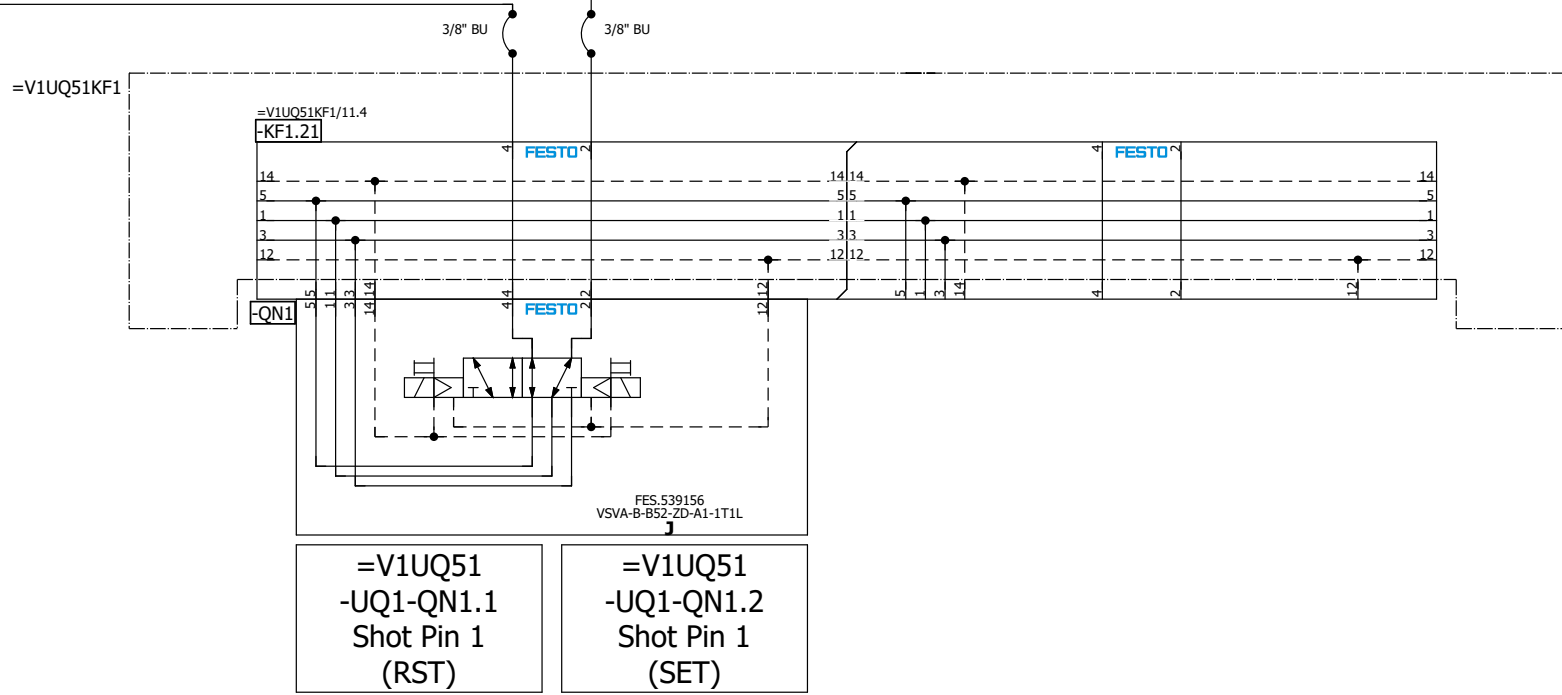
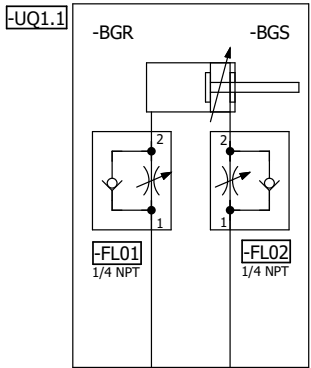

=V1UQ51KF1/11

=V1UQ51UQ2/1

		Date	9/22/2022	Volvo Trucks North America		Valiant Machine & Tool		Shot Pin 1		Drawing name: =2V12&MFS-PNEU		= V1UQ51UQ1 + V1UQ51	
		Ed.	MKLEPADLO			Scale 1:1				Document type: MFS		Project nr: 22-16145	
Modification	Date	Name	Original	Replacement of		Replaced by						Page	1
													57



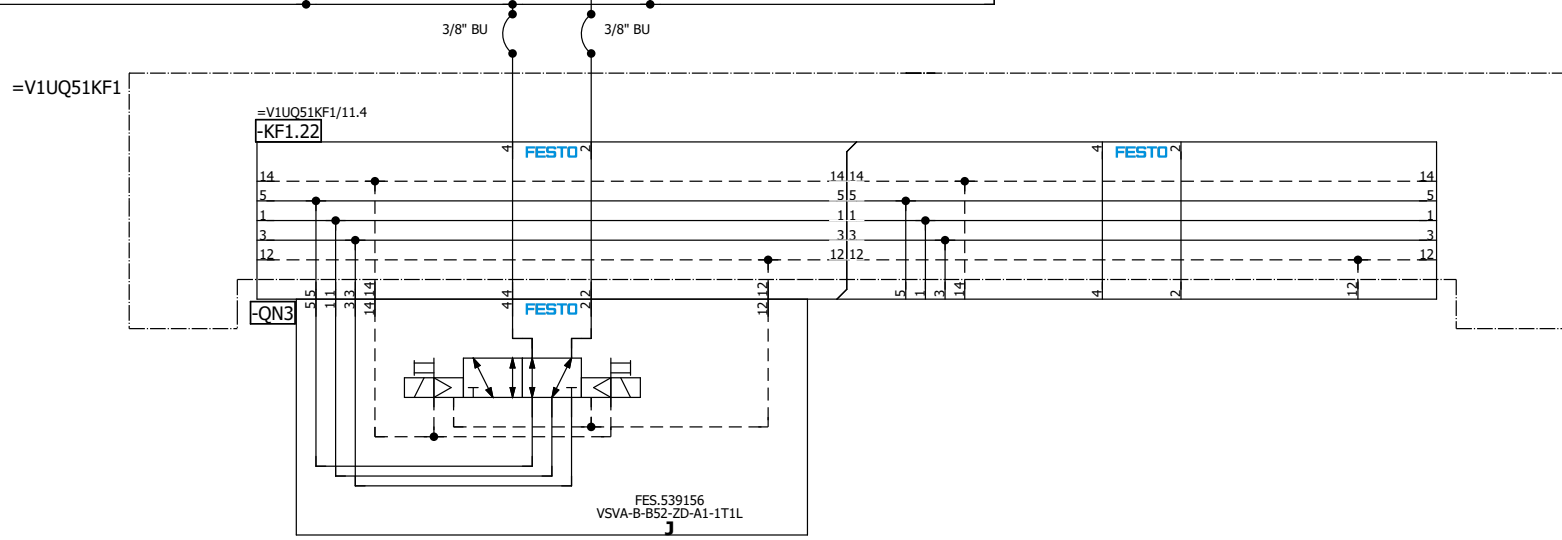
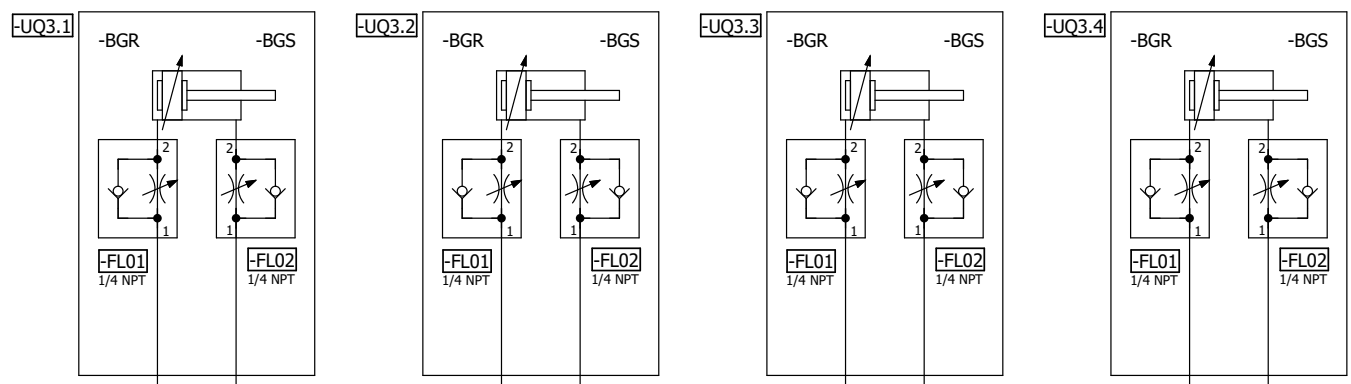

=V1UQ51  
-UQ3-QN3.1  
Clamps 3  
(RST)

=V1UQ51  
-UQ3-QN3.2  
Clamps 3  
(SET)

=V1UQ51UQ2/1 =V1UQ51UQ4/1

Date	9/22/2022	Volvo Trucks North America	Valiant Machine & Tool	Clamps 3	Drawing name:	=V1UQ51UQ3
Ed.	MKLEPADLO				=2V12&MFS-PNEU	+ V1UQ51
Appr		P6700 Rear Wall Hdr & Door Ring RH Cell	Scale 1:1		Document type:	Project nr:
Modification	Date	Name	Replacement of	Replaced by	MFS	22-16145
						Page 1
						57



A2

=KH0+KH0/1.7 / +V1WR1U01-P1

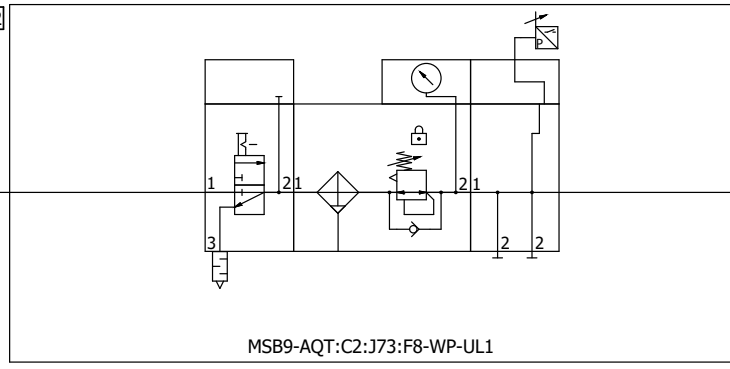

MSB9-AQT:C2:J73:F8-WP-UL1

1"

Turn table slip ring

1/2"

+V1WR1UQ51-P1 / =V1WR1UQ51KF1+V1WR1UQ51/11.0

1/2"

+V1WR1UQ52-P1 / =V1WR1UQ52KF1+V1WR1UQ52/11.1

=V1UQ51UQ4+V1UQ51/1

=V1WR1UQ51KF1+V1WR1UQ51/5

			Date	9/22/2022	Volvo Trucks North America		 Valiant Machine & Tool Incoming air supply (Turn Table)	Drawing name:		= V1WR1
			Ed.	MKLEPADLO	P6700 Rear Wall Hdr & Door Ring RH Cell			= 2V12&MFS-PNEU		+ KH1
			Appr		Replacement of		Scale 1:1	Document type:	Project nr:	Page
Modification	Date	Name	Original		Replaced by			MFS	22-16145	1
										57

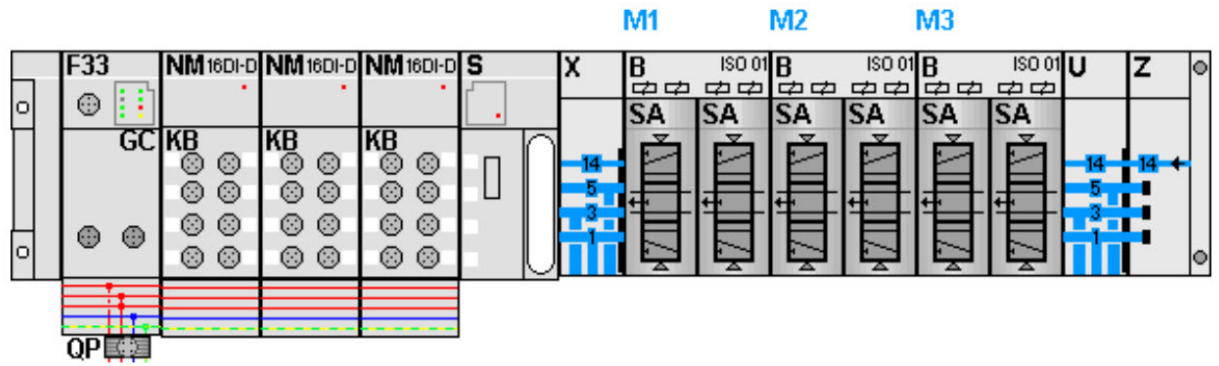

KF1.0

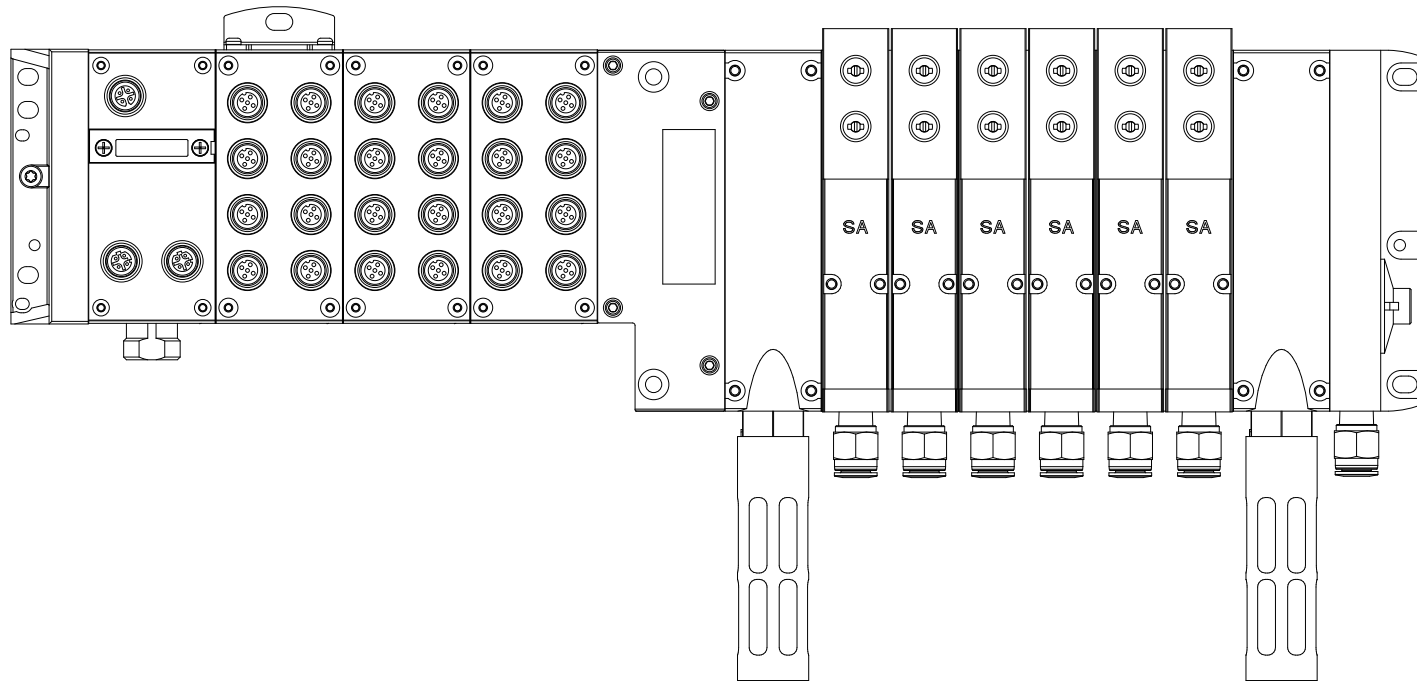

=V1WR1+KH1/1

		Date	9/22/2022	Volvo Trucks North America		Valiant Machine & Tool	AIR SUPPLY CONFIGURATION		Drawing name: = 2V12&MFS-PNEU		= V1WR1UQ51KF1 + V1WR1UQ51	
		Ed.	MKLEPADLO	P6700 Rear Wall Hdr & Door Ring RH Cell			Scale 1:1			Document type: MFS		Project nr: 22-16145
Modification	Date	Name	Original	Replacement of	Replaced by					Page	57	



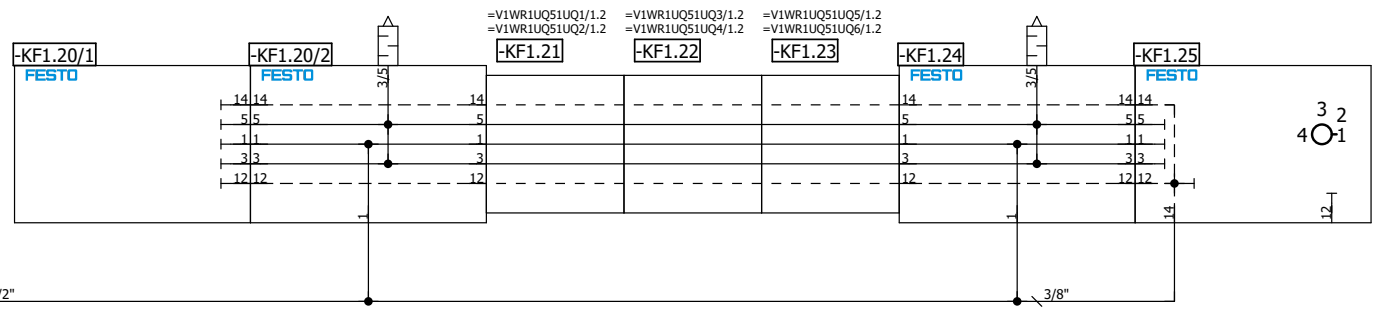
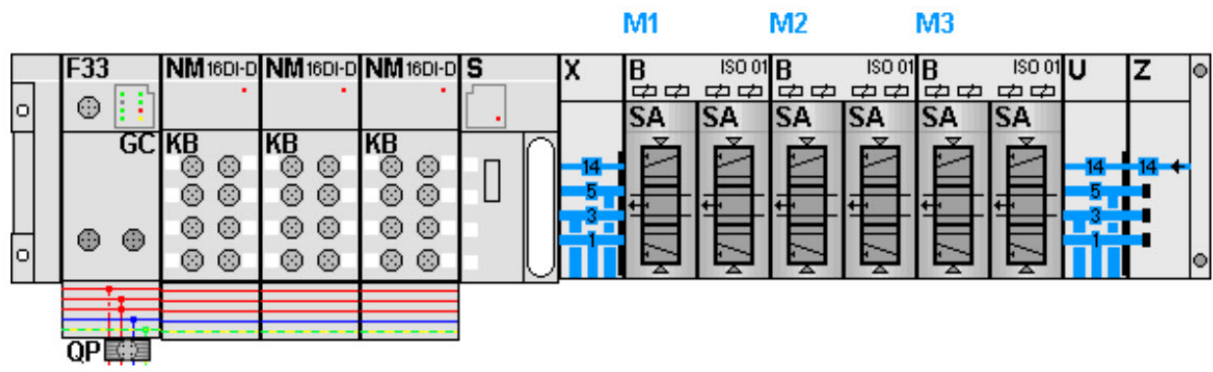

5

=V1WR1UQ51UQ1/1

Date		9/22/2022		Volvo Trucks North America		Valiant Machine & Tool		AIR SUPPLY		Drawing name:		= V1WR1UQ51KF1	
Ed.		MKLEPADLO		P6700 Rear Wall Hdr & Door Ring RH Cell		Scale 1:1				= 2V12&MFS-PNEU		+ V1WR1UQ51	
Appr				Replacement of		Replaced by				Document type:		Project nr:	
Modification		Date		Name		Original				MFS		22-16145	
											Page	11	
											Page	57	

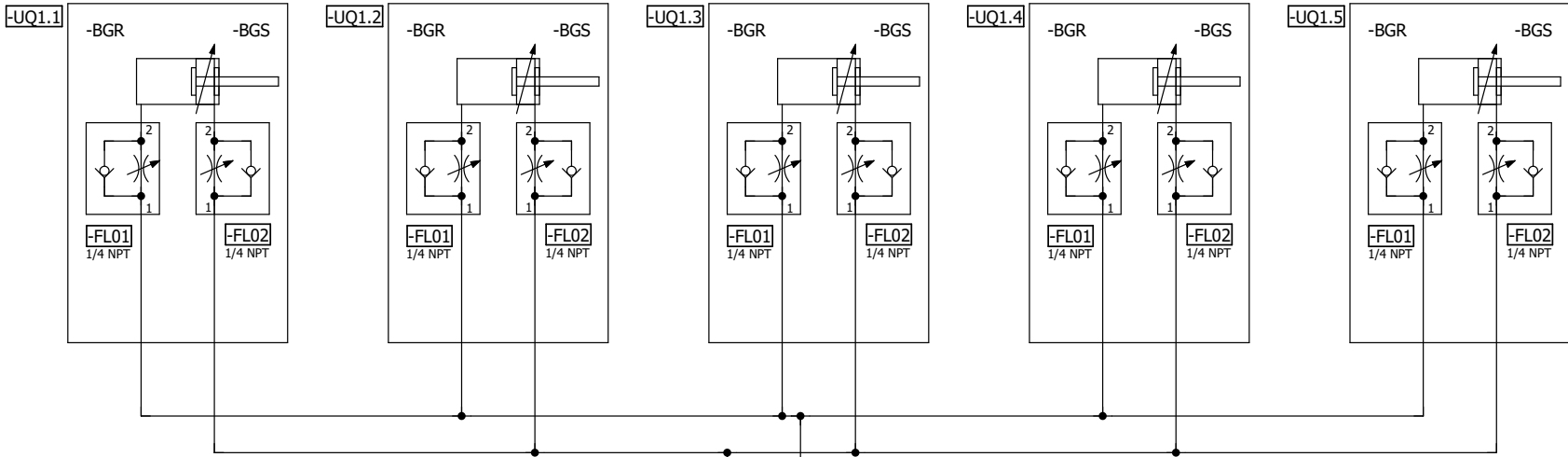

=V1WR1UQ51KF1

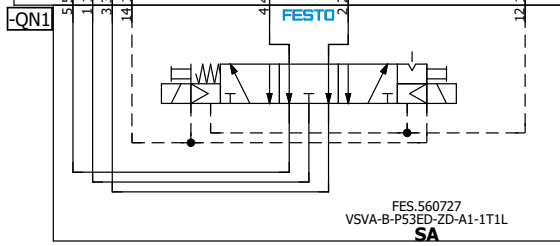
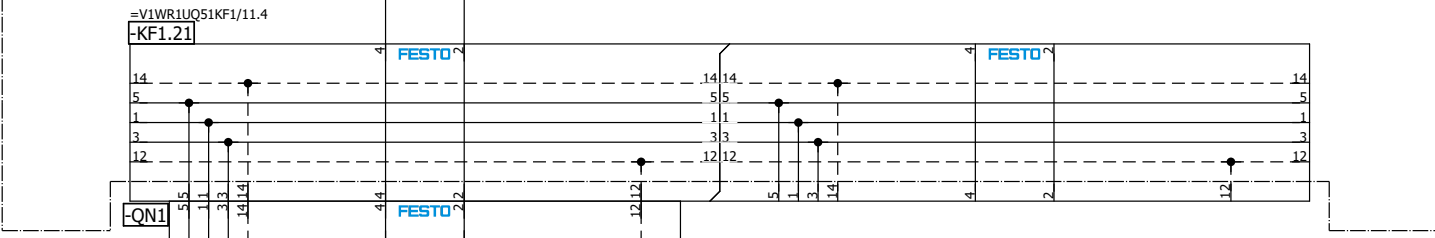

=V1WR1UQ51  
-UQ1-QN1.1  
Shot Pins 1  
(RST)

=V1WR1UQ51  
-UQ1-QN1.2  
Shot Pins 1  
(SET)

=V1WR1UQ51UQ2/1

		Date	9/22/2022	Volvo Trucks North America	Valiant Machine & Tool	Shot Pins 1	Drawing name:		= V1WR1UQ51UQ1
		Ed.	MKLEPADLO				= 2V12&MFS-PNEU		+ V1WR1UQ51
		Appr		P6700 Rear Wall Hdr & Door Ring RH Cell	Scale 1:1		Document type:	Project nr:	Page
Modification	Date	Name	Original	Replacement of			Replaced by	MFS	22-16145
									57

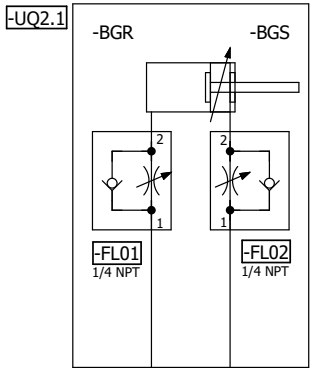

=V1WR1UQ51KF1

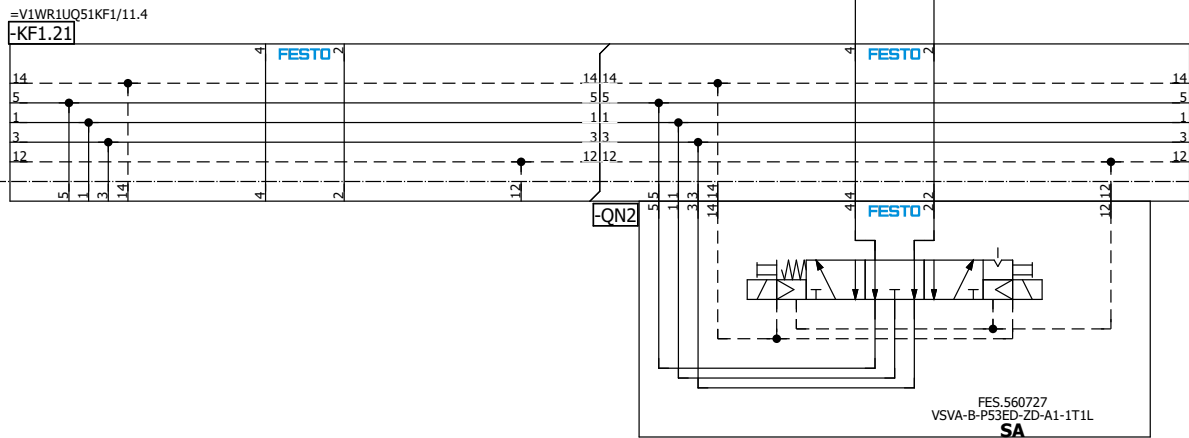

=V1WR1UQ51  
-UQ2-QN2.1  
Shot Pin 2  
(RST)

=V1WR1UQ51  
-UQ2-QN2.2  
Shot Pin 2  
(SET)

=V1WR1UQ51UQ3/1

			Date	9/22/2022	Volvo Trucks North America	Valiant Machine & Tool	Shot Pin 2	Drawing name:		= V1WR1UQ51UQ2
			Ed.	MKLEPADLO				= 2V12&MFS-PNEU		+ V1WR1UQ51
			Appr		P6700 Rear Wall Hdr & Door Ring RH Cell	Scale 1:1		Document type:	Project nr:	Page
Modification	Date	Name	Original		Replacement of			Replaced by	MFS	22-16145



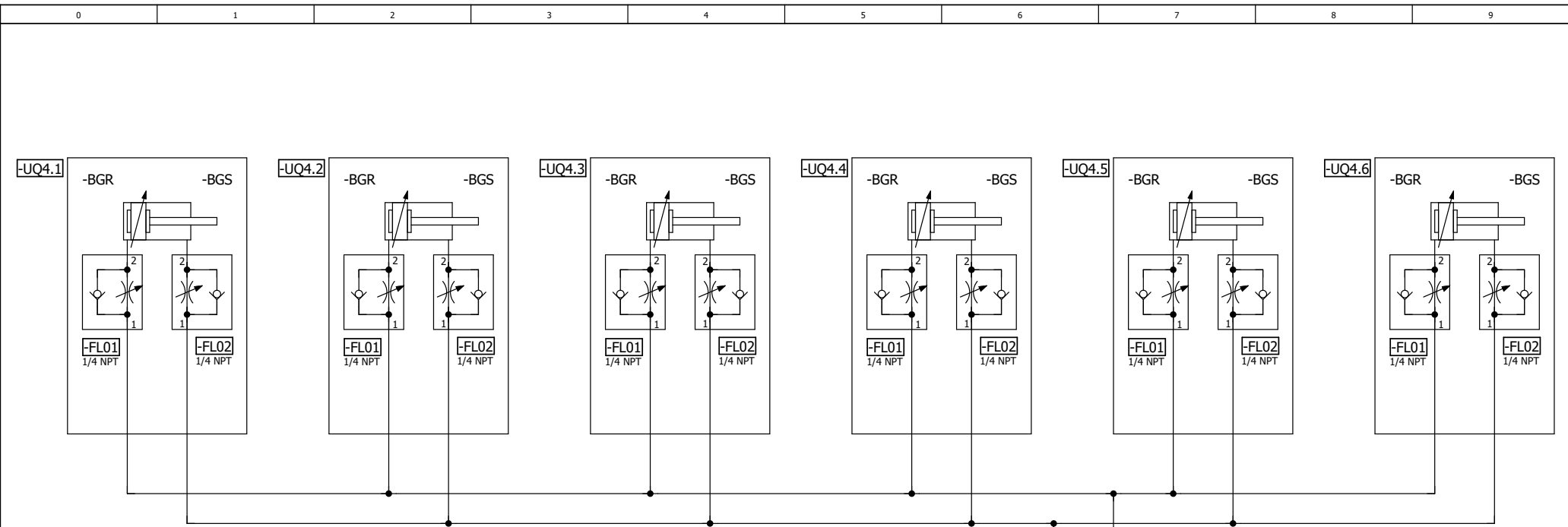

=V1WR1UQ51KF1

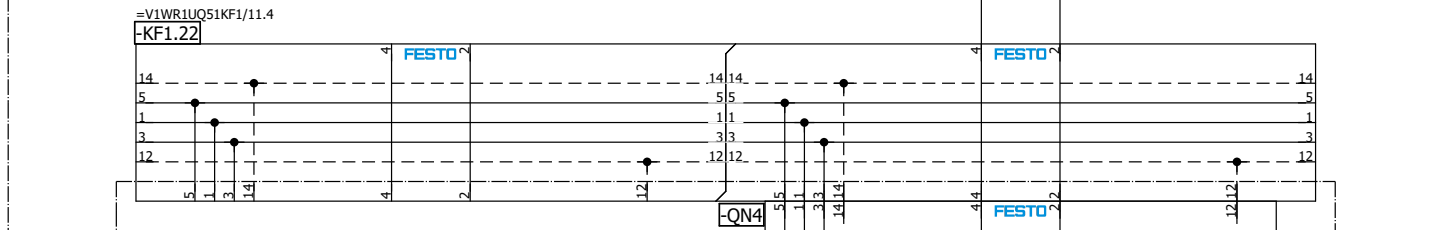

-QN4

FES 560727  
VSVA-B-P53ED-ZD-A1-1T1L  
SA

=V1WR1UQ51  
-UQ4-QN4.1  
Clamps 4  
(RST)

=V1WR1UQ51  
-UQ4-QN4.2  
Clamps 4  
(SET)

=V1WR1UQ51UQ5/1

			Date	9/22/2022	Volvo Trucks North America	Valiant Machine & Tool	Clamps 4	Drawing name:		= V1WR1UQ51UQ4		
			Ed.	MKLEPADLO				= 2V12&MFS-PNEU		+ V1WR1UQ51		
			Appr		P6700 Rear Wall Hdr & Door Ring RH Cell	Scale 1:1	Document type:		MFS	Project nr: 22-16145	Page	1
Modification	Date	Name	Original		Replacement of		Replaced by					

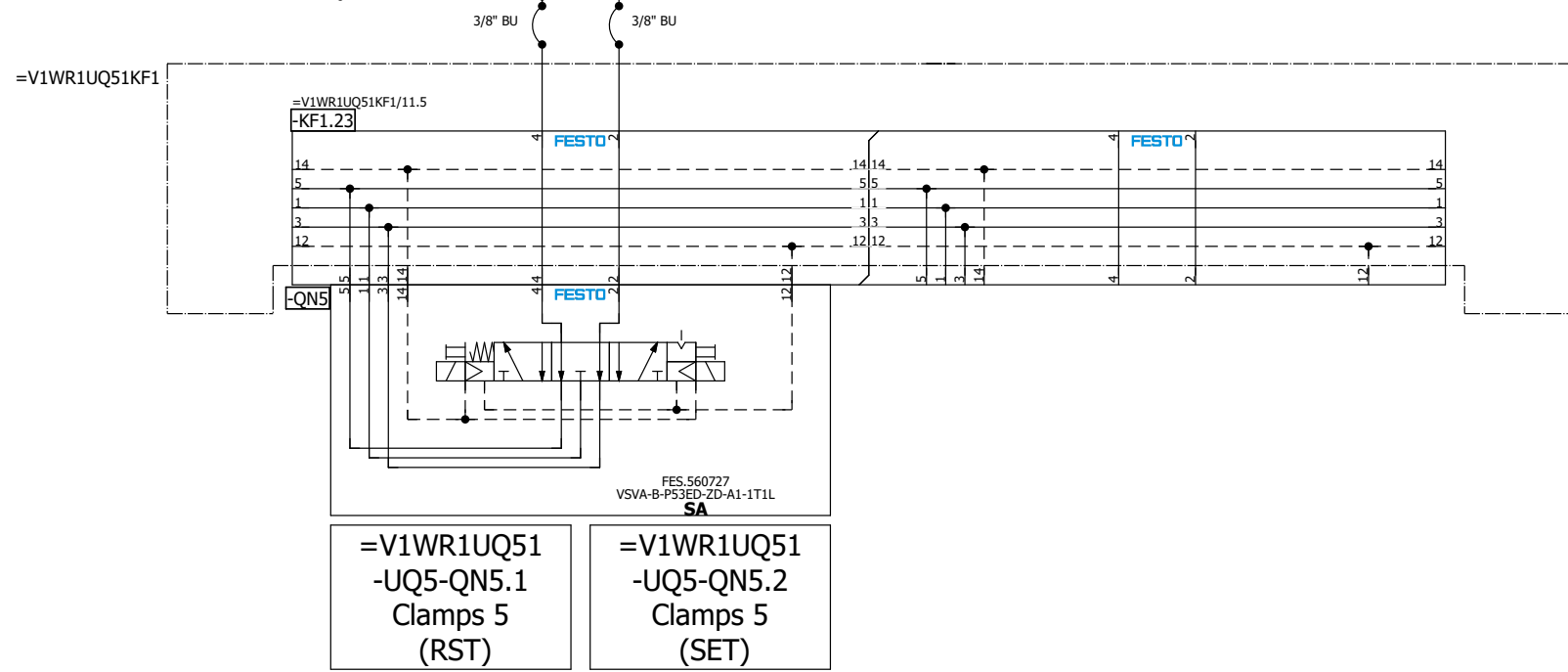
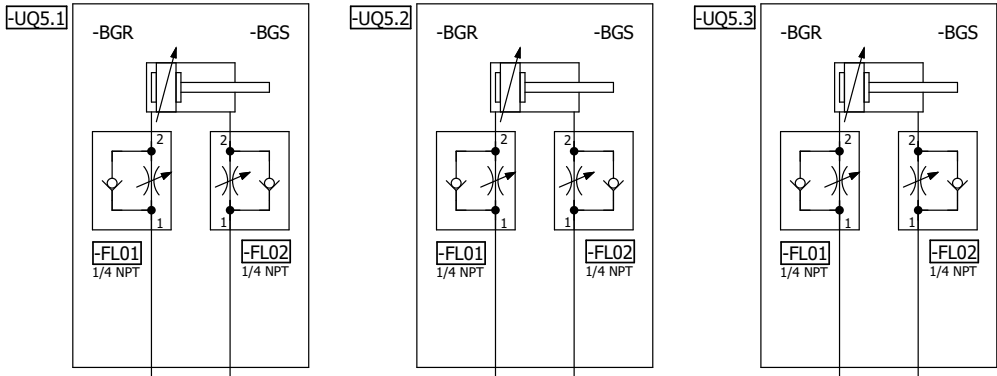

=V1WR1UQ51UQ4/1 =V1WR1UQ51UQ6/1

			Date 9/22/2022	Volvo Trucks North America		Valiant Machine & Tool	Clamps 5	Drawing name: =2V12&MFS-PNEU	= V1WR1UQ51UQ5 + V1WR1UQ51
			Ed. MKLEPADLO	P6700 Rear Wall Hdr & Door Ring RH Cell		Scale 1:1		Document type: MFS	Project nr: 22-16145
Modification	Date	Name	Original	Replacement of	Replaced by				Page 57

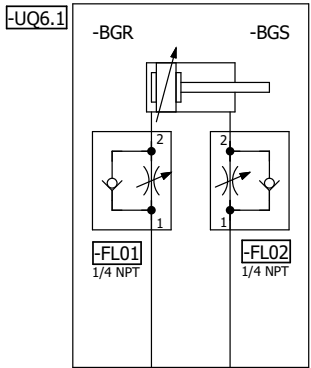

=V1WR1UQ51KF1

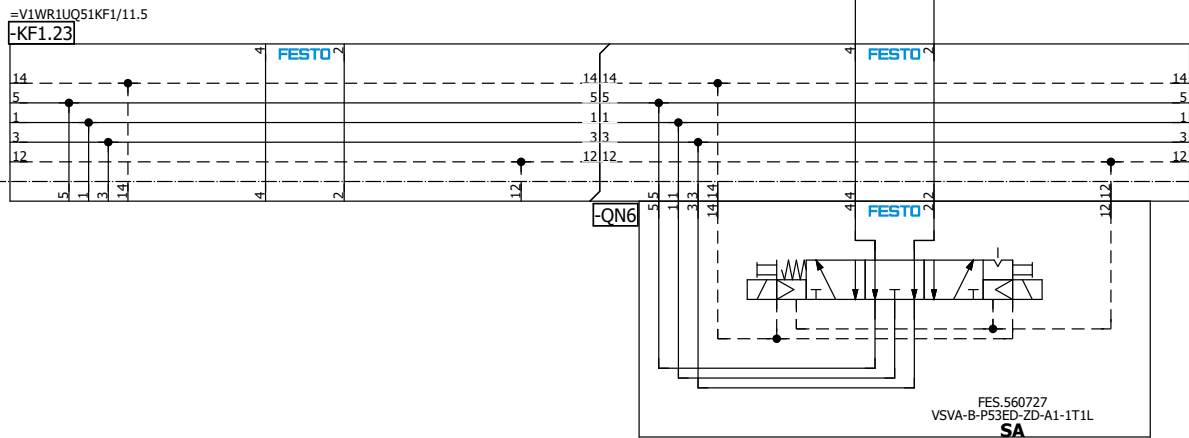

=V1WR1UQ51  
-UQ6-QN6.1  
Clamp 6  
(RST)

=V1WR1UQ51  
-UQ6-QN6.2  
Clamp 6  
(SET)

=V1WR1UQ52KF1+.WR1UQ52/5

=V1WR1UQ51UQ5/1			Date	9/22/2022	Volvo Trucks North America	Valiant Machine & Tool	Clamp 6	Drawing name:		= V1WR1UQ51UQ6				
			Ed.	MKLEPADLO				= 2V12&MFS-PNEU		+ V1WR1UQ51				
			Appr		P6700 Rear Wall Hdr & Door Ring RH Cell	Scale 1:1	Document type:		MFS	Project nr:		22-16145	Page	1
Modification	Date	Name	Original		Replacement of		Replaced by							







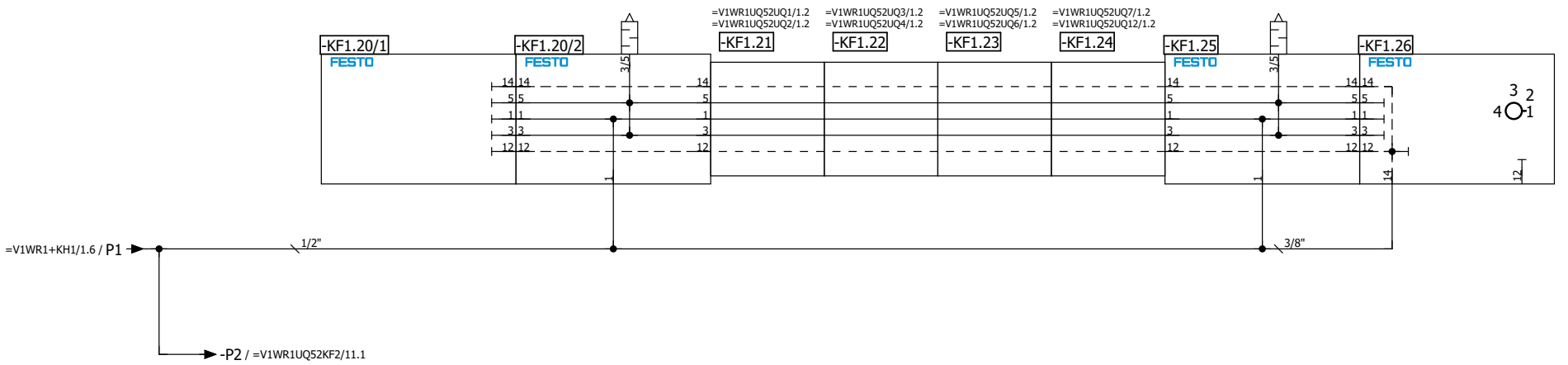
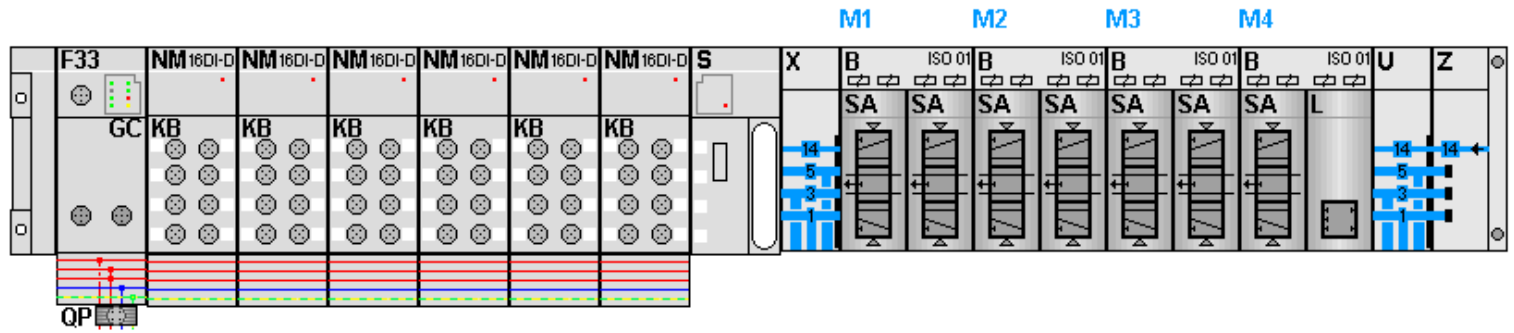

5

				Date: 9/22/2022		Volvo Trucks North America		Valiant Machine & Tool		AIR SUPPLY		Drawing name: =2V12&MFS-PNEU		= V1WR1UQ52KF1	
				Ed: MKLEPADLO		P6700 Rear Wall Hdr & Door Ring RH Cell		Scale 1:1				Document type: MFS		+ V1WR1UQ52	
				Appr:		Replacement of		Replaced by				Project nr: 22-16145		Page 11	
Modification				Date		Name		Original						57	

=V1WR1UQ52KF2/5

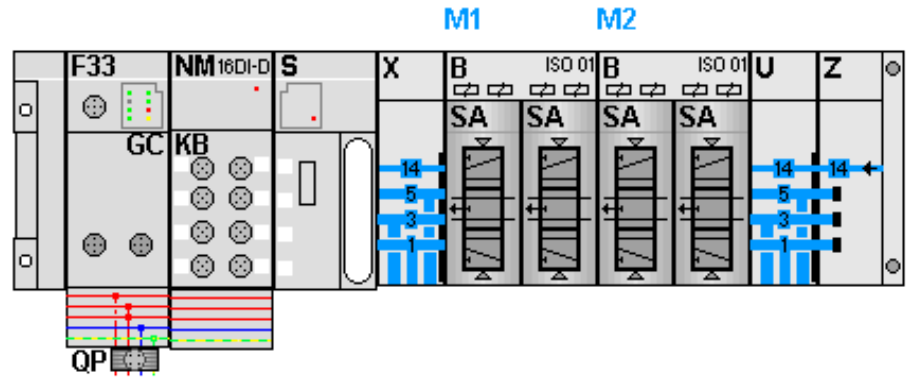

KF2.0

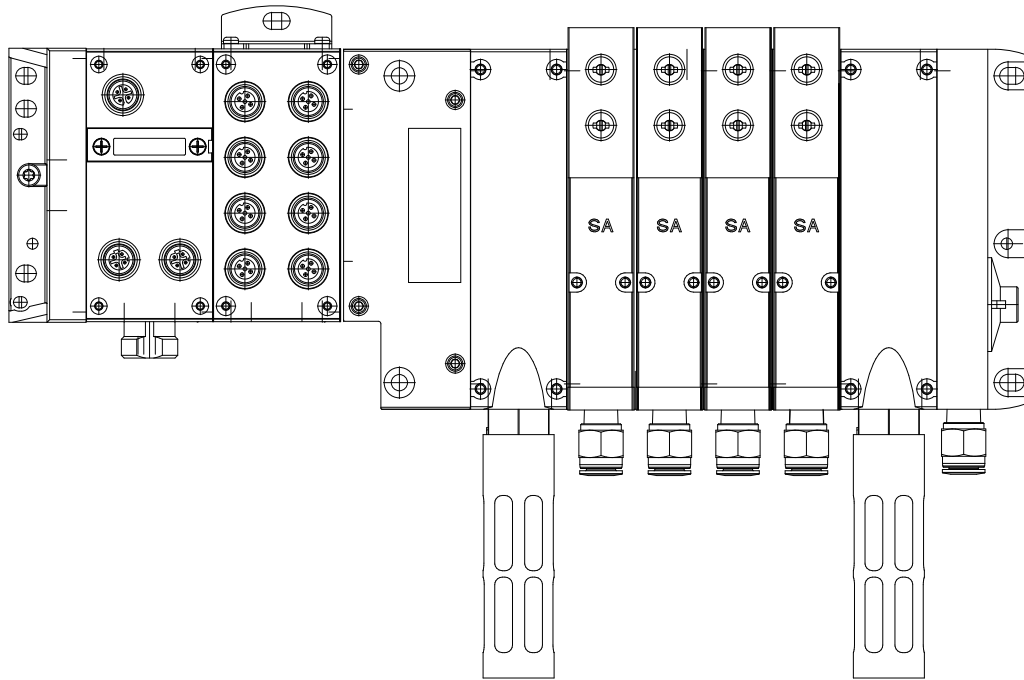

=V1WR1UQ52KF1/11

11

		Date	9/22/2022	Volvo Trucks North America		Valiant Machine & Tool	AIR SUPPLY CONFIGURATION		Drawing name: =2V12&MFS-PNEU		= V1WR1UQ52KF2 + V1WR1UQ52	
		Ed.	MKLEPADLO	P6700 Rear Wall Hdr & Door Ring RH Cell			Scale 1:1		Document type: MFS		Project nr: 22-16145	
Modification	Date	Name	Original	Replacement of	Replaced by							Page 57

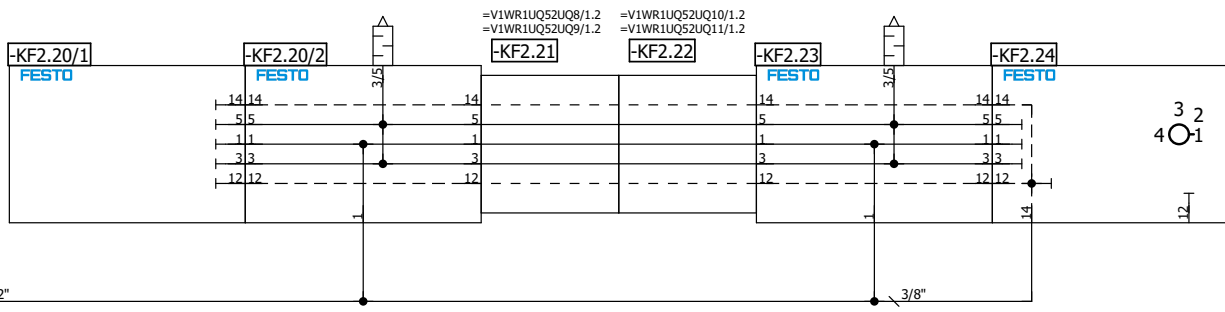
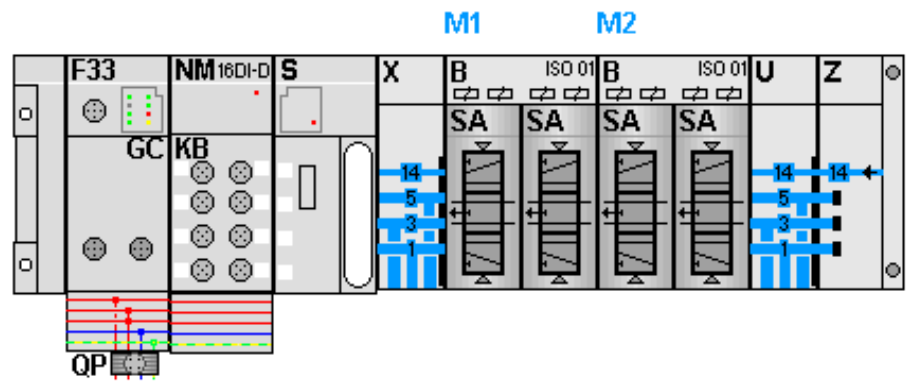

5

=V1WR1UQ52UQ1/1

		Date	9/22/2022	Volvo Trucks North America		Valiant Machine & Tool	AIR SUPPLY		Drawing name: =2V12&MFS-PNEU		= V1WR1UQ52KF2 + V1WR1UQ52	
		Ed.	MKLEPADLO	P6700 Rear Wall Hdr & Door Ring RH Cell			Scale 1:1			Document type: MFS		Project nr: 22-16145
Modification	Date	Name	Original	Replacement of	Replaced by					Page	11 57	

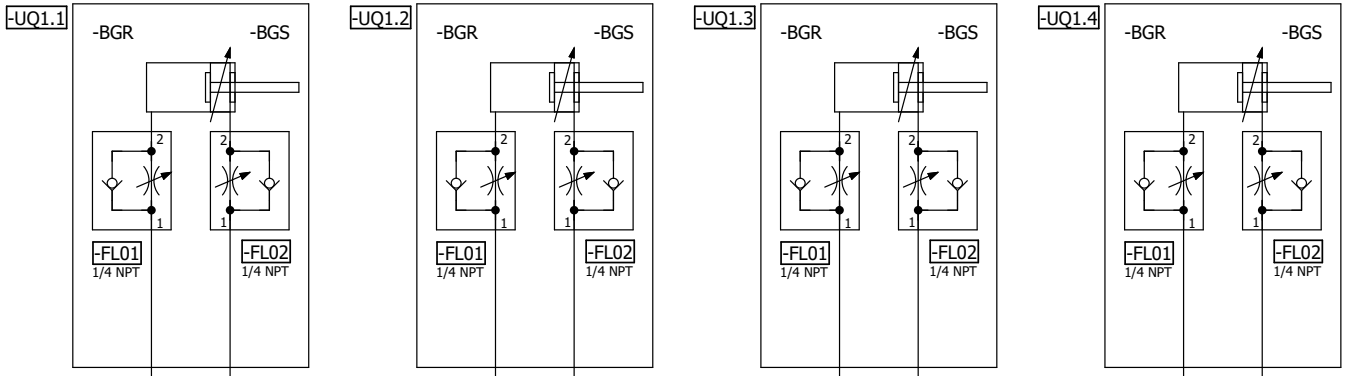

=V1WR1UQ52KF1

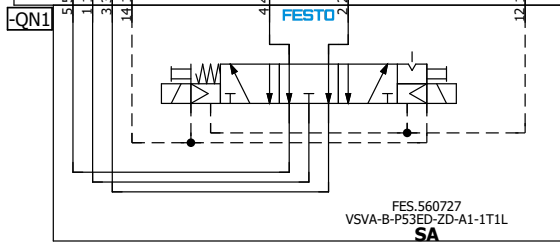
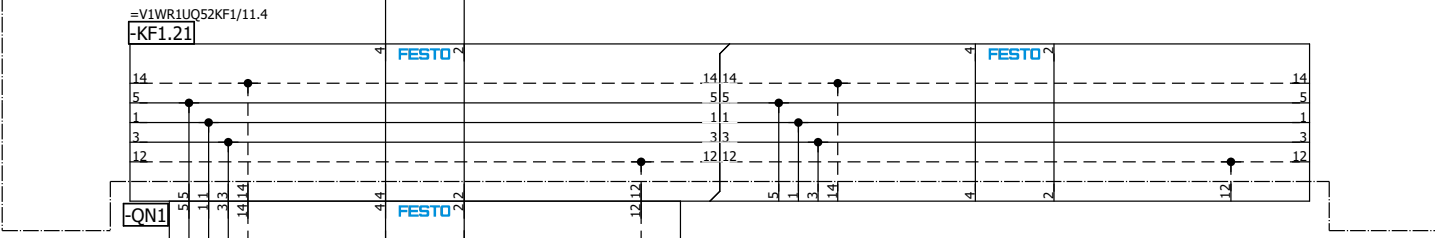

FES 560727  
VSVA-B-P53ED-ZD-A1-1T1L  
SA

=V1WR1UQ52  
-UQ1-QN1.1  
Shot Pins 1  
(RST)

=V1WR1UQ52  
-UQ1-QN1.2  
Shot Pins 1  
(SET)

=V1WR1UQ52UQ2/1

			Date	9/22/2022	Volvo Trucks North America	Valiant Machine & Tool		Shot Pins 1		Drawing name: =2V12&MFS-PNEU		= V1WR1UQ52UQ1 + V1WR1UQ52	
			Ed.	MKLEPADLO	P6700 Rear Wall Hdr & Door Ring RH Cell		Scale 1:1		Document type: MFS		Project nr: 22-16145		Page 1
Modification	Date	Name	Original		Replacement of	Replaced by							57

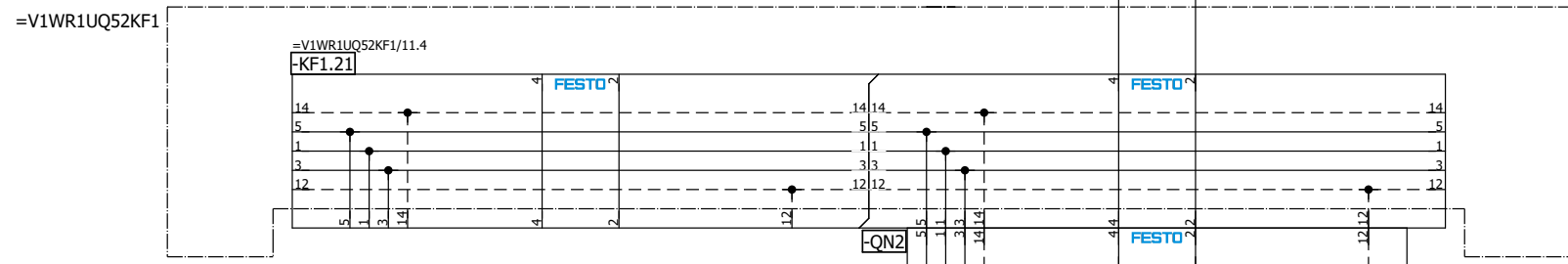
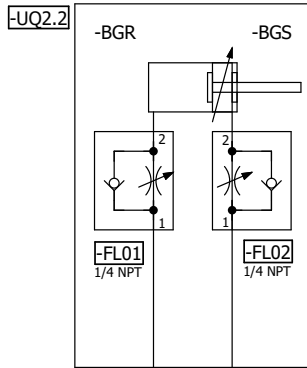
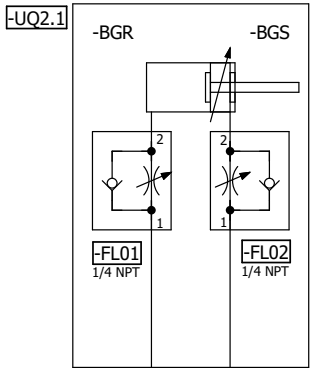

=V1WR1UQ52  
-UQ2-QN2.1  
Shot Pins 2  
(RST)

=V1WR1UQ52  
-UQ2-QN2.2  
Shot Pins 2  
(SET)

=V1WR1UQ52UQ3/1

=V1WR1UQ52UQ1/1		Date	9/22/2022	Volvo Trucks North America	Valiant Machine & Tool	Shot Pins 2	Drawing name:		= V1WR1UQ52UQ2
		Ed.	MKLEPADLO				= 2V12&MFS-PNEU		+ V1WR1UQ52
Modification	Date	Name	Original	Replacement of	Replaced by	Scale 1:1	Document type:	Project nr:	Page
							MFS	22-16145	1
									57

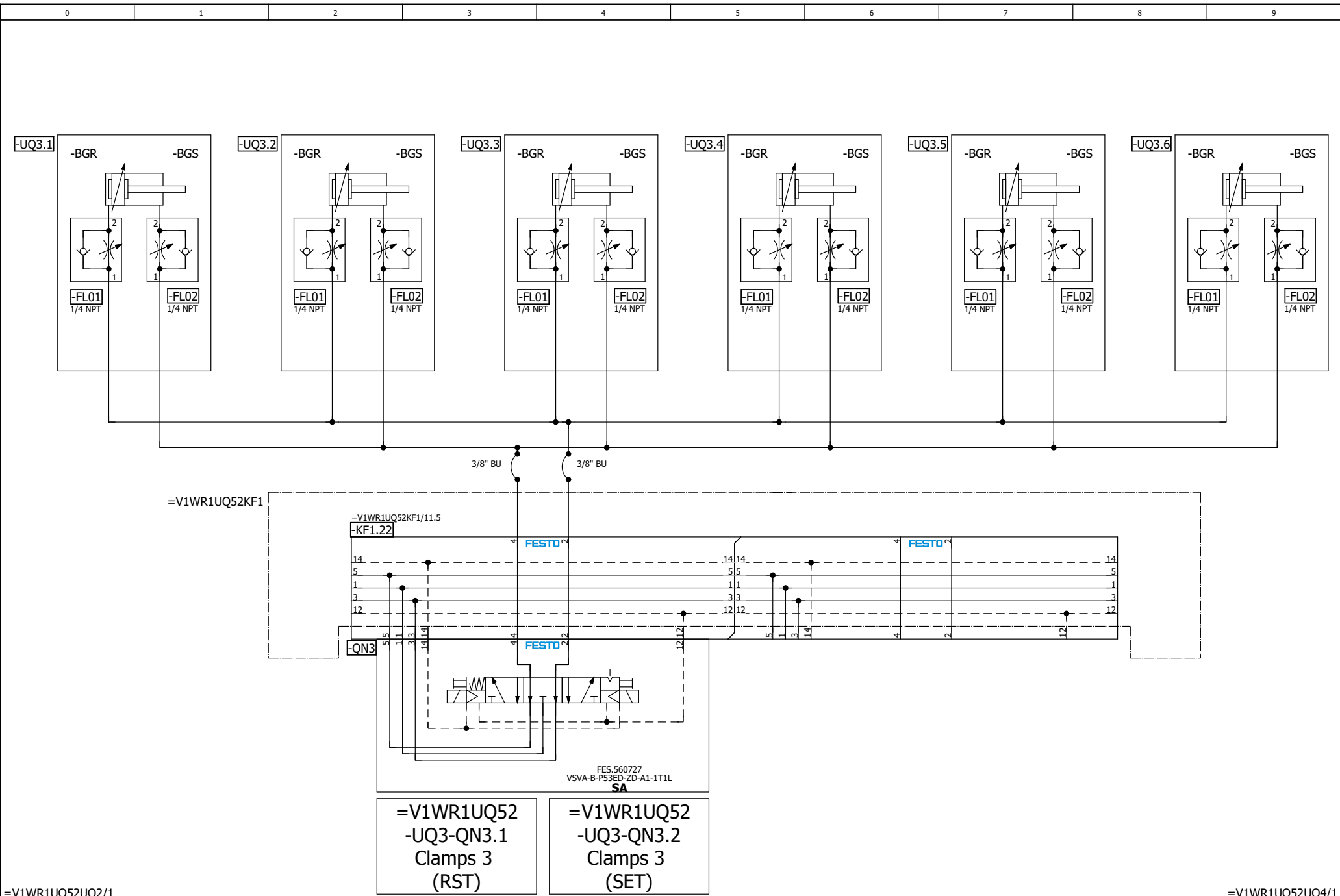

		Date	9/22/2022	Volvo Trucks North America	Valiant Machine & Tool	Clamps 3	Drawing name:	= V1WR1UQ52UQ3	
		Ed.	MKLEPADLO				= 2V12&MFS-PNEU	+ V1WR1UQ52	
		Appr		P6700 Rear Wall Hdr & Door Ring RH Cell	Scale 1:1		Document type:	MFS	
Modification	Date	Name	Original	Replacement of			Replaced by	Project nr:	22-16145
									57

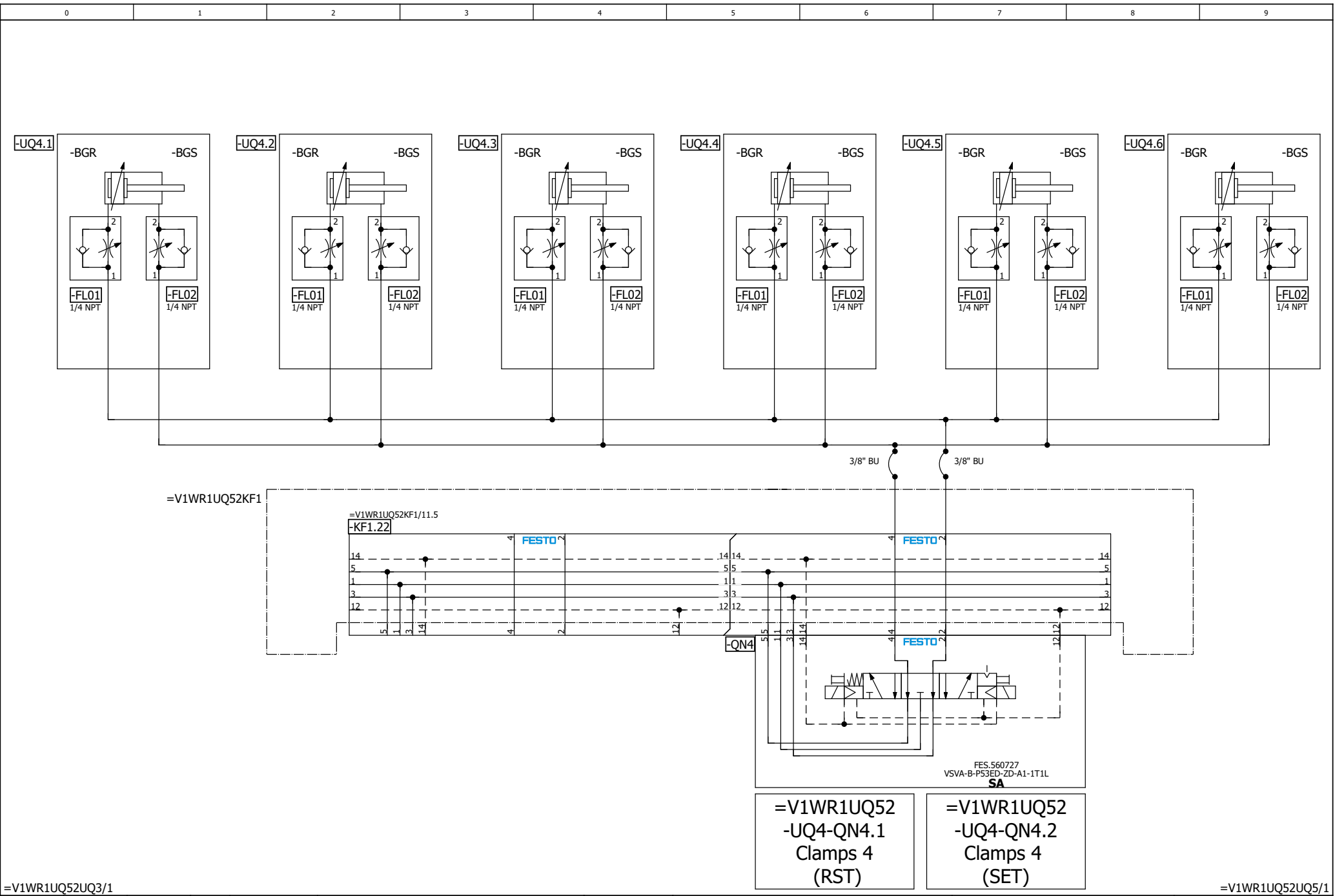

=V1WR1UQ52UQ3/1		Date	9/22/2022	Volvo Trucks North America	Valiant Machine & Tool	Clamps 4	Drawing name:	= 2V12&MFS-PNEU	= V1WR1UQ52UQ4			
		Ed.	MKLEPADLO						+ V1WR1UQ52			
		Appr		P6700 Rear Wall Hdr & Door Ring RH Cell	Scale 1:1		Document type:	MFS	Project nr:	22-16145	Page	1
Modification	Date	Name	Original	Replacement of			Replaced by					

=V1WR1UQ52UQ5/1

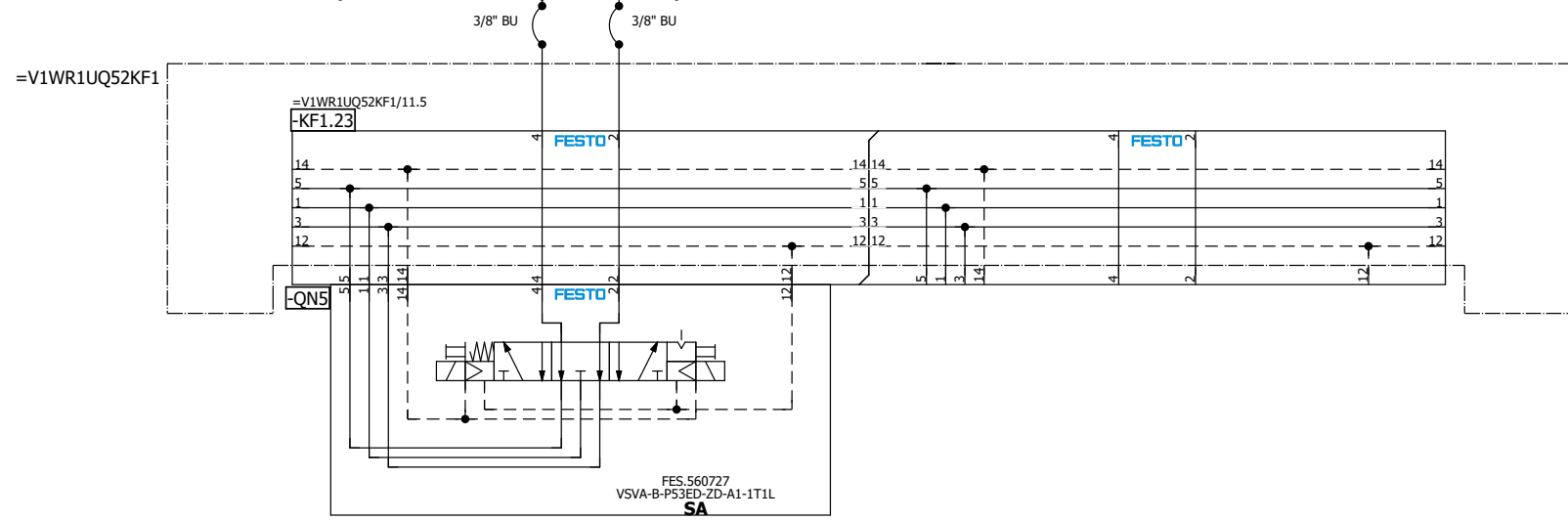
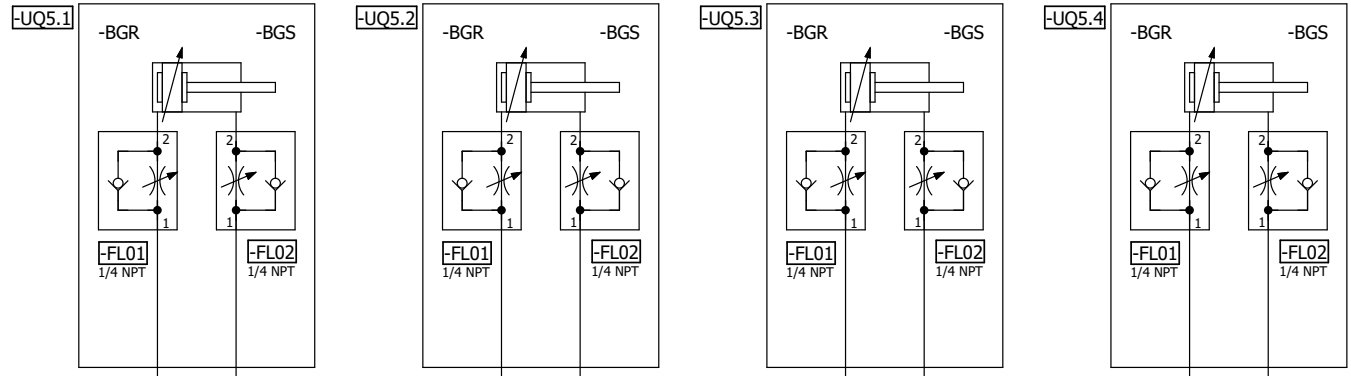

=V1WR1UQ52  
-UQ5-QN5.1  
Clamps 5  
(RST)

=V1WR1UQ52  
-UQ5-QN5.2  
Clamps 5  
(SET)

=V1WR1UQ52UQ4/1 =V1WR1UQ52UQ6/1

Date	9/22/2022	Volvo Trucks North America	Valiant Machine & Tool	Clamps 5	Drawing name:	= 2V12&MFS-PNEU	= V1WR1UQ52UQ5
Ed.	MKLEPADLO	P6700 Rear Wall Hdr & Door Ring RH Cell	Scale 1:1	Replacement of	Document type:	MFS	+ V1WR1UQ52
Appr					Project nr:	22-16145	Page
Modification	Date	Name	Original	Replaced by			57



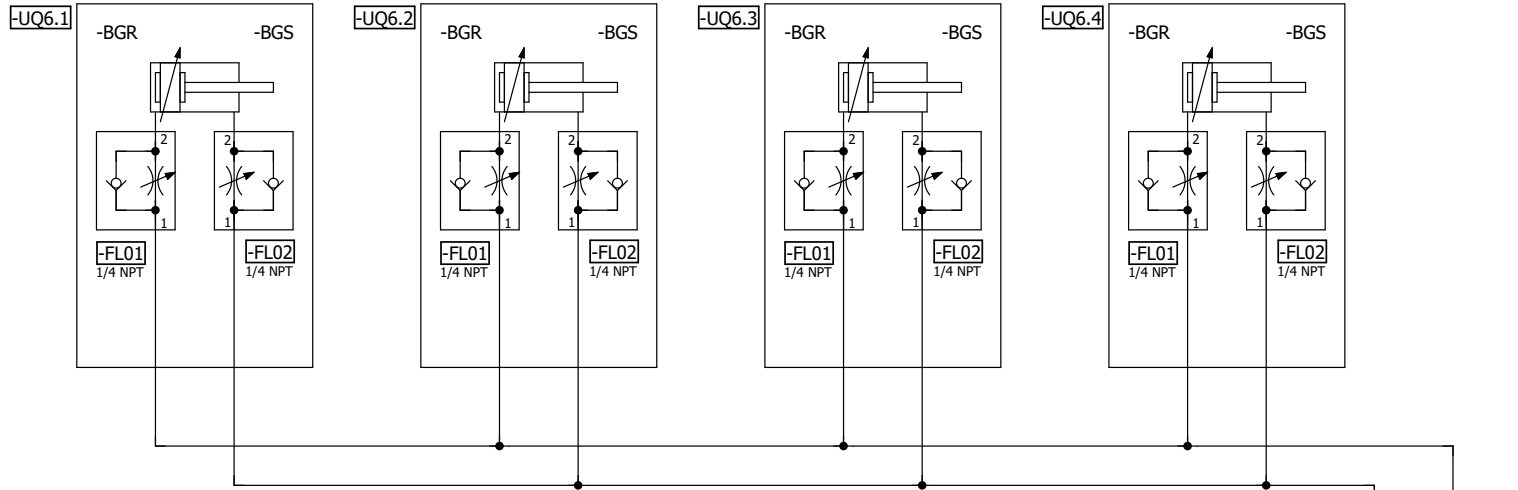

=V1WR1UQ52KF1

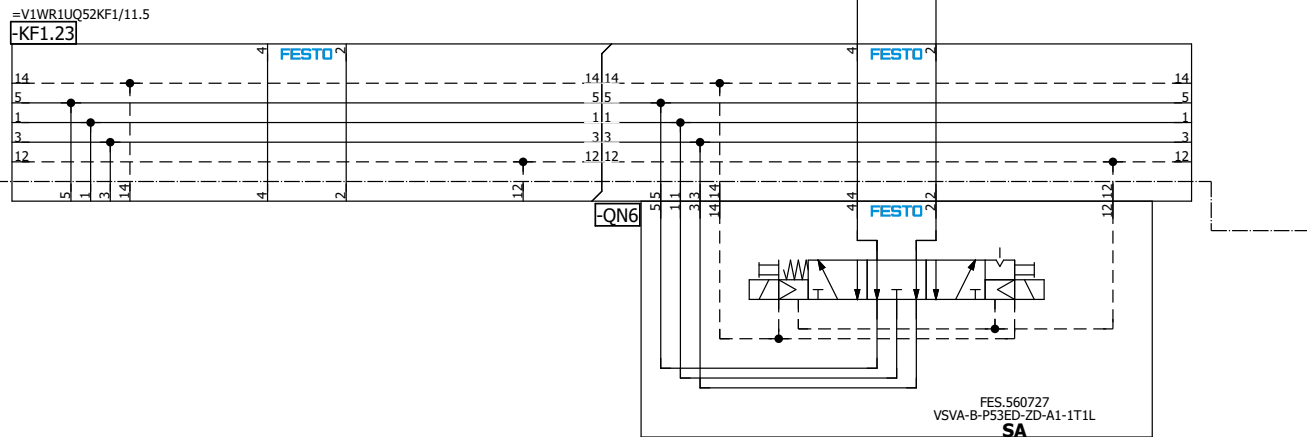

=V1WR1UQ52  
-UQ6-QN6.1  
Clamps 6  
(RST)

=V1WR1UQ52  
-UQ6-QN6.2  
Clamps 6  
(SET)

=V1WR1UQ52UQ7/1

			Date	9/22/2022	Volvo Trucks North America	Valiant Machine & Tool		Clamps 6		Drawing name: = 2V12&MFS-PNEU		= V1WR1UQ52UQ6		
			Ed.	MKLEPADLO	P6700 Rear Wall Hdr & Door Ring RH Cell	Scale 1:1				Document type:		+ V1WR1UQ52		
			Appr							MFS		Project nr: 22-16145		Page
Modification	Date	Name	Original		Replacement of	Replaced by					Page		57	

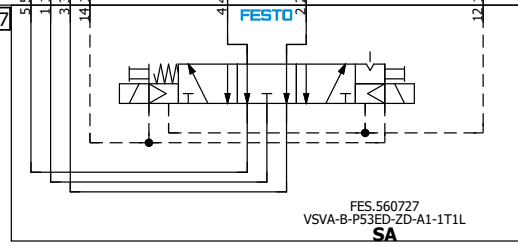
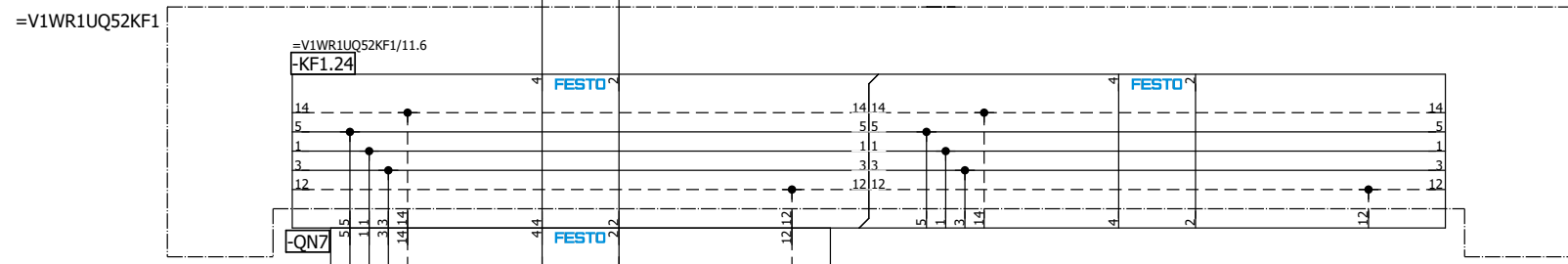
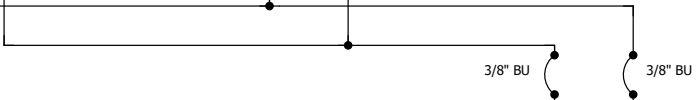
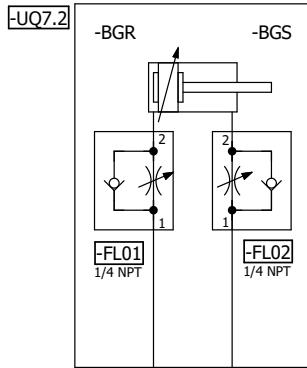
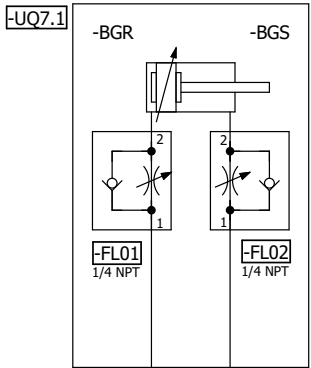

=V1WR1UQ52  
-UQ7-QN7.1  
Clamps 7  
(RST)

=V1WR1UQ52  
-UQ7-QN7.2  
Clamps 7  
(SET)

=V1WR1UQ52UQ6/1 =V1WR1UQ52UQ8/1

Date	9/22/2022	Volvo Trucks North America	Valiant Machine & Tool	Clamps 7	Drawing name:	= 2V12&MFS-PNEU	= V1WR1UQ52UQ7
Ed.	MKLEPADLO	P6700 Rear Wall Hdr & Door Ring RH Cell	Scale 1:1	Replacement of	Document type:	MFS	+ V1WR1UQ52
Appr					Project nr:	22-16145	Page
Modification	Date	Name	Original	Replaced by			57

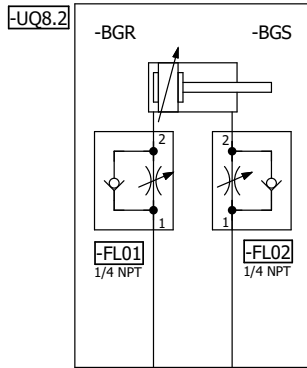
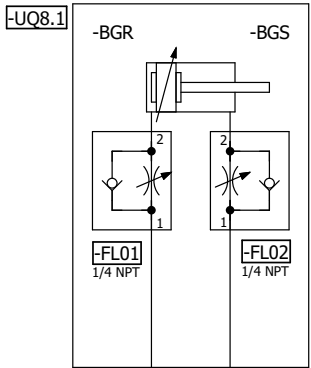

=V1WR1UQ52KF2

=V1WR1UQ52KF2/11.4

-KF2.21

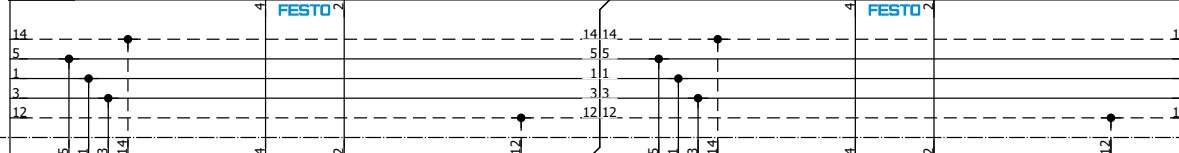

-QN8

=V1WR1UQ52  
-UQ8-QN8.1  
Clamps 8  
(RST)

=V1WR1UQ52  
-UQ8-QN8.2  
Clamps 8  
(SET)

=V1WR1UQ52UQ9/1

			Date	9/22/2022	Volvo Trucks North America		Valiant Machine & Tool	Clamps 8	Drawing name:		= V1WR1UQ52UQ8				
			Ed.	MKLEPADLO					= 2V12&MFS-PNEU		+ V1WR1UQ52				
			Appr		P6700 Rear Wall Hdr & Door Ring RH Cell		Scale 1:1	Document type:		MFS	Project nr:		22-16145	Page	1
Modification	Date	Name	Original		Replacement of	Replaced by									

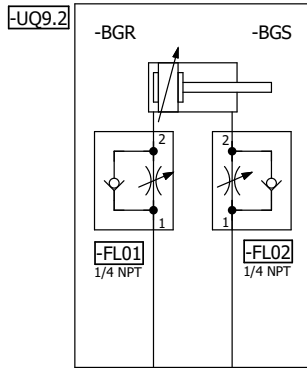
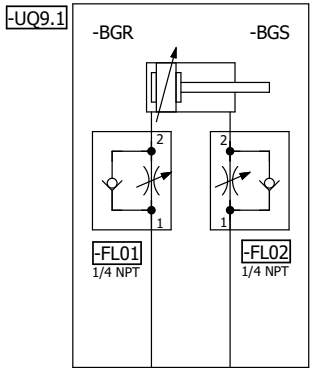

3/8" BU 3/8" BU

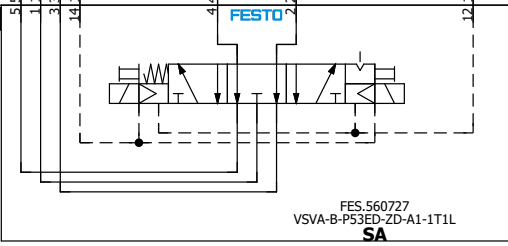
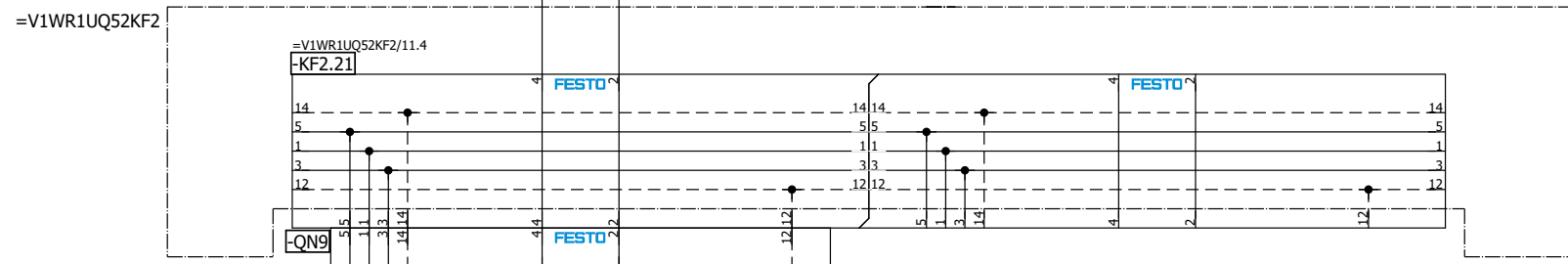

=V1WR1UQ52  
 -UQ9-QN9.1  
 Clamps 9  
 (RST)

=V1WR1UQ52  
 -UQ9-QN9.2  
 Clamps 9  
 (SET)

=V1WR1UQ52UQ8/1 =V1WR1UQ52UQ10/1

Date	9/22/2022	Volvo Trucks North America	Valiant Machine & Tool	Clamps 9	Drawing name:	= 2V12&MFS-PNEU	= V1WR1UQ52UQ9
Ed.	MKLEPADLO	P6700 Rear Wall Hdr & Door Ring RH Cell	Scale 1:1	Replacement of	Document type:	MFS	+ V1WR1UQ52
Appr					Project nr:	22-16145	Page
Modification	Date	Name	Original	Replaced by			57

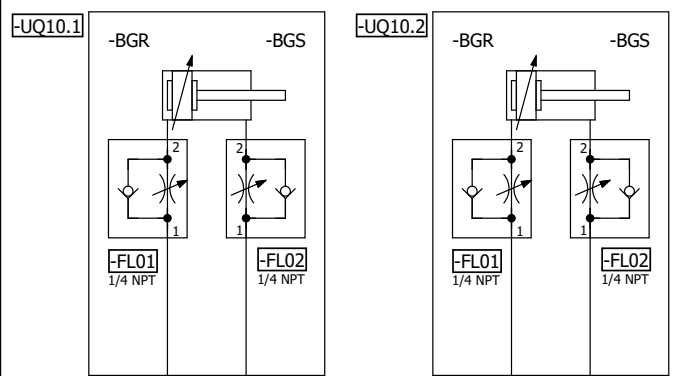

=V1WR1UQ52KF2

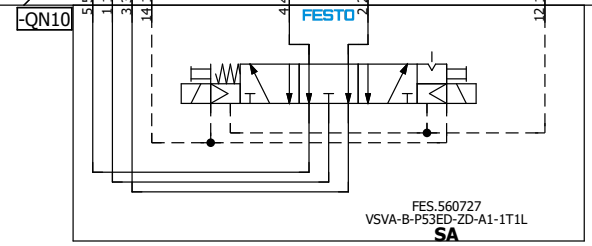
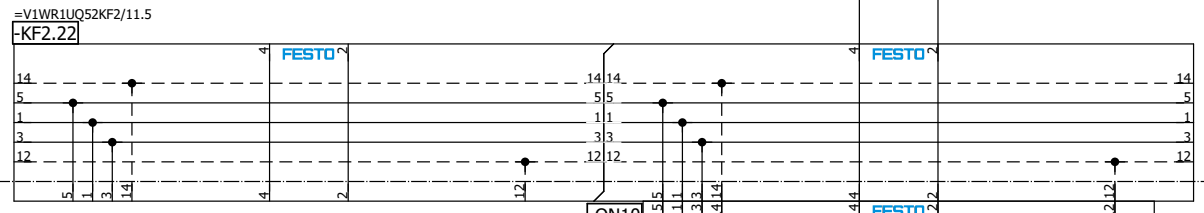

=V1WR1UQ52  
-UQ10-QN10.1  
Clamps 10  
(RST)

=V1WR1UQ52  
-UQ10-QN10.2  
Clamps 10  
(SET)

=V1WR1UQ52UQ11/1

		Date	9/22/2022	Volvo Trucks North America	Valiant Machine & Tool	Clamps 10	Drawing name:		= V1WR1UQ52UQ10
		Ed.	MKLEPADLO				= 2V12&MFS-PNEU		+ V1WR1UQ52
		Appr		P6700 Rear Wall Hdr & Door Ring RH Cell	Scale 1:1		Document type:	Project nr:	Page
Modification	Date	Name	Original	Replacement of			Replaced by	MFS	22-16145
									57

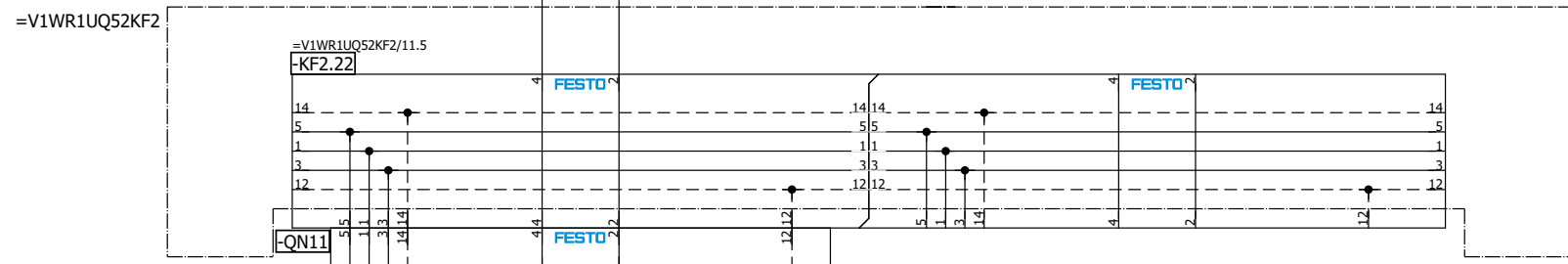
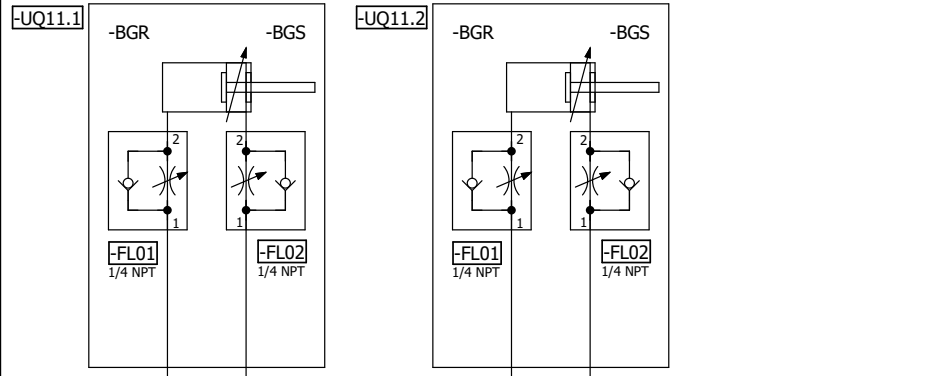

FES 560727  
VSVA-B-P53ED-ZD-A1-1T1L  
**SA**

=V1WR1UQ52  
-UQ11-QN11.1  
Shot Pins 11  
(RST)

=V1WR1UQ52  
-UQ11-QN11.2  
Shot Pins 11  
(SET)

=V1WR1UQ52UQ10/1

=V1WR1UQ52UQ12/1

Date	9/22/2022	Volvo Trucks North America	Valiant Machine & Tool	Clamps 11	Drawing name:	= 2V12&MFS-PNEU	= V1WR1UQ52UQ11
Ed.	MKLEPADLO	P6700 Rear Wall Hdr & Door Ring RH Cell	Scale 1:1	Document type:	MFS	Project nr:	22-16145
Appr							
Modification	Date	Name	Original				57

















# Parts list

F01\_001

Device tag	Quantity	Designation	Type number	Supplier	Part number
=V1WR1UQ51KF1-KF1.0	1	Valve manifold	51E-F33GCPNMKBNMKB-S-UL1+GS2GZBA & 45PN-R-2E5SMX-3BU-6SA	FES.51E-F33GCPNMKBNMKB-S-UL1+GS2GZBA & 45PN-R-2E5SMX-3BU-6SA	
=V1WR1UQ51KF1-KF1.21	0	Manifold subbase	VABV-S4-IHS-N14-2T2		FES.546213
=V1WR1UQ51KF1-KF1.22	0	Manifold subbase	VABV-S4-IHS-N14-2T2		FES.546213
=V1WR1UQ51KF1-KF1.23	0	Manifold subbase	VABV-S4-IHS-N14-2T2		FES.546213
=V1WR1UQ51UQ1-QN1	0	Solenoid valve	VSVA-B-P53ED-ZD-A1-1T1L		FES.560727
=V1WR1UQ51UQ1-UQ1.1-FL01	1	One-way flow control valve	GRLA-1/4-QB-3/8-U		FES.534663
=V1WR1UQ51UQ1-UQ1.1-FL02	1	One-way flow control valve	GRLA-1/4-QB-3/8-U		FES.534663
=V1WR1UQ51UQ1-UQ1.2-FL01	1	One-way flow control valve	GRLA-1/4-QB-3/8-U		FES.534663
=V1WR1UQ51UQ1-UQ1.2-FL02	1	One-way flow control valve	GRLA-1/4-QB-3/8-U		FES.534663
=V1WR1UQ51UQ1-UQ1.3-FL01	1	One-way flow control valve	GRLA-1/4-QB-3/8-U		FES.534663
=V1WR1UQ51UQ1-UQ1.3-FL02	1	One-way flow control valve	GRLA-1/4-QB-3/8-U		FES.534663
=V1WR1UQ51UQ1-UQ1.4-FL01	1	One-way flow control valve	GRLA-1/4-QB-3/8-U		FES.534663
=V1WR1UQ51UQ1-UQ1.4-FL02	1	One-way flow control valve	GRLA-1/4-QB-3/8-U		FES.534663
=V1WR1UQ51UQ1-UQ1.5-FL01	1	One-way flow control valve	GRLA-1/4-QB-3/8-U		FES.534663
=V1WR1UQ51UQ1-UQ1.5-FL02	1	One-way flow control valve	GRLA-1/4-QB-3/8-U		FES.534663
=V1WR1UQ51UQ2-QN2	0	Solenoid valve	VSVA-B-P53ED-ZD-A1-1T1L		FES.560727
=V1WR1UQ51UQ2-UQ2.1-FL01	1	One-way flow control valve	GRLA-1/4-QB-3/8-U		FES.534663
=V1WR1UQ51UQ2-UQ2.1-FL02	1	One-way flow control valve	GRLA-1/4-QB-3/8-U		FES.534663
=V1WR1UQ51UQ3-QN3	0	Solenoid valve	VSVA-B-P53ED-ZD-A1-1T1L		FES.560727
=V1WR1UQ51UQ3-UQ3.1-FL01	1	One-way flow control valve	GRLA-1/4-QB-3/8-U		FES.534663
=V1WR1UQ51UQ3-UQ3.1-FL02	1	One-way flow control valve	GRLA-1/4-QB-3/8-U		FES.534663
=V1WR1UQ51UQ4-QN4	0	Solenoid valve	VSVA-B-P53ED-ZD-A1-1T1L		FES.560727
=V1WR1UQ51UQ4-UQ4.1-FL01	1	One-way flow control valve	GRLA-1/4-QB-3/8-U		FES.534663
=V1WR1UQ51UQ4-UQ4.1-FL02	1	One-way flow control valve	GRLA-1/4-QB-3/8-U		FES.534663
=V1WR1UQ51UQ4-UQ4.2-FL01	1	One-way flow control valve	GRLA-1/4-QB-3/8-U		FES.534663
=V1WR1UQ51UQ4-UQ4.2-FL02	1	One-way flow control valve	GRLA-1/4-QB-3/8-U		FES.534663
=V1WR1UQ51UQ4-UQ4.3-FL01	1	One-way flow control valve	GRLA-1/4-QB-3/8-U		FES.534663
=V1WR1UQ51UQ4-UQ4.3-FL02	1	One-way flow control valve	GRLA-1/4-QB-3/8-U		FES.534663
=V1WR1UQ51UQ4-UQ4.4-FL01	1	One-way flow control valve	GRLA-1/4-QB-3/8-U		FES.534663
=V1WR1UQ51UQ4-UQ4.4-FL02	1	One-way flow control valve	GRLA-1/4-QB-3/8-U		FES.534663
=V1WR1UQ51UQ4-UQ4.5-FL01	1	One-way flow control valve	GRLA-1/4-QB-3/8-U		FES.534663
=V1WR1UQ51UQ4-UQ4.5-FL02	1	One-way flow control valve	GRLA-1/4-QB-3/8-U		FES.534663
=V1WR1UQ51UQ4-UQ4.6-FL01	1	One-way flow control valve	GRLA-1/4-QB-3/8-U		FES.534663
=V1WR1UQ51UQ4-UQ4.6-FL02	1	One-way flow control valve	GRLA-1/4-QB-3/8-U		FES.534663
=V1WR1UQ51UQ5-QN5	0	Solenoid valve	VSVA-B-P53ED-ZD-A1-1T1L		FES.560727
=V1WR1UQ51UQ5-UQ5.1-FL01	1	One-way flow control valve	GRLA-1/4-QB-3/8-U		FES.534663
=V1WR1UQ51UQ5-UQ5.1-FL02	1	One-way flow control valve	GRLA-1/4-QB-3/8-U		FES.534663
=V1WR1UQ51UQ5-UQ5.2-FL01	1	One-way flow control valve	GRLA-1/4-QB-3/8-U		FES.534663
=V1WR1UQ51UQ5-UQ5.2-FL02	1	One-way flow control valve	GRLA-1/4-QB-3/8-U		FES.534663
=V1WR1UQ51UQ5-UQ5.3-FL01	1	One-way flow control valve	GRLA-1/4-QB-3/8-U		FES.534663
=V1WR1UQ51UQ5-UQ5.3-FL02	1	One-way flow control valve	GRLA-1/4-QB-3/8-U		FES.534663
=V1WR1UQ51UQ6-QN6	0	Solenoid valve	VSVA-B-P53ED-ZD-A1-1T1L		FES.560727
=V1WR1UQ51UQ6-UQ6.1-FL01	1	One-way flow control valve	GRLA-1/4-QB-3/8-U		FES.534663
=V1WR1UQ51UQ6-UQ6.1-FL02	1	One-way flow control valve	GRLA-1/4-QB-3/8-U		FES.534663

+ .UQ51/1

+ .WR1UQ52/1

Date	9/22/2022	Volvo Trucks North America	 Valiant Machine & Tool	Material specification	Drawing name:	=		
Ed.	MKLEPADLO				= 2V12&MFS-PNEU	+ V1WR1UQ51		
Appr		P6700 Rear Wall Hdr & Door Ring RH Cell	 Scale 1:1		Document type:	Project nr:	Page	1
Modification	Date	Name		Original	Replacement of	Replaced by	MPB	22-16145









