

# Valiant TMS



Company / customer Volvo Trucks NA  
 Project description P6700 Framing - Cell 2V01, KF1  
 drawing number 22-16152  
 Commission Volvo Trucks North America



Manufacturer (company) Valiant TMS  
  
 Project name =2V01&MFS-PNEU\_KF1  
  
 Type P6700 Framing - Cell 2V01, KF1

Created on 7/26/2022  
 Edit date 1/18/2023 by (short name) MKLEPADLO  
 Number of pages 275

			Date	1/18/2023	Volvo Trucks North America		Valiant TMS	Title page / cover sheet	Drawing name:	=		
			Ed.	MKLEPADLO	P6700 Framing - Cell 2V01, KF1				=2V01&MFS-PNEU_KF1		+	
Modification	Date	Name	Original		Replacement of		Replaced by		Scale 1:1	Document type:	Project nr:	Page
								MAA	22-16152		275	

# Table of contents

Column X: An automatically generated page was edited

F06\_001

Page	Page description	supplementary page field	Date	Edited by	X
&MAA/1	Title page / cover sheet		1/18/2023	MKLEPADLO	
&MAB/1	Table of contents : &MAA/1 - &MFS=V1AR31XQ41UQ2+V1AR31KF1/1		1/18/2023	MKLEPADLO	
&MAB/2	Table of contents : &MFS=V1AR41UQ41KF1+V1AR41UQ41/1 - &MFS=V1UQ53KF1+V1UQ53/5		1/18/2023	MKLEPADLO	
&MAB/3	Table of contents : &MFS=V1UQ53KF1+V1UQ53/11 - &MFS=V2AR32UQ41UQ1+V2AR32UQ41/1		1/18/2023	MKLEPADLO	
&MAB/4	Table of contents : &MFS=V2AR32UQ41UQ2+V2AR32UQ41/1 - &MFS=V2AR42UQ42KF1+V2AR42UQ42/1		1/18/2023	MKLEPADLO	
&MAB/5	Table of contents : &MFS=V2AR42UQ42KF1+V2AR42UQ42/5 - &MFS=V2AR44UQ41KF1+V2AR44UQ41/5		1/18/2023	MKLEPADLO	
&MAB/6	Table of contents : &MFS=V2AR44UQ41KF1+V2AR44UQ41/11 - &MFS=V2GL16+KH1/1		1/18/2023	MKLEPADLO	
&MAB/7	Table of contents : &MFS=V2GL16UQ51KF2+V2GL16UQ51/5 - &MFS=V2UQ31UQ8+V2UQ31/1		1/18/2023	MKLEPADLO	
&MAB/8	Table of contents : &MFS=V2UQ31UQ9+V2UQ31/1 - &MPB+V2AR43UQ41/1		1/18/2023	MKLEPADLO	
&MAB/9	Table of contents : &MPB+V2AR43UQ42/1 - &MPB+V2UQ31/2		1/18/2023	MKLEPADLO	
&MFS=KH0+KH0/1	Incoming air supply		12/15/2022	MKLEPADLO	
&MFS=V1AR11UQ41KF1+V1AR11UQ41/1	AIR SUPPLY GRIPPER		1/3/2023	MKLEPADLO	
&MFS=V1AR11UQ41KF1+V1AR11UQ41/5	AIR SUPPLY		1/4/2023	MKLEPADLO	
&MFS=V1AR11UQ41KF1+V1AR11UQ41/11	AIR SUPPLY		1/3/2023	MKLEPADLO	
&MFS=V1AR11UQ41UQ1+V1AR11UQ41/1	Common Clamps		1/17/2023	MKLEPADLO	
&MFS=V1AR11UQ41UQ2+V1AR11UQ41/1	L150 Model Clamps		1/17/2023	MKLEPADLO	
&MFS=V1AR11UQ41UQ3+V1AR11UQ41/1	L230 Model Clamps		1/17/2023	MKLEPADLO	
&MFS=V1AR11UQ41UQ4+V1AR11UQ41/1	L290 Model Clamps		1/17/2023	MKLEPADLO	
&MFS=V1AR11UQ41UQ5+V1AR11UQ41/1	L320 Model Clamps		1/17/2023	MKLEPADLO	
&MFS=V1AR11UQ41UQ6+V1AR11UQ41/1	Common Vacuums		12/15/2022	MKLEPADLO	
&MFS=V1AR11UQ41UQ7+V1AR11UQ41/1	L230 Model Vacuums		12/15/2022	MKLEPADLO	
&MFS=V1AR11UQ41UQ8+V1AR11UQ41/1	L290 Model Vacuums		12/15/2022	MKLEPADLO	
&MFS=V1AR11UQ41UQ9+V1AR11UQ41/1	L320 Model Vacuums		12/15/2022	MKLEPADLO	
&MFS=V1AR11UQ41UQ10+V1AR11UQ41/1	Spare		12/15/2022	MKLEPADLO	
&MFS=V1AR31UQ41KF1+V1AR31UQ41/1	AIR SUPPLY GRIPPER		1/3/2023	MKLEPADLO	
&MFS=V1AR31UQ41KF1+V1AR31UQ41/5	AIR SUPPLY		1/17/2023	MKLEPADLO	
&MFS=V1AR31UQ41KF1+V1AR31UQ41/11	AIR SUPPLY		1/17/2023	MKLEPADLO	
&MFS=V1AR31UQ41UQ1+V1AR31UQ41/1	Common Clamps		1/17/2023	MKLEPADLO	
&MFS=V1AR31UQ41UQ2+V1AR31UQ41/1	Spare		12/15/2022	MKLEPADLO	
&MFS=V1AR31XQ41KF1+V1AR31KF1/5	AIR SUPPLY CONFIGURATION		1/17/2023	MKLEPADLO	
&MFS=V1AR31XQ41KF1+V1AR31KF1/11	AIR SUPPLY		1/17/2023	MKLEPADLO	
&MFS=V1AR31XQ41UQ1+V1AR31KF1/1	Cylinder		1/17/2023	MKLEPADLO	
&MFS=V1AR31XQ41UQ2+V1AR31KF1/1	Spare		12/15/2022	MKLEPADLO	

&MAA/1

2

Date	1/18/2023	Volvo Trucks North America		Valiant TMS	Table of contents : &MAA/1 - &MFS=V1AR31XQ41UQ2+V1AR31KF1/1	Drawing name:	=	=2V01&MFS-PNEU_KF1	Project nr:	22-16152	Page	1
Ed.	MKLEPADLO	P6700 Framing - Cell 2V01, KF1		Scale 1:1		Document type:	MAB				+	275
Modification	Date	Name	Original	Replacement of	Replaced by							

# Table of contents

Column X: An automatically generated page was edited

F06\_001

Page	Page description	supplementary page field	Date	Edited by	X
&MFS=V1AR41UQ41KF1+V1AR41UQ41/1	AIR SUPPLY GRIPPER		1/3/2023	MKLEPADLO	
&MFS=V1AR41UQ41KF1+V1AR41UQ41/5	AIR SUPPLY		1/17/2023	MKLEPADLO	
&MFS=V1AR41UQ41KF1+V1AR41UQ41/1	AIR SUPPLY		1/17/2023	MKLEPADLO	
&MFS=V1AR41UQ41UQ1+V1AR41UQ41/1	Common Shot Pins		1/17/2023	MKLEPADLO	
&MFS=V1AR41UQ41UQ2+V1AR41UQ41/1	Common Clamps 1		1/17/2023	MKLEPADLO	
&MFS=V1AR41UQ41UQ3+V1AR41UQ41/1	Common Clamps 2		1/17/2023	MKLEPADLO	
&MFS=V1AR41UQ41UQ4+V1AR41UQ41/1	Part Positioner		1/17/2023	MKLEPADLO	
&MFS=V1GL13+KH1/1	Incoming air supply (Conveyor)		12/15/2022	MKLEPADLO	
&MFS=V1GL13UQ51KF2+V1GL13UQ51/5	AIR SUPPLY CONFIGURATION		1/17/2023	MKLEPADLO	
&MFS=V1GL13UQ51KF2+V1GL13UQ51/1	AIR SUPPLY		1/17/2023	MKLEPADLO	
&MFS=V1GL13UQ51UQ5+V1GL13UQ51/1	Pallet Stop Station #5 Pre-Unload		1/17/2023	MKLEPADLO	
&MFS=V1GL13UQ51UQ6+V1GL13UQ51/1	Pallet Stop Station #6 Unload		12/20/2022	MKLEPADLO	
&MFS=V1GL13UQ51UQ7+V1GL13UQ51/1	Pallet Stop Station #7 Mid-Stop #4		1/17/2023	MKLEPADLO	
&MFS=V1GL13UQ51UQ12+V1GL13UQ51/1	Spare		1/16/2023	MKLEPADLO	
&MFS=V1GL14+KH1/1	Incoming air supply (Conveyor)		12/20/2022	MKLEPADLO	
&MFS=V1GL14UQ51KF2+V1GL14UQ51/5	AIR SUPPLY CONFIGURATION		1/17/2023	MKLEPADLO	
&MFS=V1GL14UQ51KF2+V1GL14UQ51/1	AIR SUPPLY		1/17/2023	MKLEPADLO	
&MFS=V1GL14UQ51UQ3+V1GL14UQ51/1	Pallet Stop Station #3 Pre-Unload		1/17/2023	MKLEPADLO	
&MFS=V1GL14UQ51UQ4+V1GL14UQ51/1	Pallet Stop Station #4 Unload		12/20/2022	MKLEPADLO	
&MFS=V1GL14UQ51UQ5+V1GL14UQ51/1	Pallet Stop Station #5 Mid-Stop #2		1/17/2023	MKLEPADLO	
&MFS=V1GL14UQ51UQ8+V1GL14UQ51/1	Spare		12/20/2022	MKLEPADLO	
&MFS=V1GM1+KH1/1	Incoming air supply (Lift Assist)		12/20/2022	MKLEPADLO	
&MFS=V1UL1UQ1+V1UL1/1	Common Pin Clamp 1		1/17/2023	MKLEPADLO	
&MFS=V1UL1UQ2+V1UL1/1	Common Pin Clamp 2		1/17/2023	MKLEPADLO	
&MFS=V1UL1UQ3+V1UL1/1	Common Pin Clamp 3		1/17/2023	MKLEPADLO	
&MFS=V1UL1UQ4+V1UL1/1	L150 Model Slide		1/17/2023	MKLEPADLO	
&MFS=V1UQ31+KH1/1	Incoming air supply (Fixture)		12/20/2022	MKLEPADLO	
&MFS=V1UQ31KF1+V1UQ31/5	AIR SUPPLY CONFIGURATION		1/17/2023	MKLEPADLO	
&MFS=V1UQ31KF1+V1UQ31/11	AIR SUPPLY		1/17/2023	MKLEPADLO	
&MFS=V1UQ31UQ1+V1UQ31/1	MH1 Clamps		12/20/2022	MKLEPADLO	
&MFS=V1UQ31UQ2+V1UQ31/1	Common Clamps		12/20/2022	MKLEPADLO	
&MFS=V1UQ53+KH1/1	Incoming air supply (Fixture)		12/20/2022	MKLEPADLO	
&MFS=V1UQ53KF1+V1UQ53/5	AIR SUPPLY CONFIGURATION		1/17/2023	MKLEPADLO	

Date	1/18/2023	Volvo Trucks North America		Valiant TMS	Table of contents : &MFS=V1AR41UQ41KF1+V1AR41UQ41/1 - &MFS=V1UQ53KF1+V1UQ53/5	Drawing name:	=	=2V01&MFS-PNEU_KF1	Project nr: 22-16152	Page 2
Ed.	MKLEPADLO	P6700 Framing - Cell 2V01, KF1		Scale 1:1		Document type:	MAB			
Modification	Date	Name	Original	Replacement of	Replaced by					

# Table of contents

Column X: An automatically generated page was edited

F06\_001

Page	Page description	supplementary page field	Date	Edited by	X
&MFS=V1UQ53KF1+V1UQ53/11	AIR SUPPLY		1/17/2023	MKLEPADLO	
&MFS=V1UQ53UQ1+V1UQ53/1	Common Pin Clamp 1		1/17/2023	MKLEPADLO	
&MFS=V1UQ53UQ2+V1UQ53/1	Common Pin Clamp 2		1/17/2023	MKLEPADLO	
&MFS=V1UQ53UQ3+V1UQ53/1	Common Pin Clamp 3		1/17/2023	MKLEPADLO	
&MFS=V1UQ53UQ4+V1UQ53/1	L150 Model Slide		1/17/2023	MKLEPADLO	
&MFS=V1UQ53UQ5+V1UQ53/1	Mobile Supply Assembly		1/17/2023	MKLEPADLO	
&MFS=V1UQ53UQ6+V1UQ53/1	Spare		12/20/2022	MKLEPADLO	
&MFS=V2AR31UQ41KF1+V2AR31UQ41/1	AIR SUPPLY GRIPPER		1/3/2023	MKLEPADLO	
&MFS=V2AR31UQ41KF1+V2AR31UQ41/5	AIR SUPPLY		1/17/2023	MKLEPADLO	
&MFS=V2AR31UQ41KF1+V2AR31UQ41/1	AIR SUPPLY		1/17/2023	MKLEPADLO	
&MFS=V2AR31UQ41UQ1+V2AR31UQ41/1	Common Shot Pin		1/17/2023	MKLEPADLO	
&MFS=V2AR31UQ41UQ2+V2AR31UQ41/1	Common Clamps		1/17/2023	MKLEPADLO	
&MFS=V2AR31UQ41UQ3+V2AR31UQ41/1	L230 Model Clamps		1/17/2023	MKLEPADLO	
&MFS=V2AR31UQ41UQ4+V2AR31UQ41/1	L290 Model Shot Pin		1/17/2023	MKLEPADLO	
&MFS=V2AR31UQ41UQ5+V2AR31UQ41/1	L290 Model Clamps		1/17/2023	MKLEPADLO	
&MFS=V2AR31UQ41UQ6+V2AR31UQ41/1	L320 Model Shot Pin		1/17/2023	MKLEPADLO	
&MFS=V2AR31UQ41UQ7+V2AR31UQ41/1	L320 Model Clamps		1/17/2023	MKLEPADLO	
&MFS=V2AR31UQ41UQ8+V2AR31UQ41/1	Spare		12/20/2022	MKLEPADLO	
&MFS=V2AR31UQ42KF1+V2AR31UQ42/1	AIR SUPPLY GRIPPER		1/3/2023	MKLEPADLO	
&MFS=V2AR31UQ42KF1+V2AR31UQ42/5	AIR SUPPLY		1/17/2023	MKLEPADLO	
&MFS=V2AR31UQ42KF1+V2AR31UQ42/1	AIR SUPPLY		1/17/2023	MKLEPADLO	
&MFS=V2AR31UQ42UQ1+V2AR31UQ42/1	Common Clamps		1/17/2023	MKLEPADLO	
&MFS=V2AR31UQ42UQ2+V2AR31UQ42/1	L150 Model Clamps		1/17/2023	MKLEPADLO	
&MFS=V2AR31UQ42UQ3+V2AR31UQ42/1	L230/290/320 Model Clamps		1/17/2023	MKLEPADLO	
&MFS=V2AR31UQ42UQ4+V2AR31UQ42/1	Spare		12/20/2022	MKLEPADLO	
&MFS=V2AR31XQ41KF1+V2AR31KF1/5	AIR SUPPLY CONFIGURATION		1/17/2023	MKLEPADLO	
&MFS=V2AR31XQ41KF1+V2AR31KF1/11	AIR SUPPLY		1/17/2023	MKLEPADLO	
&MFS=V2AR31XQ41UQ1+V2AR31KF1/1	Cylinder		1/17/2023	MKLEPADLO	
&MFS=V2AR31XQ41UQ2+V2AR31KF1/1	Spare		12/20/2022	MKLEPADLO	
&MFS=V2AR32UQ41KF1+V2AR32UQ41/1	AIR SUPPLY GRIPPER		1/3/2023	MKLEPADLO	
&MFS=V2AR32UQ41KF1+V2AR32UQ41/5	AIR SUPPLY		1/17/2023	MKLEPADLO	
&MFS=V2AR32UQ41KF1+V2AR32UQ41/1	AIR SUPPLY		1/17/2023	MKLEPADLO	
&MFS=V2AR32UQ41UQ1+V2AR32UQ41/1	Common Shot Pin		1/17/2023	MKLEPADLO	

# Table of contents

Column X: An automatically generated page was edited

F06\_001

Page	Page description	supplementary page field	Date	Edited by	X
&MFS=V2AR32UQ41UQ2+V2AR32UQ41/	Common Clamps		1/17/2023	MKLEPADLO	
&MFS=V2AR32UQ41UQ3+V2AR32UQ41/	L230 Model Clamps		1/17/2023	MKLEPADLO	
&MFS=V2AR32UQ41UQ4+V2AR32UQ41/	L290 Model Shot Pin		1/17/2023	MKLEPADLO	
&MFS=V2AR32UQ41UQ5+V2AR32UQ41/	L290 Model Clamps		1/17/2023	MKLEPADLO	
&MFS=V2AR32UQ41UQ6+V2AR32UQ41/	L320 Model Shot Pin		1/17/2023	MKLEPADLO	
&MFS=V2AR32UQ41UQ7+V2AR32UQ41/	L320 Model Clamps		1/17/2023	MKLEPADLO	
&MFS=V2AR32UQ41UQ8+V2AR32UQ41/	Spare		12/20/2022	MKLEPADLO	
&MFS=V2AR32UQ42KF1+V2AR32UQ42/	AIR SUPPLY GRIPPER		1/3/2023	MKLEPADLO	
&MFS=V2AR32UQ42KF1+V2AR32UQ42/	AIR SUPPLY		1/17/2023	MKLEPADLO	
&MFS=V2AR32UQ42KF1+V2AR32UQ42/	AIR SUPPLY		1/17/2023	MKLEPADLO	
&MFS=V2AR32UQ42UQ1+V2AR32UQ42/	Common Clamps		1/17/2023	MKLEPADLO	
&MFS=V2AR32UQ42UQ2+V2AR32UQ42/	L150 Model Clamps		1/17/2023	MKLEPADLO	
&MFS=V2AR32XQ41KF1+V2AR32KF1/5	AIR SUPPLY CONFIGURATION		1/17/2023	MKLEPADLO	
&MFS=V2AR32XQ41KF1+V2AR32KF1/11	AIR SUPPLY		1/17/2023	MKLEPADLO	
&MFS=V2AR32XQ41UQ1+V2AR32KF1/1	Cylinder		12/20/2022	MKLEPADLO	
&MFS=V2AR32XQ41UQ2+V2AR32KF1/1	Spare		12/20/2022	MKLEPADLO	
&MFS=V2AR41UQ41KF1+V2AR41UQ41/	AIR SUPPLY GRIPPER		1/3/2023	MKLEPADLO	
&MFS=V2AR41UQ41KF1+V2AR41UQ41/	AIR SUPPLY		1/17/2023	MKLEPADLO	
&MFS=V2AR41UQ41KF1+V2AR41UQ41/	AIR SUPPLY		1/17/2023	MKLEPADLO	
&MFS=V2AR41UQ41UQ1+V2AR41UQ41/	L150 Model Shot Pins		1/17/2023	MKLEPADLO	
&MFS=V2AR41UQ41UQ2+V2AR41UQ41/	L150 Model Clamps 1		1/17/2023	MKLEPADLO	
&MFS=V2AR41UQ41UQ3+V2AR41UQ41/	Common Clamps		1/17/2023	MKLEPADLO	
&MFS=V2AR41UQ41UQ4+V2AR41UQ41/	L230/290/320 Model Clamps 1		1/17/2023	MKLEPADLO	
&MFS=V2AR41UQ41UQ5+V2AR41UQ41/	L230/290/320 Model Clamps 2		1/17/2023	MKLEPADLO	
&MFS=V2AR41UQ41UQ6+V2AR41UQ41/	Common Vacuums 1		12/20/2022	MKLEPADLO	
&MFS=V2AR41UQ41UQ7+V2AR41UQ41/	L150 Model Clamps 2		1/17/2023	MKLEPADLO	
&MFS=V2AR41UQ41UQ8+V2AR41UQ41/	Common Vacuums 2		12/20/2022	MKLEPADLO	
&MFS=V2AR42UQ41KF1+V2AR42UQ41/	AIR SUPPLY GRIPPER		1/3/2023	MKLEPADLO	
&MFS=V2AR42UQ41KF1+V2AR42UQ41/	AIR SUPPLY		1/17/2023	MKLEPADLO	
&MFS=V2AR42UQ41KF1+V2AR42UQ41/	AIR SUPPLY		1/17/2023	MKLEPADLO	
&MFS=V2AR42UQ41UQ1+V2AR42UQ41/	L150 Model Clamps		1/17/2023	MKLEPADLO	
&MFS=V2AR42UQ41UQ2+V2AR42UQ41/	Spare		12/20/2022	MKLEPADLO	
&MFS=V2AR42UQ42KF1+V2AR42UQ42/	AIR SUPPLY GRIPPER		1/3/2023	MKLEPADLO	

3

5



# Table of contents

Column X: An automatically generated page was edited

F06\_001

Page	Page description	supplementary page field	Date	Edited by	X
&MFS=V2AR42UQ42KF1+V2AR42UQ42/5	AIR SUPPLY		1/17/2023	MKLEPADLO	
&MFS=V2AR42UQ42KF1+V2AR42UQ42/1	AIR SUPPLY		1/17/2023	MKLEPADLO	
&MFS=V2AR42UQ42UQ1+V2AR42UQ42/1	L230/290/320 Model Clamps		1/17/2023	MKLEPADLO	
&MFS=V2AR42UQ42UQ2+V2AR42UQ42/5	Spare		12/20/2022	MKLEPADLO	
&MFS=V2AR43UQ41KF1+V2AR43UQ41/1	AIR SUPPLY GRIPPER		1/3/2023	MKLEPADLO	
&MFS=V2AR43UQ41KF1+V2AR43UQ41/5	AIR SUPPLY		1/17/2023	MKLEPADLO	
&MFS=V2AR43UQ41KF1+V2AR43UQ41/1	AIR SUPPLY		1/17/2023	MKLEPADLO	
&MFS=V2AR43UQ41UQ1+V2AR43UQ41/1	L150 Model Shot Pins		1/17/2023	MKLEPADLO	
&MFS=V2AR43UQ41UQ2+V2AR43UQ41/1	L150 Model Clamps 1		1/17/2023	MKLEPADLO	
&MFS=V2AR43UQ41UQ3+V2AR43UQ41/1	L150 Model Vacuums		12/20/2022	MKLEPADLO	
&MFS=V2AR43UQ41UQ4+V2AR43UQ41/1	L150 Model Clamps 2		1/17/2023	MKLEPADLO	
&MFS=V2AR43UQ42KF1+V2AR43UQ42/1	AIR SUPPLY GRIPPER		1/3/2023	MKLEPADLO	
&MFS=V2AR43UQ42KF1+V2AR43UQ42/5	AIR SUPPLY		1/17/2023	MKLEPADLO	
&MFS=V2AR43UQ42KF1+V2AR43UQ42/1	AIR SUPPLY		1/17/2023	MKLEPADLO	
&MFS=V2AR43UQ42UQ1+V2AR43UQ42/1	L290/320 Model Shot Pin		1/17/2023	MKLEPADLO	
&MFS=V2AR43UQ42UQ2+V2AR43UQ42/1	L290 Model Clamps 1		1/17/2023	MKLEPADLO	
&MFS=V2AR43UQ42UQ3+V2AR43UQ42/1	L290/320 Model Vacuums		12/20/2022	MKLEPADLO	
&MFS=V2AR43UQ42UQ4+V2AR43UQ42/1	L290/320 Model Clamps 1		1/17/2023	MKLEPADLO	
&MFS=V2AR43UQ42UQ5+V2AR43UQ42/1	L290 Model Clamps 2		1/17/2023	MKLEPADLO	
&MFS=V2AR43UQ42UQ6+V2AR43UQ42/1	L290/320 Model Clamps 2		1/17/2023	MKLEPADLO	
&MFS=V2AR43UQ42UQ7+V2AR43UQ42/1	L290 Model Clamps 3		1/17/2023	MKLEPADLO	
&MFS=V2AR43UQ42UQ8+V2AR43UQ42/1	L320 Model Clamps 1		1/17/2023	MKLEPADLO	
&MFS=V2AR43UQ42UQ9+V2AR43UQ42/1	L320 Model Clamps 2		1/17/2023	MKLEPADLO	
&MFS=V2AR43UQ42UQ10+V2AR43UQ42/5	Spare		12/20/2022	MKLEPADLO	
&MFS=V2AR43UQ43KF1+V2AR43UQ43/1	AIR SUPPLY GRIPPER		1/3/2023	MKLEPADLO	
&MFS=V2AR43UQ43KF1+V2AR43UQ43/5	AIR SUPPLY		1/17/2023	MKLEPADLO	
&MFS=V2AR43UQ43KF1+V2AR43UQ43/1	AIR SUPPLY		1/17/2023	MKLEPADLO	
&MFS=V2AR43UQ43UQ1+V2AR43UQ43/1	L230 Model Shot Pin		1/17/2023	MKLEPADLO	
&MFS=V2AR43UQ43UQ2+V2AR43UQ43/1	L230 Model Clamps 1		1/17/2023	MKLEPADLO	
&MFS=V2AR43UQ43UQ3+V2AR43UQ43/1	L230 Model Vacuums		12/20/2022	MKLEPADLO	
&MFS=V2AR43UQ43UQ4+V2AR43UQ43/1	L230 Model Clamps 2		1/17/2023	MKLEPADLO	
&MFS=V2AR44UQ41KF1+V2AR44UQ41/1	AIR SUPPLY GRIPPER		1/3/2023	MKLEPADLO	
&MFS=V2AR44UQ41KF1+V2AR44UQ41/5	AIR SUPPLY		1/17/2023	MKLEPADLO	



# Table of contents

Column X: An automatically generated page was edited

F06\_001

Page	Page description	supplementary page field	Date	Edited by	X
&MFS=V2GL16UQ51KF2+V2GL16UQ51/5	AIR SUPPLY CONFIGURATION		1/17/2023	MKLEPADLO	
&MFS=V2GL16UQ51KF2+V2GL16UQ51/1	AIR SUPPLY		1/17/2023	MKLEPADLO	
&MFS=V2GL16UQ51UQ3+V2GL16UQ51/	Pallet Stop Station #3 Pre-Unload		1/17/2023	MKLEPADLO	
&MFS=V2GL16UQ51UQ4+V2GL16UQ51/	Pallet Stop Station #4 Unload		12/20/2022	MKLEPADLO	
&MFS=V2GL16UQ51UQ5+V2GL16UQ51/	Pallet Stop Station #5 Mid-Stop #2		1/17/2023	MKLEPADLO	
&MFS=V2GL16UQ51UQ8+V2GL16UQ51/	Spare QN4		12/20/2022	MKLEPADLO	
&MFS=V2GL17+KH1/1	Incoming air supply (Conveyor)		12/20/2022	MKLEPADLO	
&MFS=V2GL17UQ51KF2+V2GL17UQ51/5	AIR SUPPLY CONFIGURATION		1/18/2023	MKLEPADLO	
&MFS=V2GL17UQ51KF2+V2GL17UQ51/1	AIR SUPPLY		1/18/2023	MKLEPADLO	
&MFS=V2GL17UQ51UQ3+V2GL17UQ51/	Pallet Stop Station #3 Pre-Unload		1/18/2023	MKLEPADLO	
&MFS=V2GL17UQ51UQ4+V2GL17UQ51/	Pallet Stop Station #4 Unload		12/20/2022	MKLEPADLO	
&MFS=V2GL17UQ51UQ5+V2GL17UQ51/	Pallet Stop Station #5 Mid-Stop #2		1/18/2023	MKLEPADLO	
&MFS=V2GL17UQ51UQ8+V2GL17UQ51/	Spare QN4		12/20/2022	MKLEPADLO	
&MFS=V2GL18+KH1/1	Incoming air supply (Conveyor)		12/20/2022	MKLEPADLO	
&MFS=V2GL18UQ51KF2+V2GL18UQ51/5	AIR SUPPLY CONFIGURATION		1/18/2023	MKLEPADLO	
&MFS=V2GL18UQ51KF2+V2GL18UQ51/1	AIR SUPPLY		1/18/2023	MKLEPADLO	
&MFS=V2GL18UQ51UQ3+V2GL18UQ51/	Pallet Stop Station #3 Pre-Unload		1/18/2023	MKLEPADLO	
&MFS=V2GL18UQ51UQ4+V2GL18UQ51/	Pallet Stop Station #4 Unload		12/20/2022	MKLEPADLO	
&MFS=V2GL18UQ51UQ5+V2GL18UQ51/	Pallet Stop Station #5 Mid-Stop #2		1/18/2023	MKLEPADLO	
&MFS=V2GL18UQ51UQ8+V2GL18UQ51/	Spare QN4		12/20/2022	MKLEPADLO	
&MFS=V2UQ31+KH1/1	Incoming air supply (Fixture)		12/20/2022	MKLEPADLO	
&MFS=V2UQ31KF1+V2UQ31/5	AIR SUPPLY CONFIGURATION		1/18/2023	MKLEPADLO	
&MFS=V2UQ31KF1+V2UQ31/11	AIR SUPPLY		1/18/2023	MKLEPADLO	
&MFS=V2UQ31KF2+V2UQ31/5	AIR SUPPLY CONFIGURATION		1/18/2023	MKLEPADLO	
&MFS=V2UQ31KF2+V2UQ31/11	AIR SUPPLY		1/18/2023	MKLEPADLO	
&MFS=V2UQ31UQ1+V2UQ31/1	LH Common Clamps 1		12/20/2022	MKLEPADLO	
&MFS=V2UQ31UQ2+V2UQ31/1	LH Common Clamp 2		12/20/2022	MKLEPADLO	
&MFS=V2UQ31UQ3+V2UQ31/1	LH Common Clamp 3		12/20/2022	MKLEPADLO	
&MFS=V2UQ31UQ4+V2UQ31/1	LH L150 Model Clamp 1		12/20/2022	MKLEPADLO	
&MFS=V2UQ31UQ5+V2UQ31/1	LH L150 Model Clamp 2		12/20/2022	MKLEPADLO	
&MFS=V2UQ31UQ6+V2UQ31/1	LH L150 Model Clamp 3		12/20/2022	MKLEPADLO	
&MFS=V2UQ31UQ7+V2UQ31/1	LH L230/290/320 Model Clamp 1		12/20/2022	MKLEPADLO	
&MFS=V2UQ31UQ8+V2UQ31/1	LH L230/290/320 Model Clamp 2		12/20/2022	MKLEPADLO	

Date	1/18/2023	Volvo Trucks North America		Valiant TMS	Table of contents : &MFS=V2GL16UQ51KF2+V2GL16UQ51/5 - &MFS=V2UQ31UQ8+V2UQ31/1	Drawing name:	=	=2V01&MFS-PNEU_KF1	Project nr: 22-16152	Page 7
Ed.	MKLEPADLO	P6700 Framing - Cell 2V01, KF1		Scale 1:1		Document type:	MAB			
Modification	Date	Name	Original	Replacement of	Replaced by					









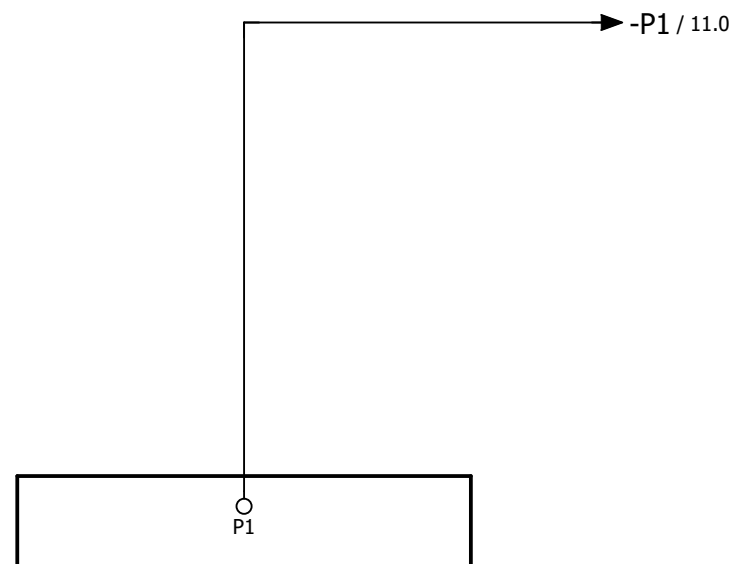

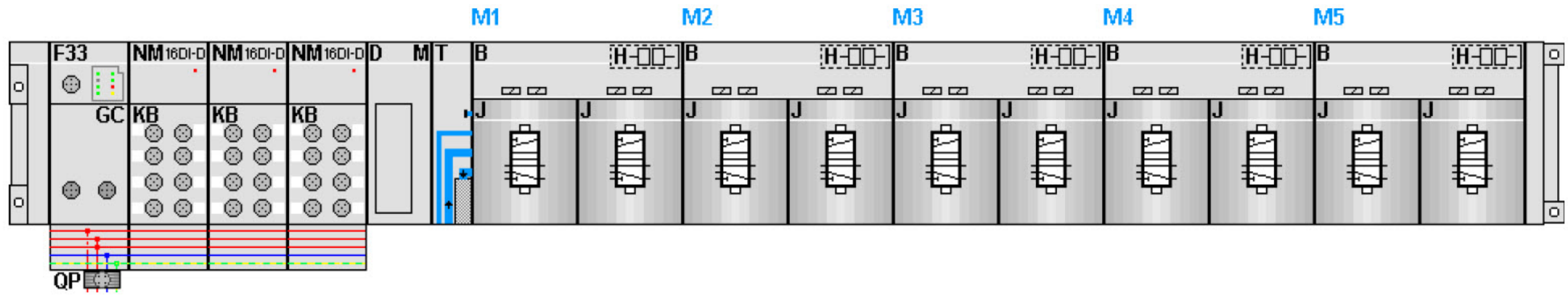

=KH0+KH0/1

		Date	1/3/2023	Volvo Trucks North America			Valiant TMS	AIR SUPPLY GRIPPER	Drawing name:		= V1AR11UQ41KF1
		Ed.	MKLEPADLO	P6700 Framing - Cell 2V01, KF1					=2V01&MFS-PNEU_KF1		+ V1AR11UQ41
Modification	Date	Name	Original	Replacement of	Replaced by		Scale 1:1		Document type:	Project nr:	Page
									MFS	22-16152	1
											275

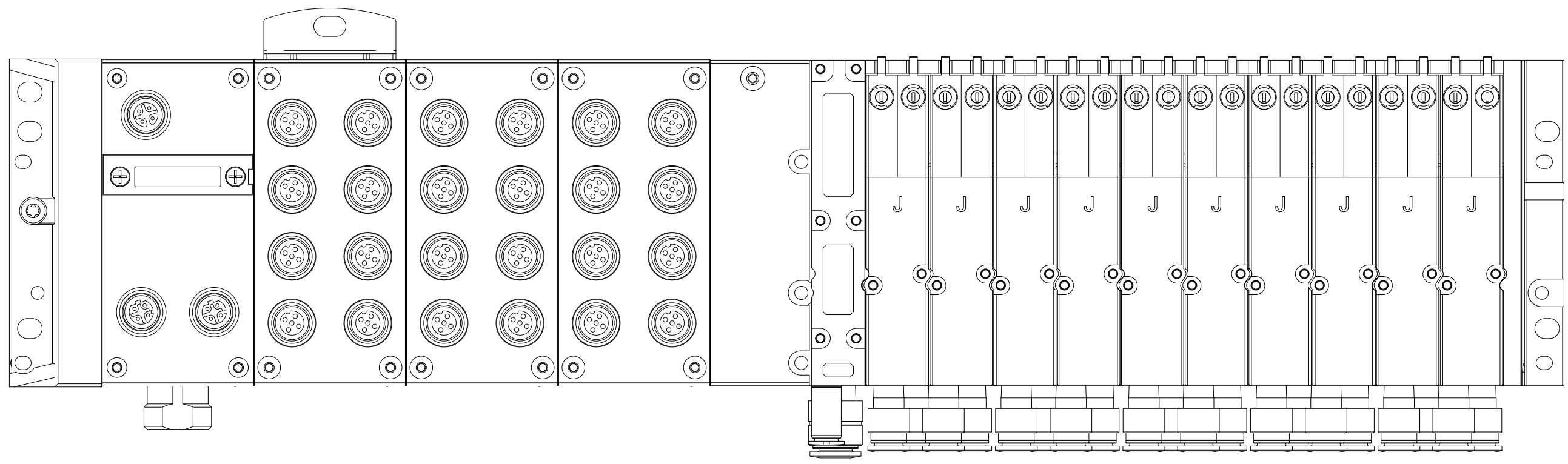

KF1.0



		Date	1/4/2023	Volvo Trucks North America			Valiant TMS	AIR SUPPLY	Drawing name:		= V1AR11UQ41KF1
		Ed.	MKLEPADLO	P6700 Framing - Cell 2V01, KF1					=2V01&MFS-PNEU_KF1		+ V1AR11UQ41
		Appr		Replacement of		Replaced by	Scale 1:1		Document type:	Project nr:	Page
Modification	Date	Name	Original						MFS	22-16152	5
											275



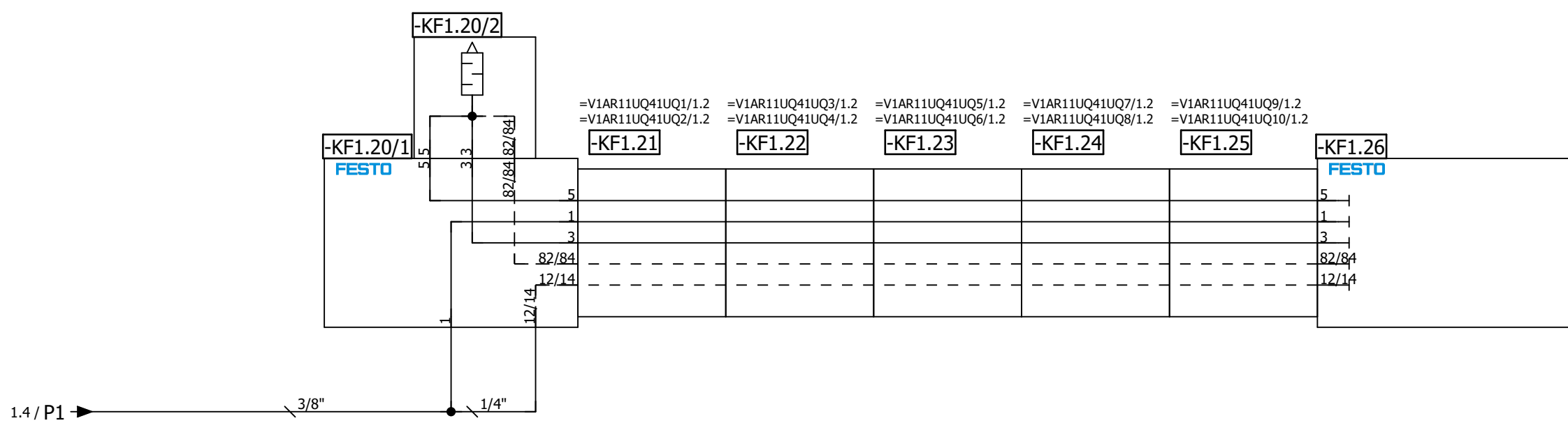
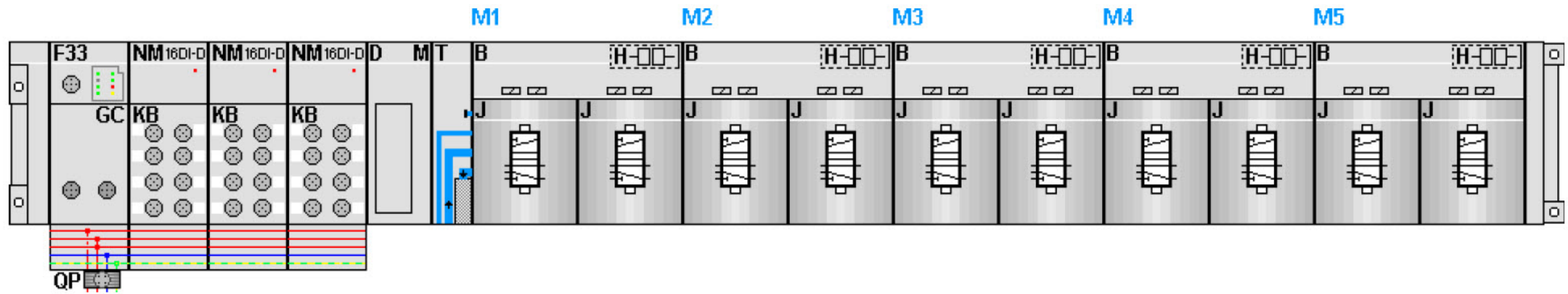

Date		1/3/2023	Volvo Trucks North America		Valiant TMS	AIR SUPPLY	Drawing name:		= V1AR11UQ41KF1				
Ed.		MKLEPADLO	P6700 Framing - Cell 2V01, KF1				=2V01&MFS-PNEU_KF1		+ V1AR11UQ41				
Appr			Replacement of		Scale 1:1	Document type:		MFS	Project nr:	22-16152	Page	11	
Original			Replaced by			MFS		22-16152		Page		11	
Modification	Date	Name	Original	Replacement of	Replaced by	Scale 1:1		MFS		Page		11	
											Page		275



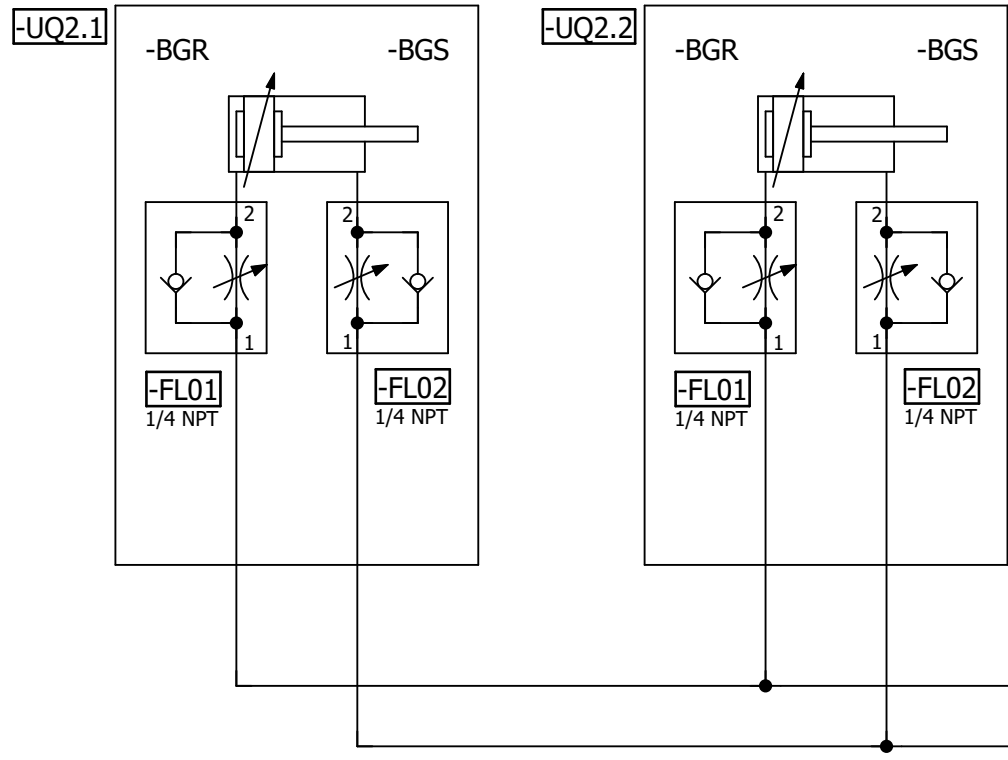

=V1AR11UQ41KF1

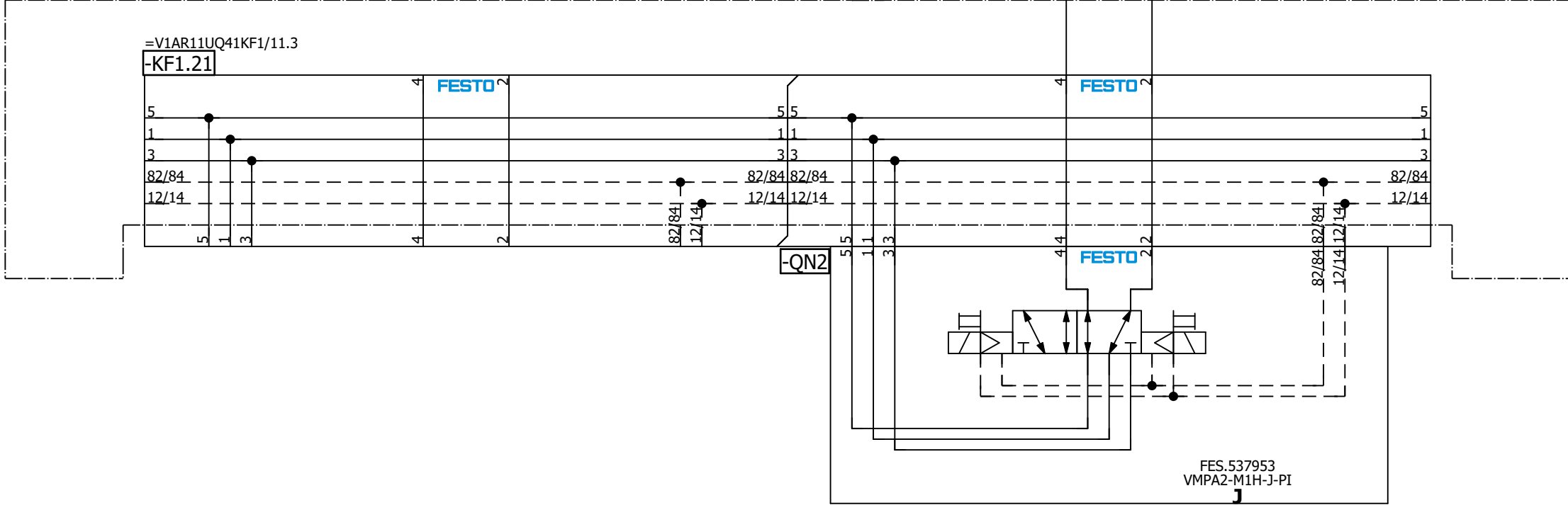

=V1AR11UQ41  
-UQ2-QN2.1  
L150 Model  
Clamps (RST)

=V1AR11UQ41  
-UQ2-QN2.2  
L150 Model  
Clamps (SET)

=V1AR11UQ41UQ3/1

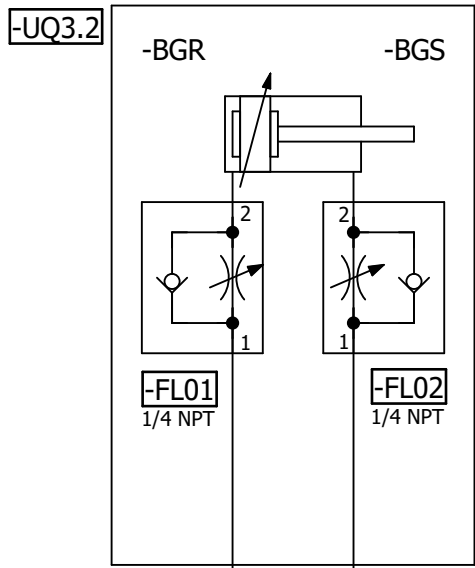
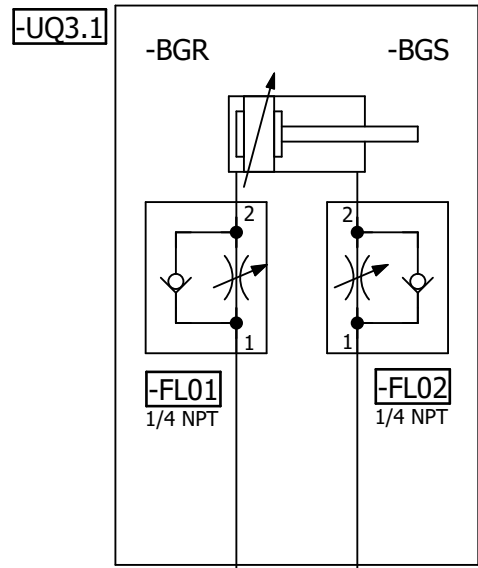

=V1AR11UQ41KF1

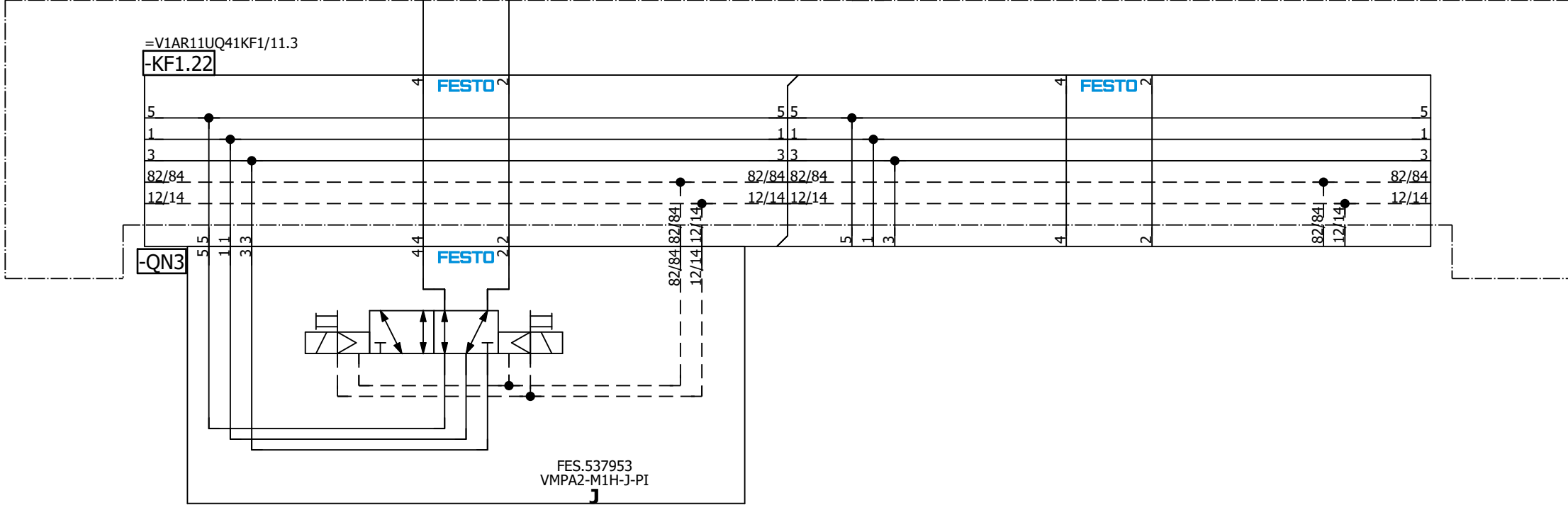

=V1AR11UQ41  
-UQ3-QN3.1  
L230 Model  
Clamps (RST)

=V1AR11UQ41  
-UQ3-QN3.2  
L230 Model  
Clamps (SET)

=V1AR11UQ41UQ2/1

=V1AR11UQ41UQ4/1

		Date	1/17/2023	Volvo Trucks North America		Valiant TMS		L230 Model Clamps		Drawing name: =2V01&MFS-PNEU_KF1		= V1AR11UQ41UQ3	
		Ed.	MKLEPADLO	P6700 Framing - Cell 2V01, KF1		Scale 1:1				Document type: MFS		Project nr: 22-16152	
Modification	Date	Name	Original	Replacement of	Replaced by							Page	1
													275







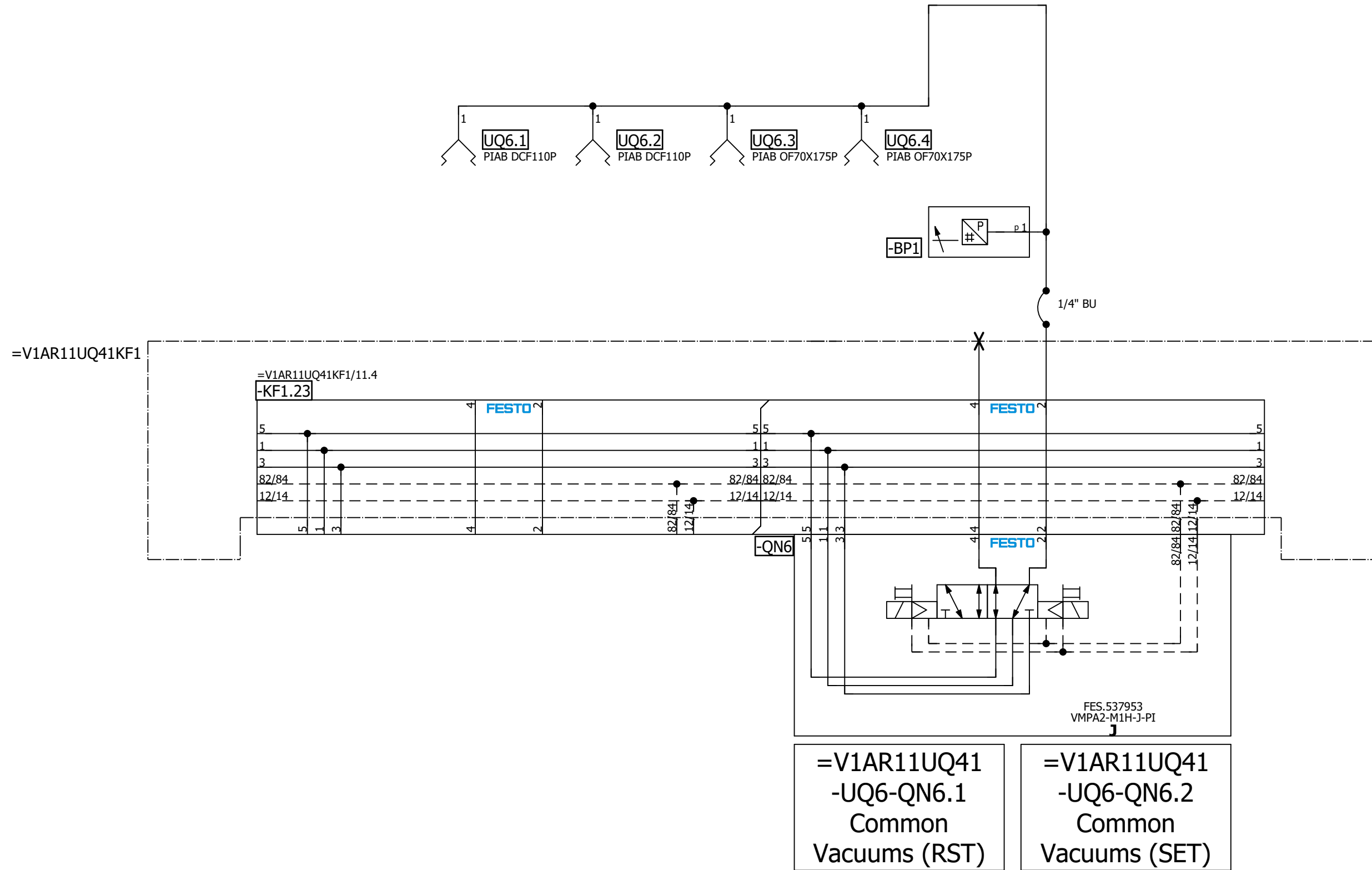

=V1AR11UQ41UQ5/1

Modification	Date	Name	Original

Date	12/15/2022
Ed.	MKLEPADLO
Appr.	
Original	

Volvo Trucks North America	Valiant TMS
P6700 Framing - Cell 2V01, KF1	Scale 1:1
Replacement of	Replaced by

Common Vacuums
----------------

Drawing name:	=2V01&MFS-PNEU_KF1
Document type:	MFS
Project nr:	22-16152

= V1AR11UQ41UQ6	Page	1
+ V1AR11UQ41		275

=V1AR11UQ41UQ7/1

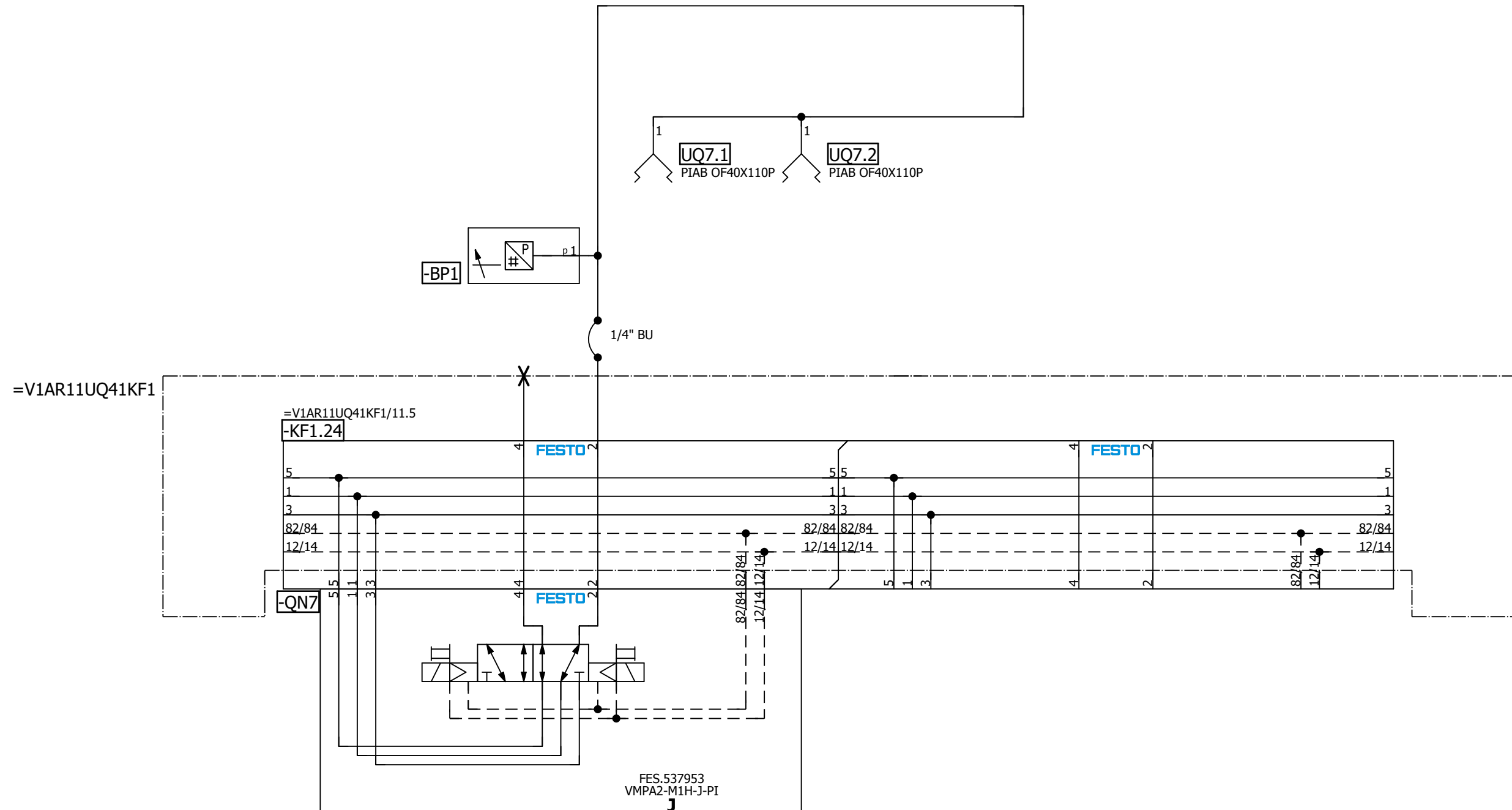

=V1AR11UQ41  
-UQ7-QN7.1  
L230 Model  
Vacuums (RST)

=V1AR11UQ41  
-UQ7-QN7.2  
L230 Model  
Vacuums (SET)

=V1AR11UQ41UQ6/1 =V1AR11UQ41UQ8/1

Date		12/15/2022		Volvo Trucks North America		Valiant TMS		L230 Model Vacuums		Drawing name:		= V1AR11UQ41UQ7	
Ed.		MKLEPADLO		P6700 Framing - Cell 2V01, KF1		Scale 1:1				Document type:		= 2V01&MFS-PNEU_KF1	
Appr.				Replacement of		Replaced by				Project nr:		+ V1AR11UQ41	
Modification		Date		Name		Original				MFS		22-16152	
											Page	1	
												275	

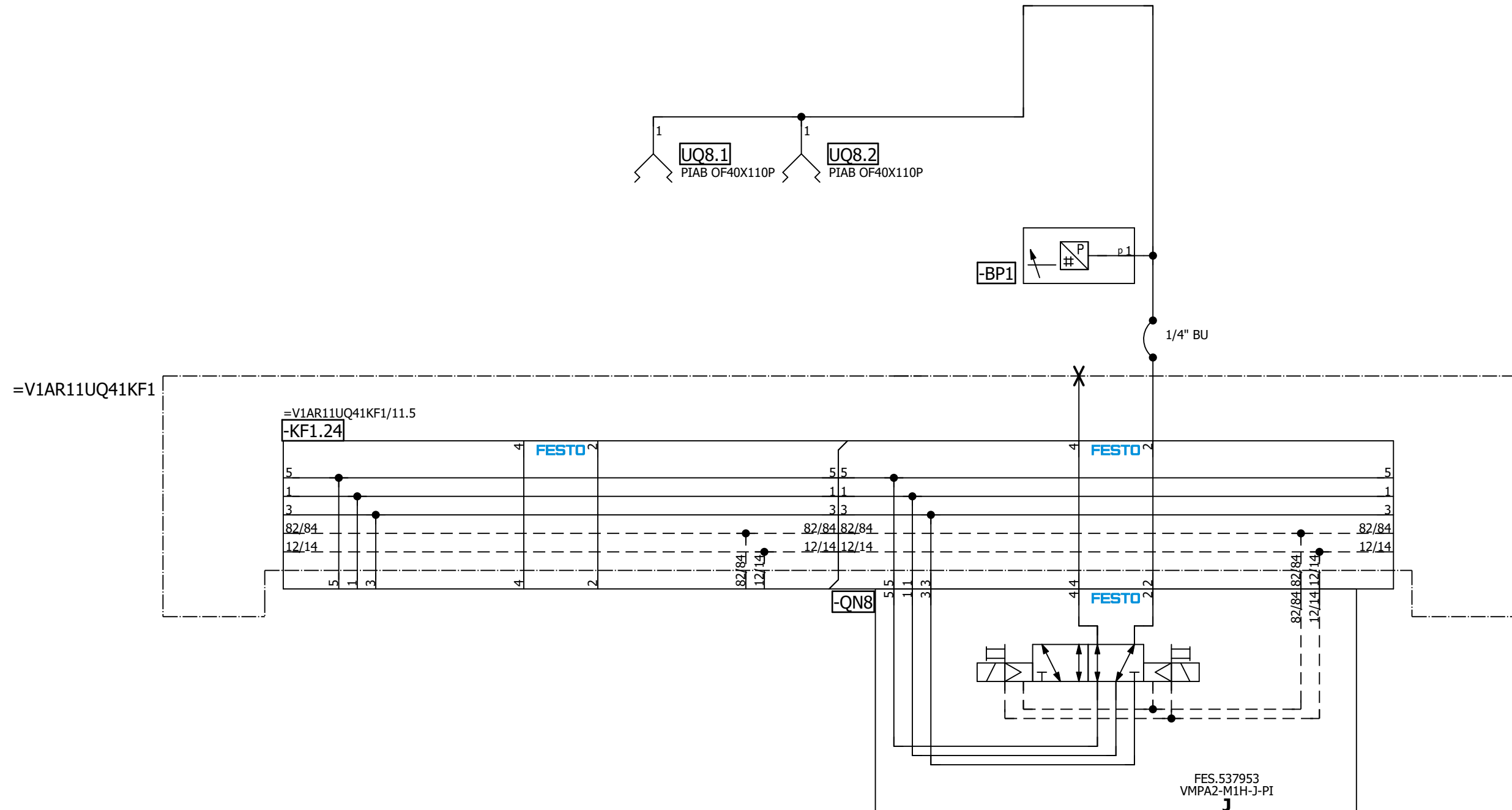

=V1AR11UQ41  
-UQ8-QN8.1  
L290 Model  
Vacuums (RST)

=V1AR11UQ41  
-UQ8-QN8.2  
L290 Model  
Vacuums (SET)

=V1AR11UQ41UQ7/1

=V1AR11UQ41UQ9/1

Date		12/15/2022		Volvo Trucks North America		Valiant TMS		L290 Model Vacuums		Drawing name:		= V1AR11UQ41UQ8	
Ed.		MKLEPADLO		P6700 Framing - Cell 2V01, KF1		Scale 1:1				=2V01&MFS-PNEU_KF1		+ V1AR11UQ41	
Appr.				Replacement of		Replaced by				Document type:		Project nr:	
Original										MFS		22-16152	
Modification		Date		Name		Original						Page	
												1	
												275	



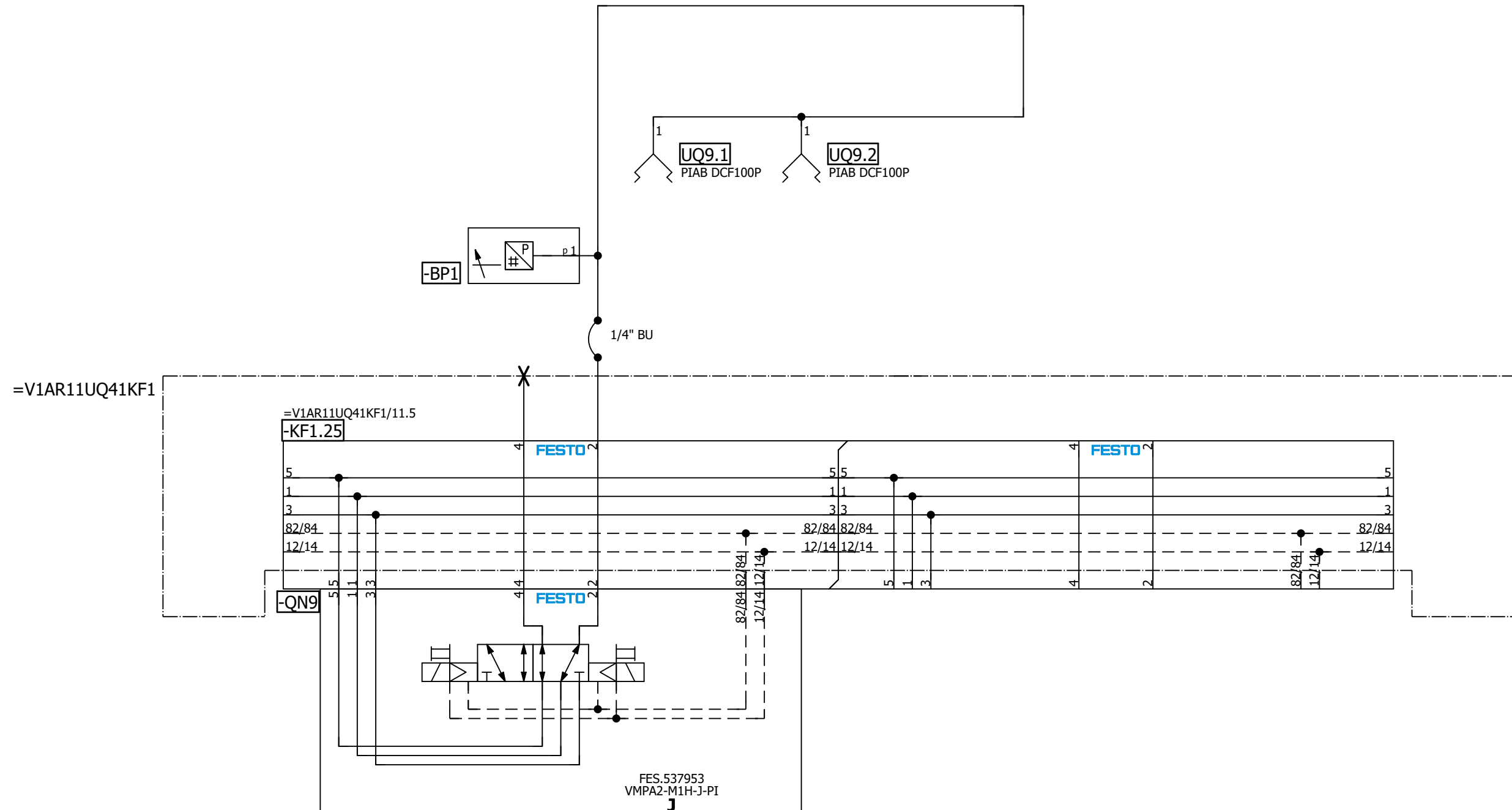

=V1AR11UQ41  
-UQ9-QN9.1  
L320 Model  
Vacuums (RST)

=V1AR11UQ41  
-UQ9-QN9.2  
L320 Model  
Vacuums (SET)

=V1AR11UQ41UQ8/1

=V1AR11UQ41UQ10/1

Date		12/15/2022		Volvo Trucks North America		Valiant TMS		L320 Model Vacuums		Drawing name:		= V1AR11UQ41UQ9	
Ed.		MKLEPADLO		P6700 Framing - Cell 2V01, KF1		Scale 1:1				Document type:		= 2V01&MFS-PNEU_KF1	
Appr.				Replacement of		Replaced by				Project nr:		+ V1AR11UQ41	
Modification		Date		Name		Original				MFS		22-16152	
											Page	1	
												275	



=V1AR11UQ41KF1

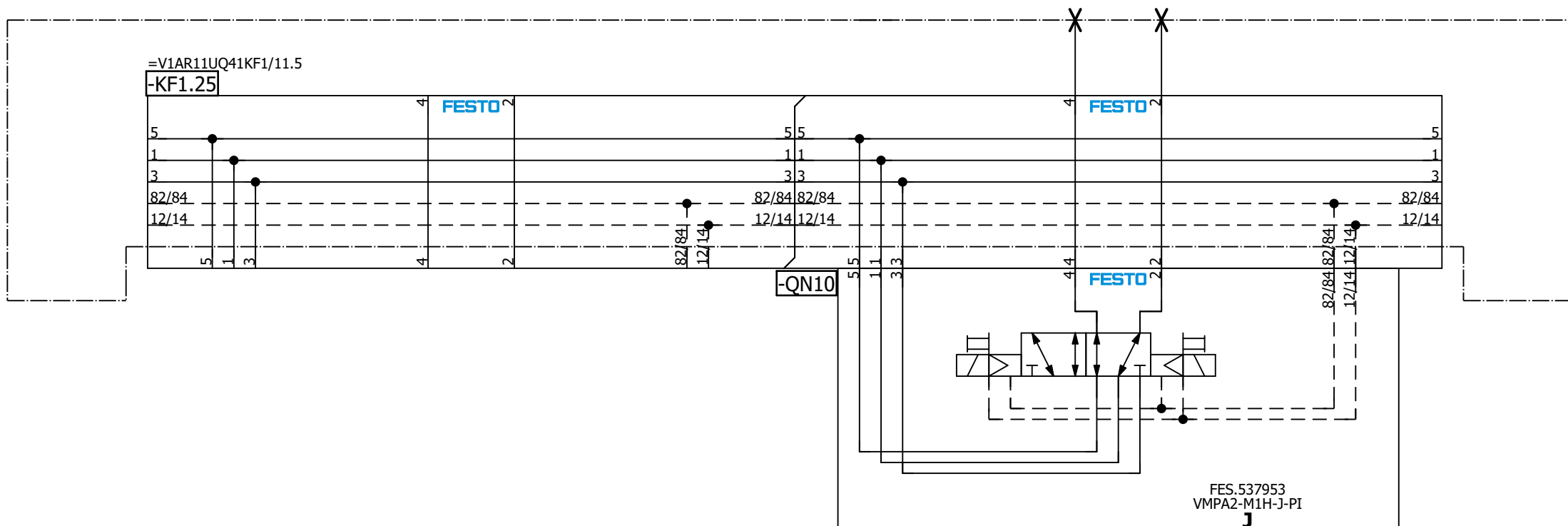

=V1AR11UQ41  
-UQ10-QN10.1  
Spare  
(RST)

=V1AR11UQ41  
-UQ10-QN10.2  
Spare  
(SET)

=V1AR31UQ41KF1+.AR31UQ41/1

=V1AR11UQ41UQ9/1

Date		12/15/2022		Volvo Trucks North America		Valiant TMS		Spare		Drawing name:		= V1AR11UQ41UQ10	
Ed.		MKLEPADLO		P6700 Framing - Cell 2V01, KF1		Scale 1:1				Document type:		+ V1AR11UQ41	
Appr.				Replacement of		Replaced by				Project nr:		Page	
Original										22-16152		1	
Modification		Date		Name		Original				MFS		275	

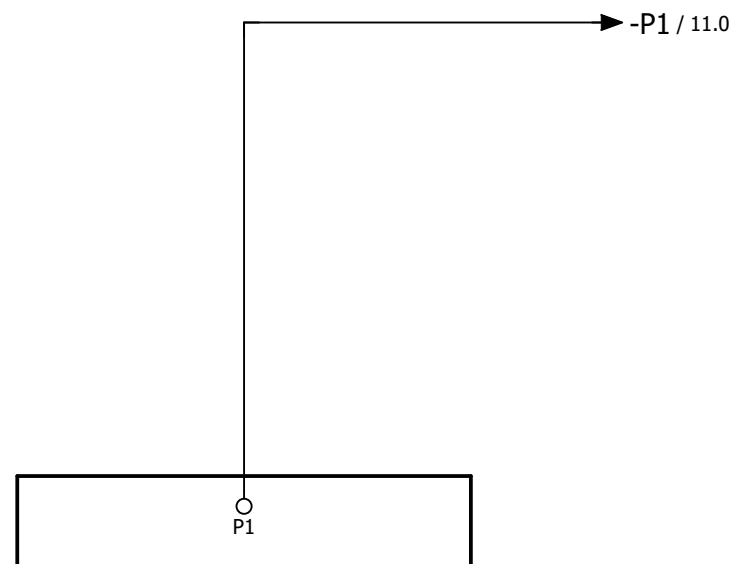

=V1AR11UQ41UQ10+.AR11UQ41/1

		Date	1/3/2023	Volvo Trucks North America		Valiant TMS	AIR SUPPLY GRIPPER	Drawing name:		= V1AR31UQ41KF1
		Ed.	MKLEPADLO	P6700 Framing - Cell 2V01, KF1				=2V01&MFS-PNEU_KF1		+ V1AR31UQ41
Modification	Date	Name	Original	Replacement of	Replaced by	Scale 1:1		Document type:	Project nr:	Page
								MFS	22-16152	1
										275

M1

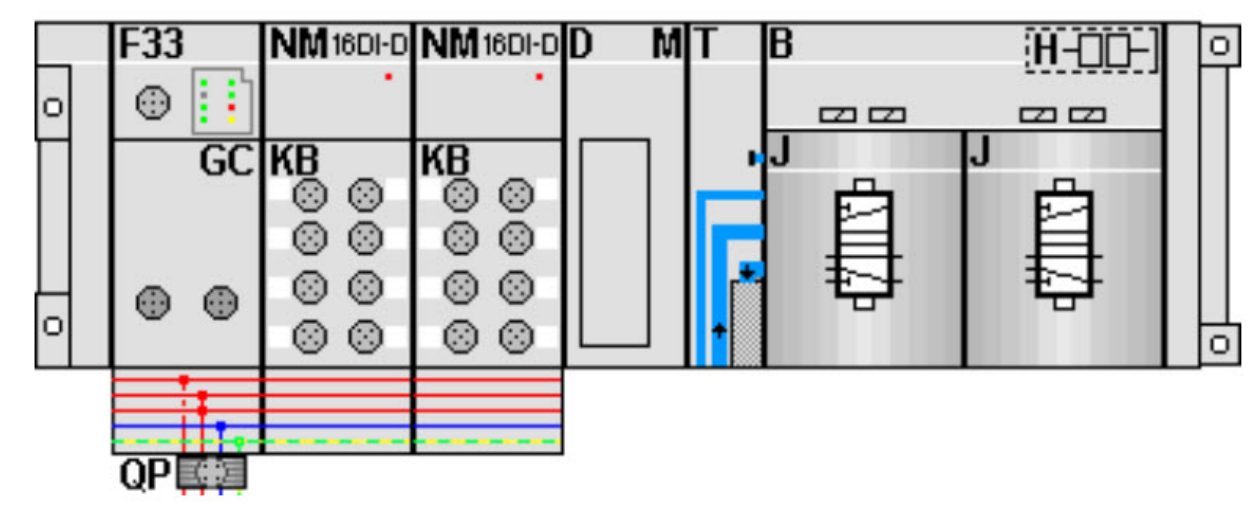

KF1.0

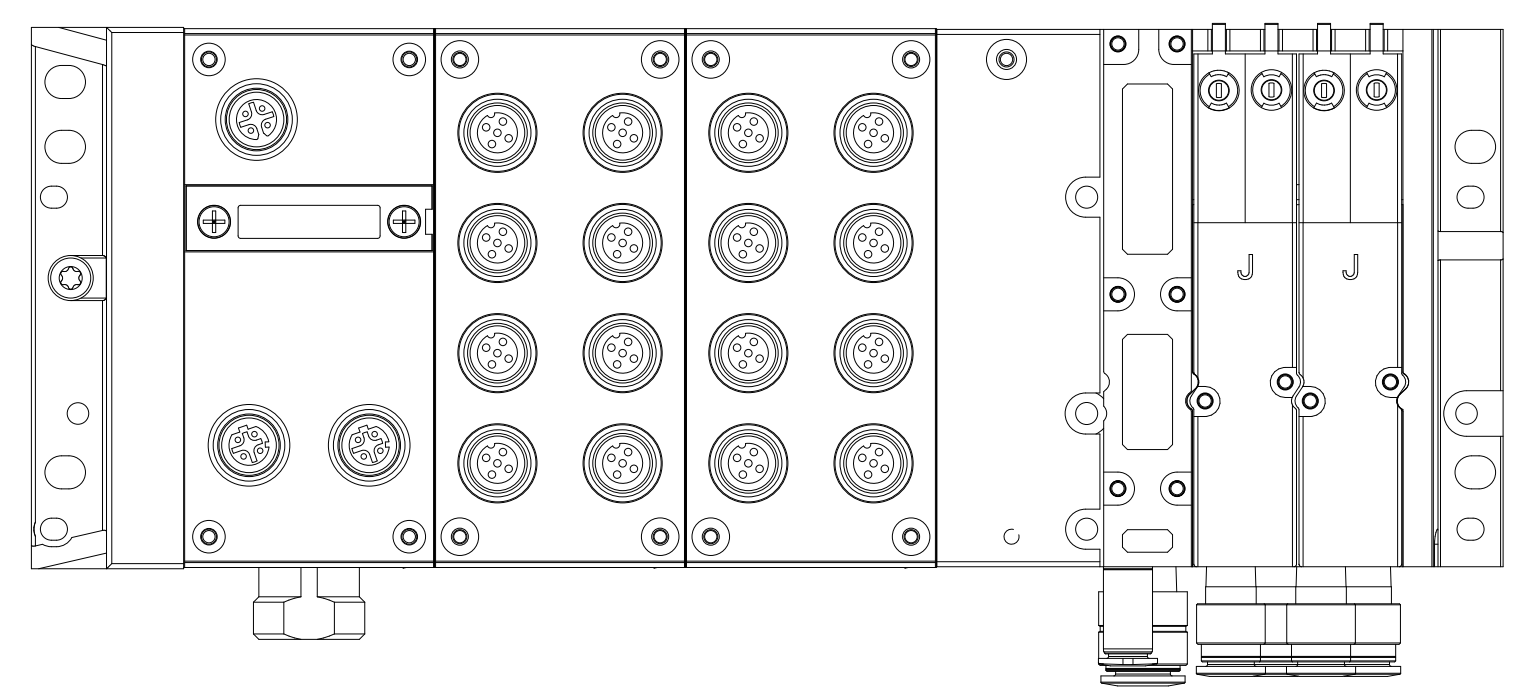

		Date	1/17/2023	Volvo Trucks North America			Valiant TMS	AIR SUPPLY	Drawing name:		= V1AR31UQ41KF1
		Ed.	MKLEPADLO	P6700 Framing - Cell 2V01, KF1			Scale 1:1		=2V01&MFS-PNEU_KF1		+ V1AR31UQ41
Modification	Date	Name	Original	Replacement of	Replaced by			Document type:	Project nr:		Page
								MFS	22-16152		5
											275







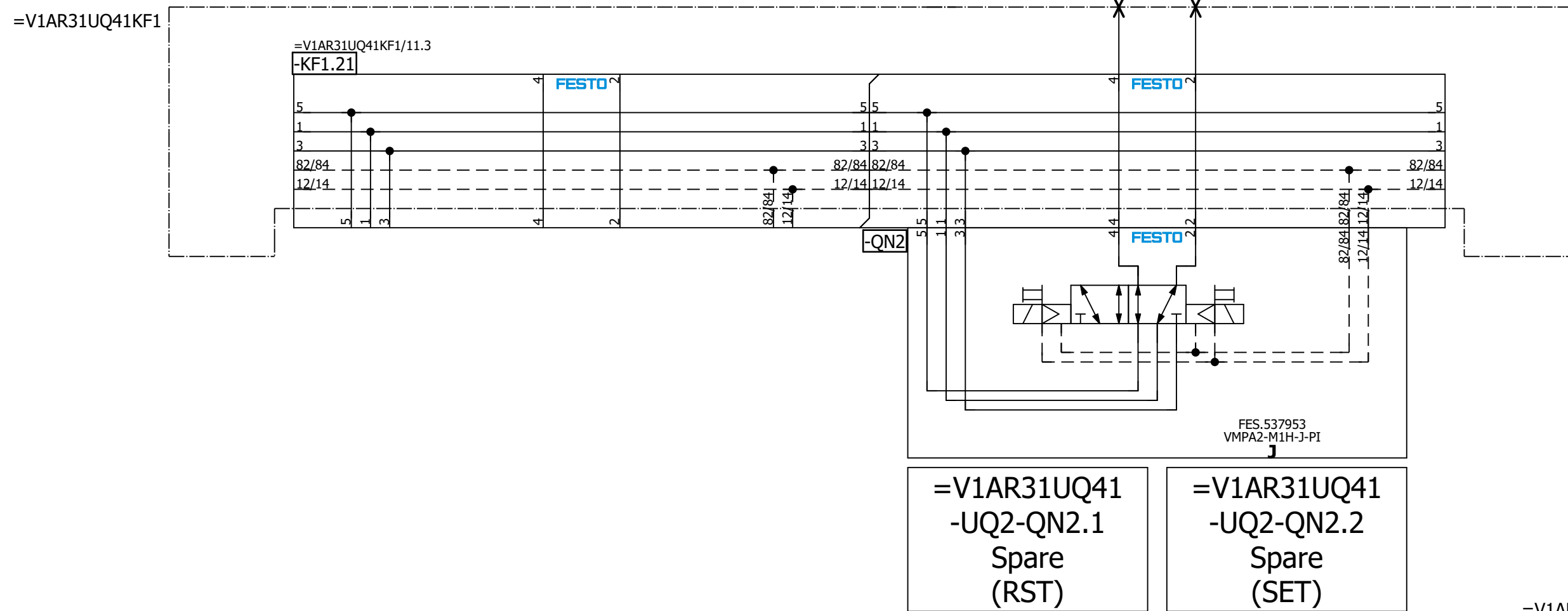

=V1AR31UQ41UQ1/1

=V1AR31XQ41KF1+.AR31KF1/5

Date		12/15/2022		Volvo Trucks North America		Valiant TMS		Spare		Drawing name:		= V1AR31UQ41UQ2	
Ed.		MKLEPADLO		P6700 Framing - Cell 2V01, KF1		Scale 1:1				Document type:		= V1AR31UQ41	
Appr.				Replacement of		Replaced by				Project nr:		Page	
Original										22-16152		1	
Modification		Date		Name		Original				MFS		275	



M1

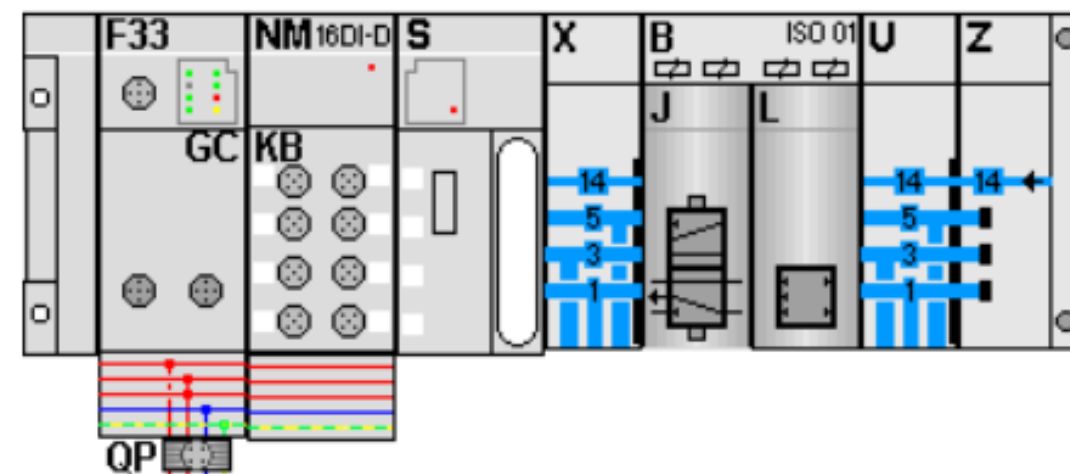

KF1.0

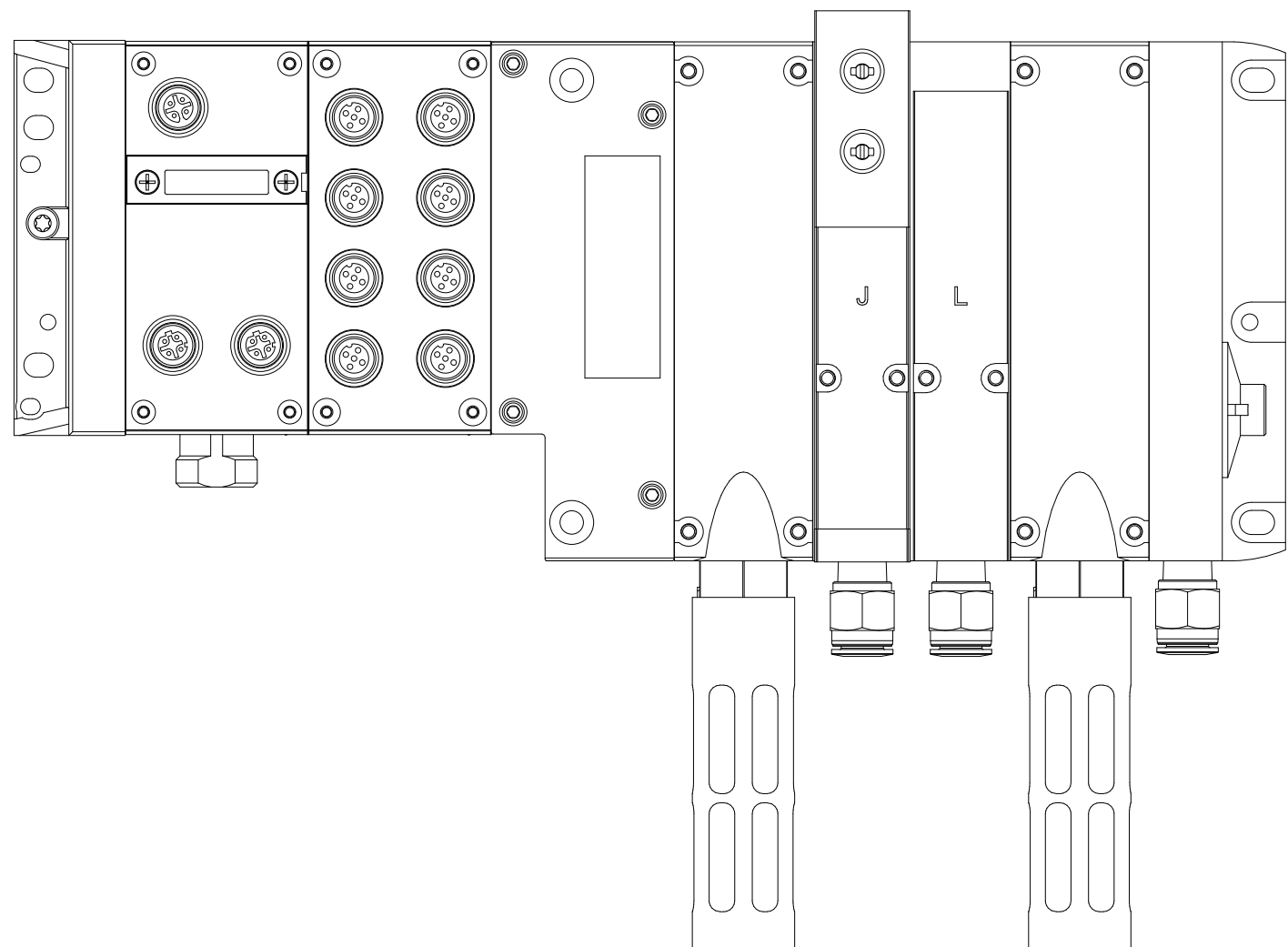

=V1AR31UQ41UQ2+.AR31UQ41/1

		Date	1/17/2023	Volvo Trucks North America			Valiant TMS	AIR SUPPLY CONFIGURATION	Drawing name: =2V01&MFS-PNEU_KF1		= V1AR31XQ41KF1
		Ed.	MKLEPADLO	P6700 Framing - Cell 2V01, KF1					Document type: MFS		Project nr: 22-16152
Modification	Date	Name	Original	Replacement of	Replaced by	Scale 1:1					Page 5
											275

M1

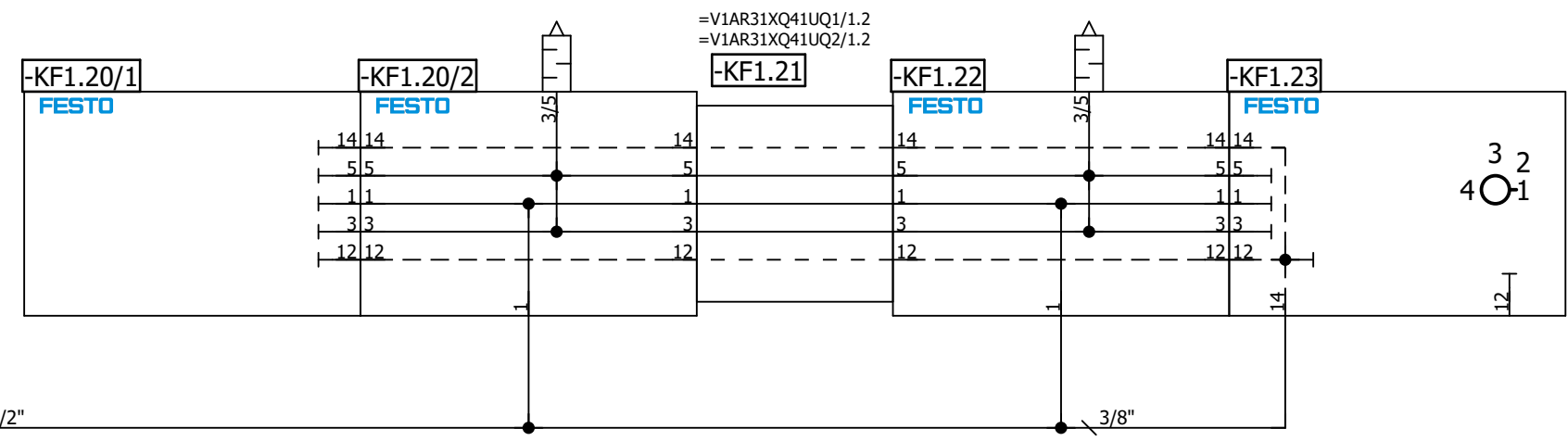
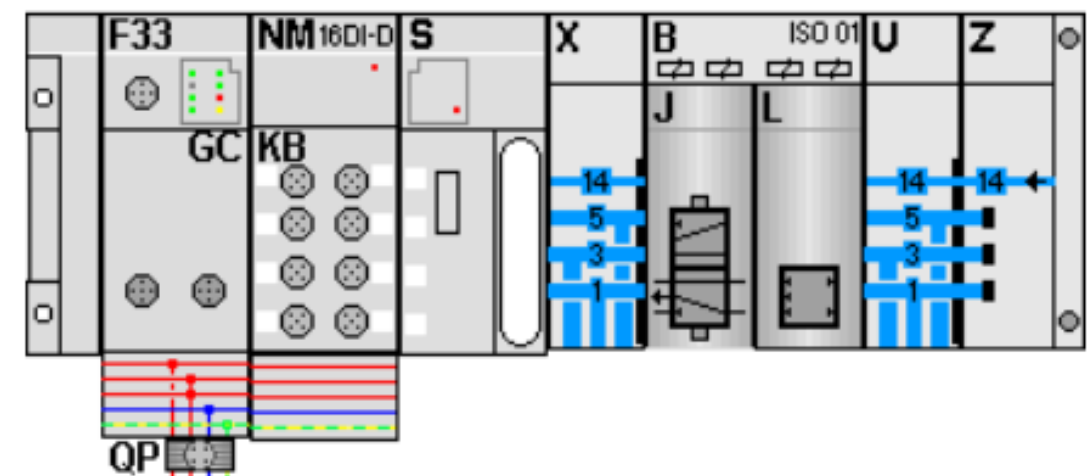

=KH0+KH0/1.5 / +KH0-V1AR31XQ41

1/2"

3/8"

=V1AR31XQ41UQ1/1.2  
=V1AR31XQ41UQ2/1.2

5

=V1AR31XQ41UQ1/1

Date	1/17/2023	Volvo Trucks North America	Valiant TMS	AIR SUPPLY	Drawing name:	= V1AR31XQ41KF1
Ed.	MKLEPADLO	P6700 Framing - Cell 2V01, KF1			Document type:	MFS
Appr.		Replacement of	Replaced by	Scale 1:1		Page 11
Modification	Date	Name	Original			275

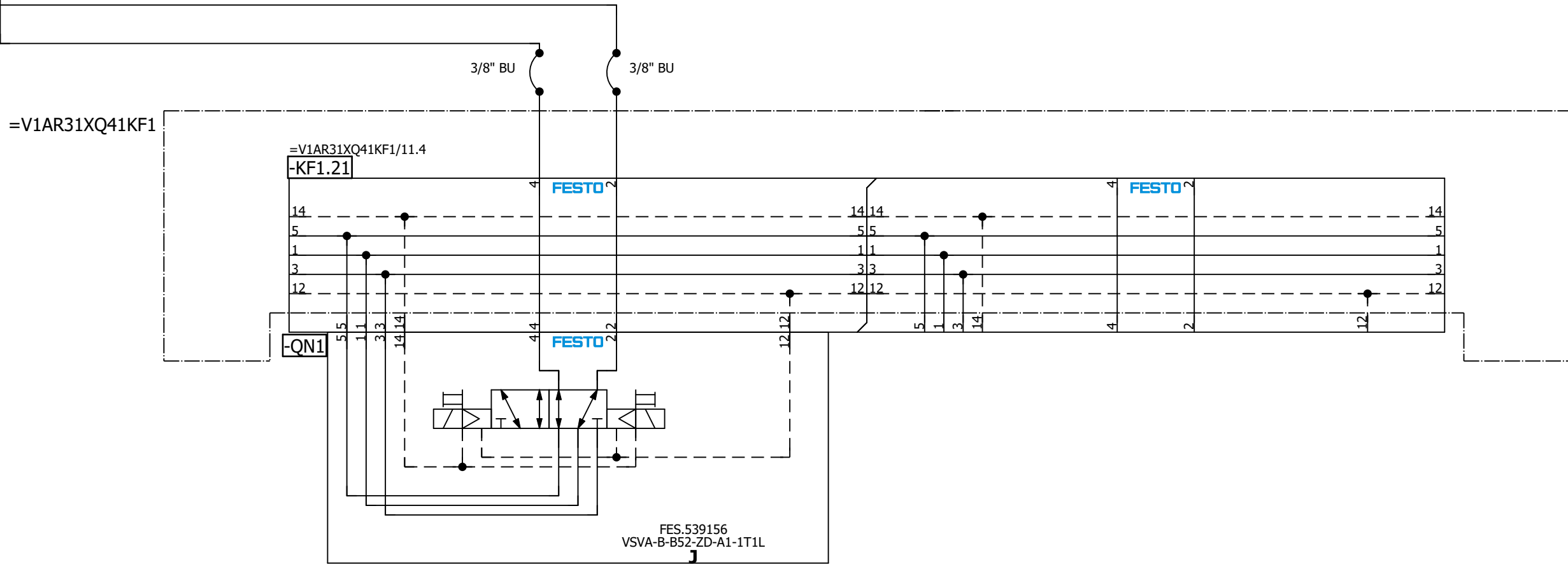
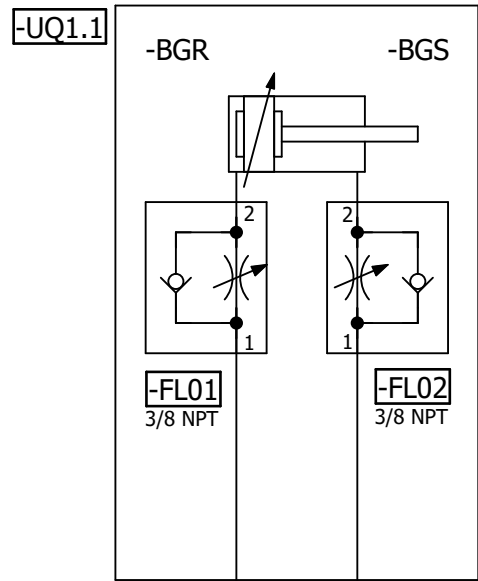

=V1AR31XQ41  
-UQ1-QN1.1  
Cylinder  
(RST)

=V1AR31XQ41  
-UQ1-QN1.2  
Cylinder  
(SET)

=V1AR31XQ41KF1/11

=V1AR31XQ41UQ2/1

Date		1/17/2023	Volvo Trucks North America		Valiant TMS	Cylinder	Drawing name:		= V1AR31XQ41UQ1
Ed.		MKLEPADLO	P6700 Framing - Cell 2V01, KF1				=2V01&MFS-PNEU_KF1		+ V1AR31KF1
Appr			Replacement of		Scale 1:1		Document type:		MFS
Original			Replaced by				Project nr:		22-16152
Modification	Date	Name	Original				Page		1
									275





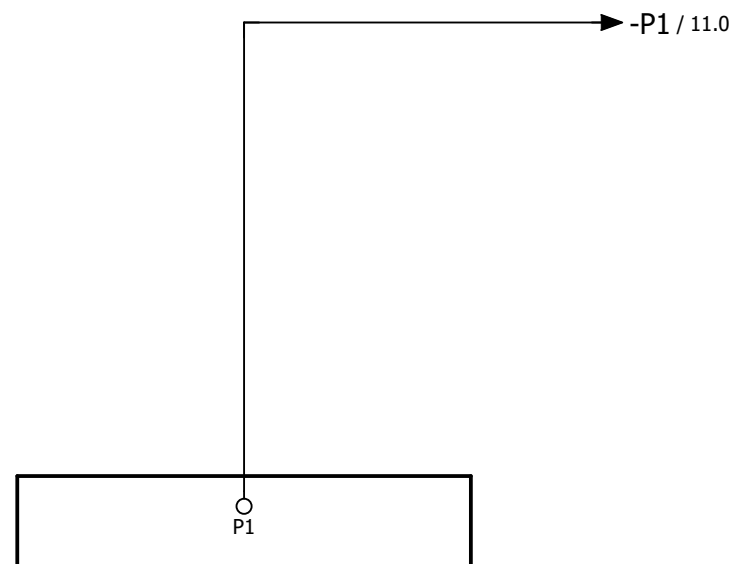

=V1AR31XQ41UQ2+.AR31KF1/1

		Date	1/3/2023	Volvo Trucks North America		Valiant TMS	AIR SUPPLY GRIPPER	Drawing name:		= V1AR41UQ41KF1
		Ed.	MKLEPADLO	P6700 Framing - Cell 2V01, KF1				=2V01&MFS-PNEU_KF1		+ V1AR41UQ41
Modification	Date	Name	Original	Replacement of	Replaced by	Scale 1:1		Document type:	Project nr:	Page
								MFS	22-16152	1
										275





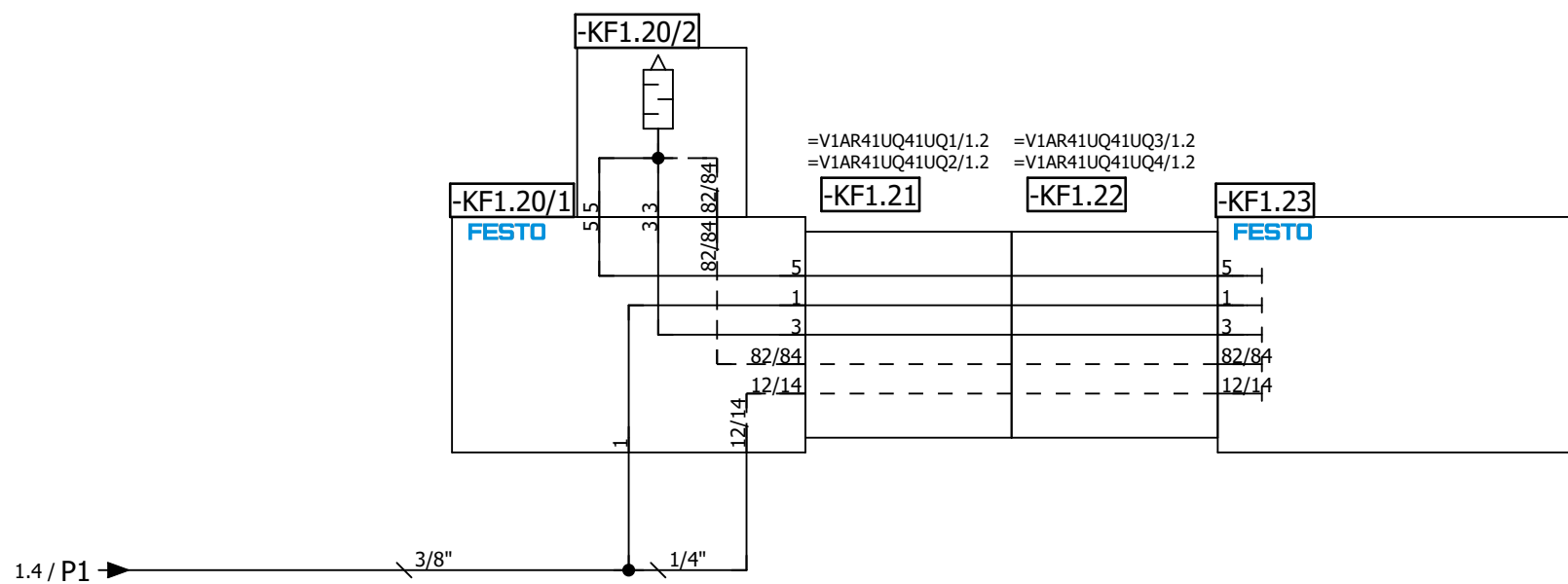
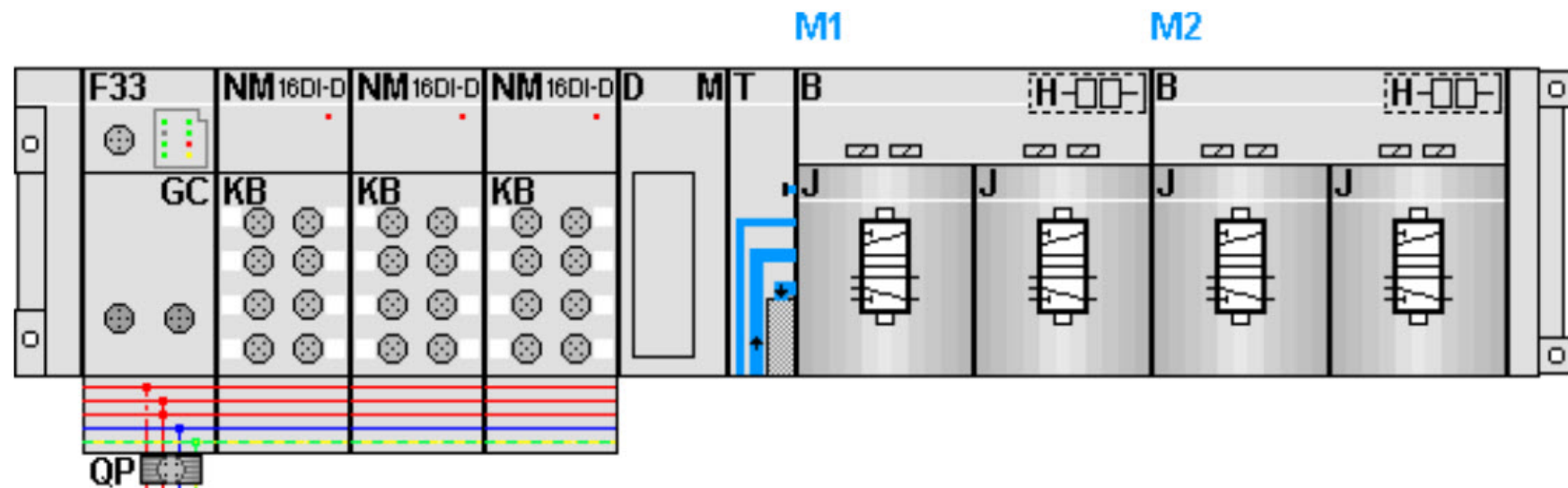

Date		1/17/2023	Volvo Trucks North America		Valiant TMS	AIR SUPPLY	Drawing name:		= V1AR41UQ41KF1			
Ed.		MKLEPADLO	P6700 Framing - Cell 2V01, KF1				=2V01&MFS-PNEU_KF1		+ V1AR41UQ41			
Appr.			Replacement of		Scale 1:1	Document type:		MFS	Project nr:	22-16152	Page	11
Original			Replaced by			MFS		22-16152		275		

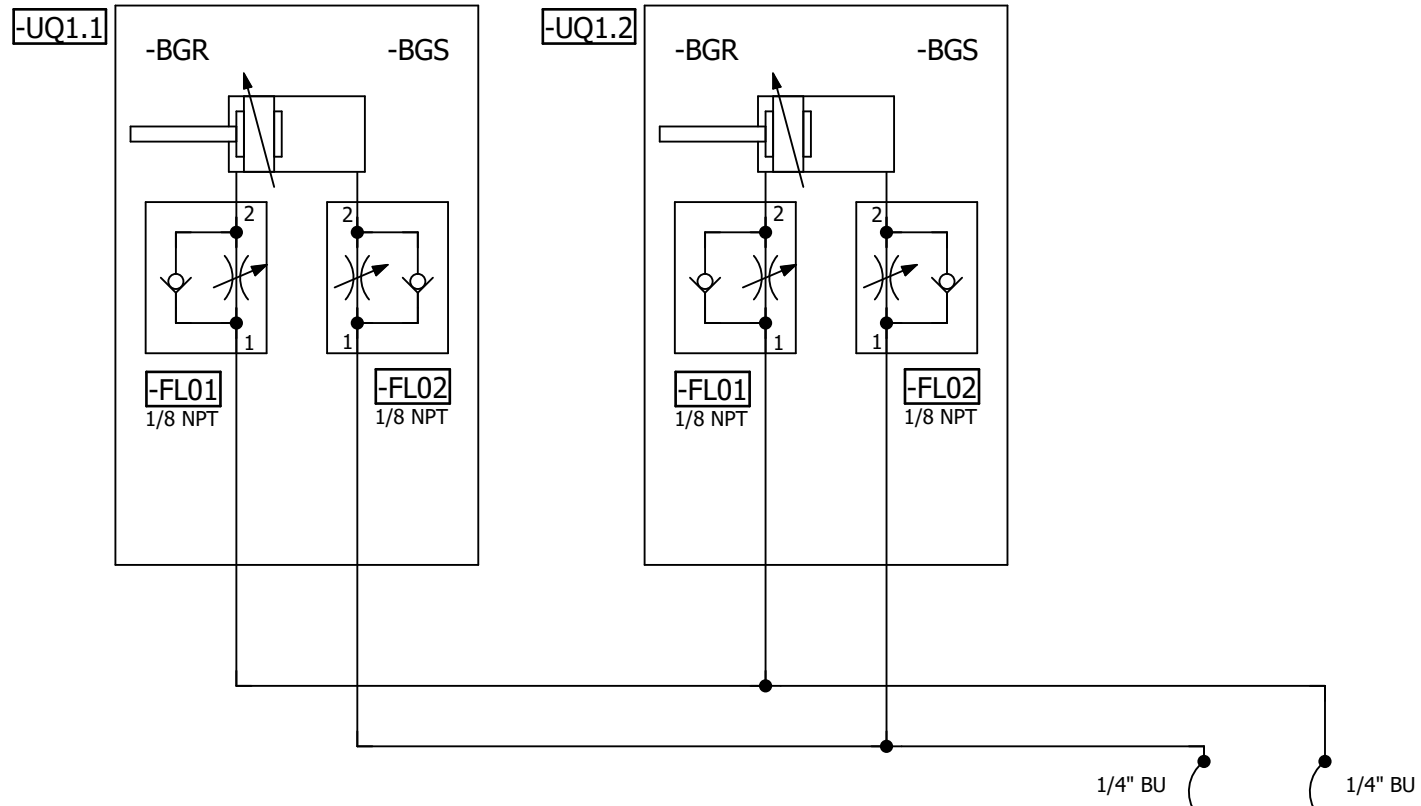

=V1AR41UQ41KF1

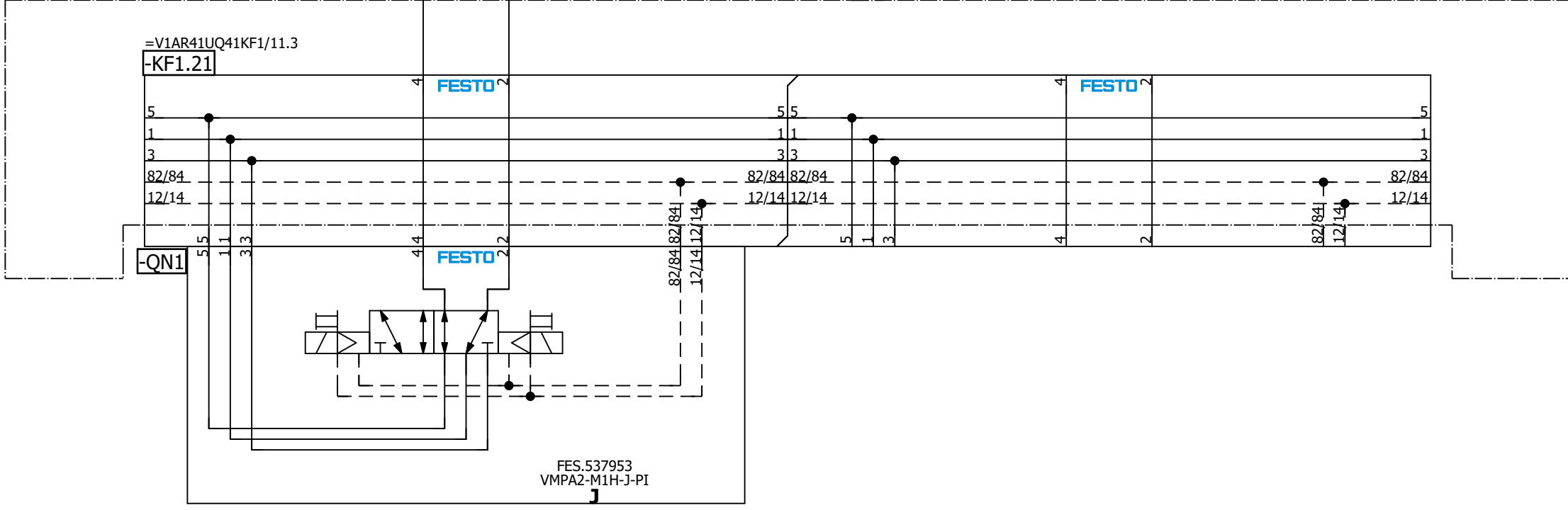

=V1AR41UQ41  
-UQ1-QN1.1  
Common  
Shot Pins (RST)

=V1AR41UQ41  
-UQ1-QN1.2  
Common  
Shot Pins (SET)

=V1AR41UQ41KF1/11

=V1AR41UQ41UQ2/1

		Date	1/17/2023	Volvo Trucks North America		Valiant TMS		Common Shot Pins		Drawing name: =2V01&MFS-PNEU_KF1		= V1AR41UQ41UQ1	
		Ed.	MKLEPADLO	P6700 Framing - Cell 2V01, KF1		Scale 1:1				Document type: MFS		Project nr: 22-16152	
		Appr		Replacement of						Replaced by			
Modification	Date	Name	Original									275	

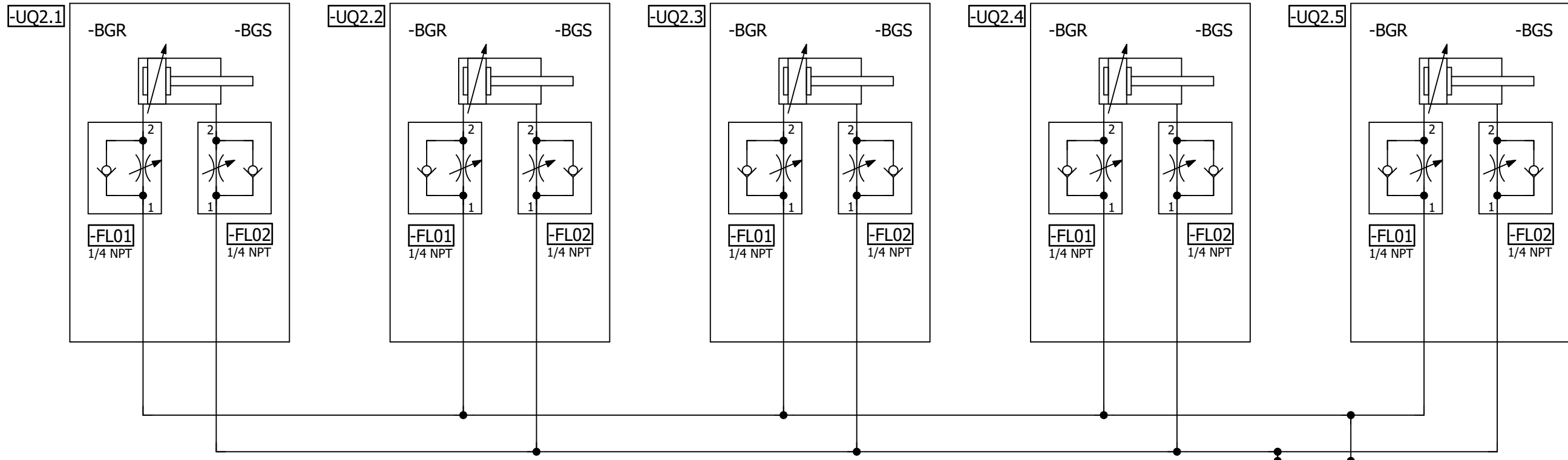

=V1AR41UQ41KF1

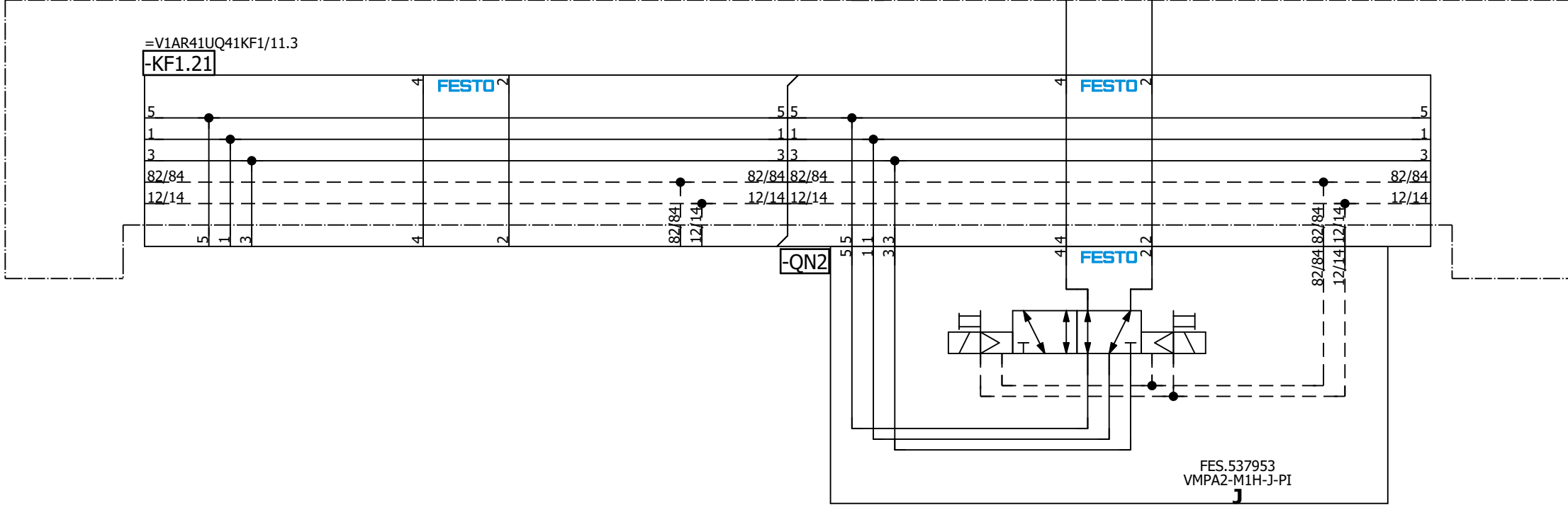

=V1AR41UQ41  
-UQ2-QN2.1  
Common  
Clamps 1 (RST)

=V1AR41UQ41  
-UQ2-QN2.2  
Common  
Clamps 1 (SET)

=V1AR41UQ41UQ1/1

=V1AR41UQ41UQ3/1

Date: 1/17/2023		Volvo Trucks North America		Valiant TMS		Common Clamps 1		Drawing name: =2V01&MFS-PNEU_KF1		= V1AR41UQ41UQ2	
Ed.: MKLEPADLO		P6700 Framing - Cell 2V01, KF1		Scale 1:1				Document type: MFS		+ V1AR41UQ41	
Appr:		Replacement of		Replaced by				Project nr: 22-16152		Page 1	
Original										275	





A2

=KH0+KH0/1.8 / +V1GL13KH1-P1 →

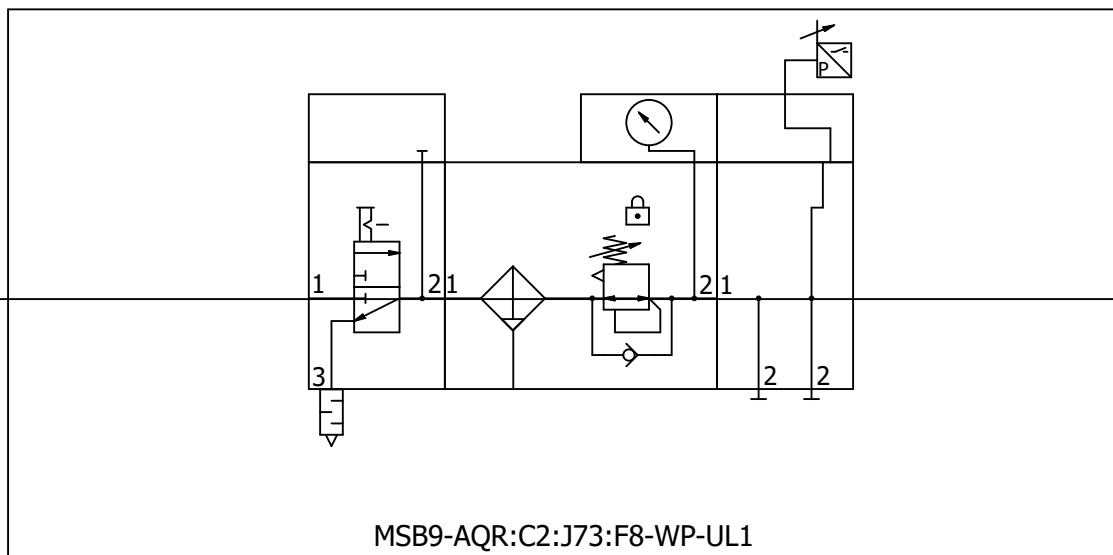

→ +V1GL13UQ51-P1 / =V1GL13UQ51KF2+V1GL13UQ51/11.0

MSB9-AQR:C2:J73:F8-WP-UL1

=V1AR41UQ41UQ4+V1AR41UQ41/1

=V1GL13UQ51KF2+V1GL13UQ51/5

		Date	12/15/2022	Volvo Trucks North America			Valiant TMS	Incoming air supply (Conveyor)	Drawing name:		= V1GL13
		Ed.	MKLEPADLO	P6700 Framing - Cell 2V01, KF1					=2V01&MFS-PNEU_KF1		+ KH1
		Appr		Replacement of			Scale 1:1	Document type:		Project nr:	Page
Modification	Date	Name	Original	Replaced by				MFS		22-16152	1
											275



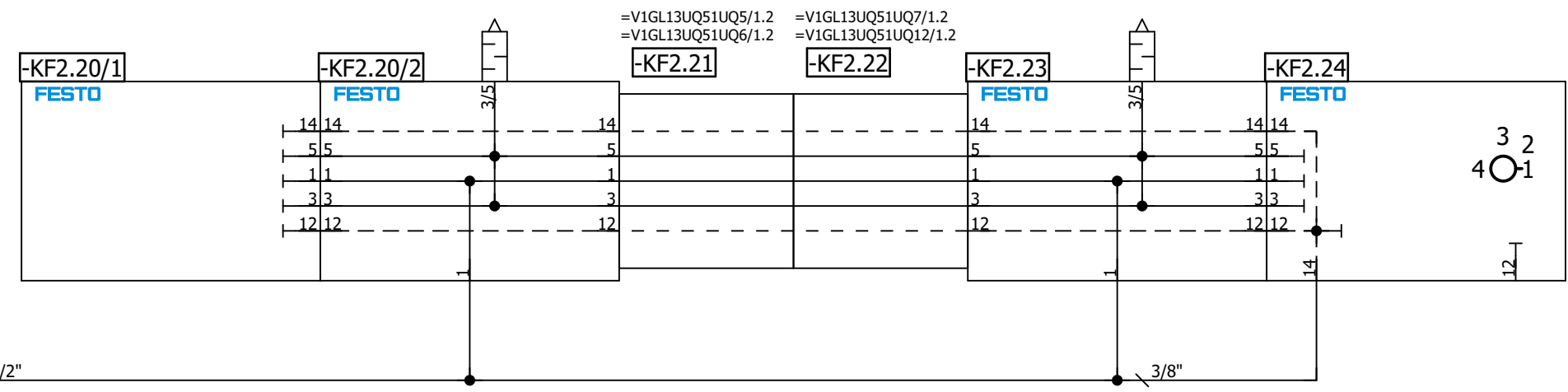
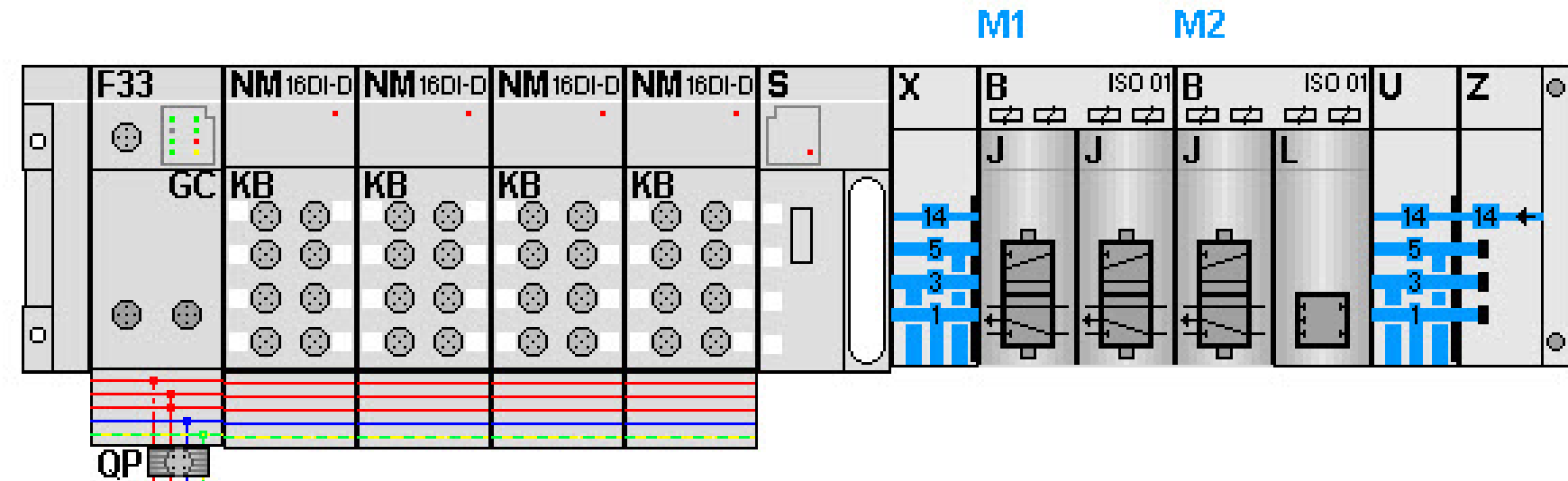

=V1GL13+KH1/1.6 / P1

Date		1/17/2023	Volvo Trucks North America		Valiant TMS	AIR SUPPLY	Drawing name:		= V1GL13UQ51KF2			
Ed.		MKLEPADLO	P6700 Framing - Cell 2V01, KF1				=2V01&MFS-PNEU_KF1		+ V1GL13UQ51			
Appr			Replacement of		Scale 1:1	Document type:		MFS	Project nr:	22-16152	Page	11
Original			Replaced by			MFS					275	









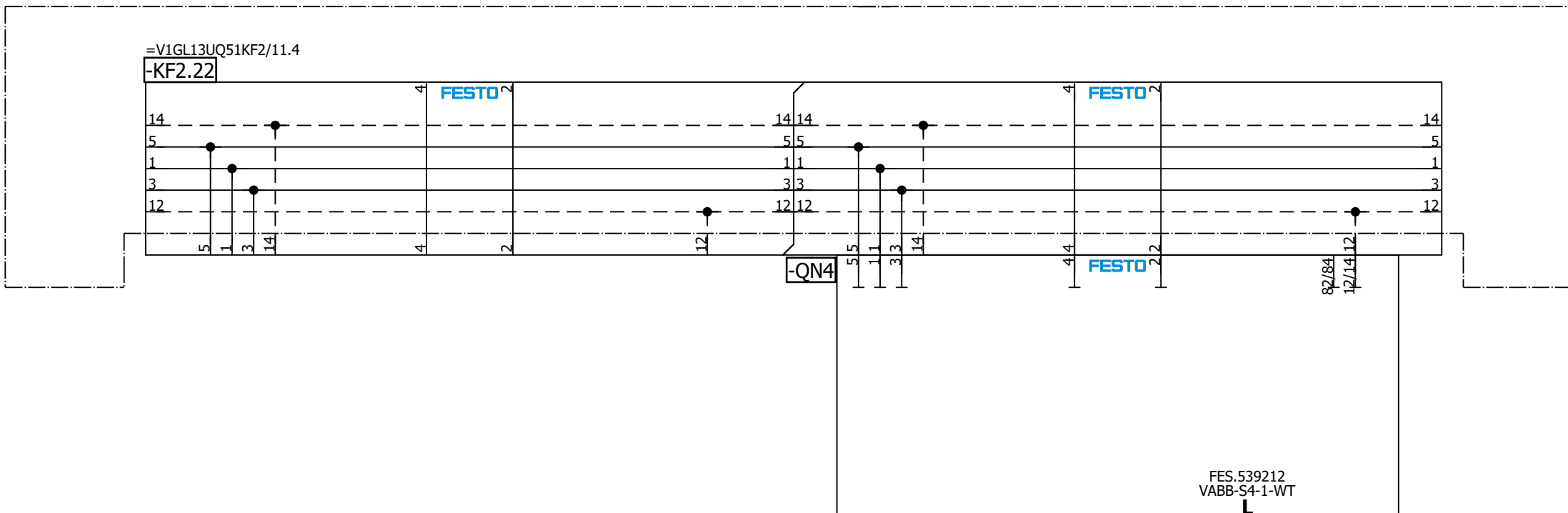

=V1GL13UQ51KF2



=V1GL13UQ51UQ7/1

=V1GL14+KH1/1

		Date	1/16/2023	Volvo Trucks North America			Valiant TMS	Spare	Drawing name:		= V1GL13UQ51UQ12	
		Ed.	MKLEPADLO	P6700 Framing - Cell 2V01, KF1					=2V01&MFS-PNEU_KF1		+ V1GL13UQ51	
Modification	Date	Name	Original	Replacement of	Replaced by		Scale 1:1		Document type:	Project nr:	Page	1
									MFS	22-16152		275

A2

=KH0+KH0/1.8 / +V1GL14KH1-P1 →

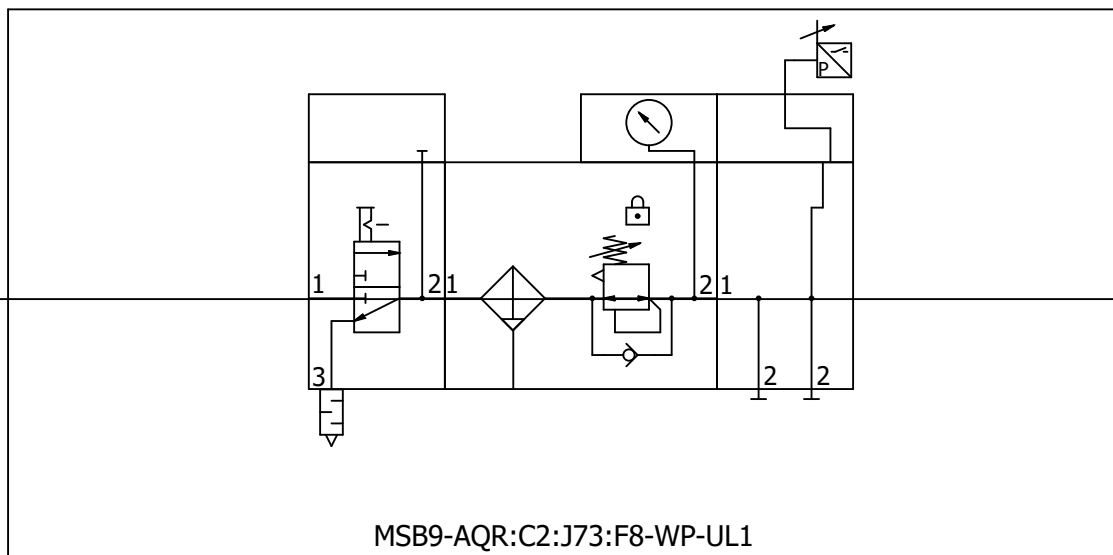

→ +V1GL14UQ51-P1 / =V1GL14UQ51KF2+V1GL14UQ51/11.0

MSB9-AQR:C2:J73:F8-WP-UL1

=V1GL13UQ51UQ12+V1GL13UQ51/1

=V1GL14UQ51KF2+V1GL14UQ51/5

		Date	12/20/2022	Volvo Trucks North America			Valiant TMS	Incoming air supply (Conveyor)	Drawing name:		= V1GL14
		Ed.	MKLEPADLO	P6700 Framing - Cell 2V01, KF1					=2V01&MFS-PNEU_KF1		+ KH1
		Appr		Replacement of			Scale 1:1	Document type:		Project nr:	Page
Modification	Date	Name	Original	Replaced by				MFS		22-16152	1
											275

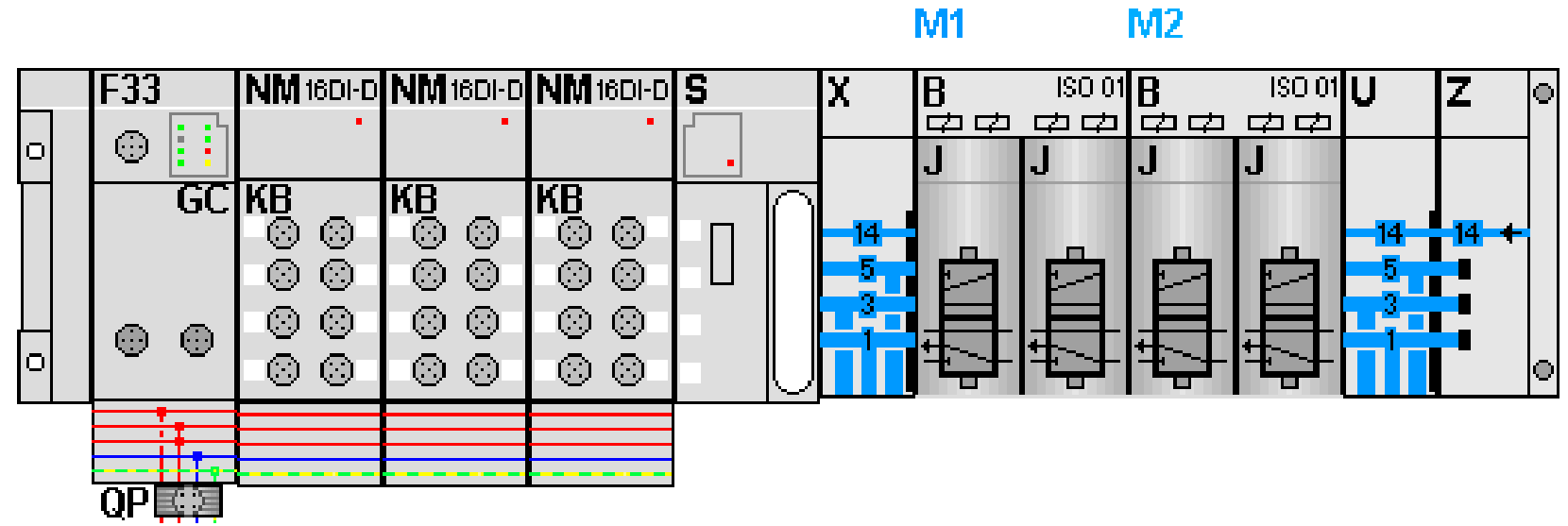

KF2.0

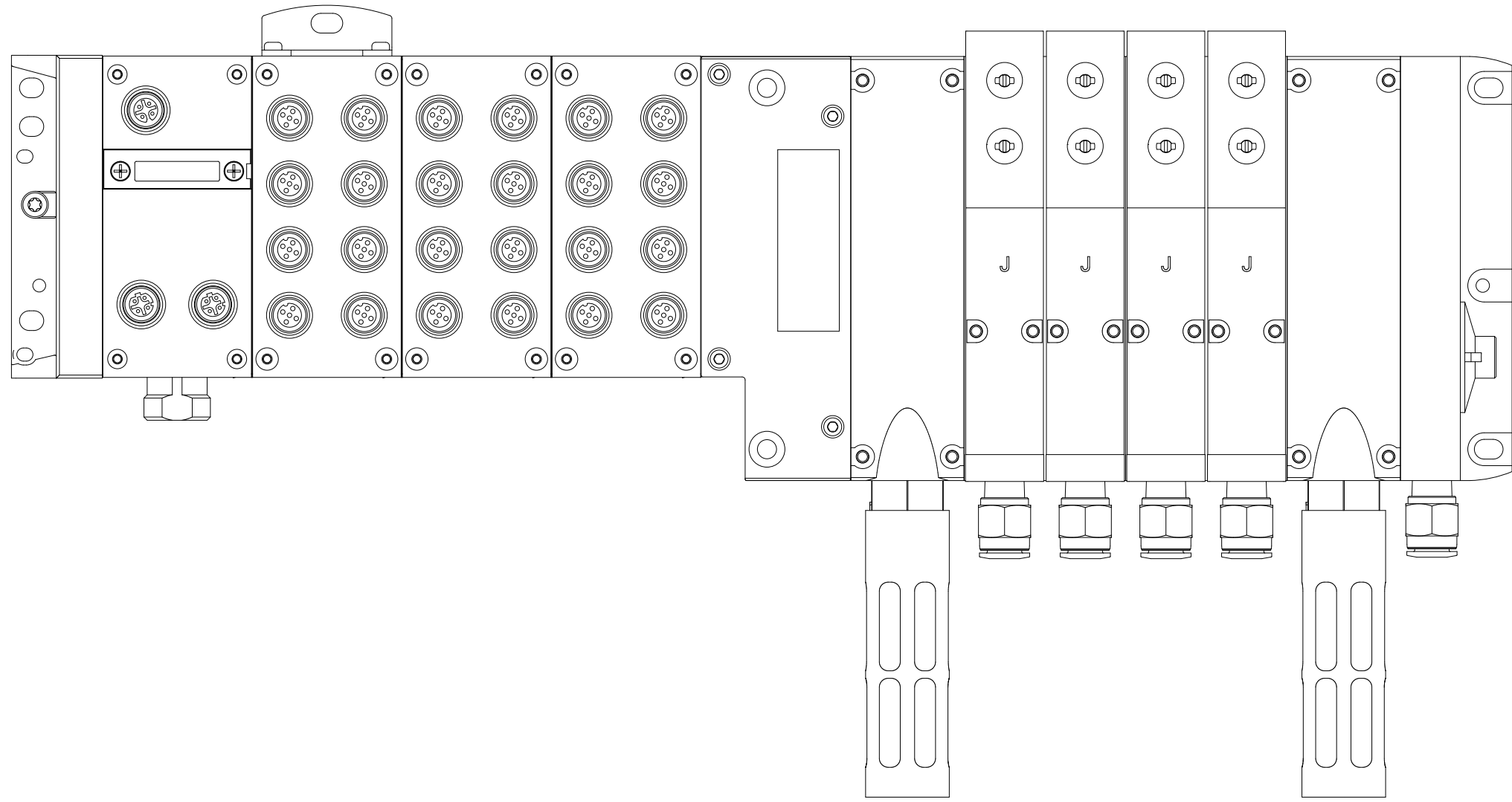

=V1GL14+KH1/1

Date		1/17/2023		Volvo Trucks North America		Valiant TMS		AIR SUPPLY CONFIGURATION		Drawing name:		= V1GL14UQ51KF2			
Ed.		MKLEPADLO		P6700 Framing - Cell 2V01, KF1		Scale 1:1				Document type:		= 2V01&MFS-PNEU_KF1			
Appr				Replacement of		Replaced by				Project nr:		22-16152			
Modification	Date	Name	Original							MFS		Page 5			
												+ V1GL14UQ51		275	

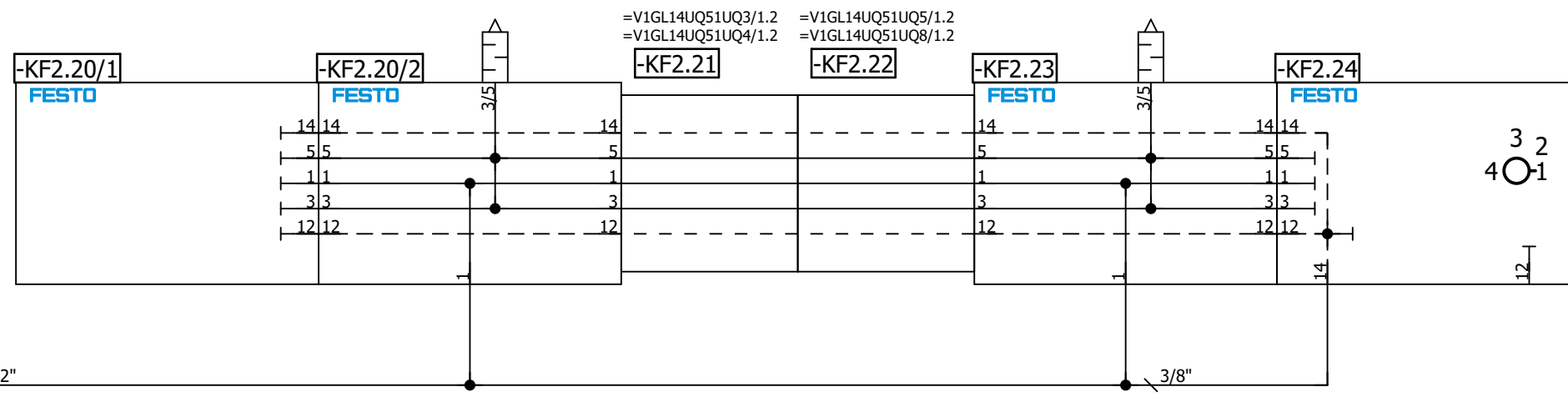
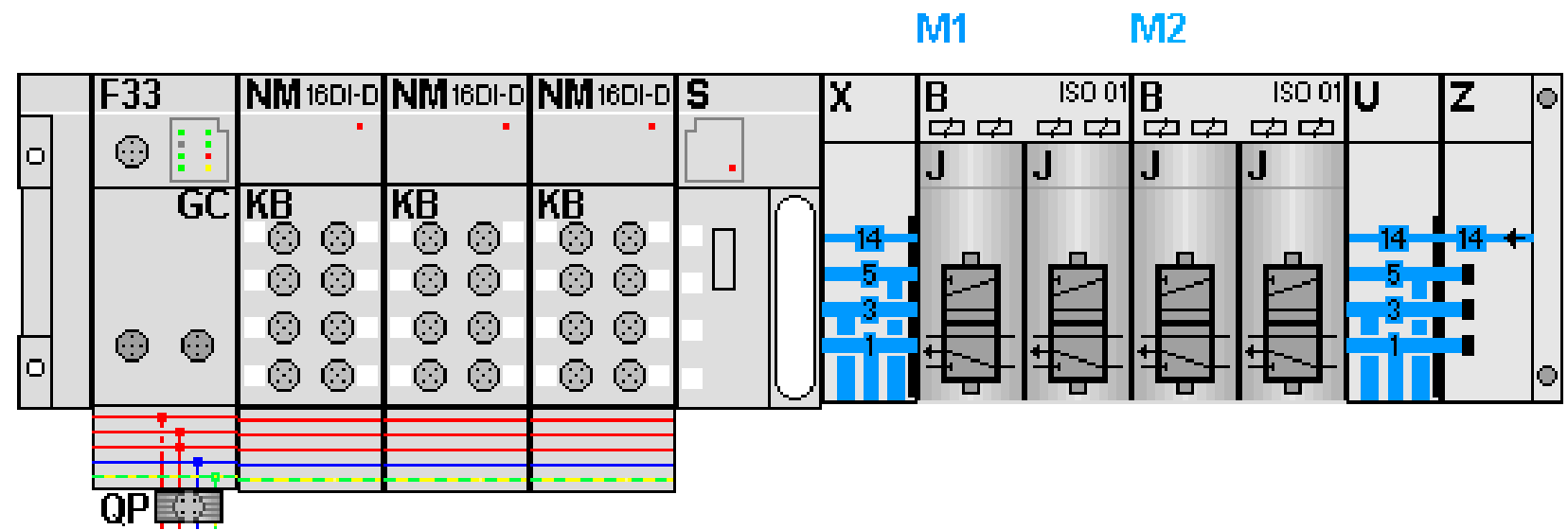





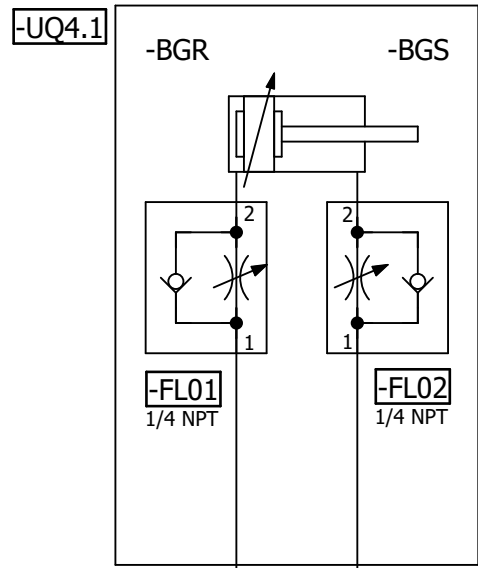

=V1GL14UQ51KF2

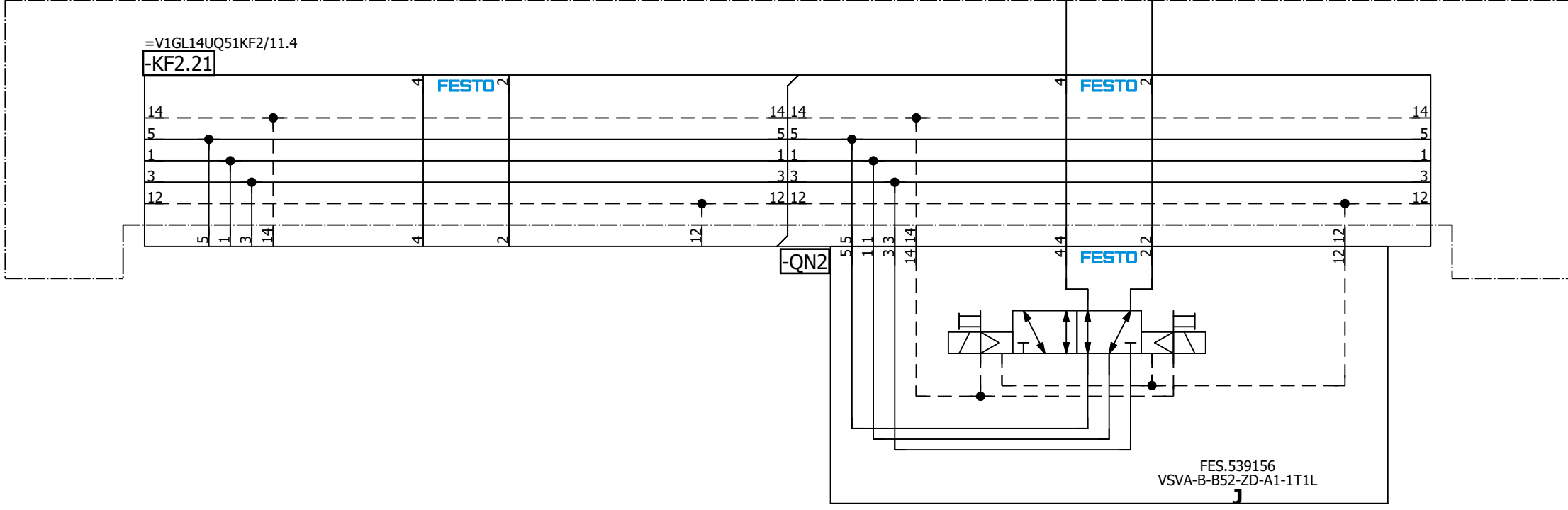

=V1GL14UQ51  
-UQ4-QN2.1  
Pallet Stop Sta #4  
Unload (RST)

=V1GL14UQ51  
-UQ4-QN2.2  
Pallet Stop Sta #4  
Unload (SET)

=V1GL14UQ51UQ3/1

=V1GL14UQ51UQ5/1

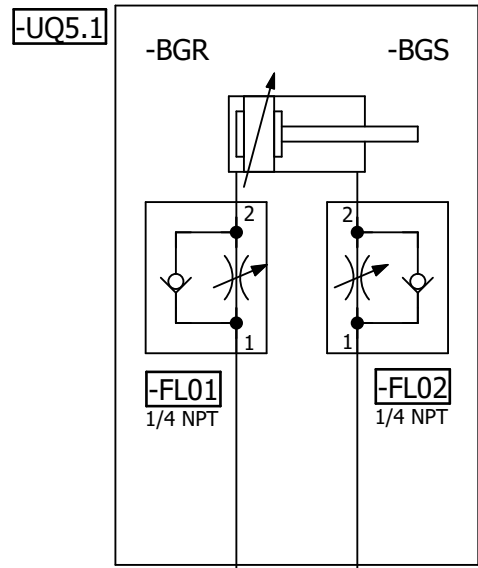

=V1GL14UQ51KF2

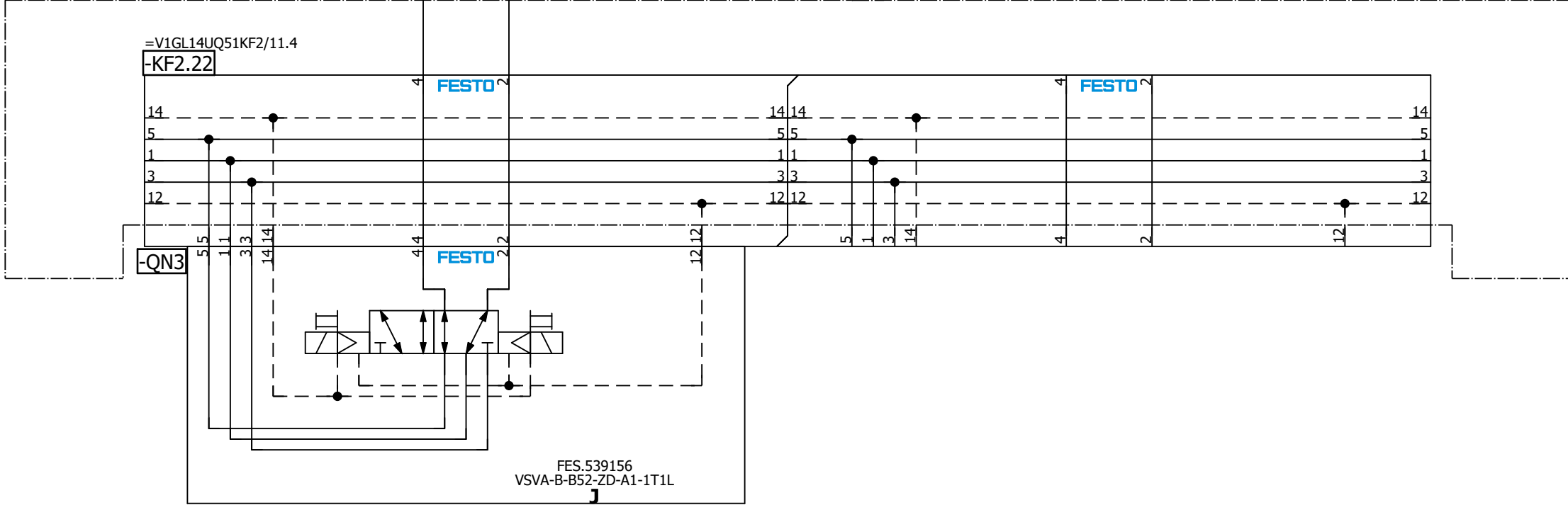

=V1GL14UQ51  
-UQ5-QN3.1  
Pallet Stop Sta #5  
Mid-Stop#2 (RST)

=V1GL14UQ51  
-UQ5-QN3.2  
Pallet Stop Sta #5  
Mid-Stop#2 (SET)

=V1GL14UQ51UQ4/1			=V1GL14UQ51UQ8/1		
Modification	Date	Name	Date	1/17/2023	Volvo Trucks North America
			Ed.	MKLEPADLO	Valiant TMS
			Appr		Pallet Stop Station #5 Mid-Stop #2
			Original		Drawing name: =2V01&MFS-PNEU_KF1 Document type: MFS Project nr: 22-16152
			Replacement of		= V1GL14UQ51UQ5 + V1GL14UQ51 Page 1 275
			Replaced by		Scale 1:1



A2

=KH0+KH0/1.8 / +V1GM1KH1-P1

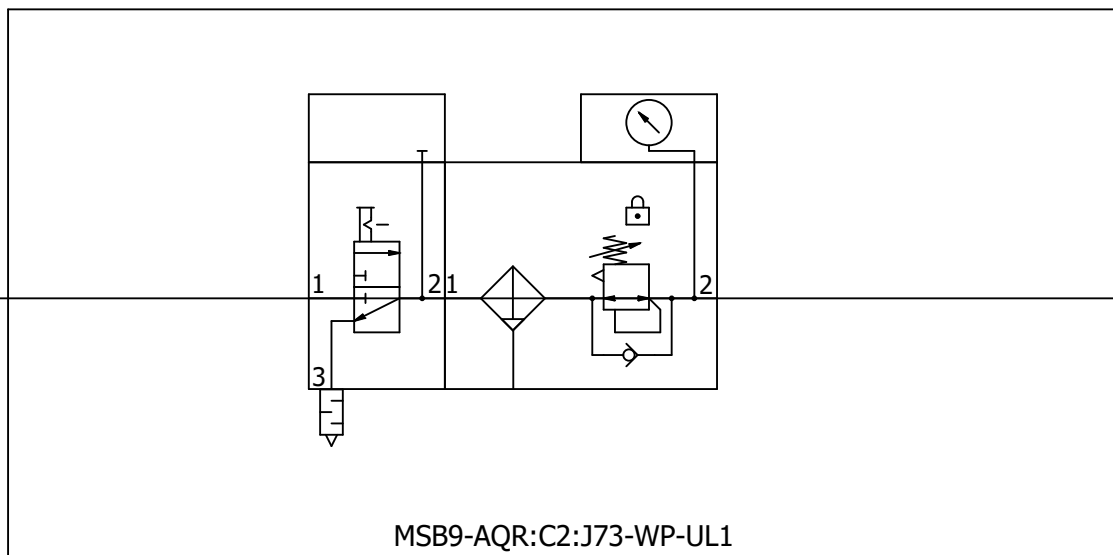

MSB9-AQR:C2:J73-WP-UL1

1/2"

+V1GM1KH1-P1 / S020 Lift Assist

=V1GL14UQ51UQ8+V1GL14UQ51/1

=V1UL1UQ1+V1UL1/1

		Date	12/20/2022	Volvo Trucks North America	Valiant TMS	Incoming air supply (Lift Assist)	Drawing name:		= V1GM1
		Ed.	MKLEPADLO				=2V01&MFS-PNEU_KF1		+ KH1
		Appr.		P6700 Framing - Cell 2V01, KF1	Scale 1:1		Document type:	Project nr:	Page
Modification	Date	Name	Original	Replacement of			Replaced by	MFS	22-16152
									275



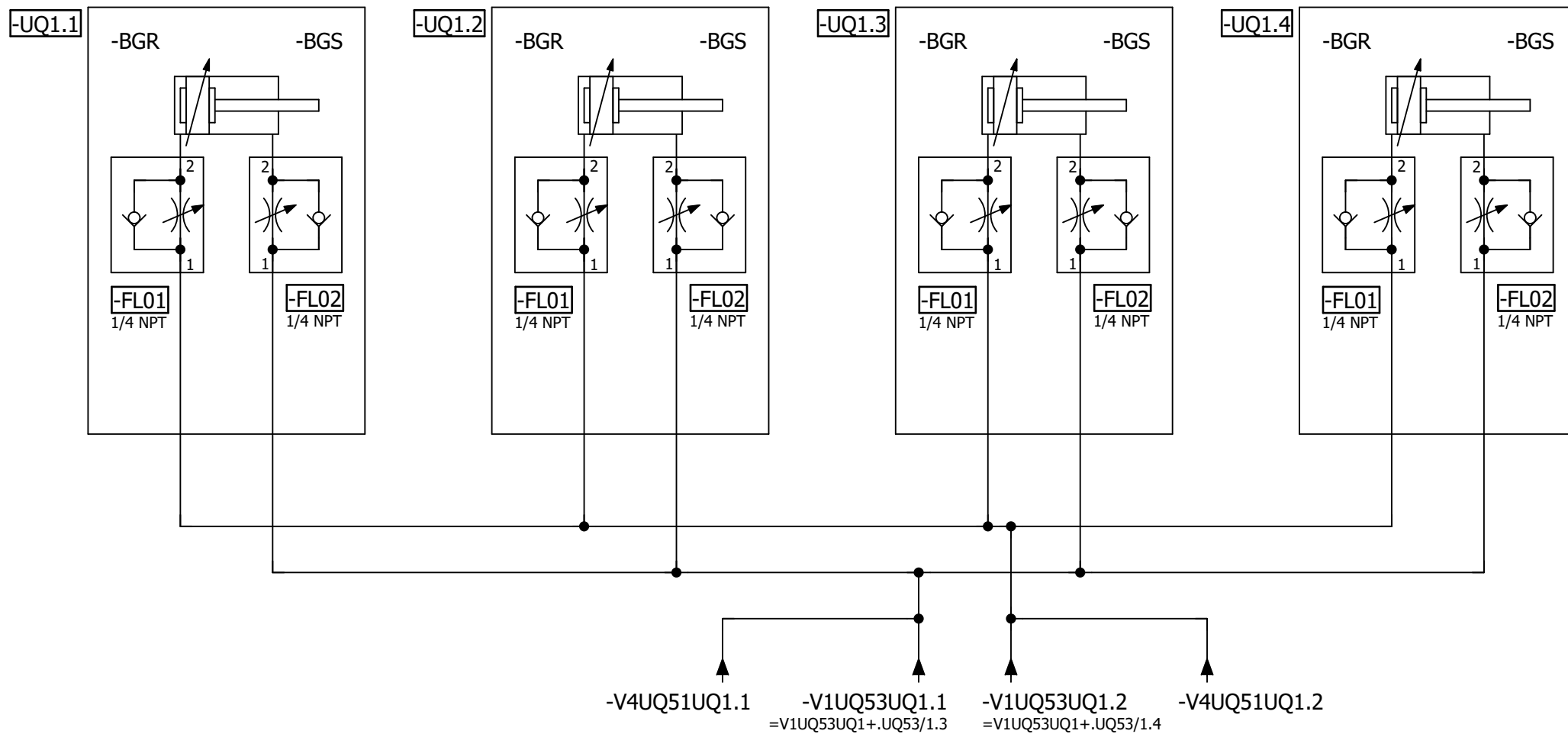

cross reference to Staubli interlock plate

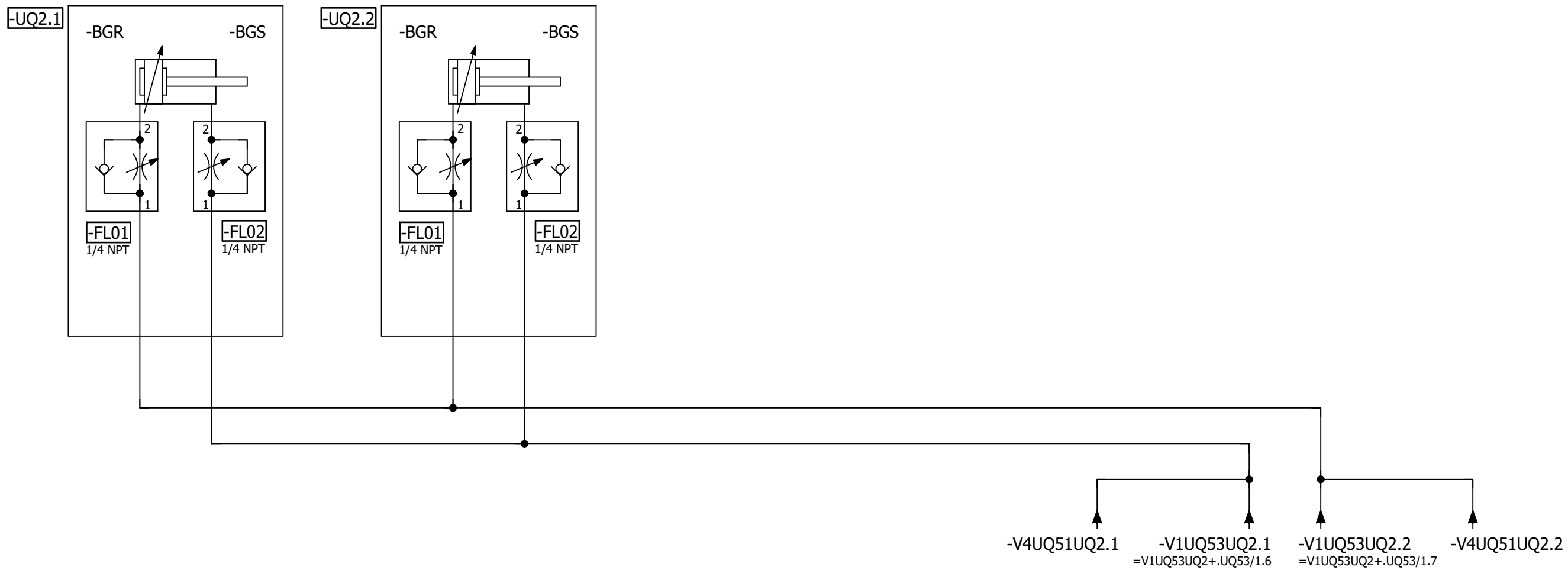

cross reference to Staubli interlock plate

=V1UL1UQ1/1

=V1UL1UQ3/1

Date		1/17/2023		Volvo Trucks North America		Valiant TMS		Common Pin Clamp 2		Drawing name:		= V1UL1UQ2	
Ed.		MKLEPADLO		P6700 Framing - Cell 2V01, KF1		Scale 1:1				Document type:		= 2V01&MFS-PNEU_KF1	
Appr				Replacement of		Replaced by				Project nr:		Page	
Modification		Date		Name		Original				MFS		22-16152	
												1	
												275	







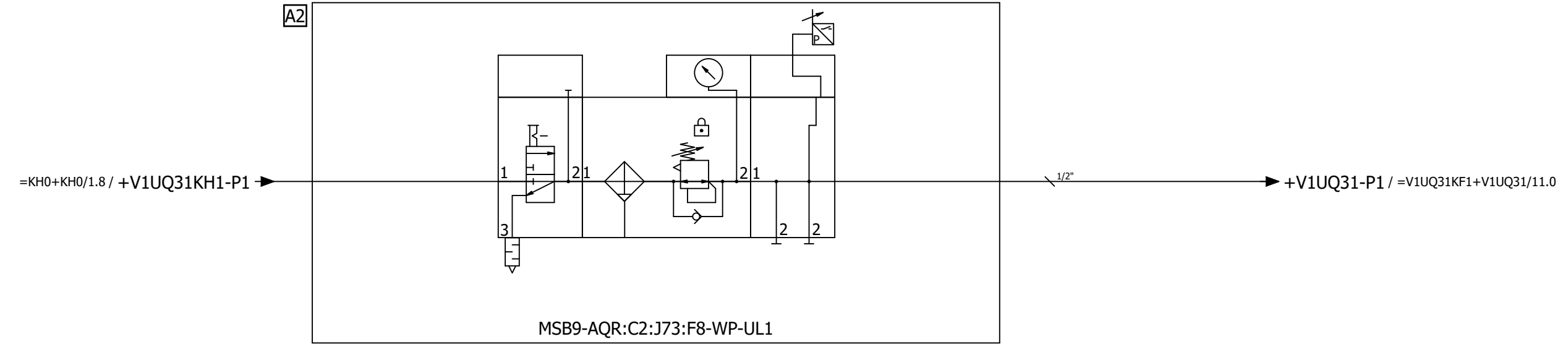

=V1UL1UQ4+V1UL1/1

=V1UQ31KF1+V1UQ31/5

			Date	12/20/2022	Volvo Trucks North America		Valiant TMS	Incoming air supply (Fixture)	Drawing name:	= V1UQ31	
			Ed.	MKLEPADLO	P6700 Framing - Cell 2V01, KF1					=2V01&MFS-PNEU_KF1	+ KH1
Modification	Date	Name	Appr	Original	Replacement of	Replaced by	Scale 1:1		Document type:	Project nr:	Page
									MFS	22-16152	1
											275

M1

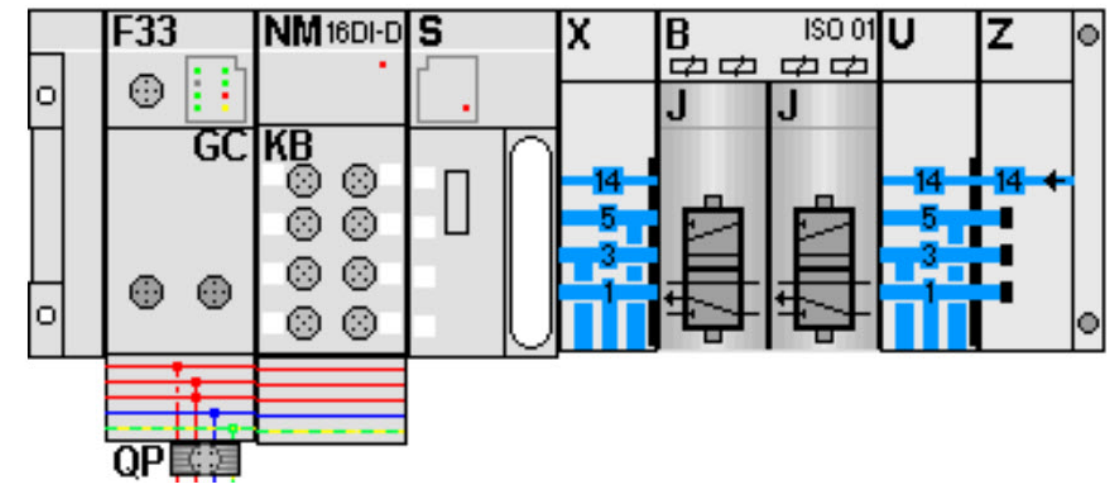

KF1.0

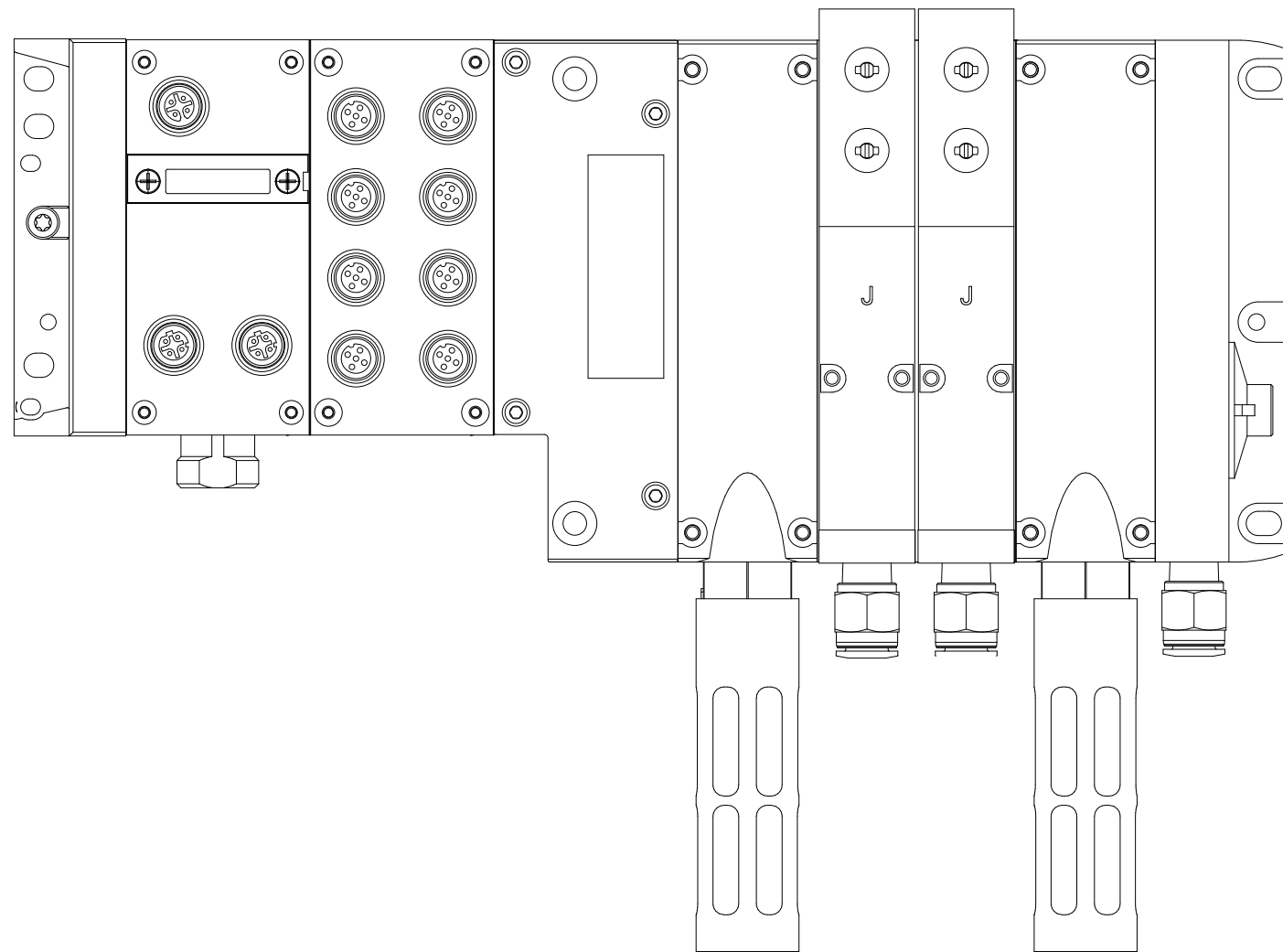

=V1UQ31+KH1/1

		Date	1/17/2023	Volvo Trucks North America		Valiant TMS		AIR SUPPLY CONFIGURATION		Drawing name: =2V01&MFS-PNEU_KF1		= V1UQ31KF1	
		Ed.	MKLEPADLO	P6700 Framing - Cell 2V01, KF1						Document type: MFS		Project nr: 22-16152	
Modification	Date	Name	Original	Replacement of	Replaced by	Scale 1:1						Page	5
													275



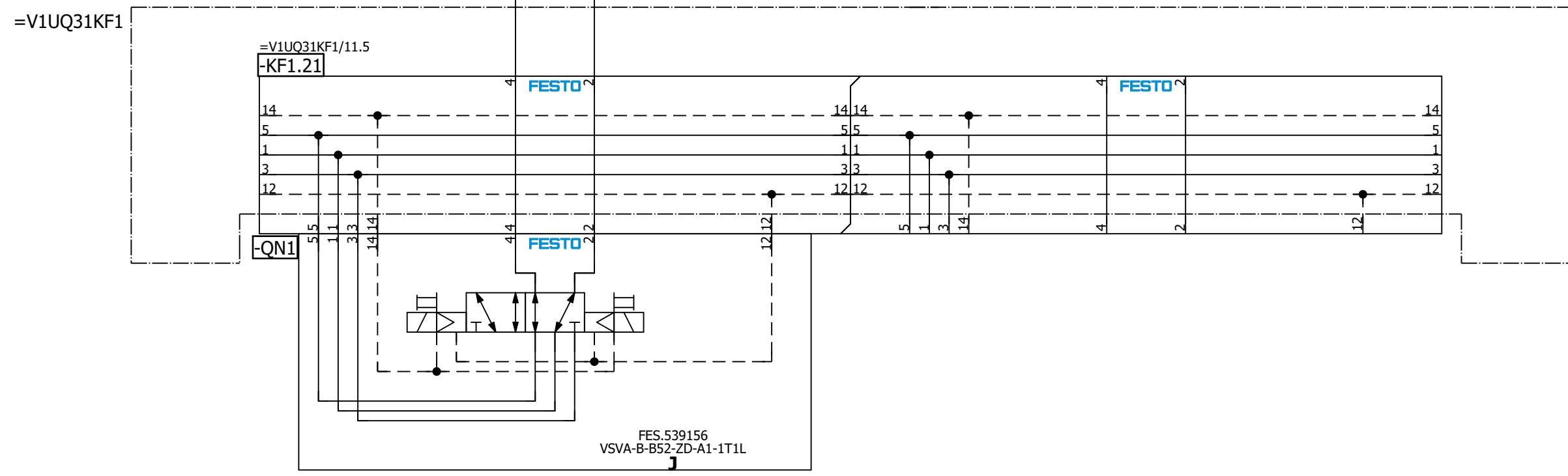
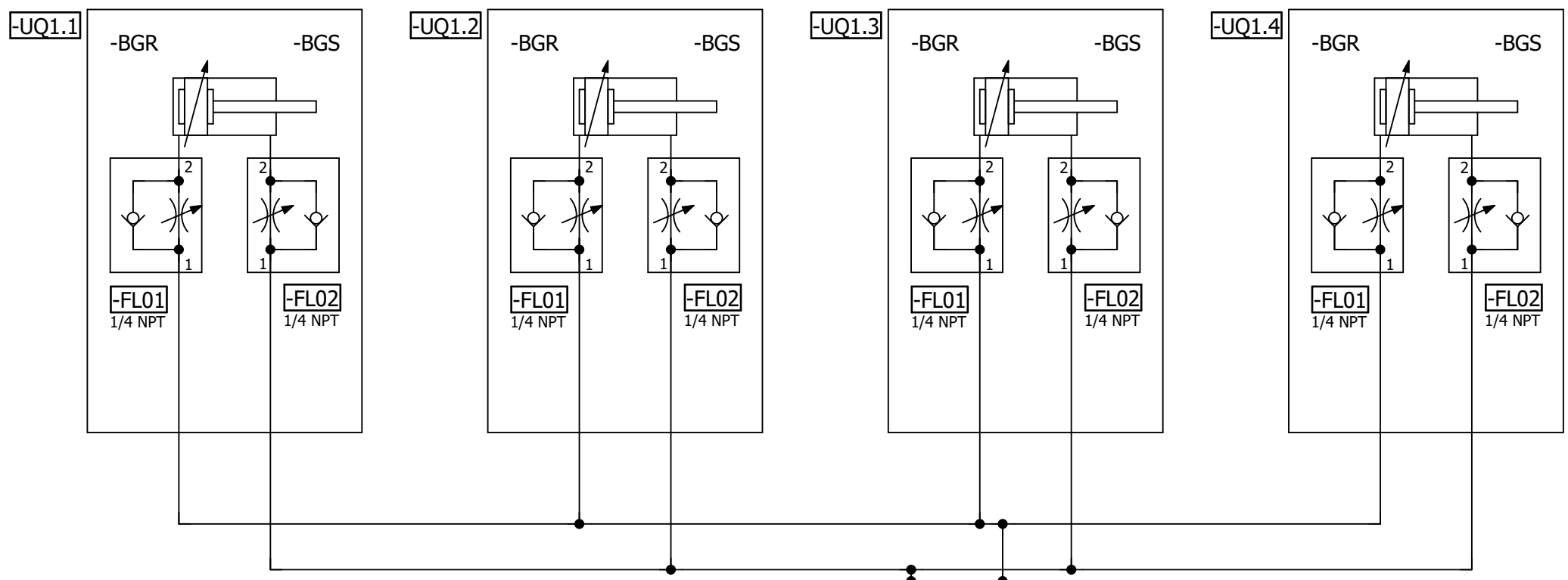

=V1UQ31  
-UQ1-QN1.1  
MH1 EOAT  
Clamps (RST)

=V1UQ31  
-UQ1-QN1.2  
MH1 EOAT  
Clamps (SET)

=V1UQ31KF1/11

=V1UQ31UQ2/1

Date: 12/20/2022		Volvo Trucks North America		Valiant TMS		Drawing name: =2V01&MFS-PNEU_KF1		= V1UQ31UQ1	
Ed.: MKLEPADLO		P6700 Framing - Cell 2V01, KF1		MH1 Clamps		Document type: MFS		+ V1UQ31	
Appr:		Replacement of		Scale 1:1		Project nr: 22-16152		Page 1	
Original		Replaced by						275	

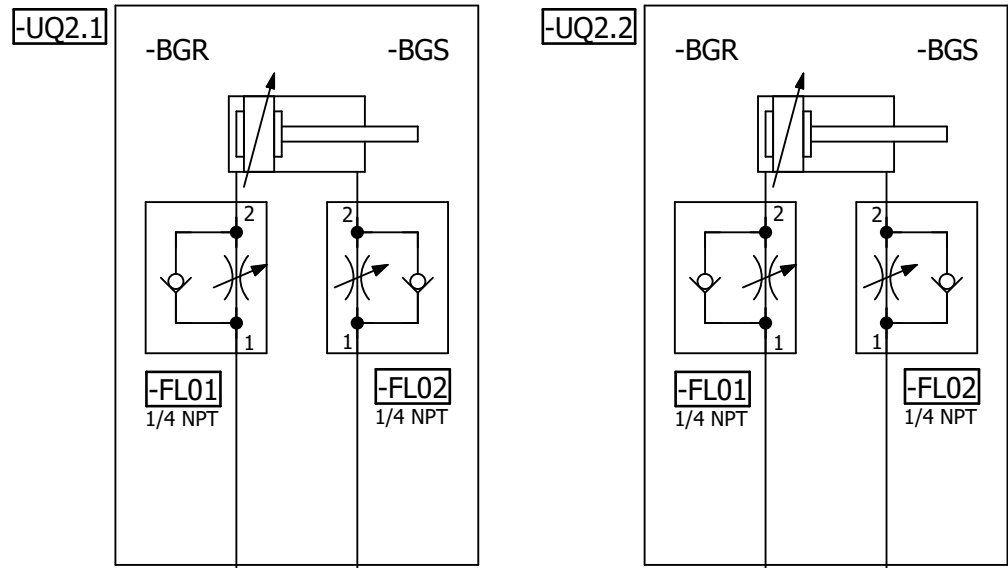

=V1UQ31KF1

=V1UQ31KF1/11.5  
-KF1.21

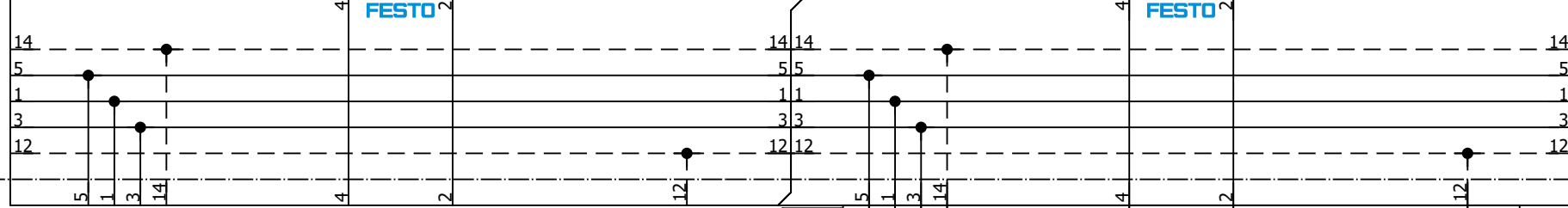

=V1UQ31  
-UQ2-QN2.1  
Common  
Clamps (RST)

=V1UQ31  
-UQ2-QN2.2  
Common  
Clamps (SET)

=V1UQ53+KH1/1

=V1UQ31UQ1/1			Date	12/20/2022	Volvo Trucks North America	Valiant TMS	Common Clamps	Drawing name:		= V1UQ31UQ2
			Ed.	MKLEPADLO				=2V01&MFS-PNEU_KF1		+ V1UQ31
Modification			Date		P6700 Framing - Cell 2V01, KF1	Scale 1:1		Document type:	Project nr:	Page
			Name	Original				Replacement of	Replaced by	MFS
										275

A2

=KH0+KH0/1.8 / +V1UQ53KH1-P1

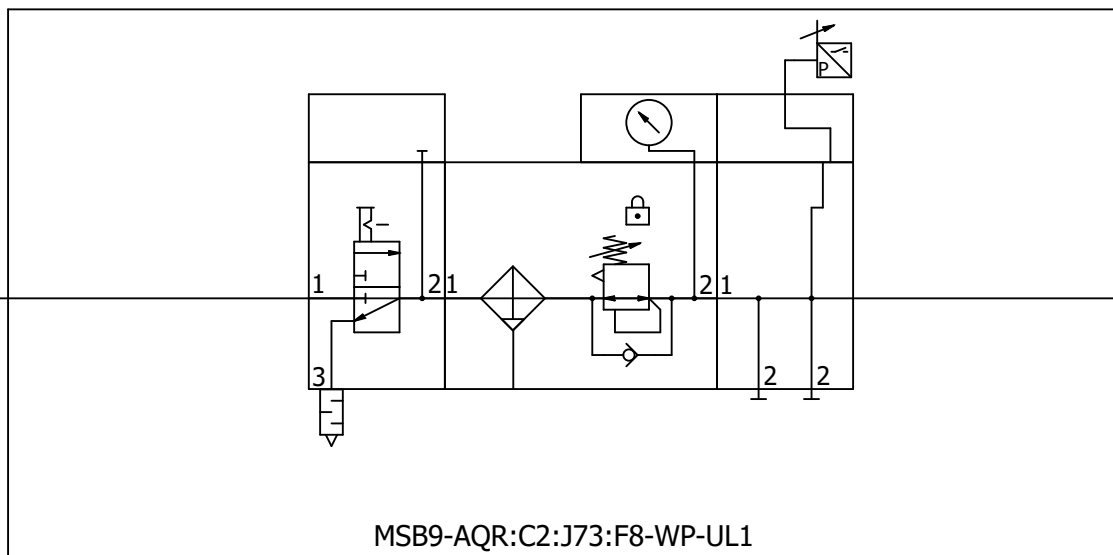

1/2"

+V1UQ53-P1 / =V1UQ53KF1+V1UQ53/11.0

=V1UQ31UQ2+V1UQ31/1

=V1UQ53KF1+V1UQ53/5

Date		12/20/2022	Volvo Trucks North America		Valiant TMS	Incoming air supply (Fixture)	Drawing name:		= V1UQ53			
Ed.		MKLEPADLO	P6700 Framing - Cell 2V01, KF1				=2V01&MFS-PNEU_KF1		+ KH1			
Appr.			Replacement of		Scale 1:1	Document type:		MFS	Project nr:	22-16152	Page	1
Modification	Date	Name	Original	Replaced by		MFS		22-16152		Page		1
										275		



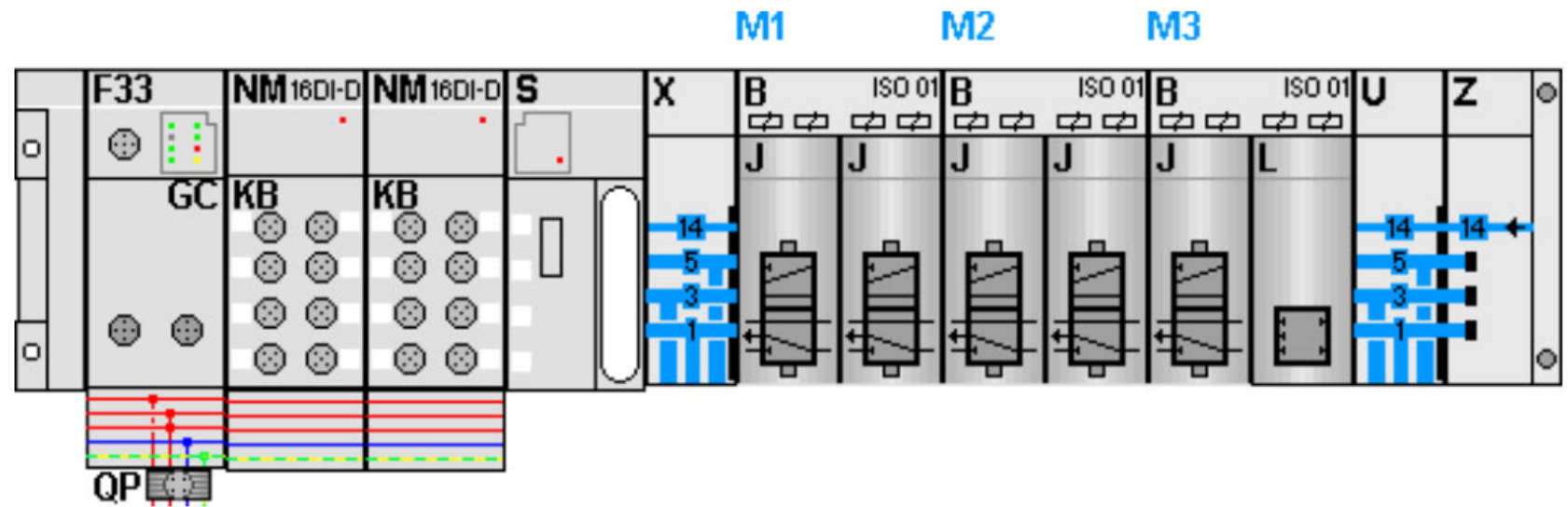

KF1.0

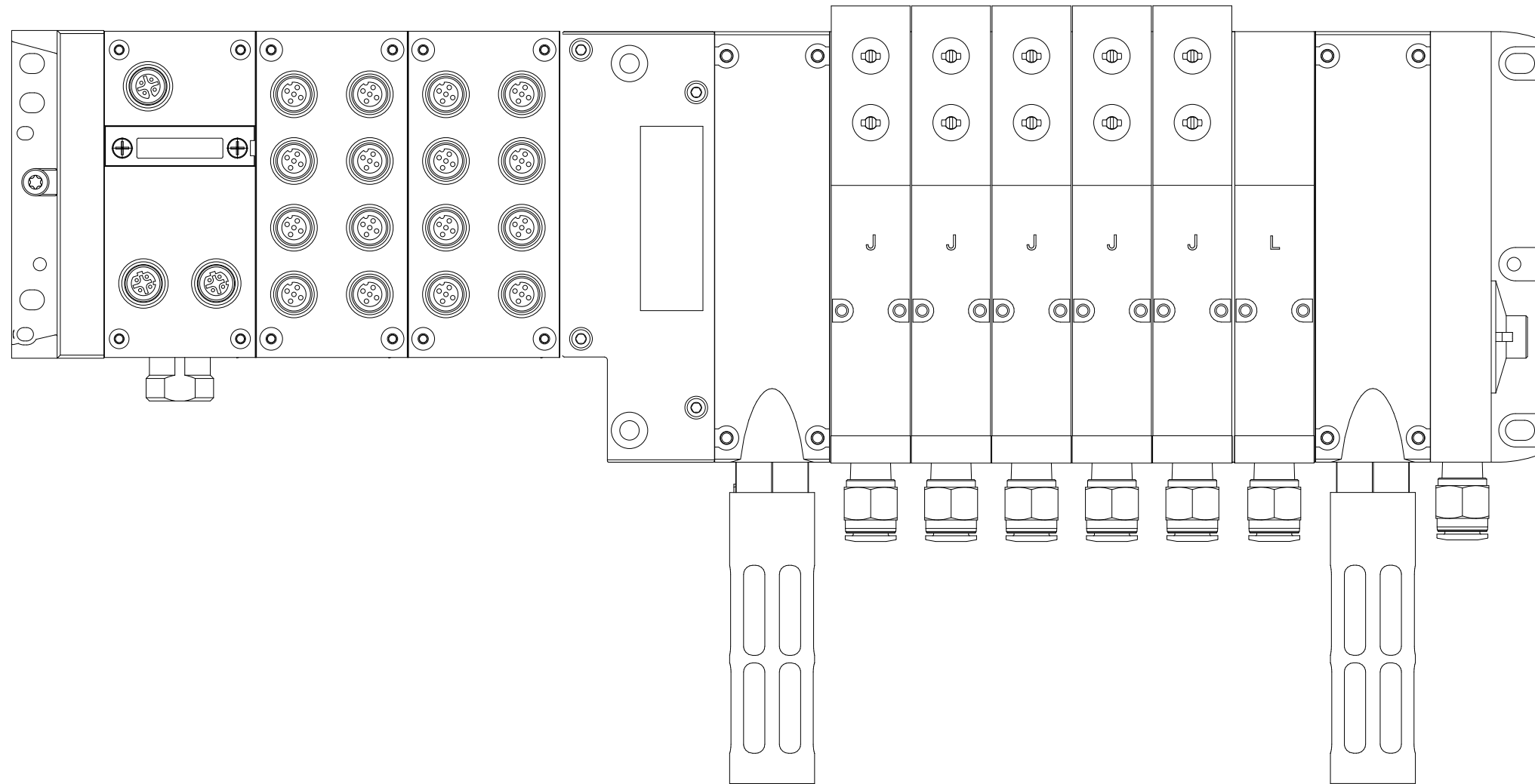

=V1UQ53+KH1/1

Date		1/17/2023	Volvo Trucks North America		Valiant TMS	AIR SUPPLY CONFIGURATION	Drawing name:		= V1UQ53KF1				
Ed.		MKLEPADLO	P6700 Framing - Cell 2V01, KF1				=2V01&MFS-PNEU_KF1		+ V1UQ53				
Appr			Replacement of		Scale 1:1	Document type:		MFS	Project nr:		22-16152	Page	5
Modification	Date	Name	Original	Replaced by		MFS		22-16152				Page	5
												275	





cross reference to Staubli interlock plate

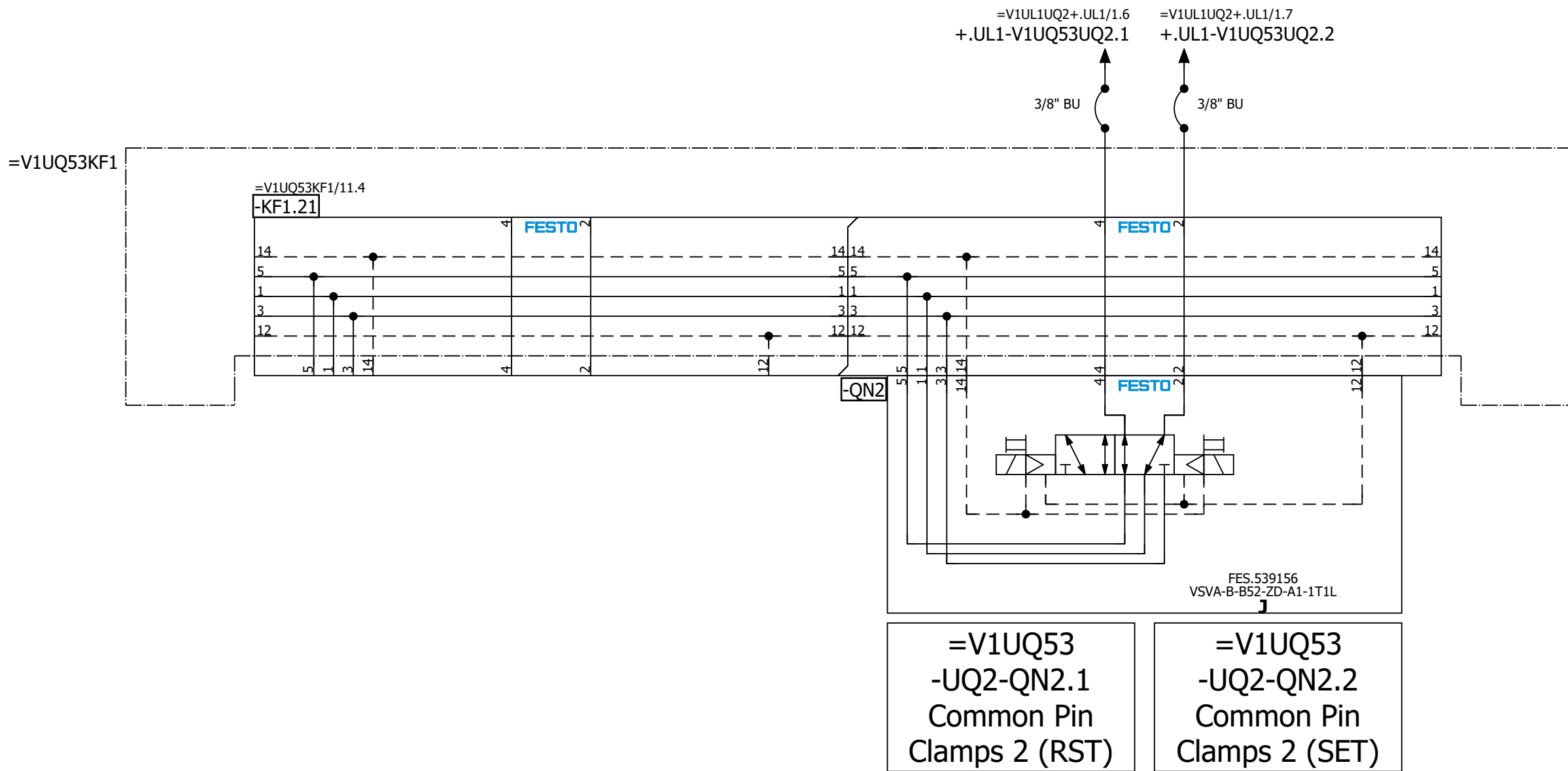

=V1UQ53UQ1/1 =V1UQ53UQ3/1

Date		1/17/2023		Volvo Trucks North America		Valiant TMS		Common Pin Clamp 2		Drawing name:		= V1UQ53UQ2	
Ed.		MKLEPADLO		P6700 Framing - Cell 2V01, KF1		Scale 1:1				Document type:		= V1UQ53UQ2	
Appr.				Replacement of		Replaced by				Project nr:		Page	
Original										22-16152		1	
Modification		Date		Name		Original				MFS		275	



cross reference to Staubli interlock plate

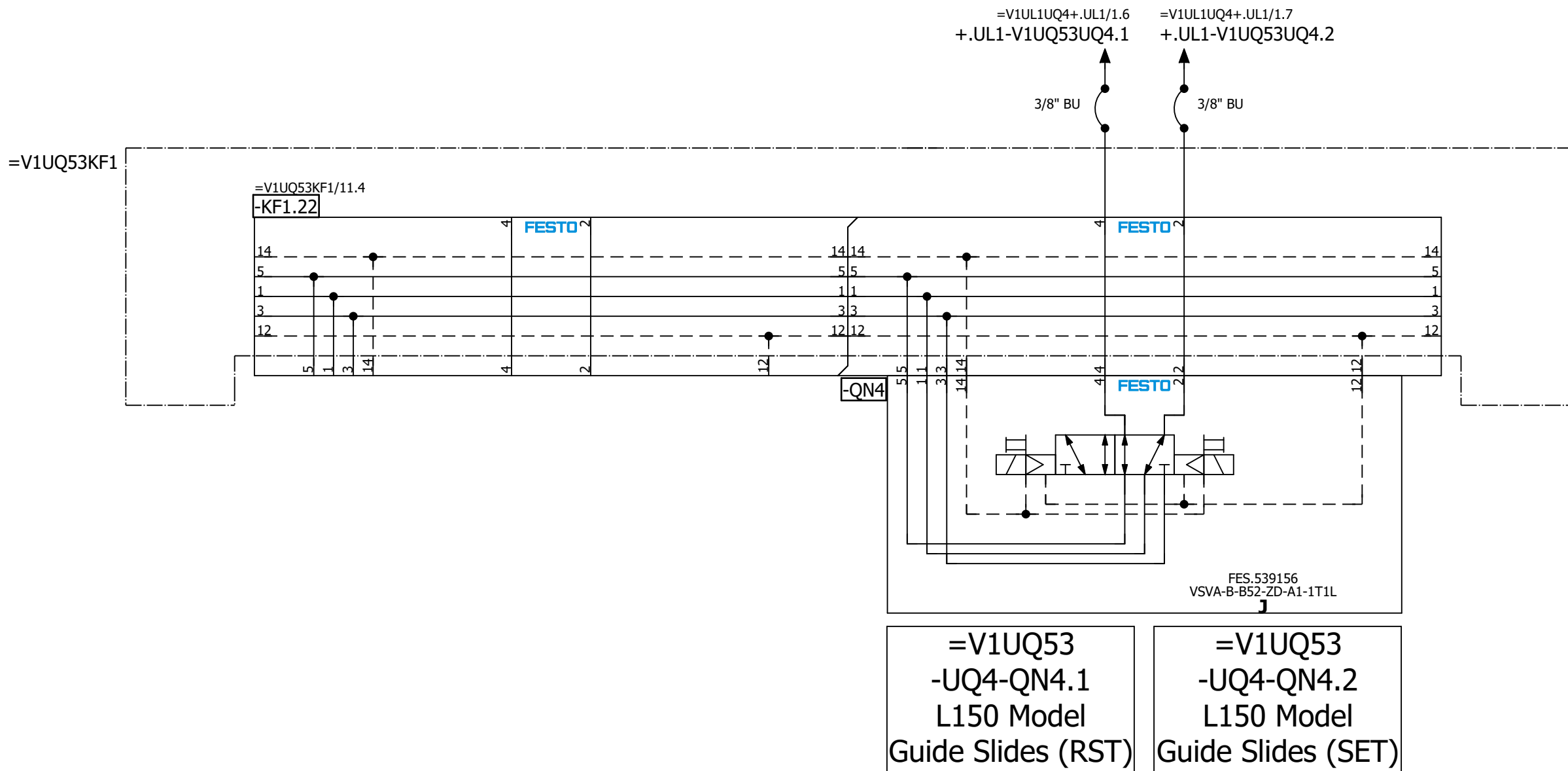



=V1UQ53KF1

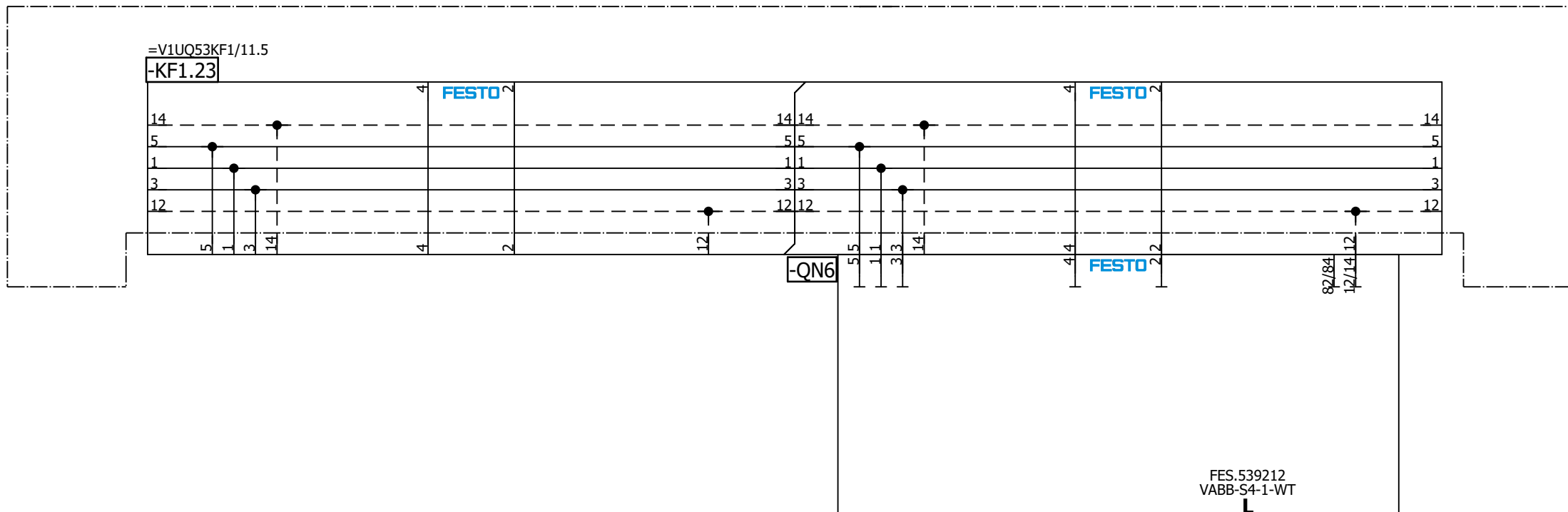

=V1UQ53UQ5/1

=V2AR31UQ41KF1+V2AR31UQ41/1

Date		12/20/2022		Volvo Trucks North America			Valiant TMS		Spare		Drawing name:		= V1UQ53UQ6	
Ed.		MKLEPADLO		P6700 Framing - Cell 2V01, KF1			Scale 1:1				Document type:		= 2V01&MFS-PNEU_KF1	
Appr				Replacement of		Replaced by				Project nr:		22-16152		
Modification	Date	Name	Original							MFS		Page 1		
												275		



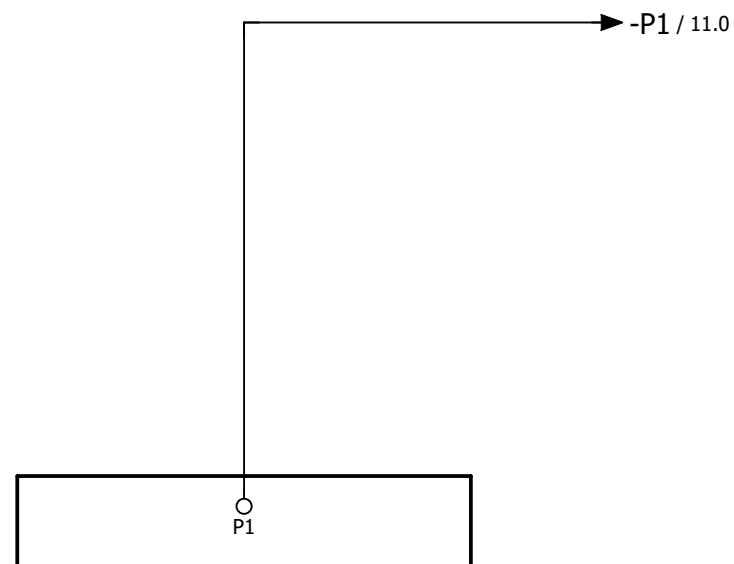

=V1UQ53UQ6+V1UQ53/1

		Date	1/3/2023	Volvo Trucks North America			Valiant TMS	AIR SUPPLY GRIPPER	Drawing name:		= V2AR31UQ41KF1
		Ed.	MKLEPADLO	P6700 Framing - Cell 2V01, KF1					=2V01&MFS-PNEU_KF1		+ V2AR31UQ41
Modification	Date	Name	Original	Replacement of	Replaced by	Scale 1:1			Document type:	Project nr:	Page
									MFS	22-16152	1
											275

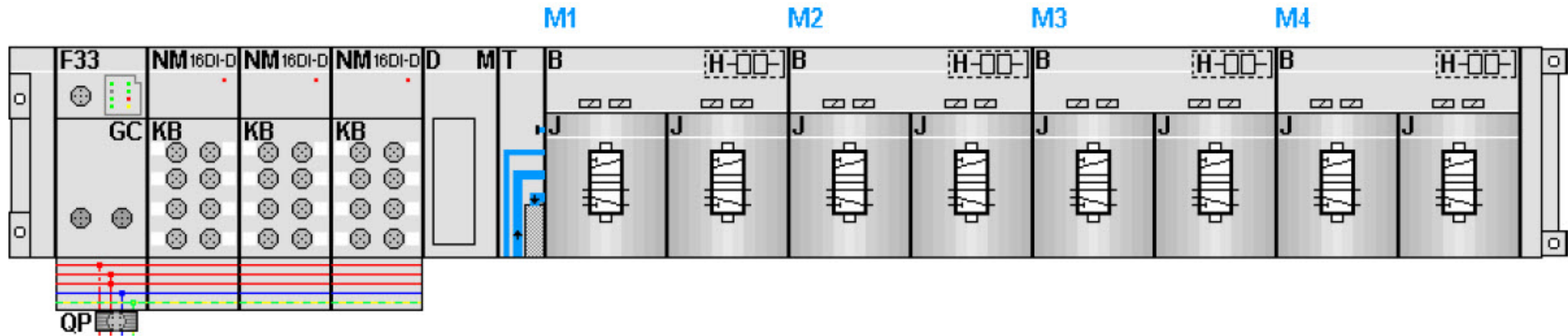

KF1.0

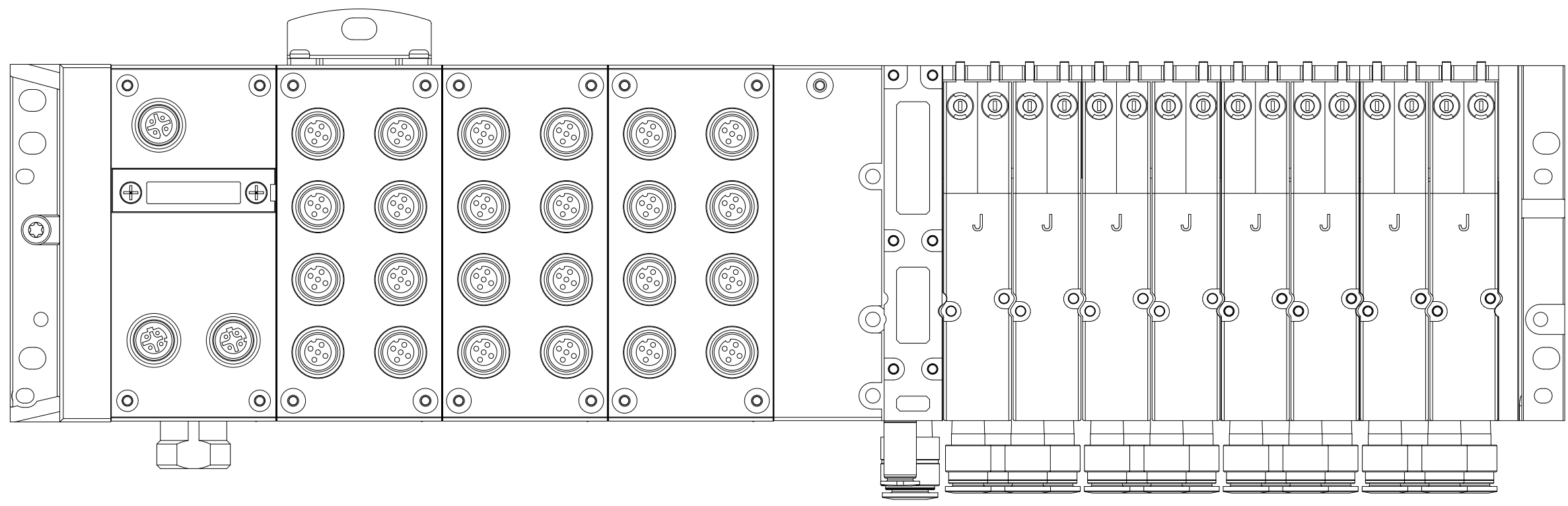

Date		1/17/2023		Volvo Trucks North America		Valiant TMS		AIR SUPPLY		Drawing name:		= V2AR31UQ41KF1	
Ed.		MKLEPADLO		P6700 Framing - Cell 2V01, KF1		Scale 1:1				Document type:		+ V2AR31UQ41	
Appr				Replacement of		Replaced by				Project nr:		Page	
Original										22-16152		5	
Modification		Date		Name						MFS		275	

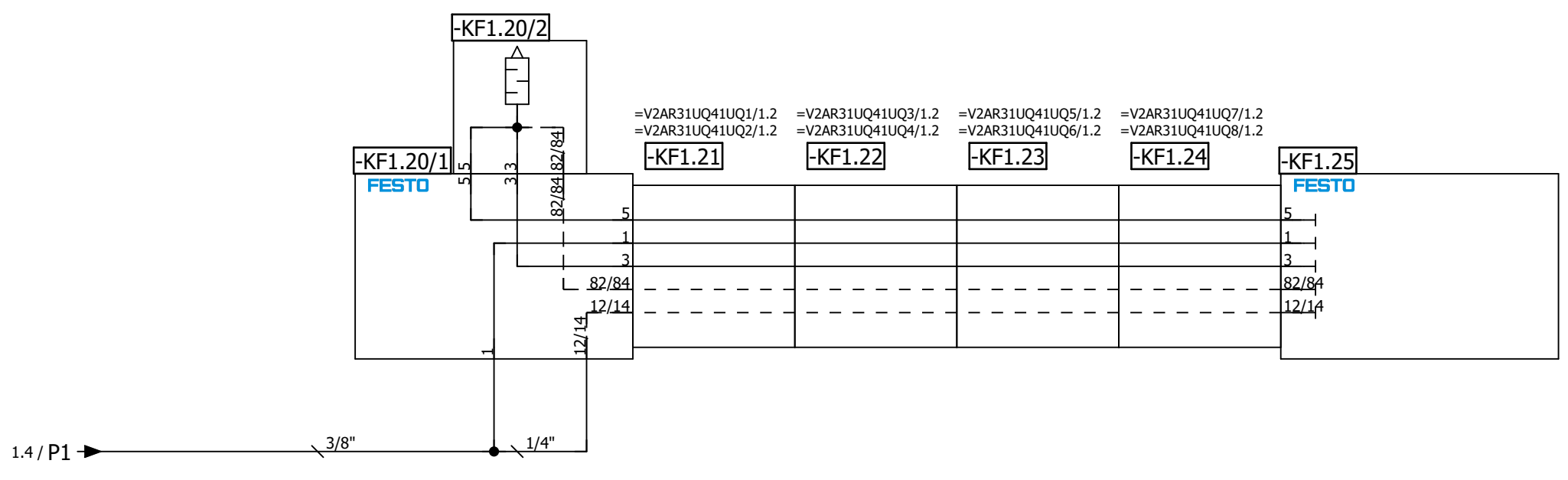
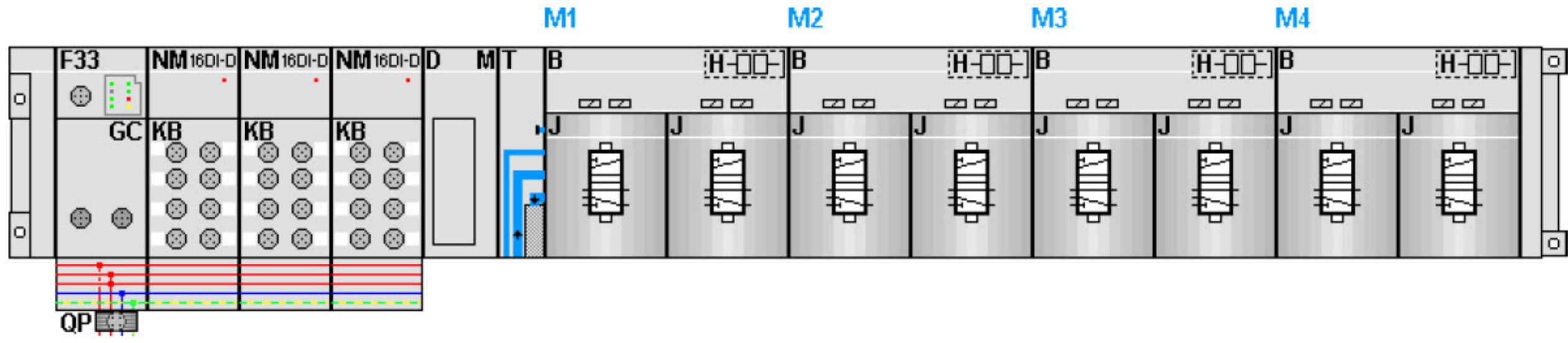



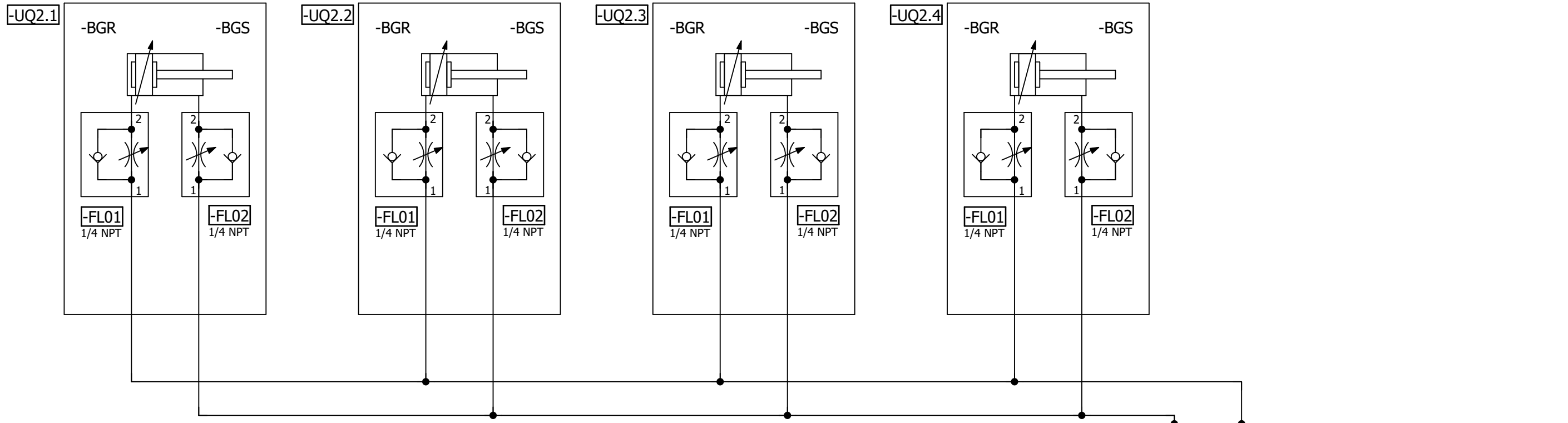

=V2AR31UQ41KF1

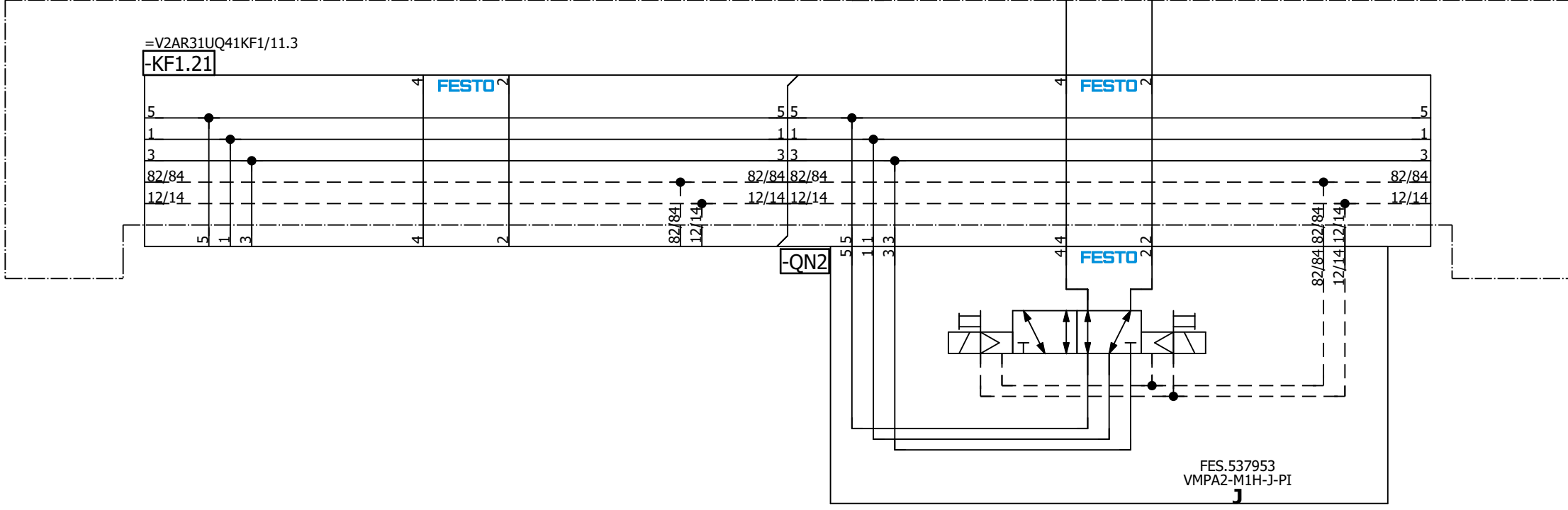

=V2AR31UQ41  
-UQ2-QN2.1  
Common  
Clamps (RST)

=V2AR31UQ41  
-UQ2-QN2.2  
Common  
Clamps (SET)

=V2AR31UQ41UQ1/1

=V2AR31UQ41UQ3/1

Date		1/17/2023		Volvo Trucks North America		Valiant TMS		Common Clamps		Drawing name:		= V2AR31UQ41UQ2	
Ed.		MKLEPADLO		P6700 Framing - Cell 2V01, KF1		Scale 1:1				Document type:		= V2AR31UQ41	
Appr.				Replacement of		Replaced by				Project nr:		Page	
Original										22-16152		1	
Modification		Date		Name						MFS		275	

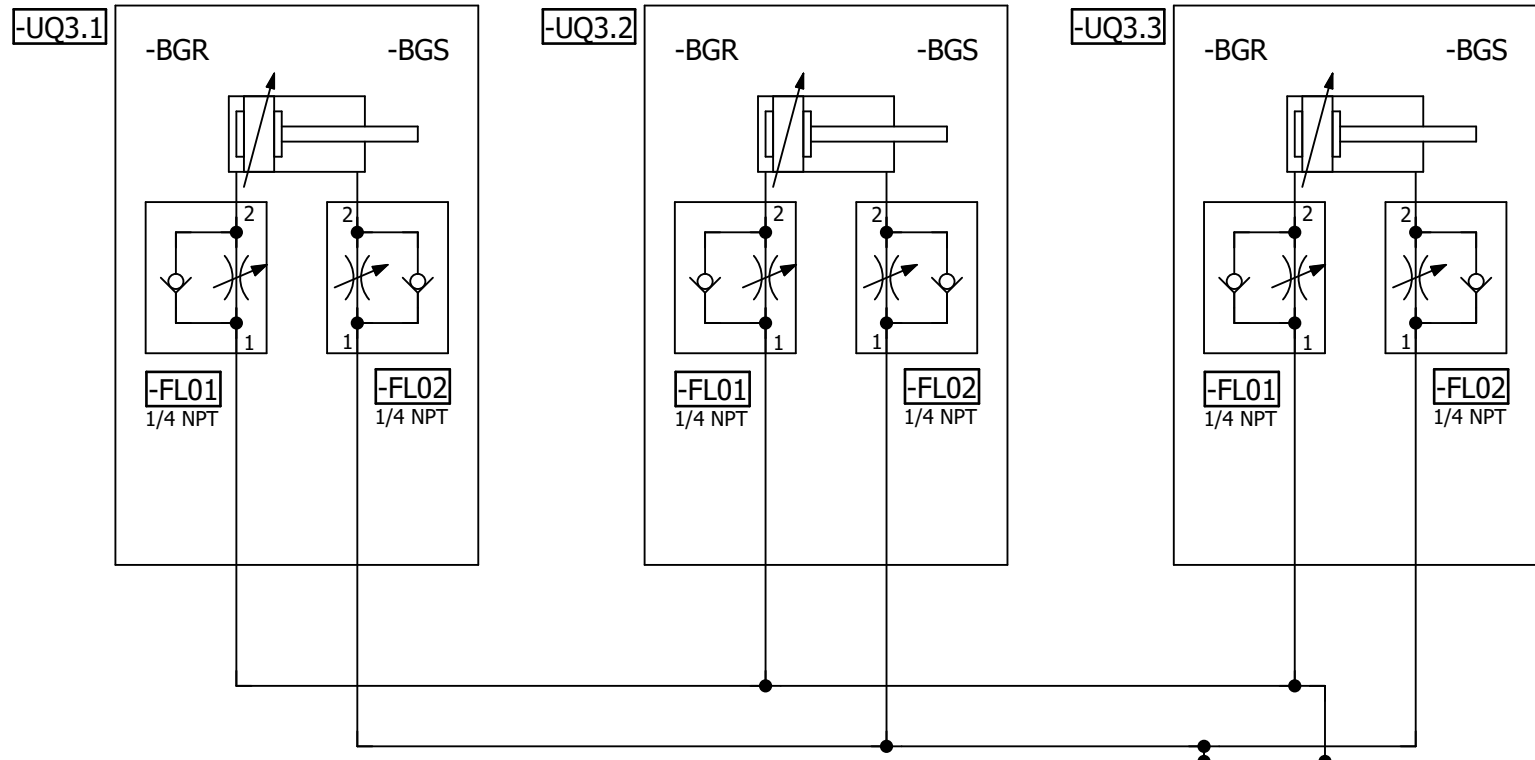

=V2AR31UQ41KF1

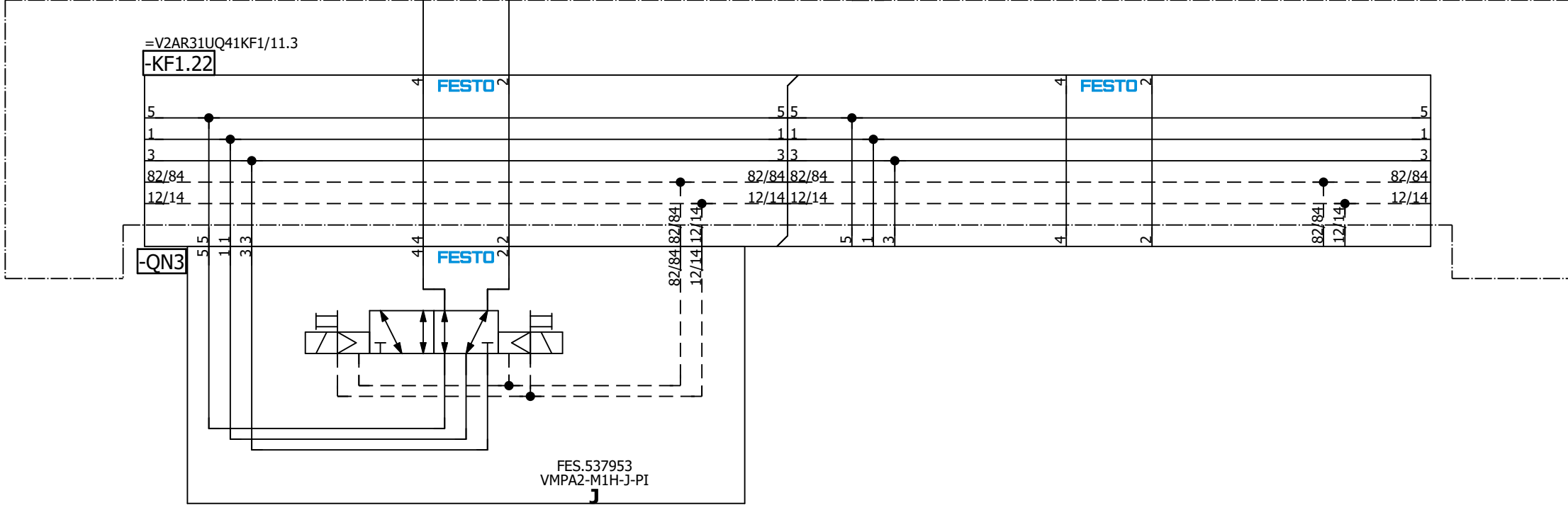

=V2AR31UQ41  
-UQ3-QN3.1  
L230 Model  
Clamps (RST)

=V2AR31UQ41  
-UQ3-QN3.2  
L230 Model  
Clamps (SET)

=V2AR31UQ41UQ2/1

=V2AR31UQ41UQ4/1

Date: 1/17/2023		Volvo Trucks North America		Valiant TMS		L230 Model Clamps		Drawing name: =V2AR31UQ41UQ3		= V2AR31UQ41UQ3	
Ed.: MKLEPADLO		P6700 Framing - Cell 2V01, KF1		Scale 1:1				Document type: MFS		Project nr: 22-16152	
Appr:		Replacement of		Replaced by				Page: 1		275	



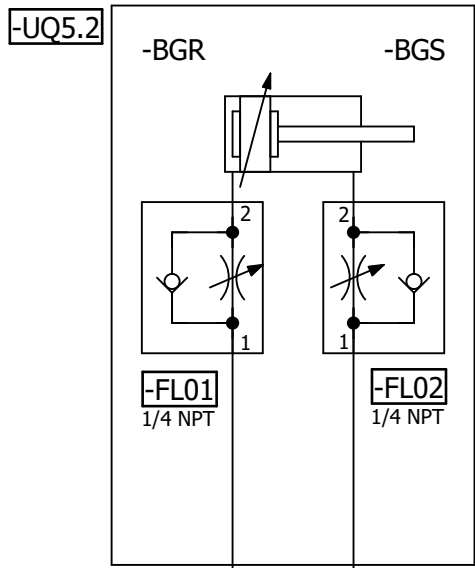
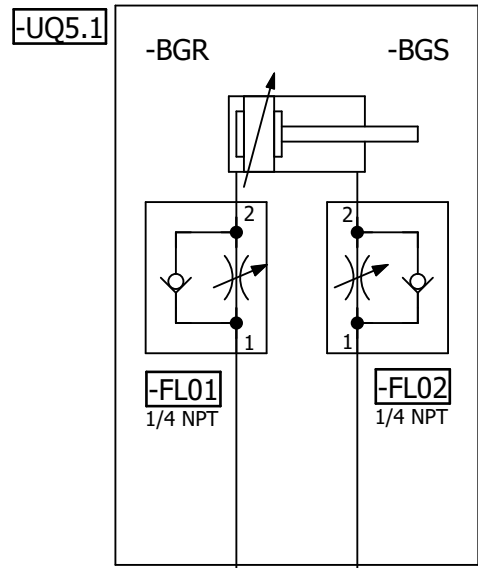

=V2AR31UQ41KF1

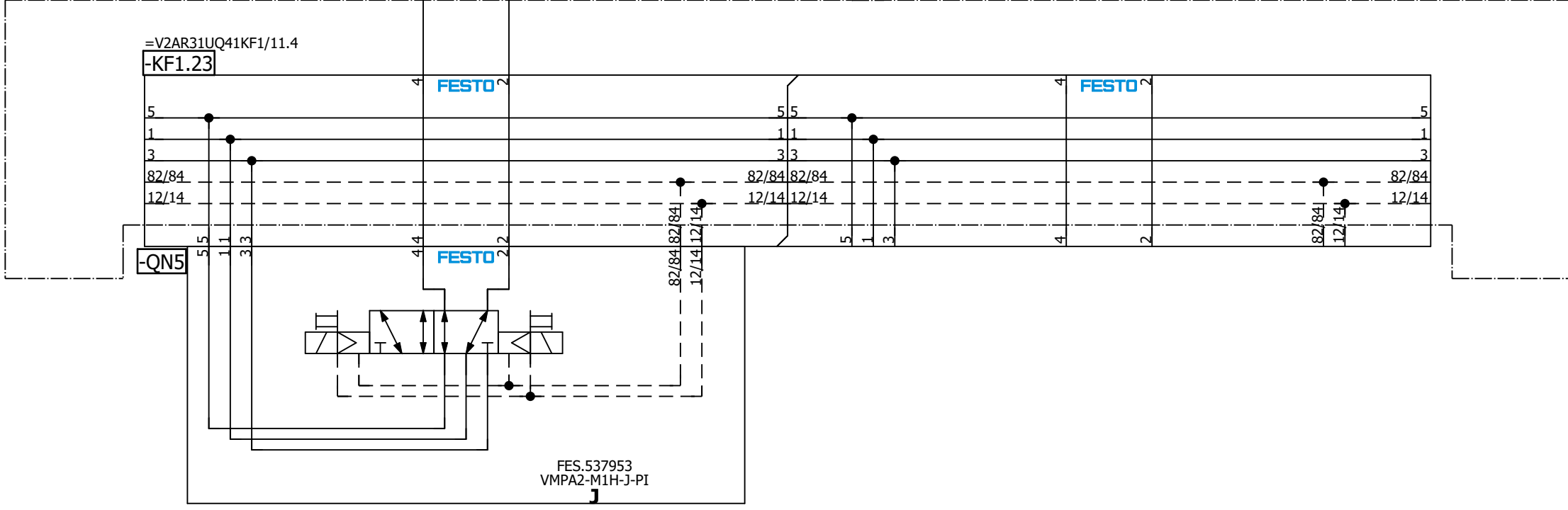

=V2AR31UQ41  
-UQ5-QN5.1  
L290 Model  
Clamps (RST)

=V2AR31UQ41  
-UQ5-QN5.2  
L290 Model  
Clamps (SET)

=V2AR31UQ41UQ4/1

=V2AR31UQ41UQ6/1

		Date	1/17/2023	Volvo Trucks North America		Valiant TMS		L290 Model Clamps		Drawing name: =2V01&MFS-PNEU_KF1		= V2AR31UQ41UQ5	
		Ed.	MKLEPADLO	P6700 Framing - Cell 2V01, KF1						Document type: MFS		Project nr: 22-16152	
		Appr		Replacement of				Replaced by		Scale 1:1			
Modification	Date	Name	Original									Page	
												275	



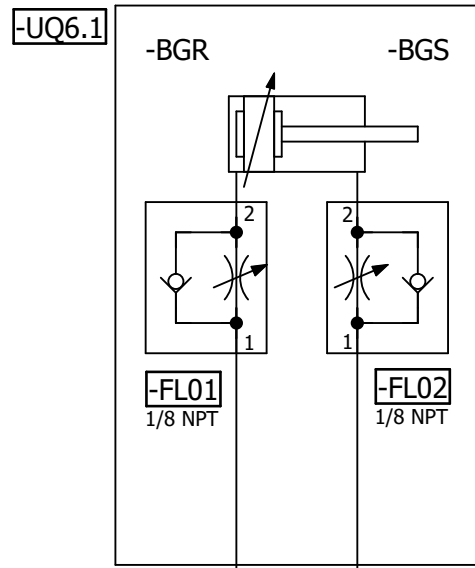

=V2AR31UQ41KF1

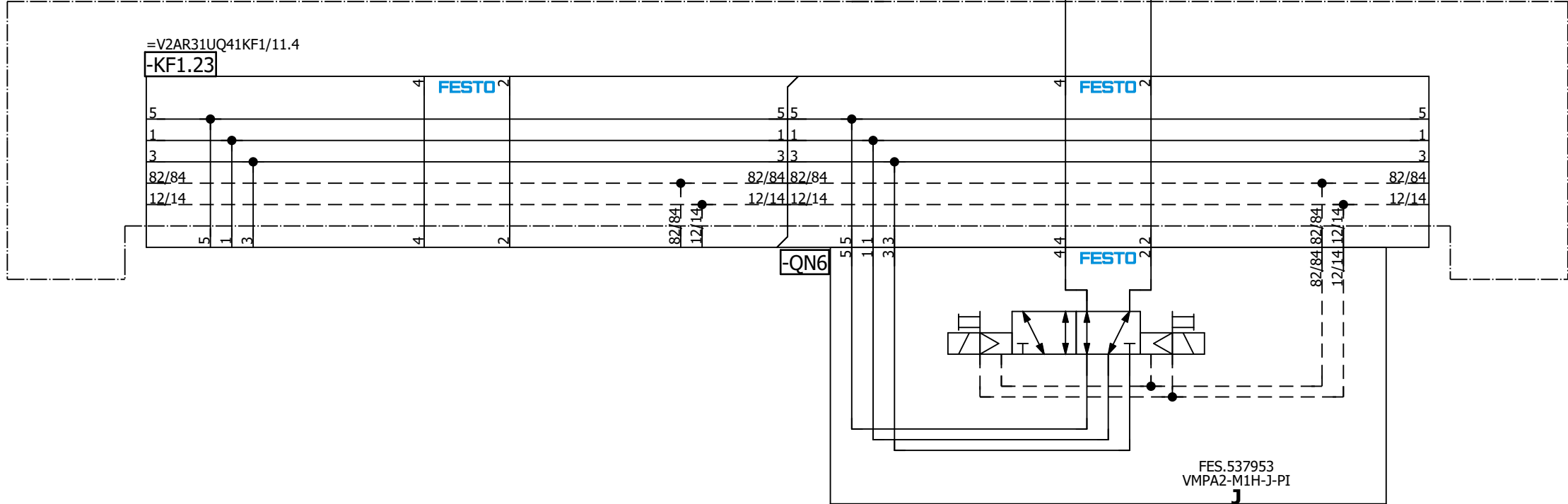

=V2AR31UQ41  
-UQ6-QN6.1  
L320 Model  
Shot Pin (RST)

=V2AR31UQ41  
-UQ6-QN6.2  
L320 Model  
Shot Pin (SET)

=V2AR31UQ41UQ5/1

			Date	1/17/2023
			Ed.	MKLEPADLO
			Appr.	
Modification	Date	Name	Original	

Volvo Trucks North America		
P6700 Framing - Cell 2V01, KF1		
Replacement of	Replaced by	

Valiant TMS	Scale 1:1
-------------	-----------

L320 Model Shot Pin
---------------------

Drawing name: =2V01&MFS-PNEU_KF1	
Document type: MFS	Project nr: 22-16152

= V2AR31UQ41UQ6 + V2AR31UQ41		Page 1
		275

=V2AR31UQ41UQ7/1

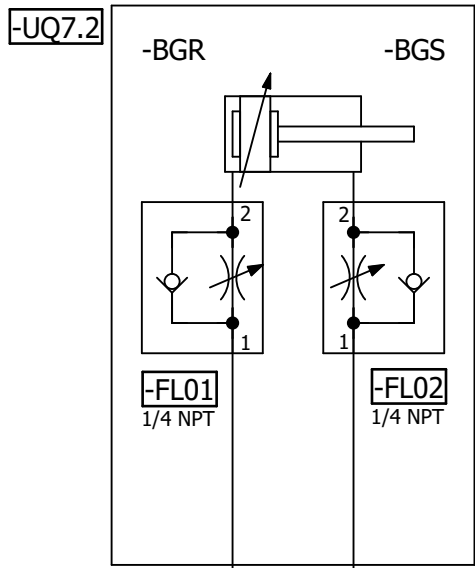
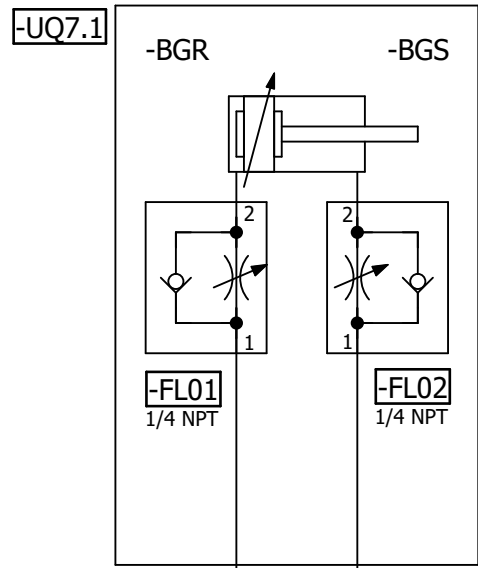

=V2AR31UQ41KF1

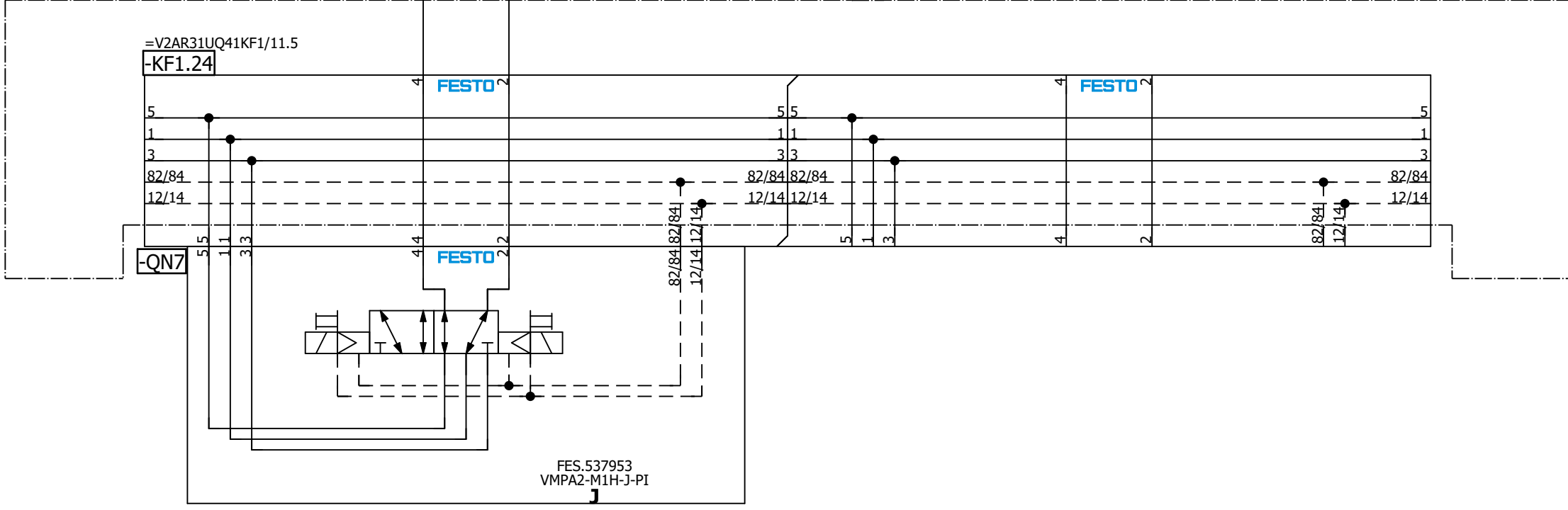

=V2AR31UQ41  
-UQ7-QN7.1  
L320 Model  
Clamps (RST)

=V2AR31UQ41  
-UQ7-QN7.2  
L320 Model  
Clamps (SET)

=V2AR31UQ41UQ6/1

=V2AR31UQ41UQ8/1

		Date	1/17/2023	Volvo Trucks North America		Valiant TMS		L320 Model Clamps		Drawing name: =2V01&MFS-PNEU_KF1		= V2AR31UQ41UQ7 + V2AR31UQ41	
		Ed.	MKLEPADLO	P6700 Framing - Cell 2V01, KF1		Scale 1:1				Document type: MFS		Project nr: 22-16152	
Modification	Date	Name	Original	Replacement of	Replaced by							Page	1
													275

=V2AR31UQ41KF1

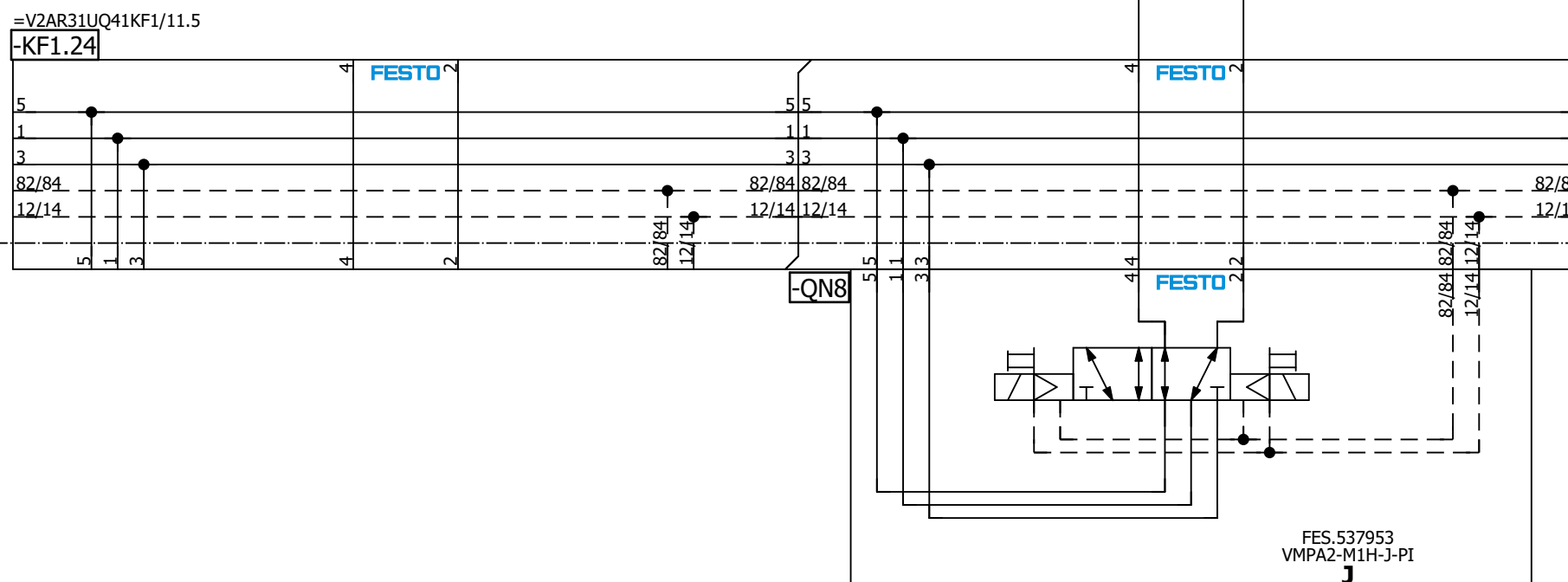

=V2AR31UQ41  
-UQ8-QN8.1  
Spare  
(RST)

=V2AR31UQ41  
-UQ8-QN8.2  
Spare  
(SET)

=V2AR31UQ42KF1+.AR31UQ42/1

=V2AR31UQ41UQ7/1

Date		12/20/2022		Volvo Trucks North America		Valiant TMS		Spare		Drawing name:		= V2AR31UQ41UQ8	
Ed.		MKLEPADLO		P6700 Framing - Cell 2V01, KF1		Scale 1:1				Document type:		= V2AR31UQ41	
Appr.				Replacement of		Replaced by				Project nr:		Page	
Original										22-16152		1	
Modification		Date		Name		Original				MFS		275	



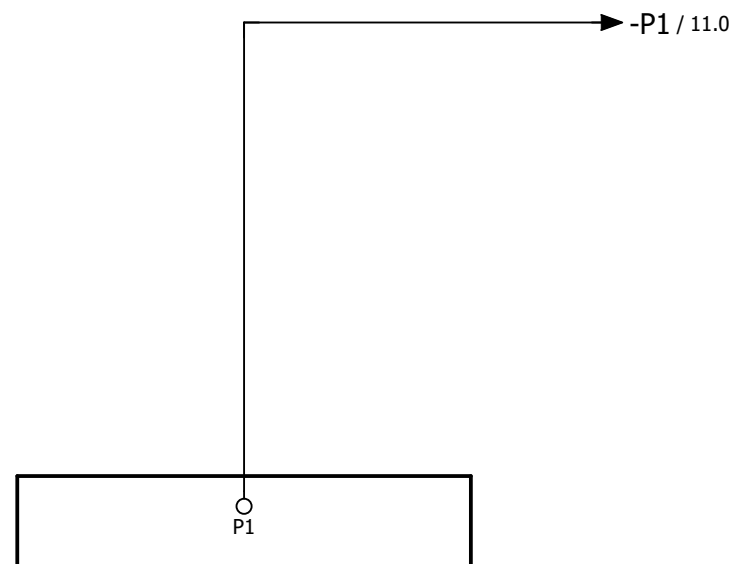

=V2AR31UQ41UQ8+.AR31UQ41/1

		Date	1/3/2023	Volvo Trucks North America			Valiant TMS	AIR SUPPLY GRIPPER	Drawing name:		= V2AR31UQ42KF1
		Ed.	MKLEPADLO	P6700 Framing - Cell 2V01, KF1					=2V01&MFS-PNEU_KF1		+ V2AR31UQ42
		Appr		Replacement of		Replaced by	Scale 1:1		Document type:	Project nr:	Page
Modification	Date	Name	Original						MFS	22-16152	1
											275





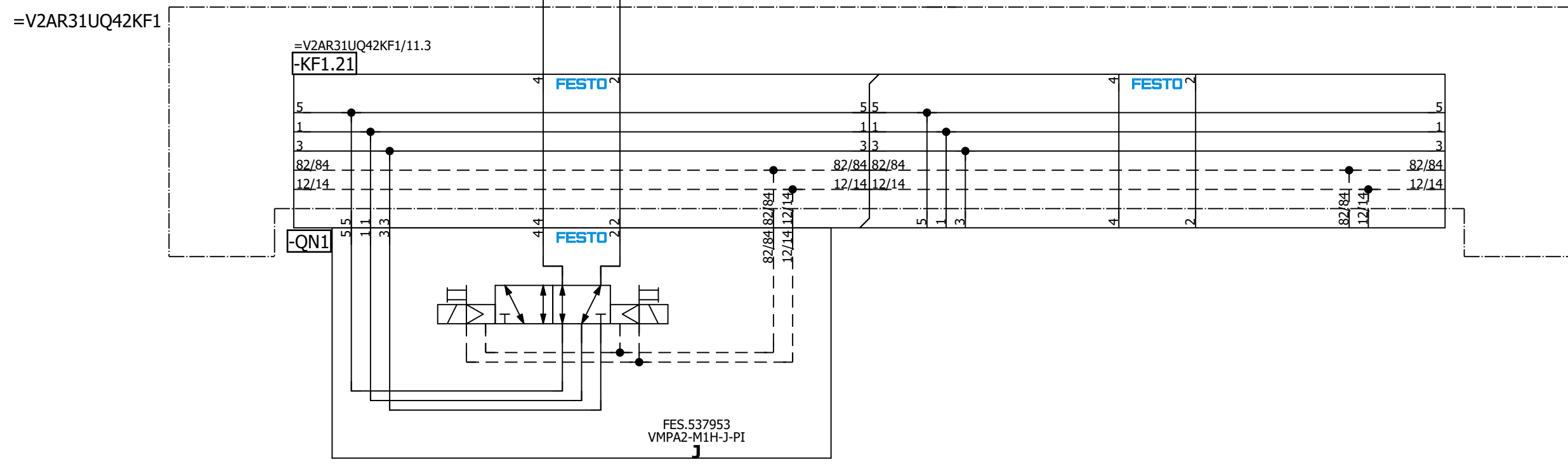
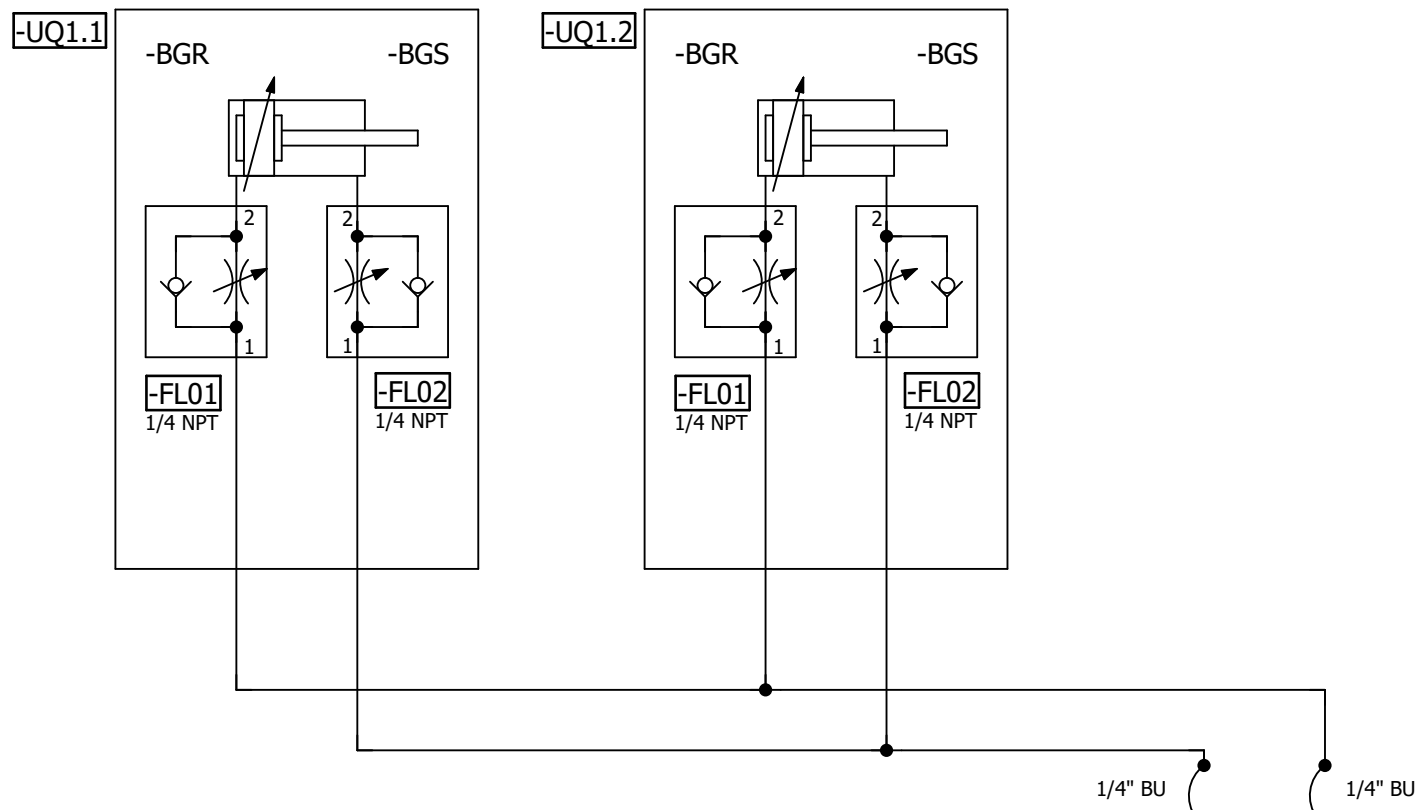

=V2AR31UQ42  
-UQ1-QN1.1  
Common  
Clamps (RST)

=V2AR31UQ42  
-UQ1-QN1.2  
Common  
Clamps (SET)

=V2AR31UQ42KF1/11

=V2AR31UQ42UQ2/1

Date: 1/17/2023		Volvo Trucks North America		Valiant TMS		Drawing name: =2V01&MFS-PNEU_KF1		= V2AR31UQ42UQ1	
Ed.: MKLEPADLO		P6700 Framing - Cell 2V01, KF1		Common Clamps		Document type: MFS		+ V2AR31UQ42	
Appr:		Replacement of		Scale 1:1		Project nr: 22-16152		Page 1	
Original		Replaced by						275	

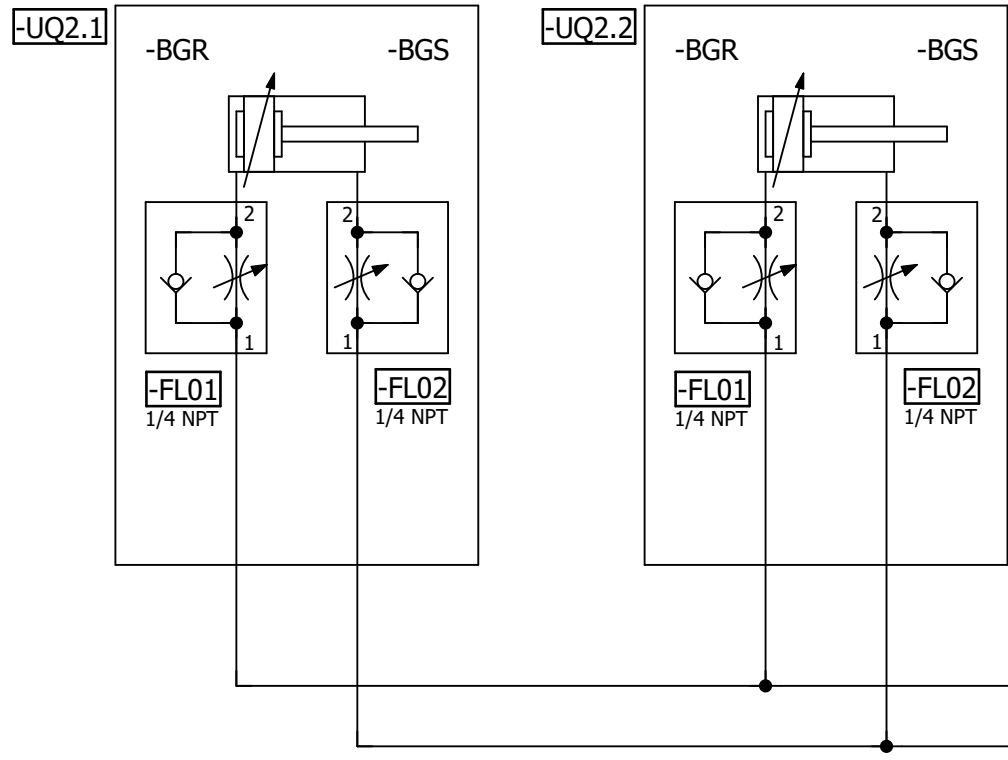

=V2AR31UQ42KF1

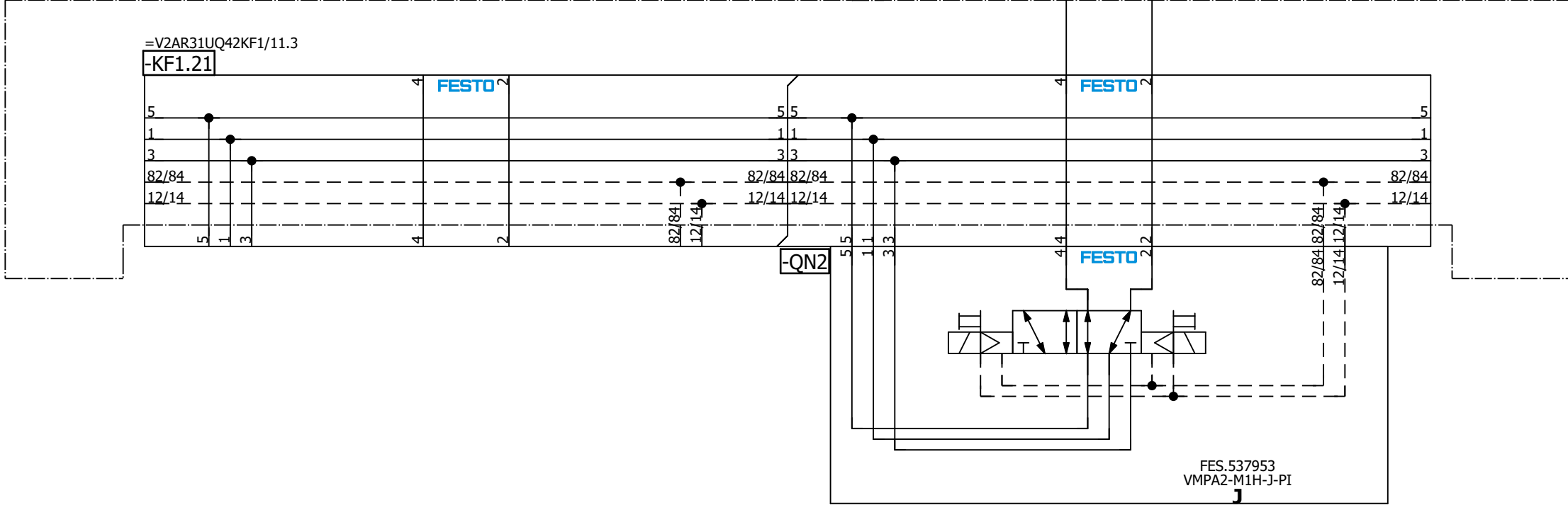

=V2AR31UQ42  
-UQ2-QN2.1  
L150 Model  
Clamps (RST)

=V2AR31UQ42  
-UQ2-QN2.2  
L150 Model  
Clamps (SET)

=V2AR31UQ42UQ1/1

=V2AR31UQ42UQ3/1

			Date	1/17/2023	Volvo Trucks North America		Valiant TMS	L150 Model Clamps	Drawing name:		= V2AR31UQ42UQ2
			Ed.	MKLEPADLO	P6700 Framing - Cell 2V01, KF1				=2V01&MFS-PNEU_KF1		+ V2AR31UQ42
			Appr.		Replacement of		Scale 1:1	Document type:		Project nr:	Page
Modification	Date	Name	Original		Replaced by			MFS	22-16152		1
											275



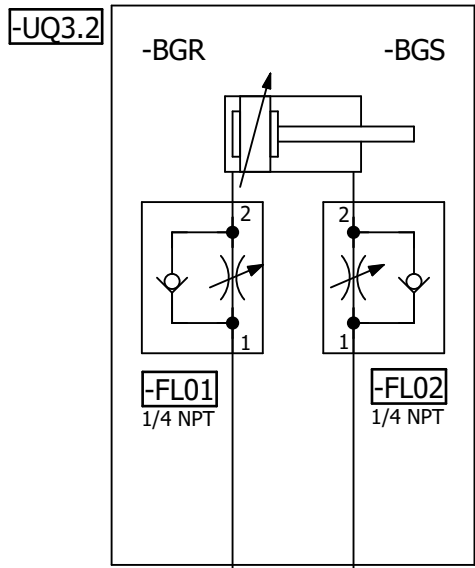
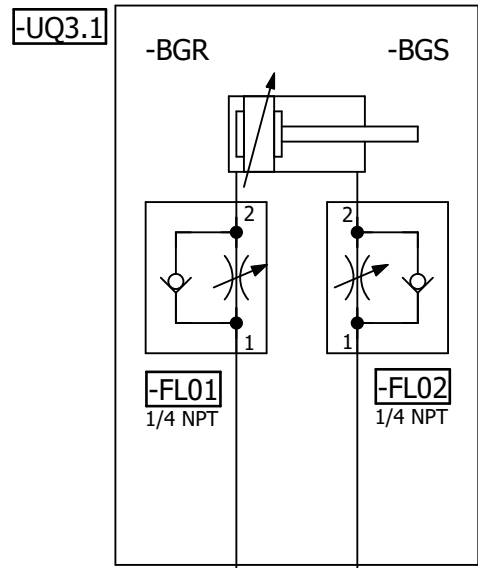

=V2AR31UQ42KF1

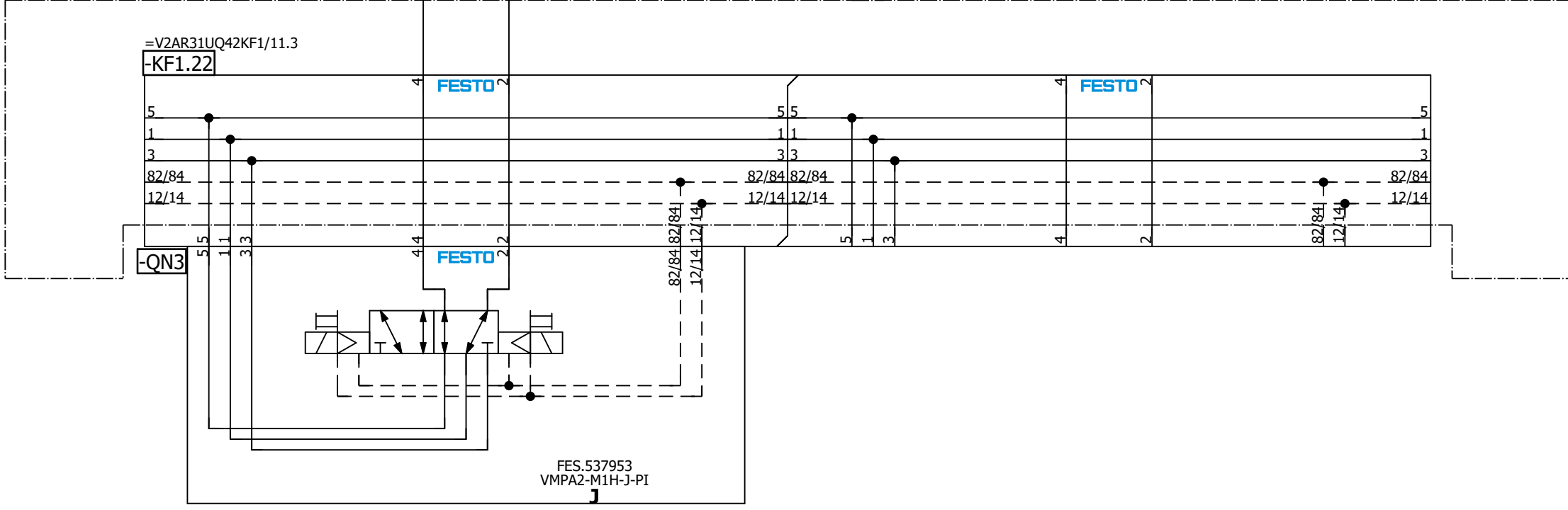

=V2AR31UQ42  
-UQ3-QN3.1  
L230/290/320  
Clamps (RST)

=V2AR31UQ42  
-UQ3-QN3.2  
L230/290/320  
Clamps (SET)

=V2AR31UQ42UQ2/1

=V2AR31UQ42UQ4/1

Date: 1/17/2023		Volvo Trucks North America		Valiant TMS		L230/290/320 Model Clamps		Drawing name: =V2AR31UQ42UQ3		= V2AR31UQ42UQ3	
Ed.: MKLEPADLO		P6700 Framing - Cell 2V01, KF1		Scale 1:1				Document type: MFS		Project nr: 22-16152	
Appr:		Replacement of		Replaced by				Page: 1		275	





M1

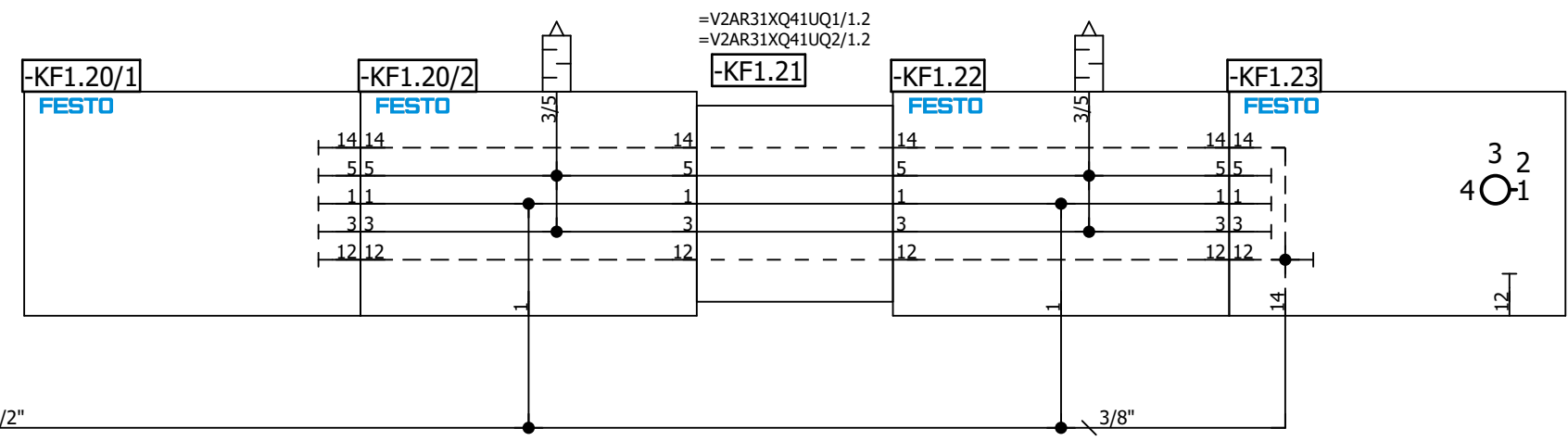
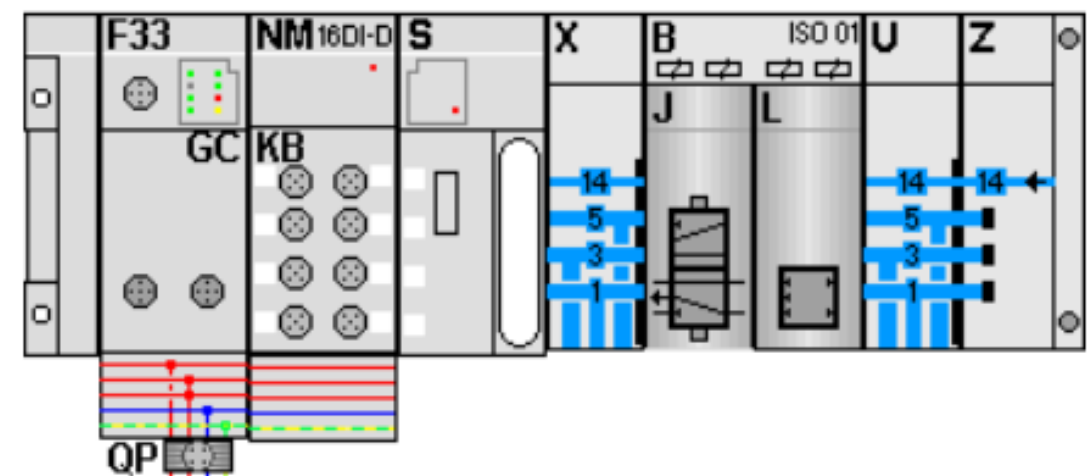

=KH0+KH0/1.0 / +KH0-V2AR31XQ41

5

=V2AR31XQ41UQ1/1

Date		1/17/2023	Volvo Trucks North America		Valiant TMS	AIR SUPPLY	Drawing name:		= V2AR31XQ41KF1			
Ed.		MKLEPADLO	P6700 Framing - Cell 2V01, KF1				=2V01&MFS-PNEU_KF1		+ V2AR31KF1			
Appr			Replacement of		Scale 1:1	Document type:		MFS	Project nr:	22-16152	Page	11
Original			Replaced by									275

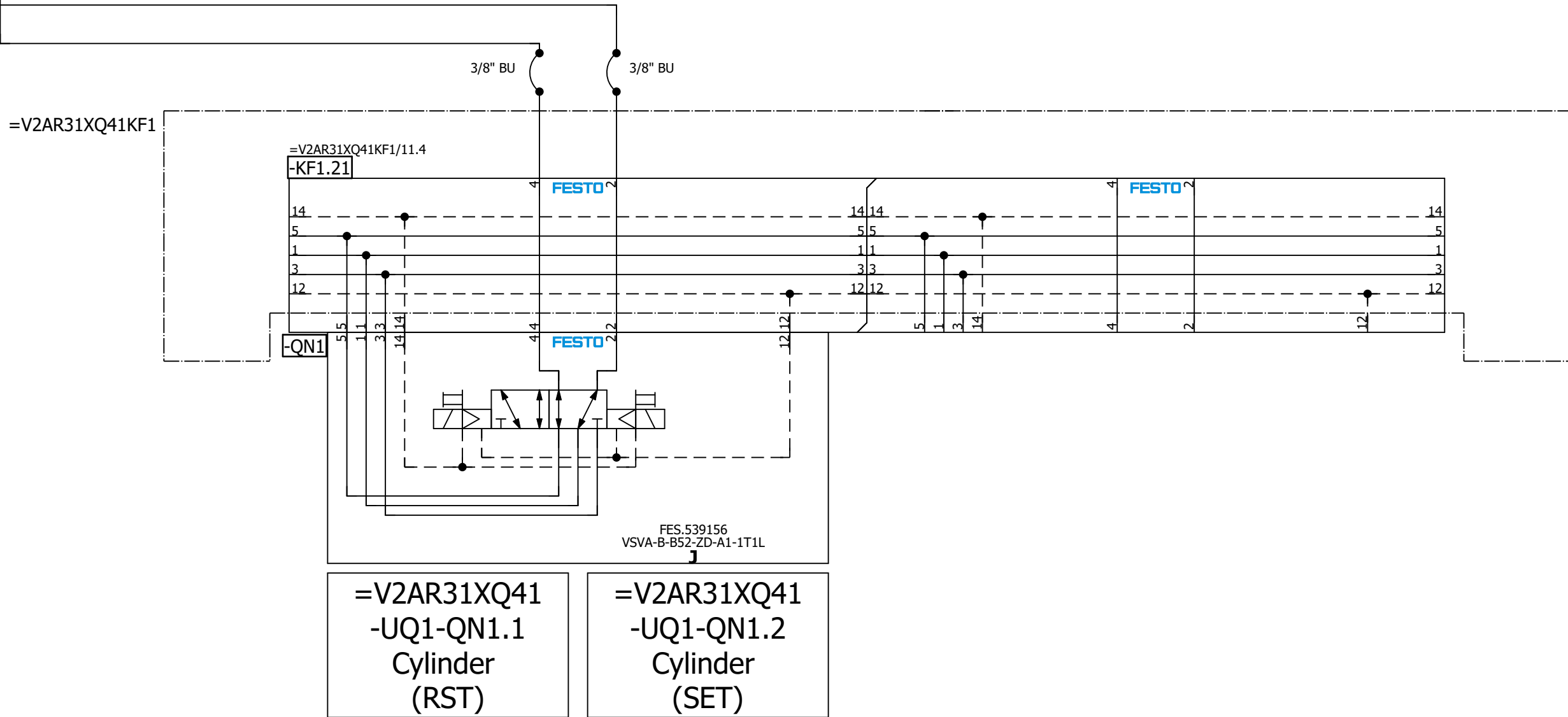
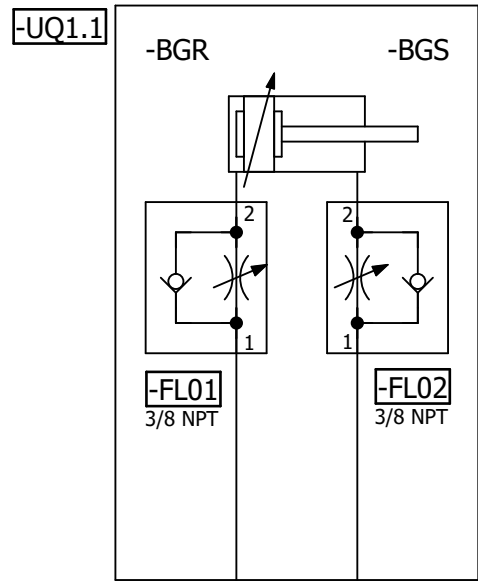

=V2AR31XQ41KF1/11

=V2AR31XQ41UQ2/1

Date		1/17/2023	Volvo Trucks North America		Valiant TMS	Cylinder	Drawing name:		= V2AR31XQ41UQ1
Ed.		MKLEPADLO	P6700 Framing - Cell 2V01, KF1				=2V01&MFS-PNEU_KF1		+ V2AR31KF1
Appr			Replacement of		Scale 1:1		Document type:		MFS
Original			Replaced by				Project nr:		22-16152
Modification	Date	Name	Original				Page		1
									275



=V2AR31XQ41KF1

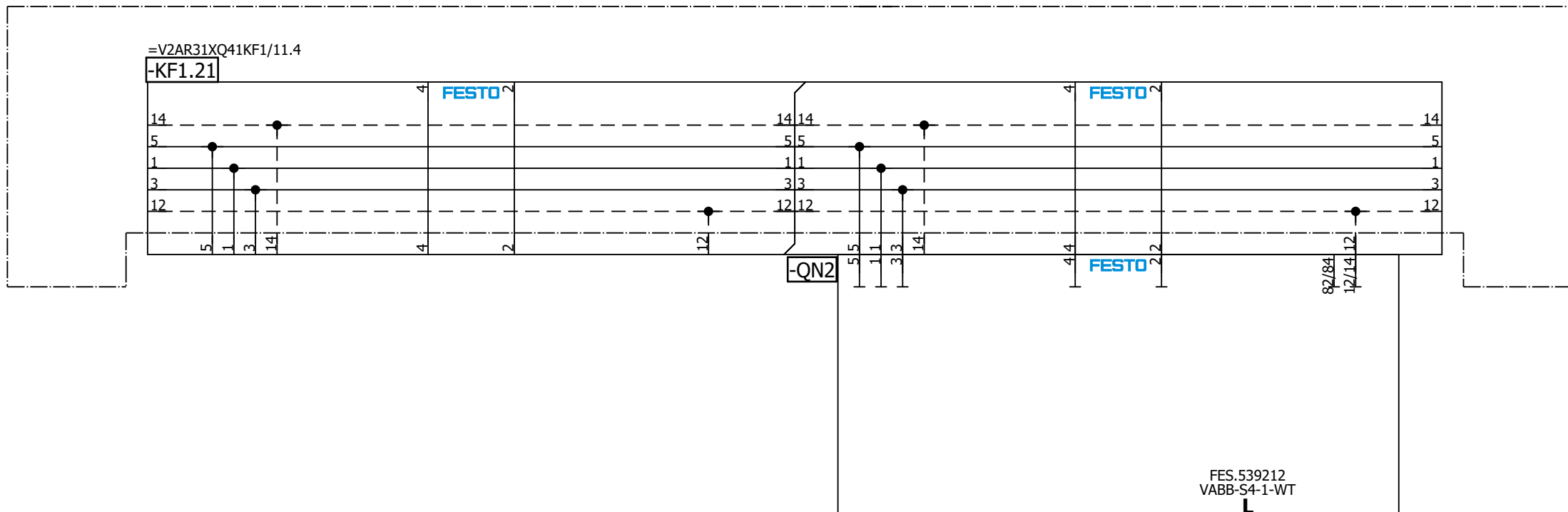

=V2AR31XQ41UQ1/1

=V2AR32UQ41KF1+.AR32UQ41/1

Date		12/20/2022		Volvo Trucks North America		Valiant TMS		Spare		Drawing name:		= V2AR31XQ41UQ2	
Ed.		MKLEPADLO		P6700 Framing - Cell 2V01, KF1		Scale 1:1				Document type:		= V2AR31KF1	
Appr.				Replacement of		Replaced by				Project nr:		Page	
Original										22-16152		1	
Modification		Date		Name		Original				MFS		275	

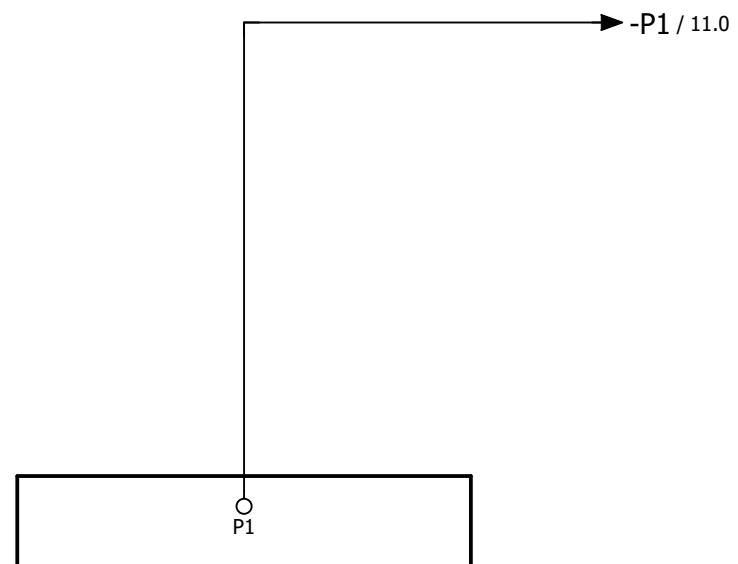

=V2AR31XQ41UQ2+.AR31KF1/1

		Date	1/3/2023	Volvo Trucks North America		Valiant TMS	AIR SUPPLY GRIPPER	Drawing name:		= V2AR32UQ41KF1
		Ed.	MKLEPADLO	P6700 Framing - Cell 2V01, KF1				=2V01&MFS-PNEU_KF1		+ V2AR32UQ41
Modification	Date	Name	Original	Replacement of	Replaced by	Scale 1:1		Document type:	Project nr:	Page
								MFS	22-16152	1
										275

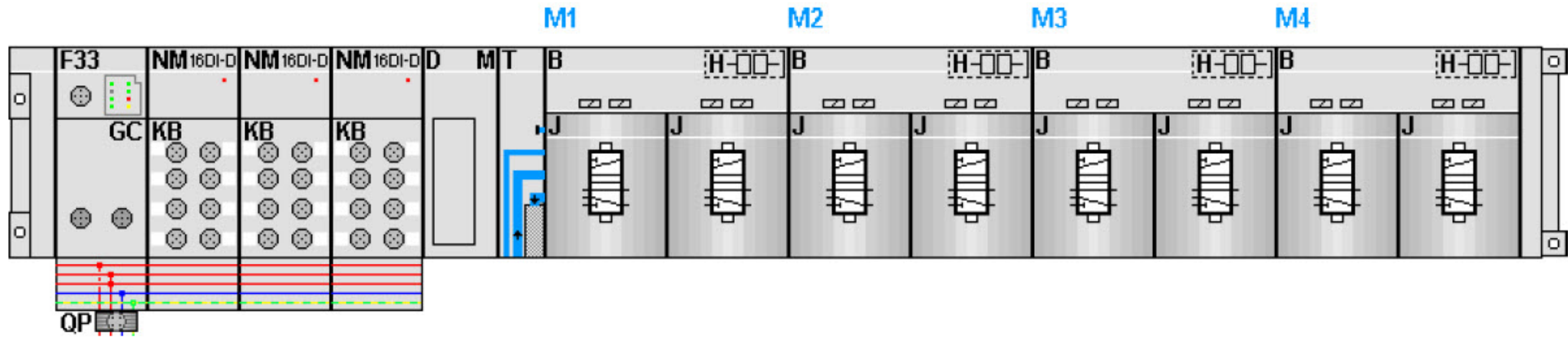

KF1.0

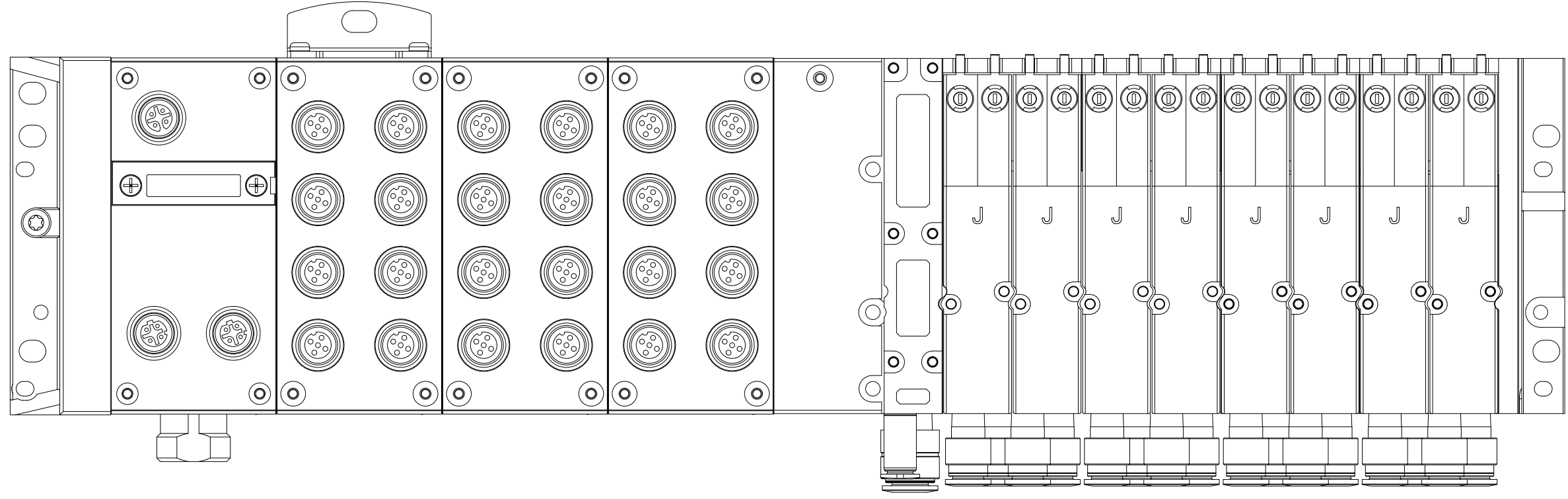

Date		1/17/2023		Volvo Trucks North America		Valiant TMS		AIR SUPPLY		Drawing name:		= V2AR32UQ41KF1	
Ed.		MKLEPADLO		P6700 Framing - Cell 2V01, KF1		Scale 1:1				Document type:		+ V2AR32UQ41	
Appr.				Replacement of		Replaced by				Project nr:		Page	
Original										MFS		5	
										22-16152		275	



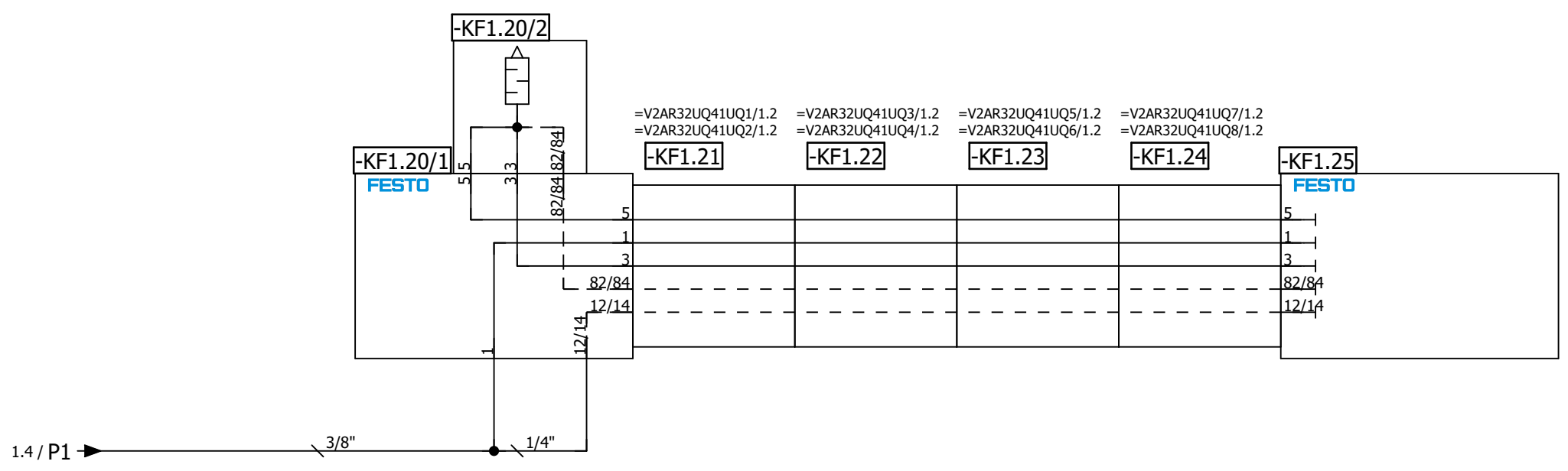
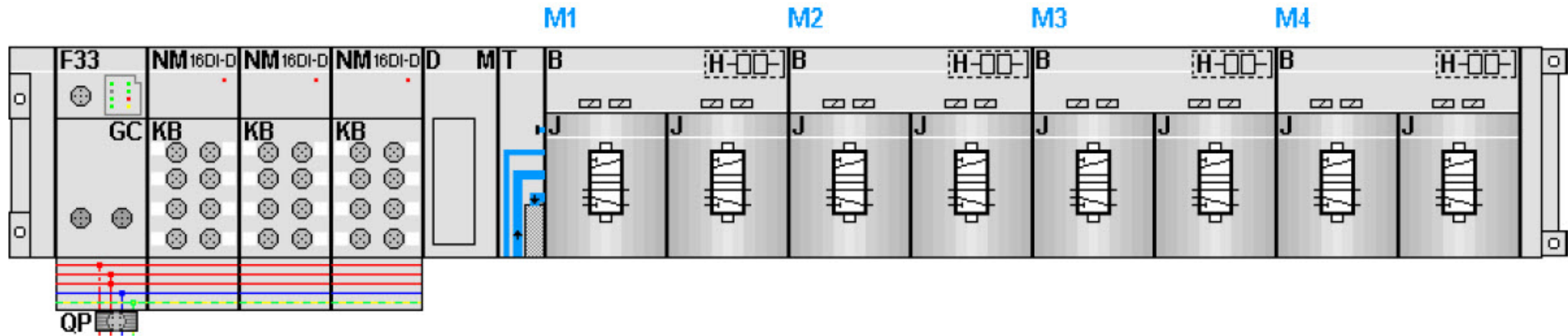





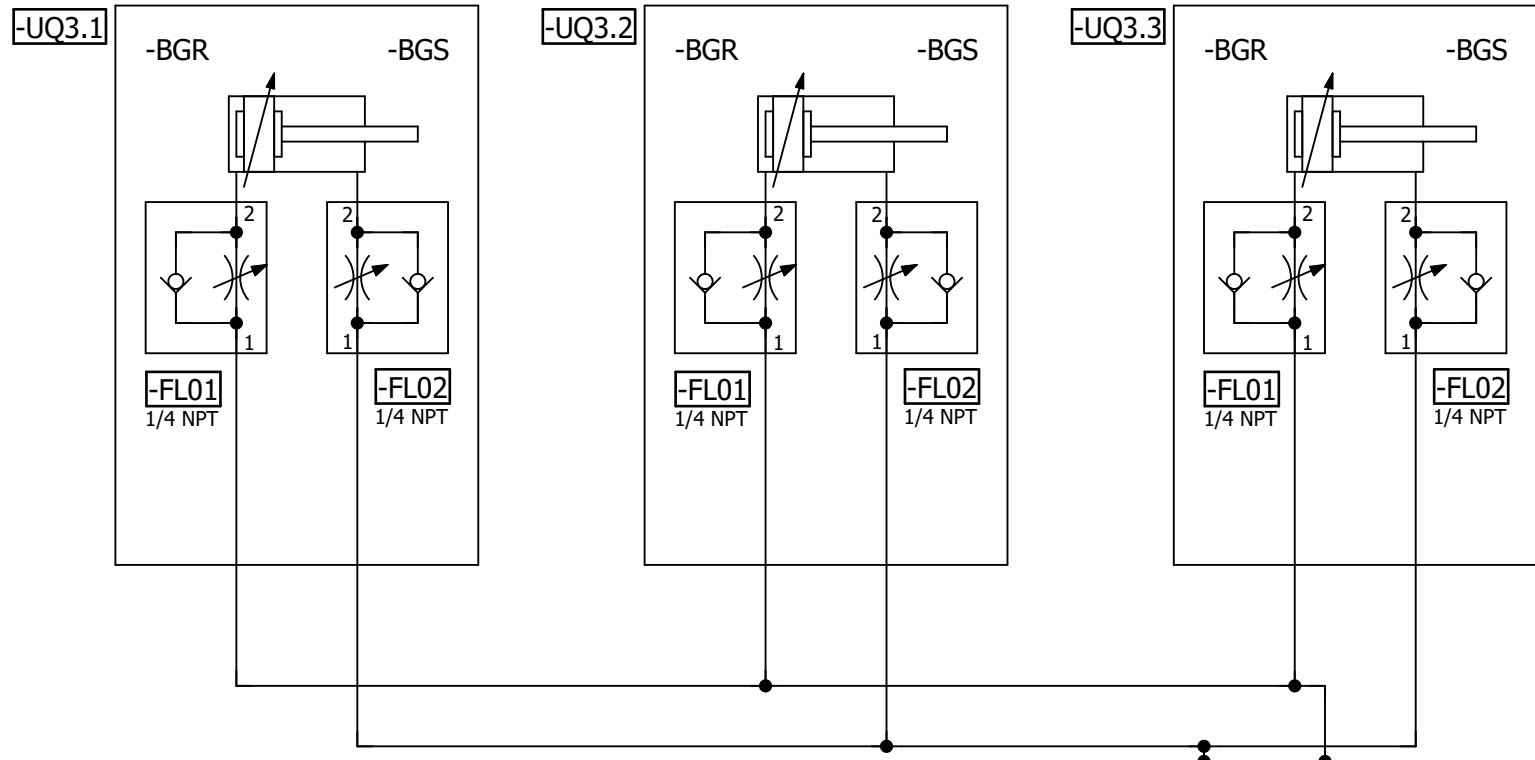

=V2AR32UQ41KF1

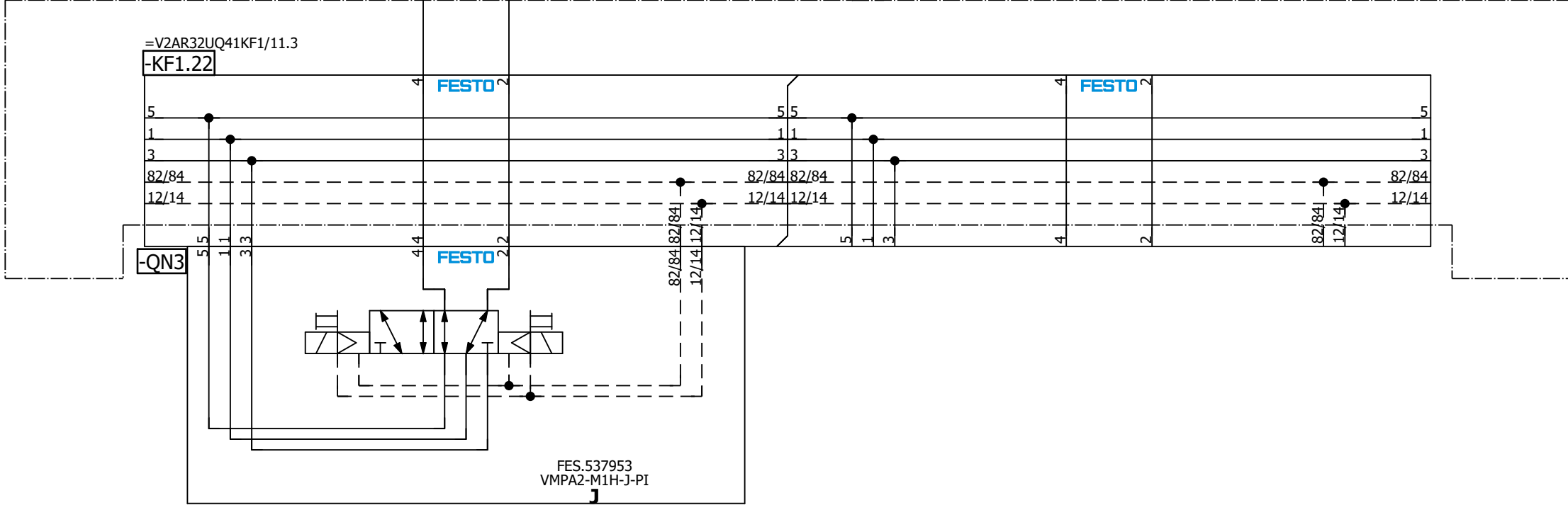

=V2AR32UQ41  
-UQ3-QN3.1  
L230 Model  
Clamps (RST)

=V2AR32UQ41  
-UQ3-QN3.2  
L230 Model  
Clamps (SET)

=V2AR32UQ41UQ2/1

=V2AR32UQ41UQ4/1

Date: 1/17/2023		Volvo Trucks North America		Valiant TMS		Drawing name: =V2AR32UQ41UQ3		= V2AR32UQ41UQ3	
Ed.: MKLEPADLO		P6700 Framing - Cell 2V01, KF1		L230 Model Clamps		Document type: MFS		+ V2AR32UQ41	
Appr:		Replacement of		Scale 1:1		Project nr: 22-16152		Page 1	
Original		Replaced by						275	



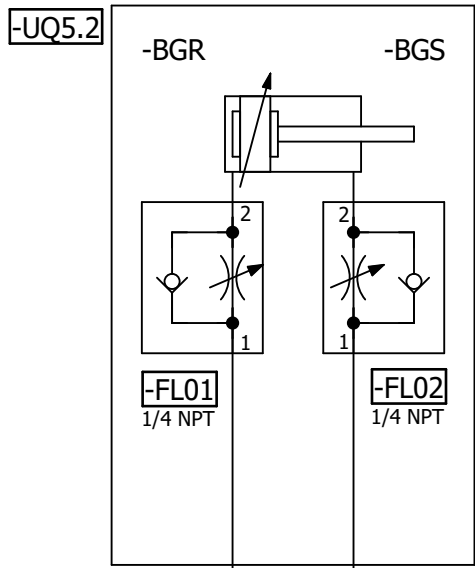
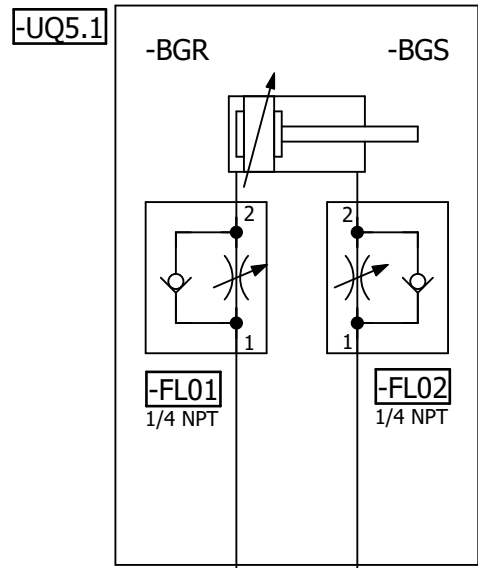

=V2AR32UQ41KF1

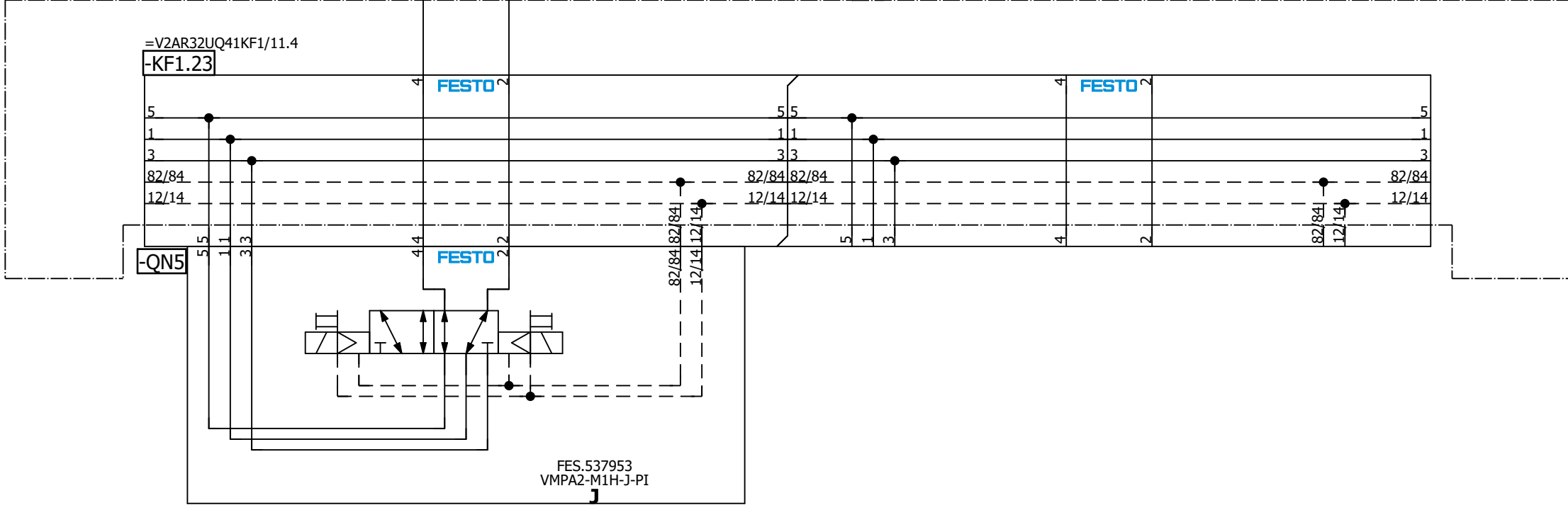

=V2AR32UQ41  
-UQ5-QN5.1  
L290 Model  
Clamps (RST)

=V2AR32UQ41  
-UQ5-QN5.2  
L290 Model  
Clamps (SET)

=V2AR32UQ41UQ4/1

=V2AR32UQ41UQ6/1

		Date	1/17/2023	Volvo Trucks North America		Valiant TMS		L290 Model Clamps		Drawing name: =2V01&MFS-PNEU_KF1		= V2AR32UQ41UQ5	
		Ed.	MKLEPADLO	P6700 Framing - Cell 2V01, KF1				Scale 1:1		Document type: MFS		Project nr: 22-16152	
		Appr		Replacement of						Replaced by			
Modification	Date	Name	Original									275	

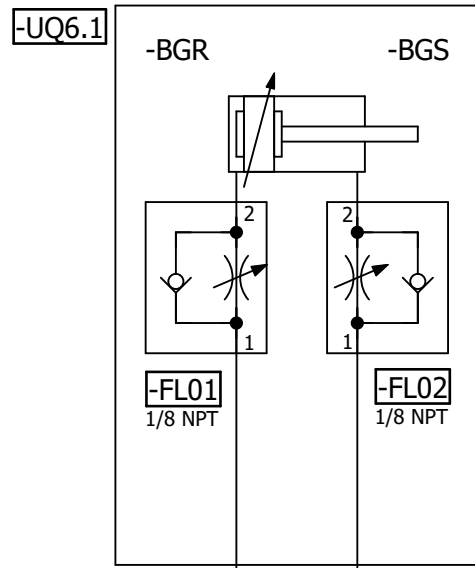

=V2AR32UQ41KF1

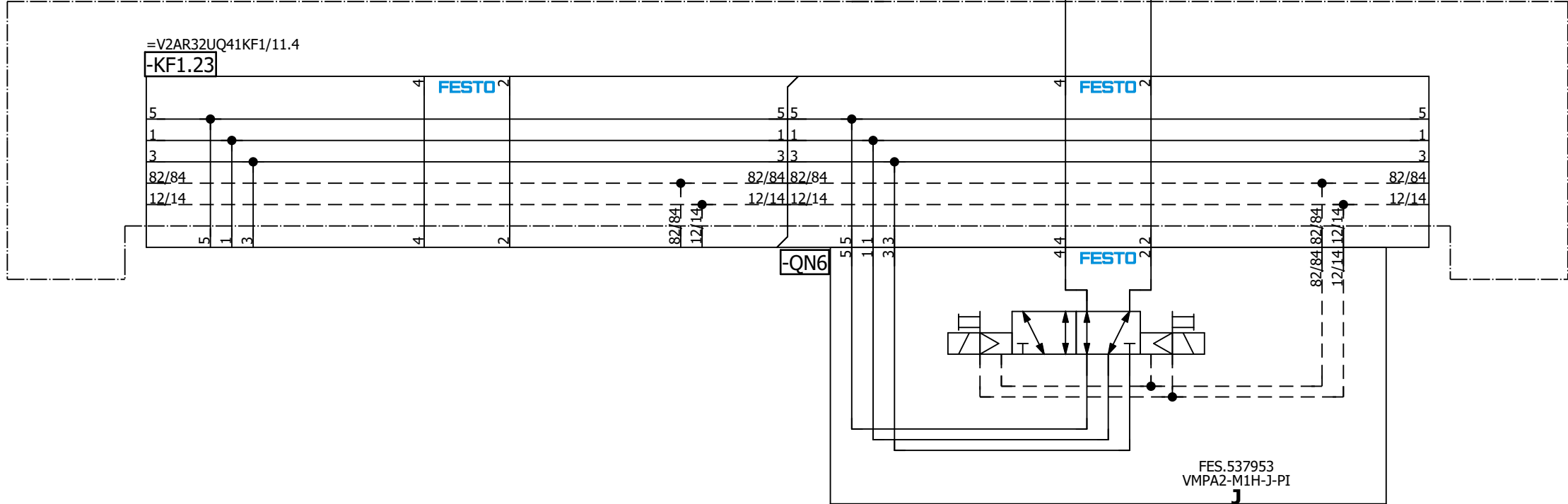

=V2AR32UQ41  
-UQ6-QN6.1  
L320 Model  
Shot Pin (RST)

=V2AR32UQ41  
-UQ6-QN6.2  
L320 Model  
Shot Pin (SET)

=V2AR32UQ41UQ5/1

			Date	1/17/2023
			Ed.	MKLEPADLO
			Appr.	
Modification	Date	Name	Original	

Volvo Trucks North America		
P6700 Framing - Cell 2V01, KF1		
Replacement of	Replaced by	

Valiant TMS	Scale 1:1
-------------	-----------

L320 Model Shot Pin
---------------------

Drawing name: =2V01&MFS-PNEU_KF1	
Document type: MFS	Project nr: 22-16152

= V2AR32UQ41UQ6 + V2AR32UQ41		Page 1
		275

=V2AR32UQ41UQ7/1





=V2AR32UQ41KF1

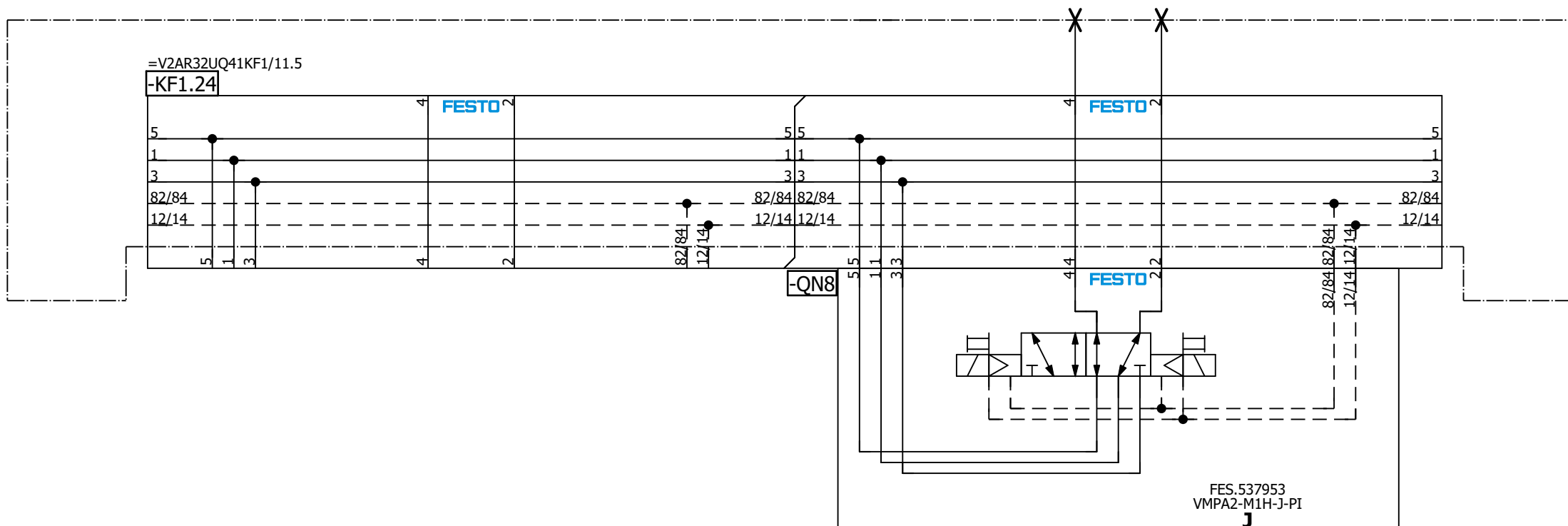

=V2AR32UQ41  
-UQ8-QN8.1  
Spare  
(RST)

=V2AR32UQ41  
-UQ8-QN8.2  
Spare  
(SET)

=V2AR32UQ42KF1+.AR32UQ42/1

=V2AR32UQ41UQ7/1

Date		12/20/2022		Volvo Trucks North America		Valiant TMS		Spare		Drawing name:		= V2AR32UQ41UQ8	
Ed.		MKLEPADLO		P6700 Framing - Cell 2V01, KF1		Scale 1:1				Document type:		= V2AR32UQ41	
Appr.				Replacement of		Replaced by				Project nr:		Page	
Original										22-16152		1	
Modification		Date		Name		Original				MFS		275	



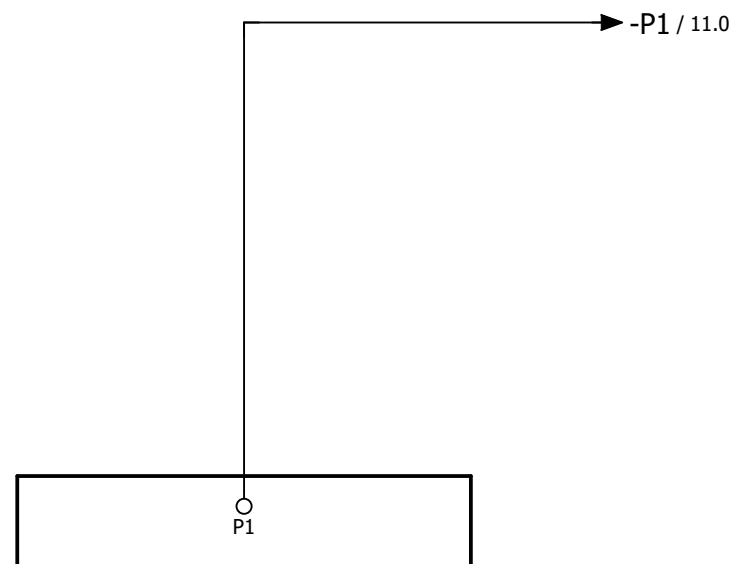

=V2AR32UQ41UQ8+.AR32UQ41/1

		Date	1/3/2023	Volvo Trucks North America			Valiant TMS	AIR SUPPLY GRIPPER	Drawing name:		= V2AR32UQ42KF1
		Ed.	MKLEPADLO	P6700 Framing - Cell 2V01, KF1					=2V01&MFS-PNEU_KF1		+ V2AR32UQ42
		Appr		Replacement of		Replaced by	Scale 1:1		Document type:	Project nr:	Page
Modification	Date	Name	Original						MFS	22-16152	1
											275

M1

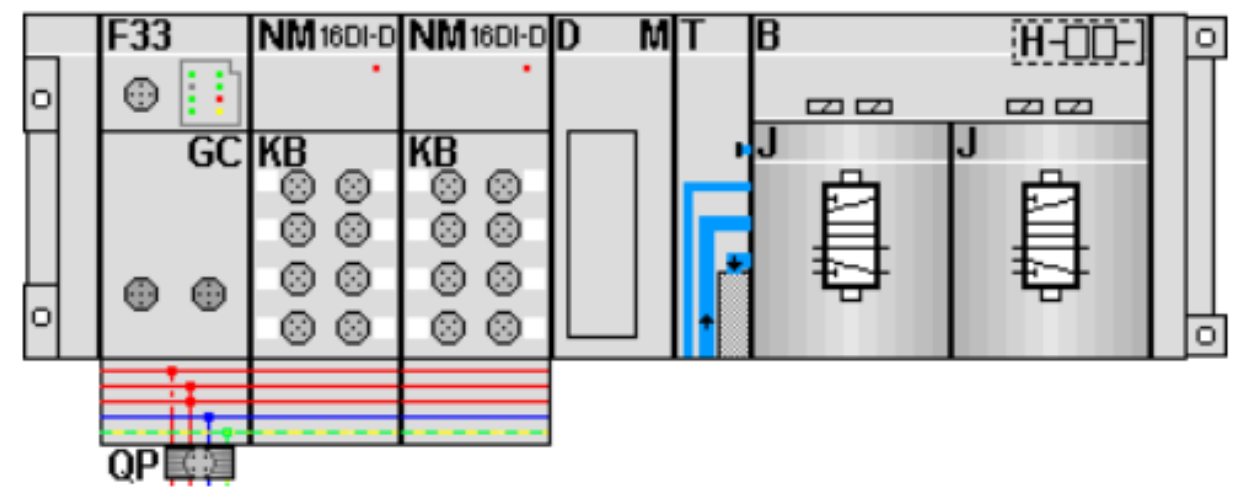

KF1.0

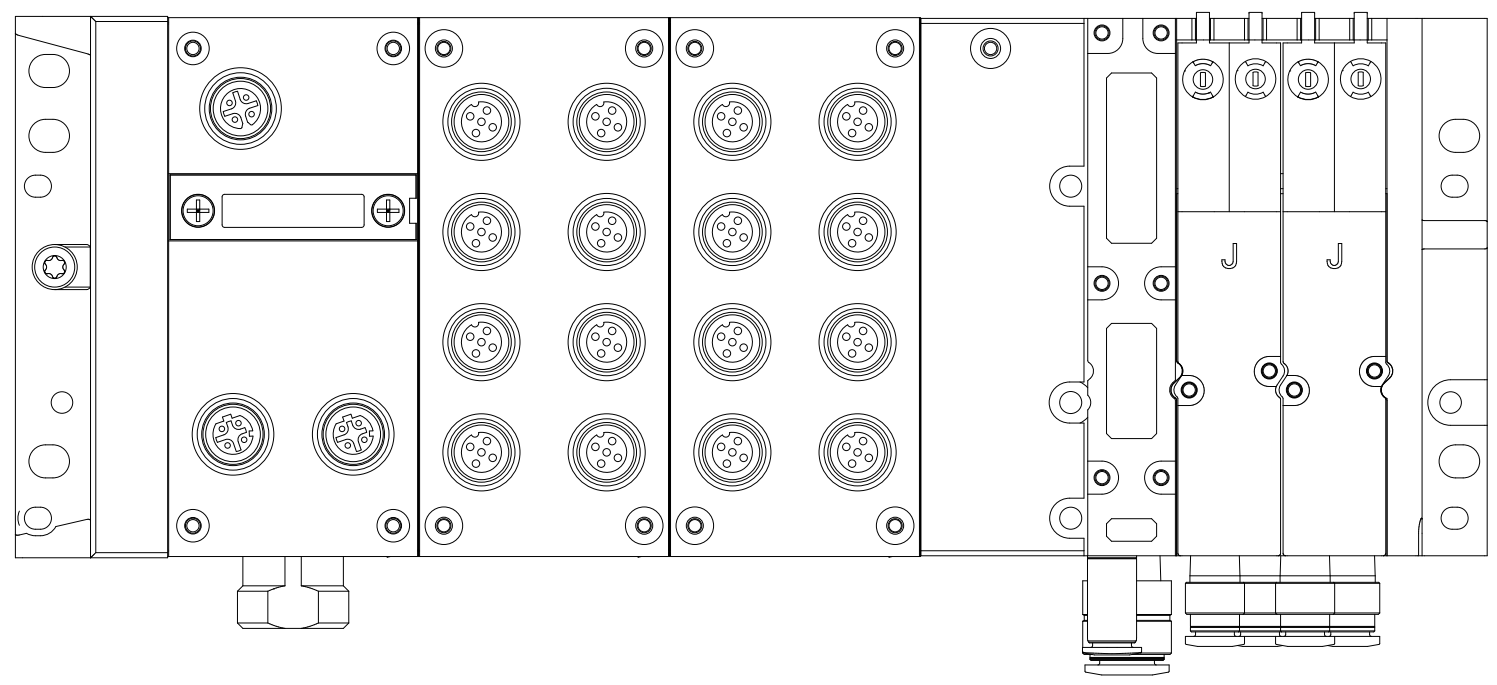

		Date	1/17/2023	Volvo Trucks North America			Valiant TMS	AIR SUPPLY	Drawing name:		= V2AR32UQ42KF1
		Ed.	MKLEPADLO	P6700 Framing - Cell 2V01, KF1			Scale 1:1		=2V01&MFS-PNEU_KF1		+ V2AR32UQ42
Modification	Date	Name	Original	Replacement of	Replaced by			Document type:	Project nr:	Page	5
								MFS	22-16152		275

M1

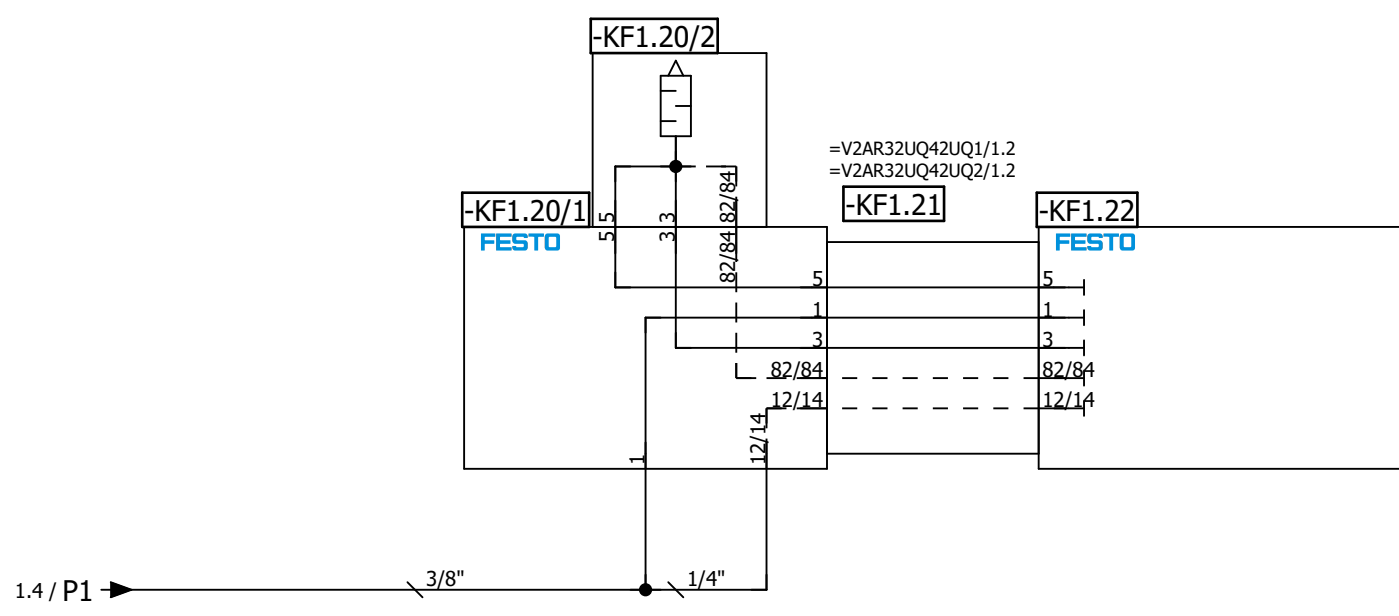
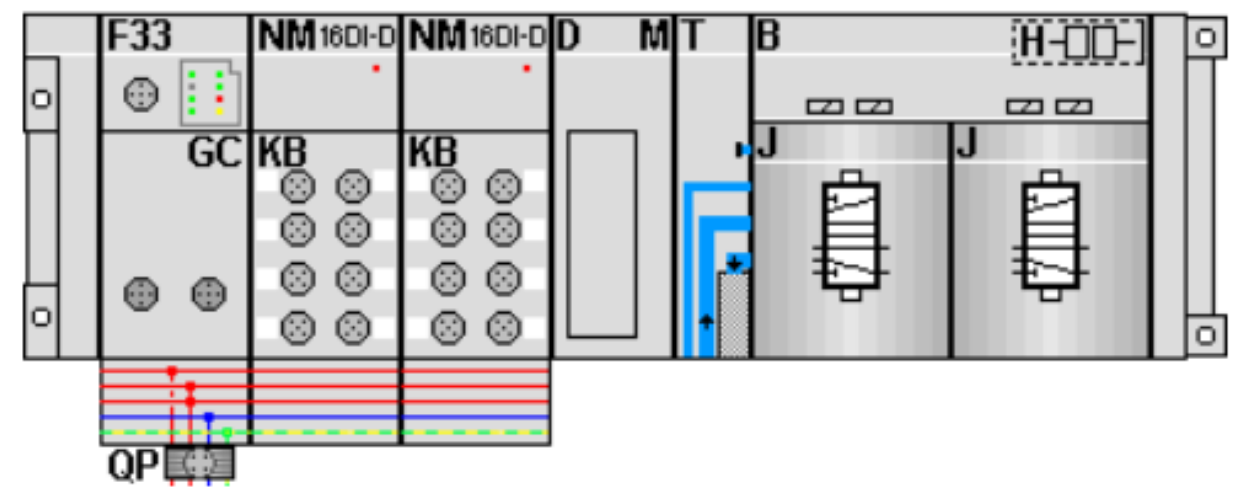

5

=V2AR32UQ42UQ1/1

Date		1/17/2023		Volvo Trucks North America		Valiant TMS		AIR SUPPLY		Drawing name:		= V2AR32UQ42KF1	
Ed.		MKLEPADLO		P6700 Framing - Cell 2V01, KF1		Scale 1:1				Document type:		= 2V01&MFS-PNEU_KF1	
Appr				Replacement of		Replaced by				Project nr:		22-16152	
Modification	Date	Name	Original							MFS		Page 11	
												275	

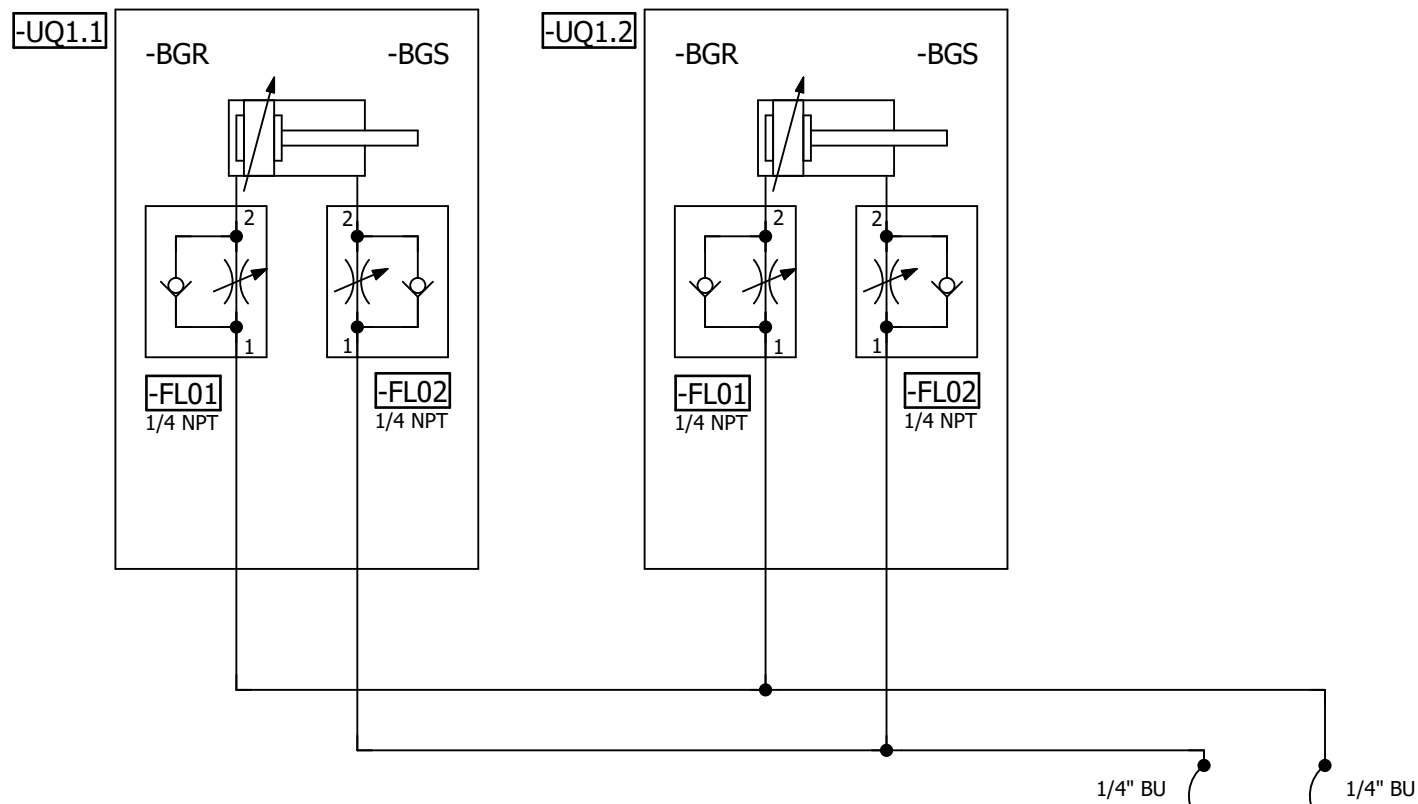

=V2AR32UQ42KF1

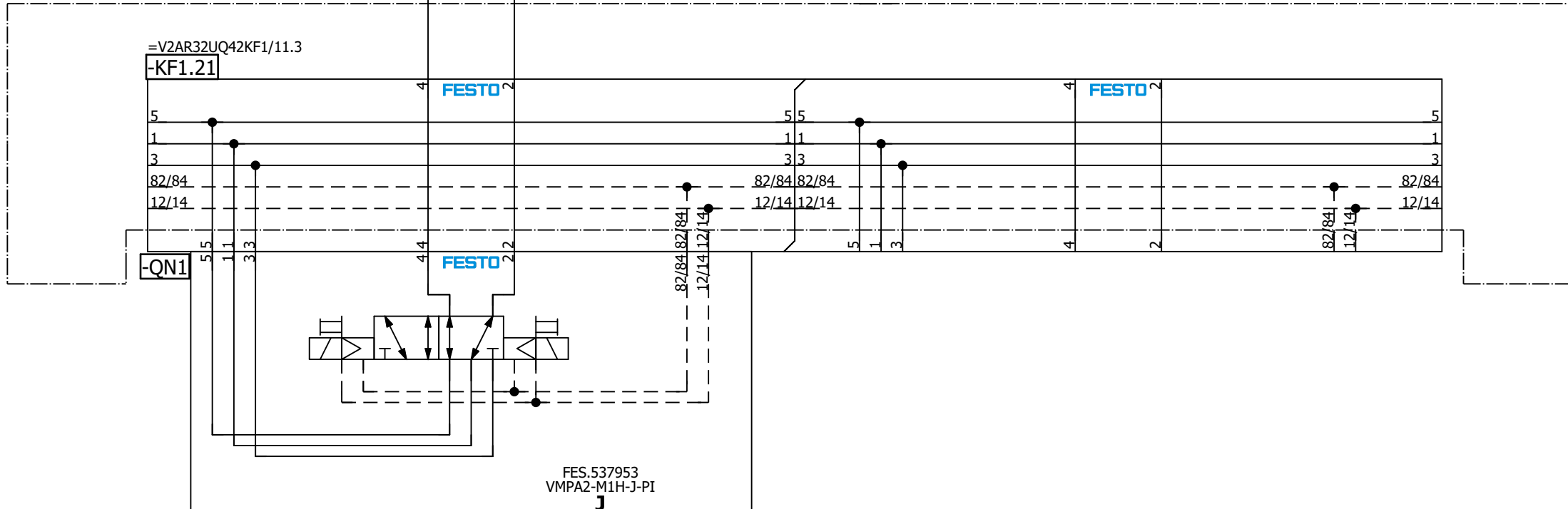

=V2AR32UQ42  
-UQ1-QN1.1  
Common  
Clamps (RST)

=V2AR32UQ42  
-UQ1-QN1.2  
Common  
Clamps (SET)

=V2AR32UQ42KF1/11

=V2AR32UQ42UQ2/1

Date: 1/17/2023		Volvo Trucks North America		Valiant TMS		Drawing name: =2V01&MFS-PNEU_KF1		= V2AR32UQ42UQ1	
Ed.: MKLEPADLO		P6700 Framing - Cell 2V01, KF1		Common Clamps		Document type: MFS		+ V2AR32UQ42	
Appr:		Replacement of		Scale 1:1		Project nr: 22-16152		Page 1	
Original		Replaced by						275	

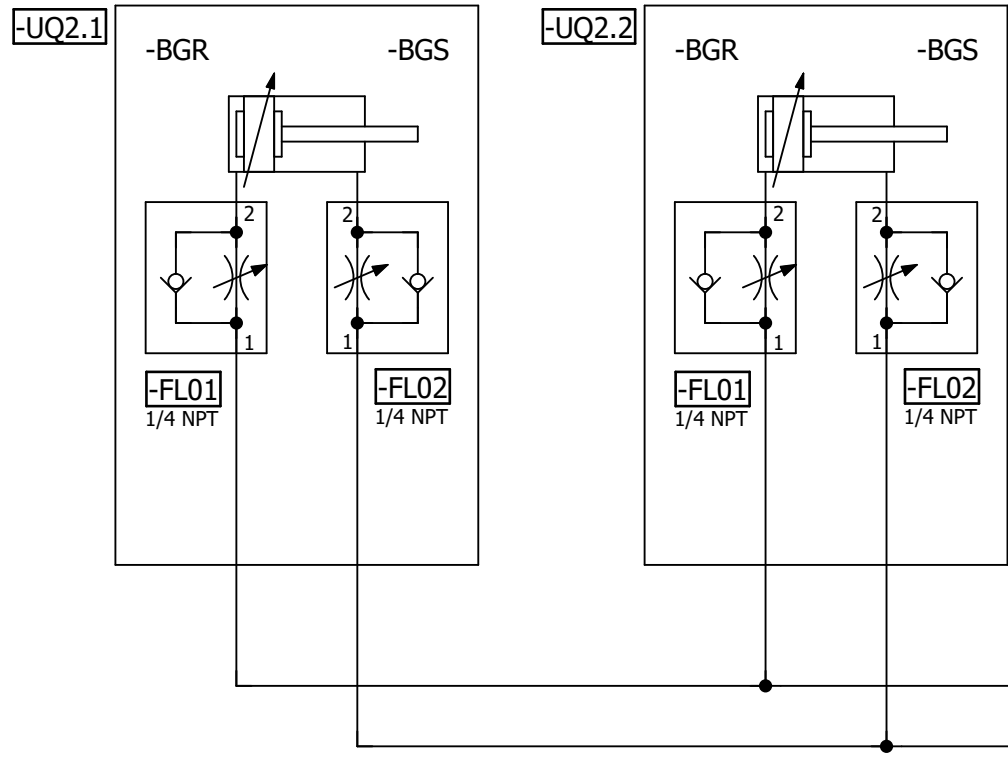

=V2AR32UQ42KF1

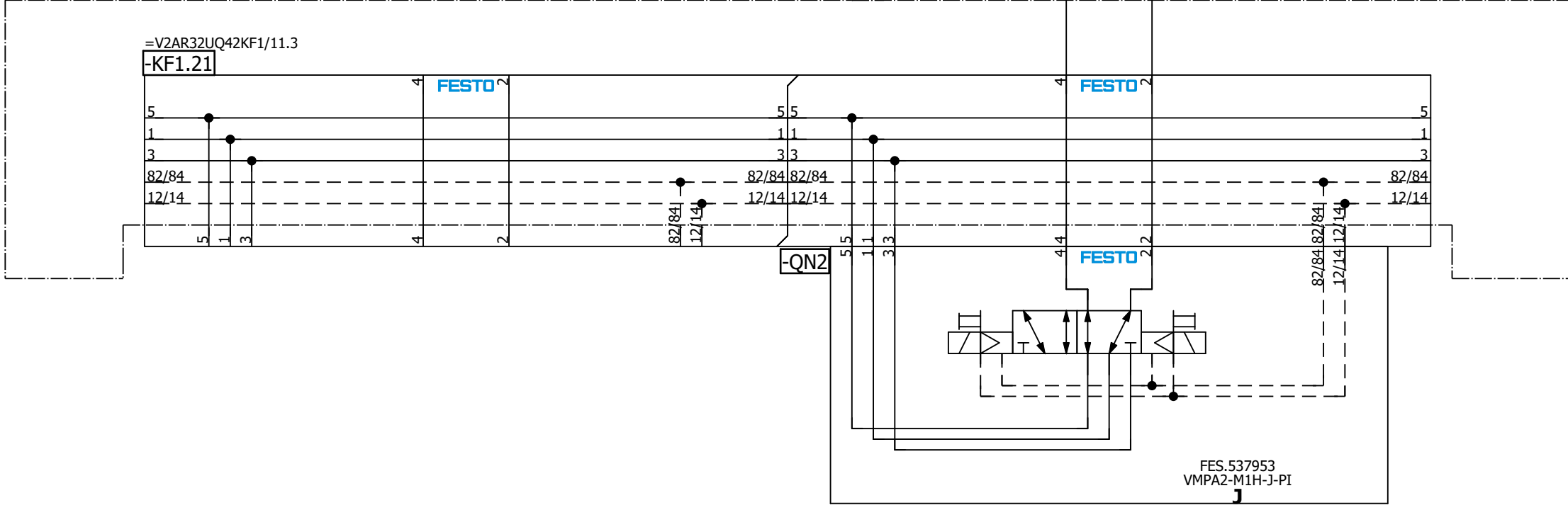

=V2AR32UQ42  
-UQ2-QN2.1  
L150 Model  
Clamps (RST)

=V2AR32UQ42  
-UQ2-QN2.2  
L150 Model  
Clamps (SET)

=V2AR32XQ41KF1+.AR32KF1/5



M1

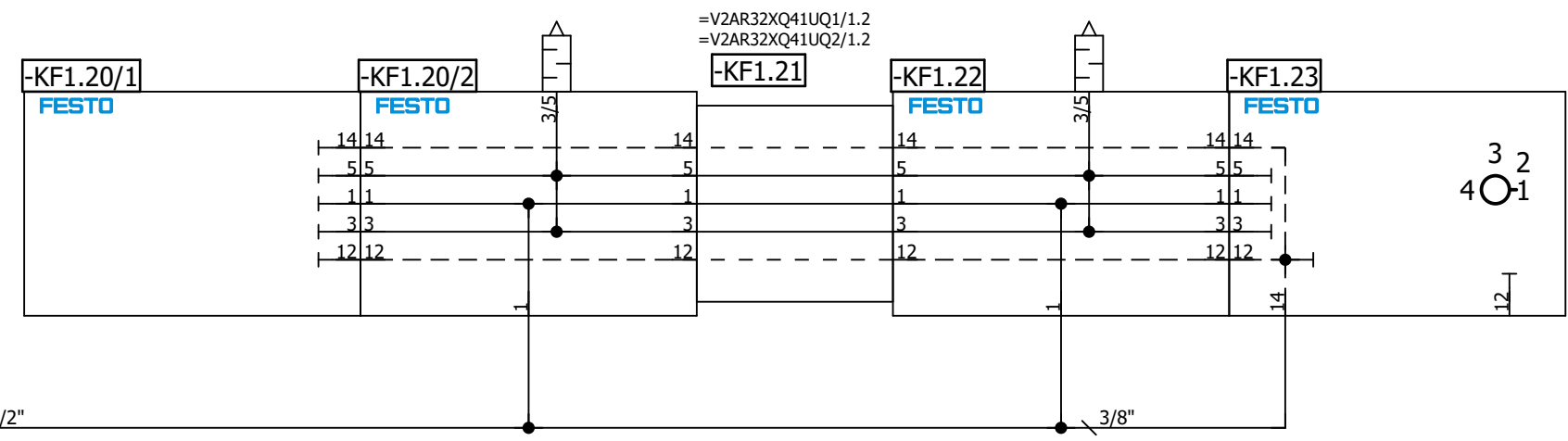
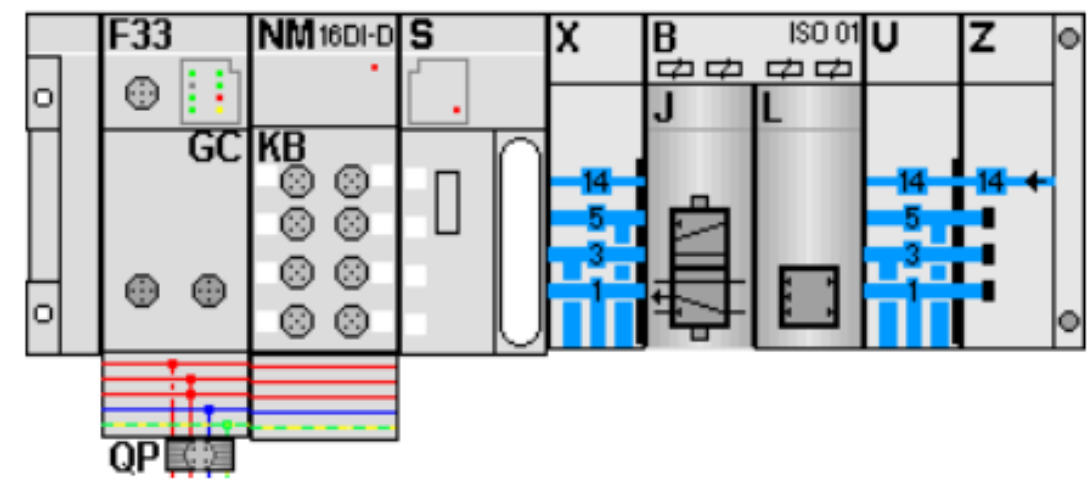

=KH0+KH0/1.0 / +KH0-V2AR32XQ41

5

=V2AR32XQ41UQ1/1

Date	1/17/2023	Volvo Trucks North America	Valiant TMS	AIR SUPPLY	Drawing name:	= V2AR32XQ41KF1
Ed.	MKLEPADLO	P6700 Framing - Cell 2V01, KF1			Document type:	MFS
Appr		Replacement of	Replaced by	Scale 1:1		Page 11
Modification	Date	Name	Original			275





=V2AR32XQ41KF1

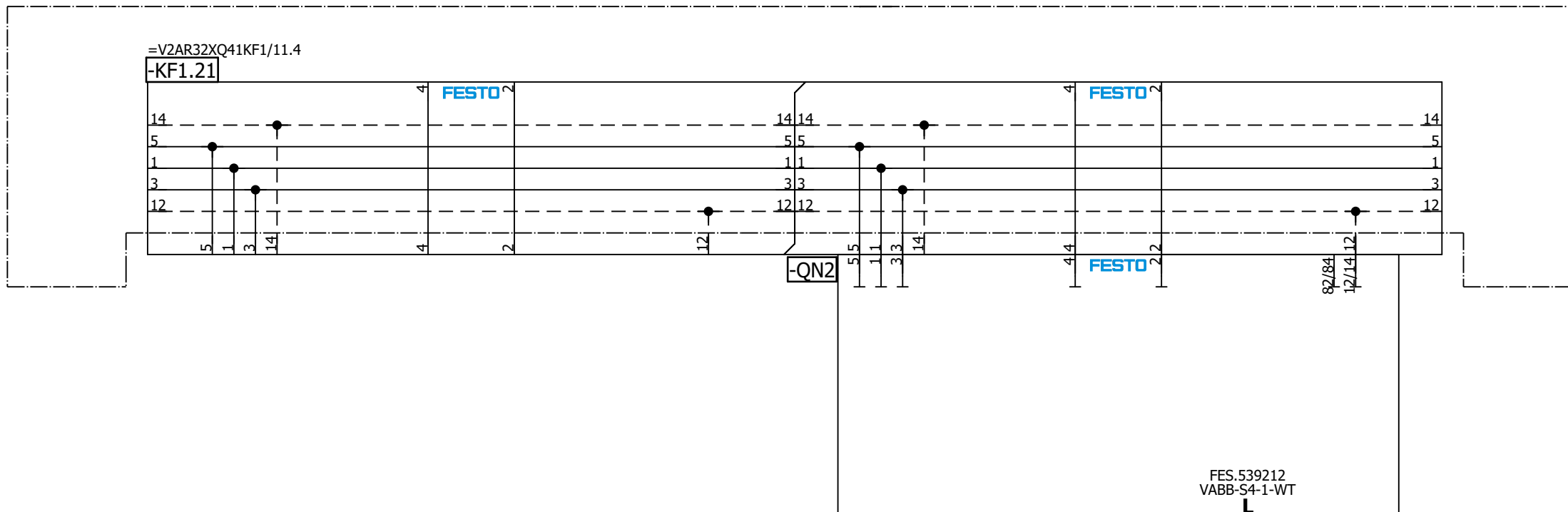

=V2AR32XQ41UQ1/1

=V2AR41UQ41KF1+.AR41UQ41/1

		Date	12/20/2022	Volvo Trucks North America		Valiant TMS	Spare	Drawing name:		= V2AR32XQ41UQ2
		Ed.	MKLEPADLO	P6700 Framing - Cell 2V01, KF1		Scale 1:1			=2V01&MFS-PNEU_KF1	
Modification	Date	Name	Original	Replacement of	Replaced by			Document type:	Project nr:	Page
								MFS	22-16152	1
										275

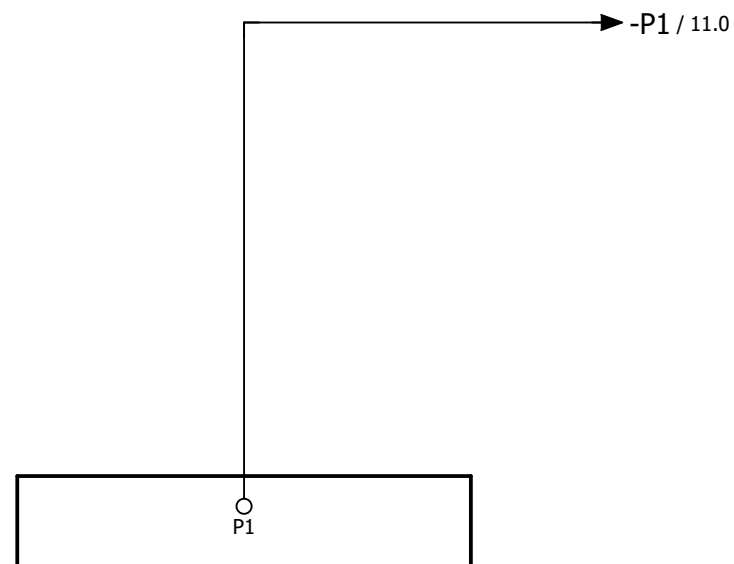

=V2AR32XQ41UQ2+.AR32KF1/1

		Date	1/3/2023	Volvo Trucks North America			Valiant TMS	AIR SUPPLY GRIPPER	Drawing name:		= V2AR41UQ41KF1
		Ed.	MKLEPADLO	P6700 Framing - Cell 2V01, KF1					=2V01&MFS-PNEU_KF1		+ V2AR41UQ41
Modification	Date	Name	Original	Replacement of	Replaced by		Scale 1:1		Document type:	Project nr:	Page
									MFS	22-16152	1
											275

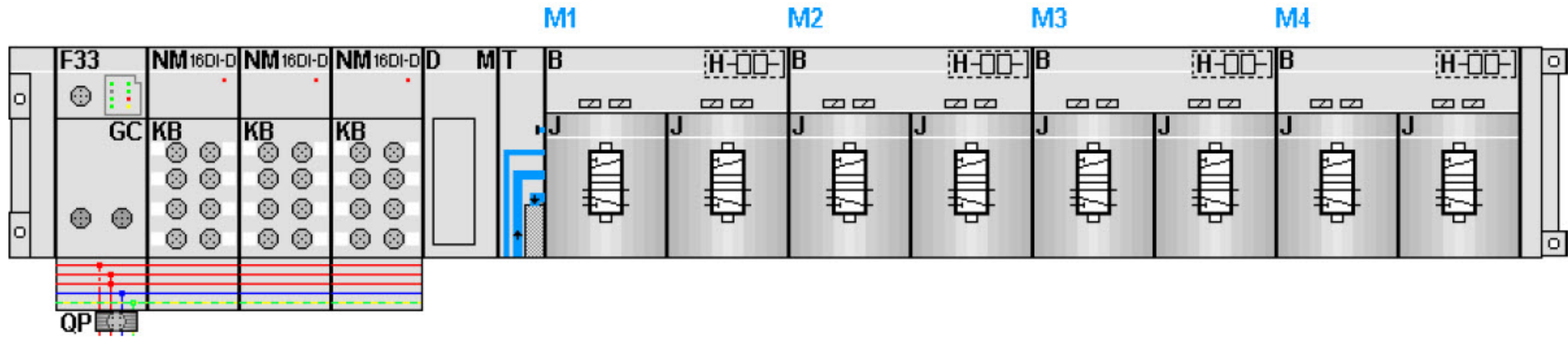

KF1.0

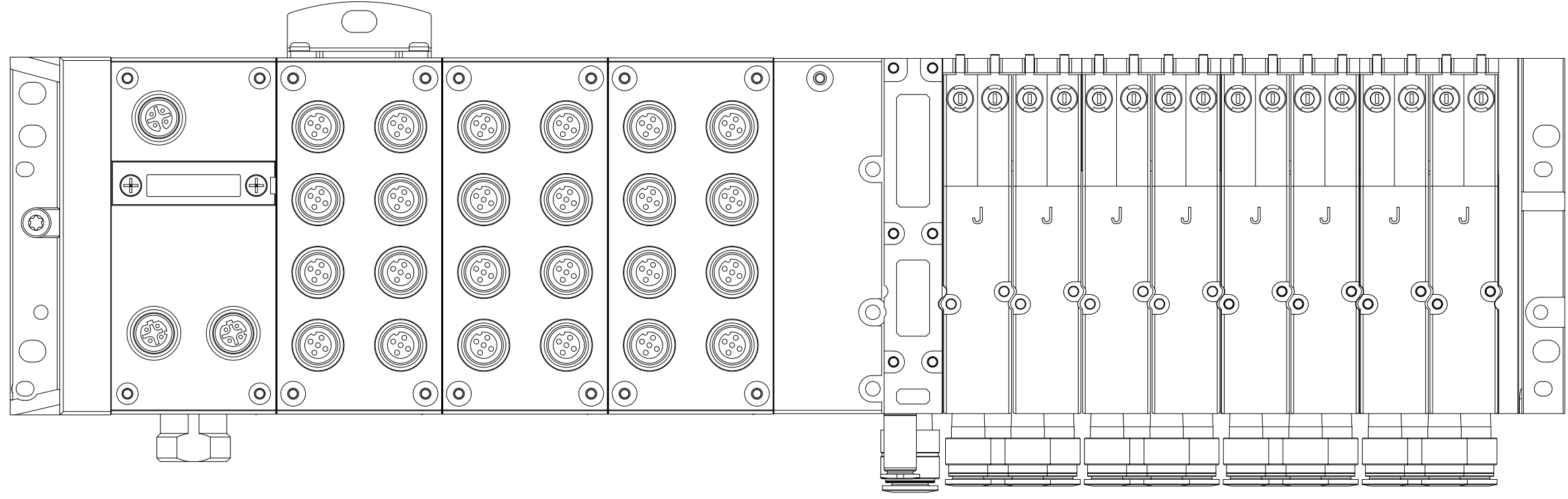

Date		1/17/2023	Volvo Trucks North America		Valiant TMS	AIR SUPPLY	Drawing name:		= V2AR41UQ41KF1			
Ed.		MKLEPADLO	P6700 Framing - Cell 2V01, KF1				=2V01&MFS-PNEU_KF1		+ V2AR41UQ41			
Appr			Replacement of		Scale 1:1	Document type:		MFS	Project nr:	22-16152	Page	5
Original			Replaced by			MFS		22-16152		275		



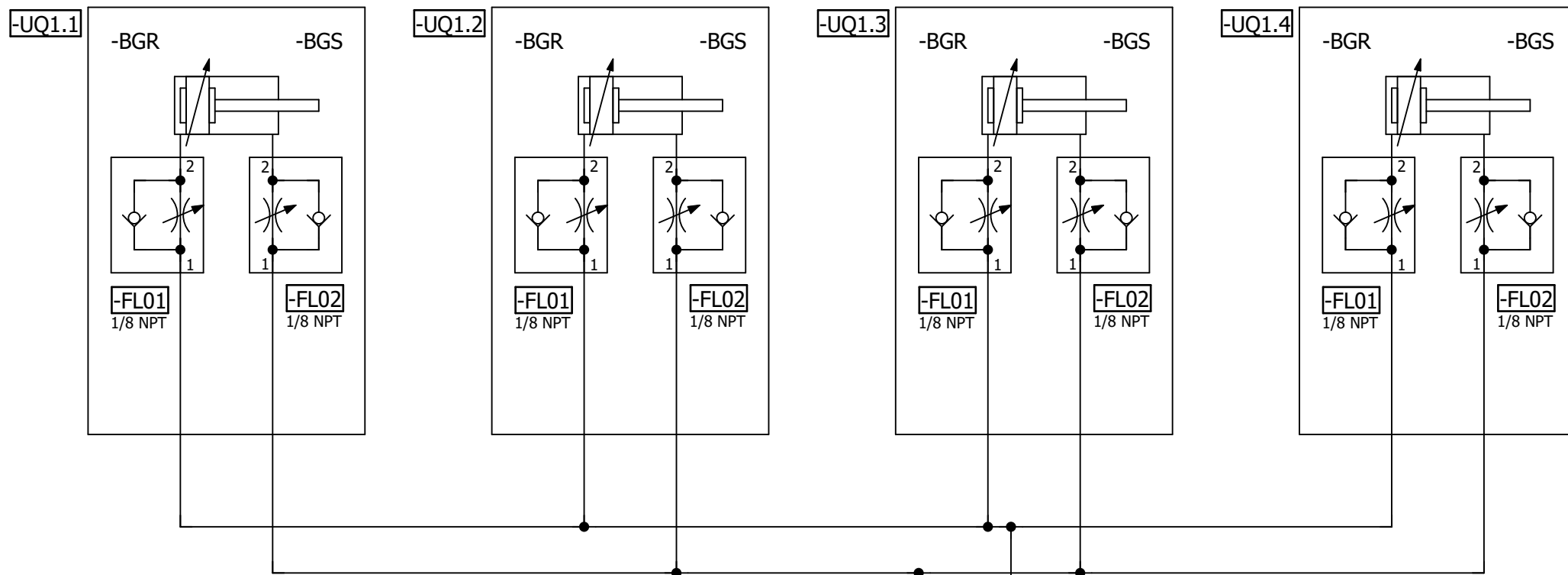

=V2AR41UQ41KF1

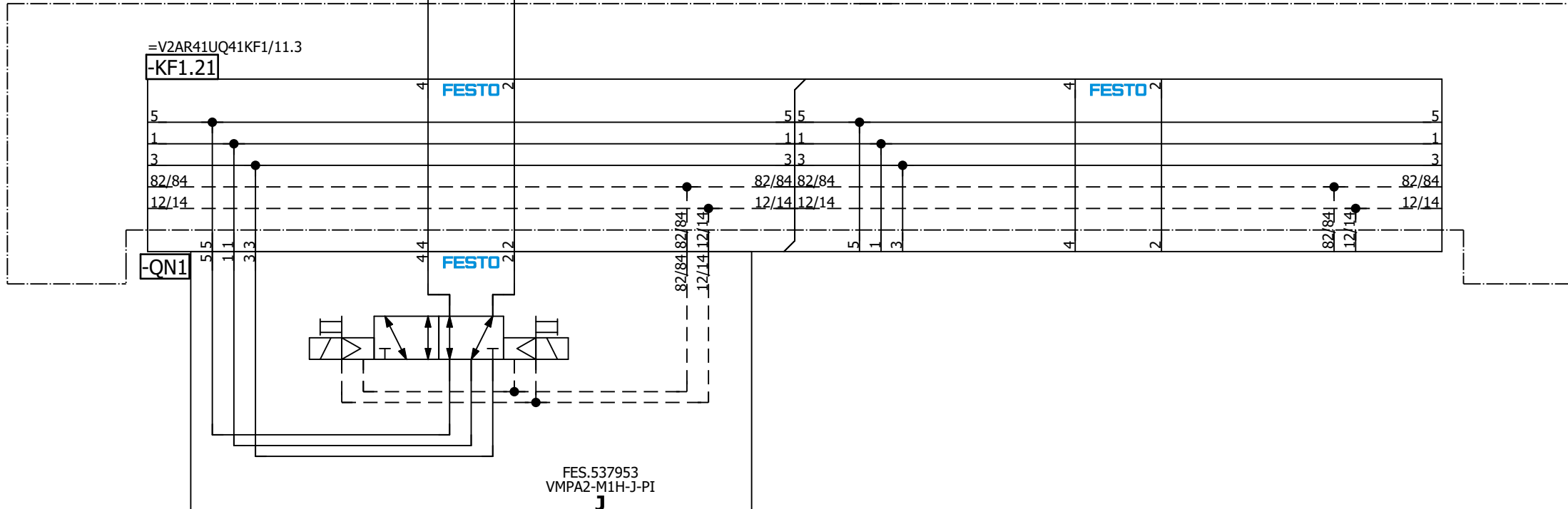

=V2AR41UQ41  
-UQ1-QN1.1  
L150 Model  
Shot Pins (RST)

=V2AR41UQ41  
-UQ1-QN1.2  
L150 Model  
Shot Pins (SET)

=V2AR41UQ41KF1/11

=V2AR41UQ41UQ2/1

Date		1/17/2023	Volvo Trucks North America		Valiant TMS		L150 Model Shot Pins		Drawing name:		= V2AR41UQ41UQ1	
Ed.		MKLEPADLO	P6700 Framing - Cell 2V01, KF1		Scale 1:1				=2V01&MFS-PNEU_KF1		+ V2AR41UQ41	
Appr			Replacement of		Replaced by				Document type:		Project nr:	
Original									MFS		22-16152	
Modification		Date	Name		Original						Page	
											1	
											275	

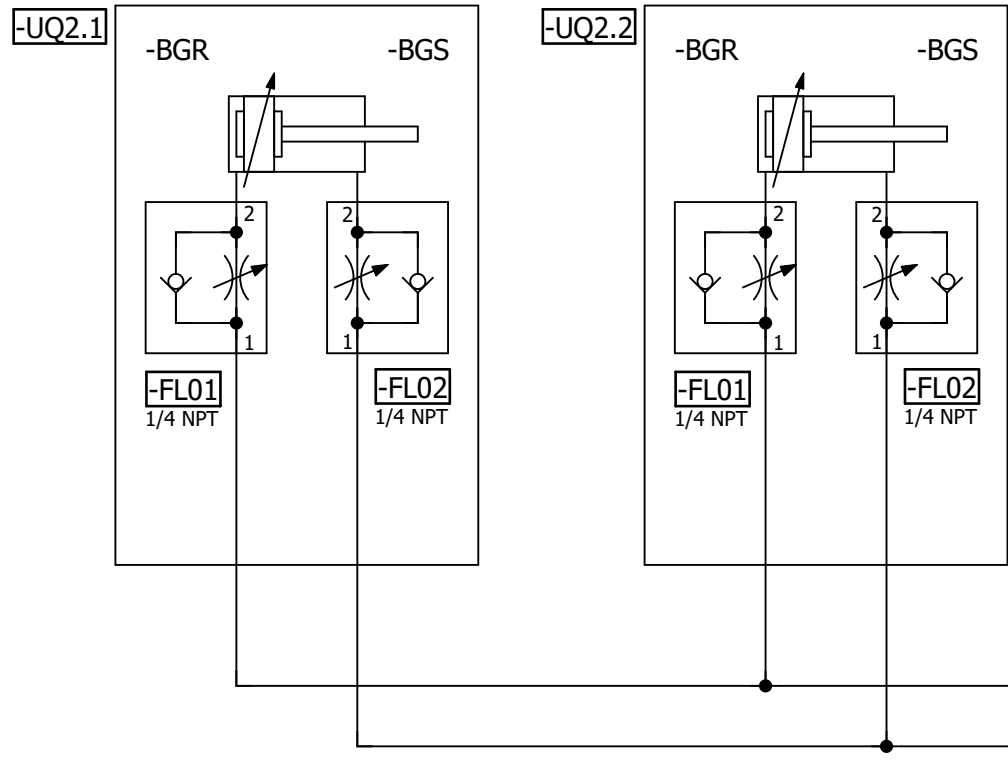

=V2AR41UQ41KF1

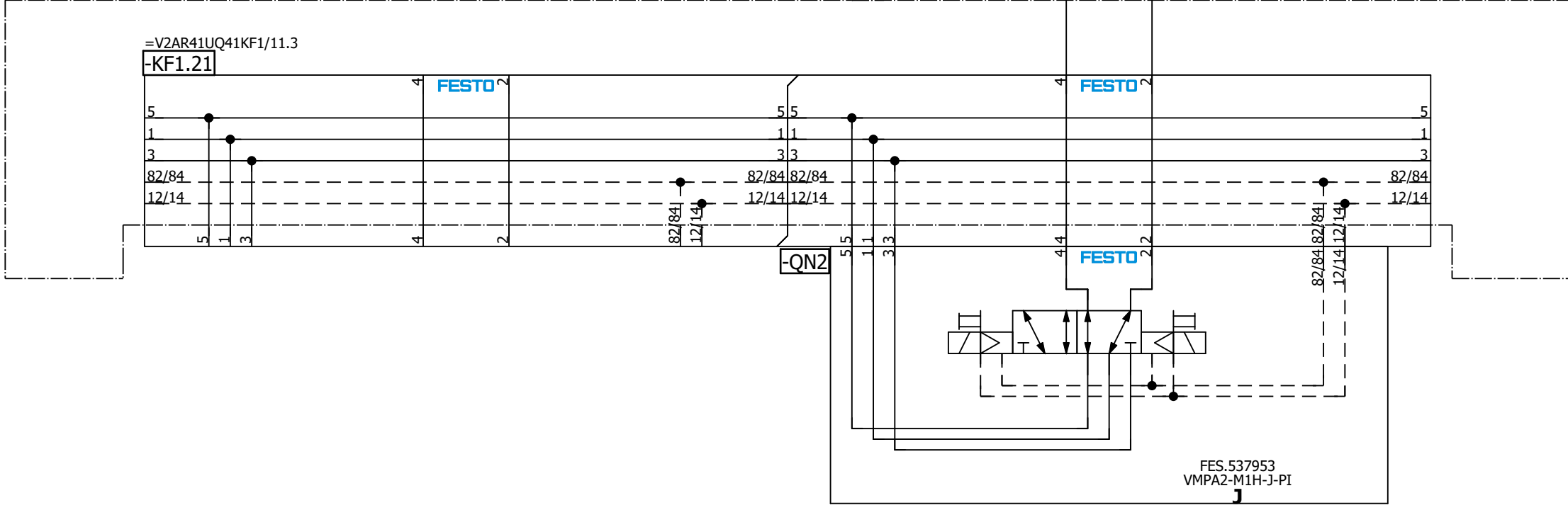

=V2AR41UQ41  
-UQ2-QN2.1  
L150 Model  
Clamps 1 (RST)

=V2AR41UQ41  
-UQ2-QN2.2  
L150 Model  
Clamps 1 (SET)

=V2AR41UQ41UQ1/1

=V2AR41UQ41UQ3/1

			Date	1/17/2023	Volvo Trucks North America		Valiant TMS	L150 Model Clamps 1	Drawing name:	= V2AR41UQ41UQ2
			Ed.	MKLEPADLO	P6700 Framing - Cell 2V01, KF1				=2V01&MFS-PNEU_KF1	+ V2AR41UQ41
Modification	Date	Name	Appr.	Original	Replacement of	Replaced by	Scale 1:1		Document type:	Project nr:
									MFS	22-16152
										Page 1
										275

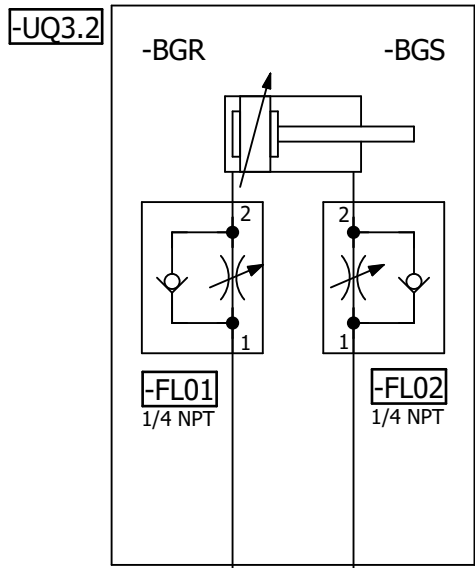
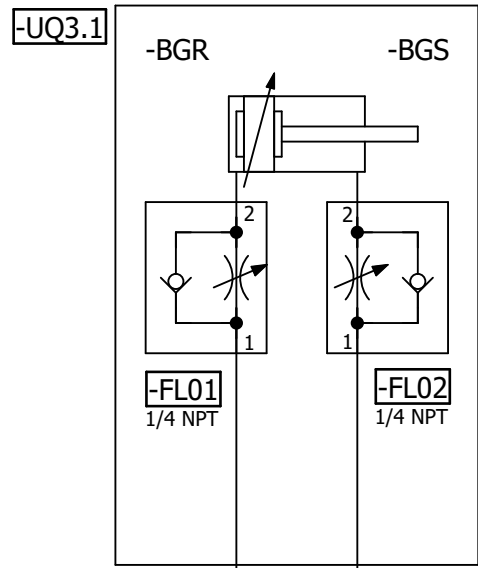

=V2AR41UQ41KF1

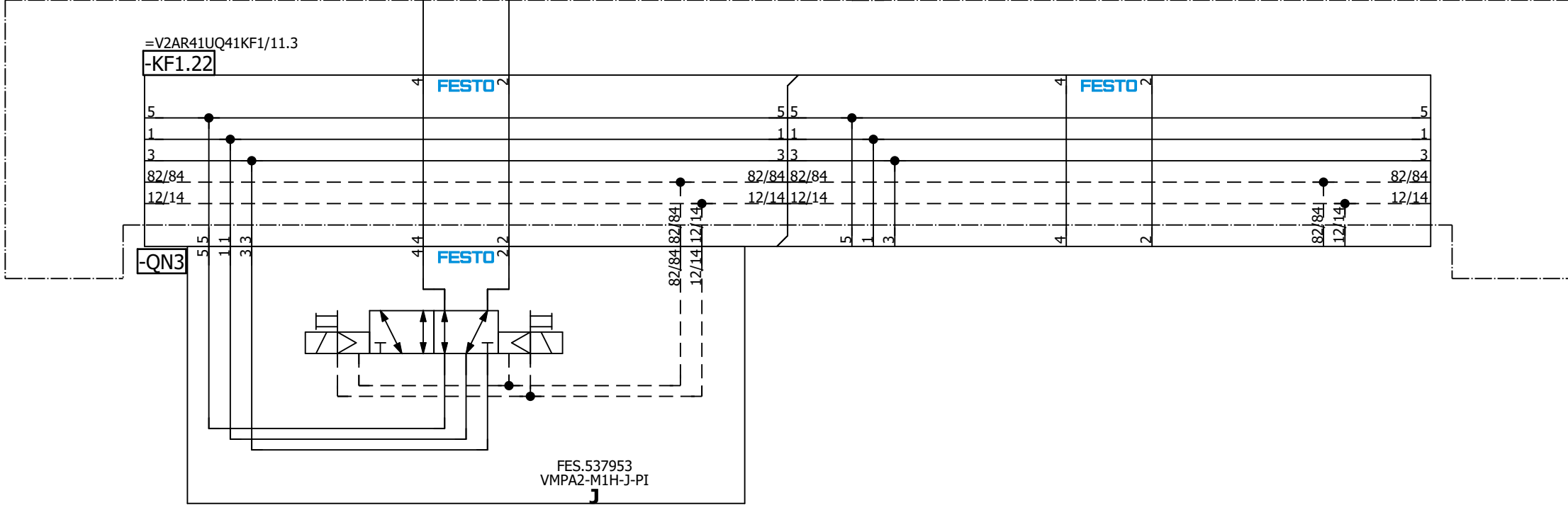

=V2AR41UQ41  
-UQ3-QN3.1  
Common  
Clamps (RST)

=V2AR41UQ41  
-UQ3-QN3.2  
Common  
Clamps (SET)

=V2AR41UQ41UQ2/1

=V2AR41UQ41UQ4/1

Date		1/17/2023	Volvo Trucks North America		Valiant TMS	Common Clamps	Drawing name:		= V2AR41UQ41UQ3
Ed.		MKLEPADLO	P6700 Framing - Cell 2V01, KF1				=2V01&MFS-PNEU_KF1		+ V2AR41UQ41
Appr.			Replacement of		Scale 1:1		Document type:		Project nr:
Original			Replaced by				MFS	22-16152	
									1
									275



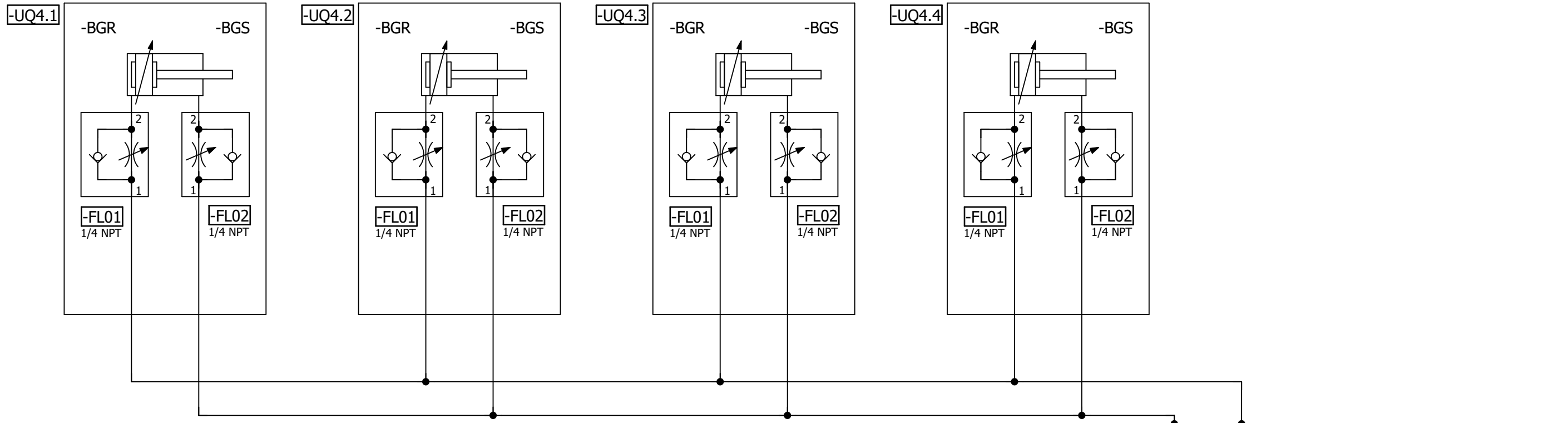

=V2AR41UQ41KF1

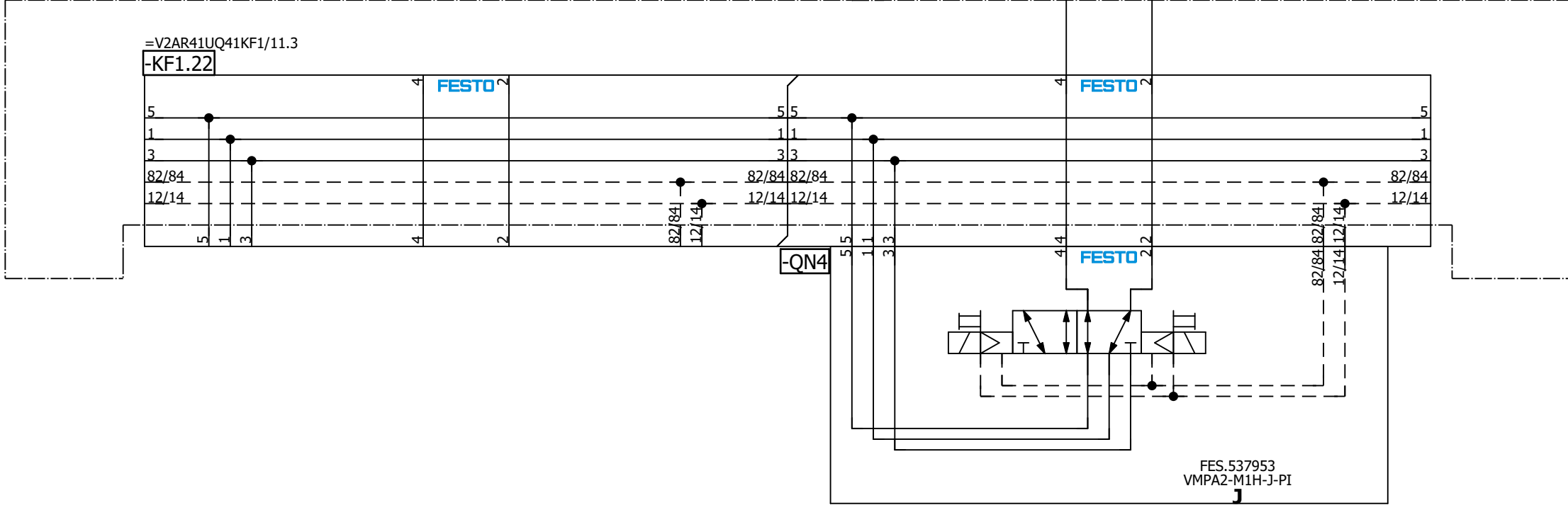

=V2AR41UQ41  
-UQ4-QN4.1  
L230/290/320  
Clamps 1 (RST)

=V2AR41UQ41  
-UQ4-QN4.2  
L230/290/320  
Clamps 1 (SET)

=V2AR41UQ41UQ3/1

=V2AR41UQ41UQ5/1

Date		1/17/2023		Volvo Trucks North America		Valiant TMS		L230/290/320 Model Clamps 1		Drawing name:		= V2AR41UQ41UQ4	
Ed.		MKLEPADLO		P6700 Framing - Cell 2V01, KF1		Scale 1:1				Document type:		= V2AR41UQ41	
Appr.				Replacement of		Replaced by				Project nr:		Page	
Original										22-16152		1	
Modification		Date		Name		Original				MFS		275	

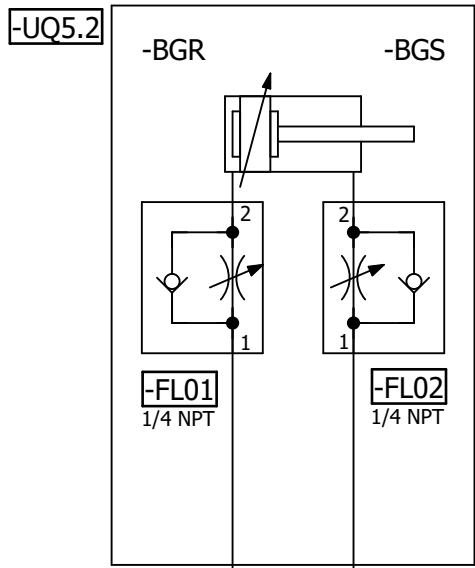
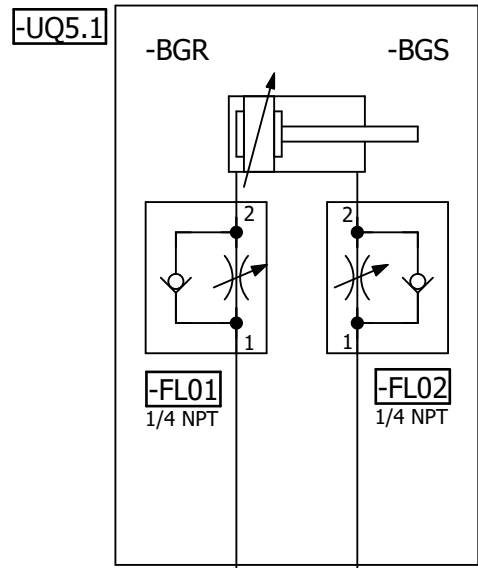

=V2AR41UQ41KF1

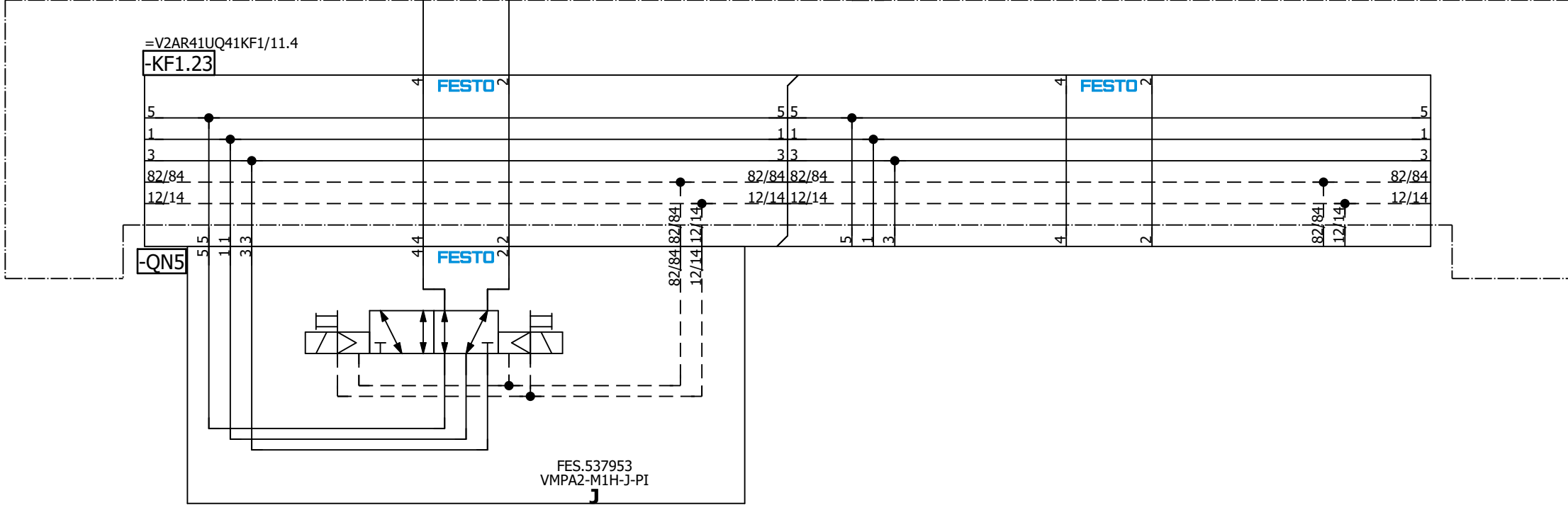

=V2AR41UQ41  
-UQ5-QN5.1  
L230/290/320  
Clamps 2 (RST)

=V2AR41UQ41  
-UQ5-QN5.2  
L230/290/320  
Clamps 2 (SET)

=V2AR41UQ41UQ4/1

=V2AR41UQ41UQ6/1

			Date	1/17/2023	Volvo Trucks North America		Valiant TMS	L230/290/320 Model Clamps 2	Drawing name:	= V2AR41UQ41UQ5	
			Ed.	MKLEPADLO	P6700 Framing - Cell 2V01, KF1				=2V01&MFS-PNEU_KF1	+ V2AR41UQ41	
Modification	Date	Name	Appr	Original	Replacement of	Replaced by	Scale 1:1		Document type:	Project nr:	Page
									MFS	22-16152	1
											275





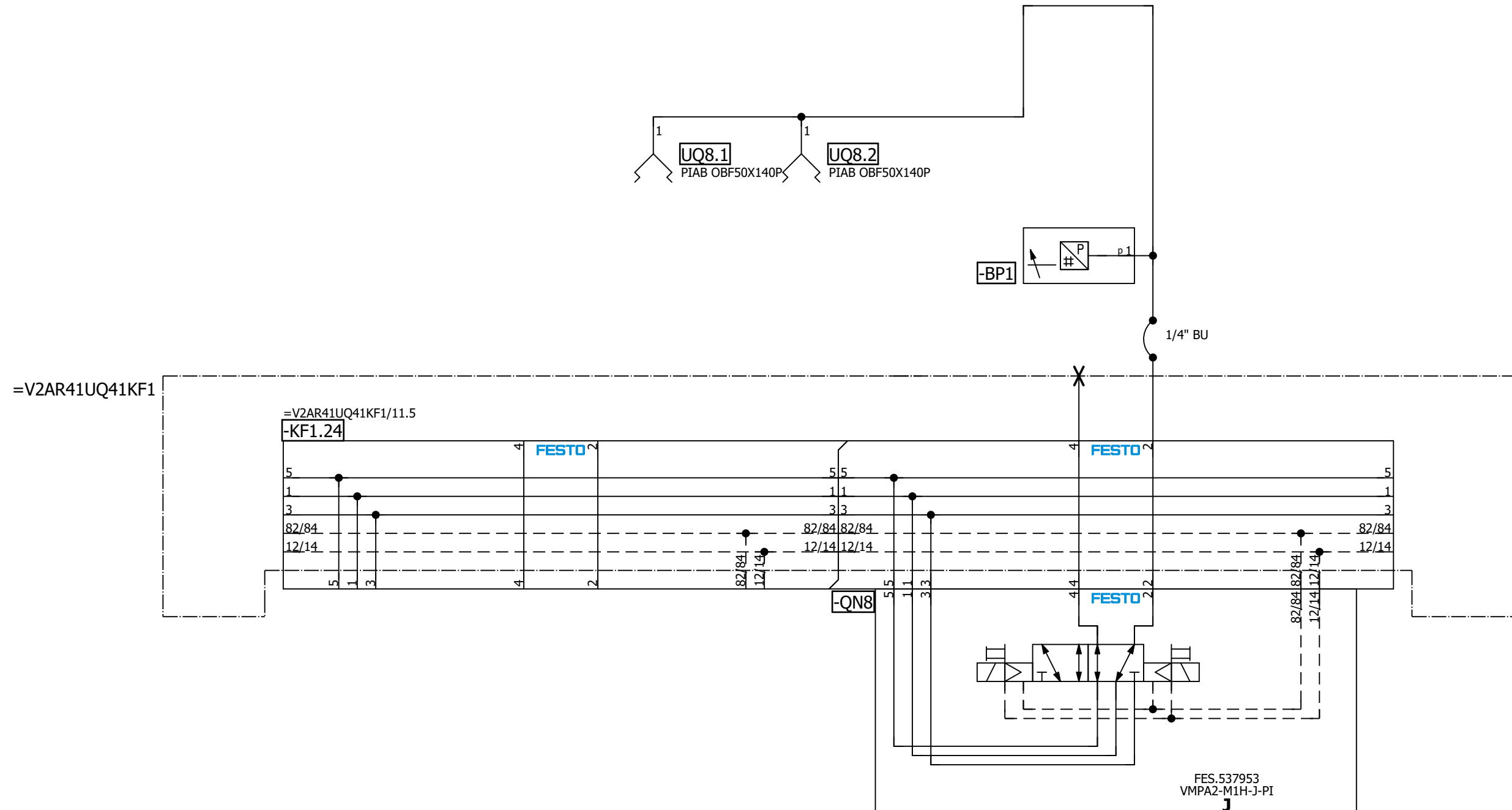

=V2AR41UQ41  
-UQ8-QN8.1  
Common  
Vacuums 2 (RST)

=V2AR41UQ41  
-UQ8-QN8.2  
Common  
Vacuums 2 (SET)

=V2AR41UQ41UQ7/1

=V2AR42UQ41KF1+.AR42UQ41/1

Date		12/20/2022		Volvo Trucks North America		Valiant TMS		Common Vacuums 2		Drawing name:		= V2AR41UQ41UQ8	
Ed.		MKLEPADLO		P6700 Framing - Cell 2V01, KF1		Scale 1:1				Document type:		= V2AR41UQ41	
Appr.				Replacement of		Replaced by				Project nr:		Page	
Original										22-16152		1	
Modification		Date		Name		Original				MFS		275	

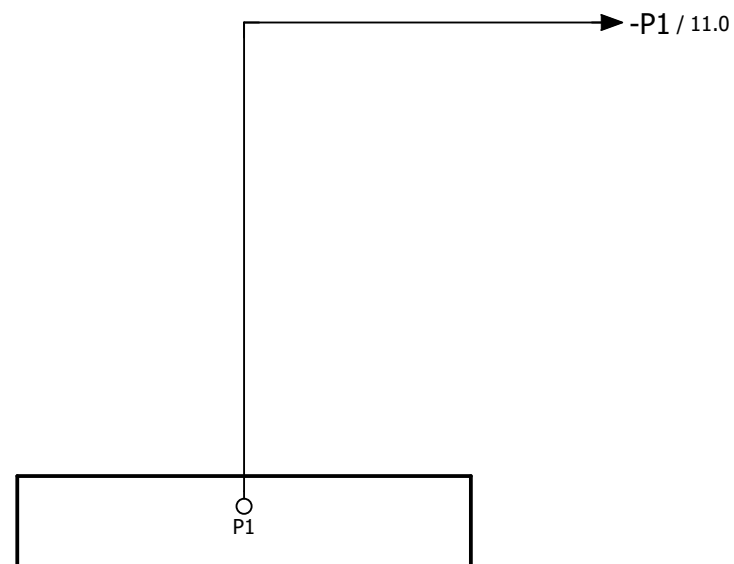

=V2AR41UQ41UQ8+.AR41UQ41/1

		Date	1/3/2023	Volvo Trucks North America			Valiant TMS	AIR SUPPLY GRIPPER	Drawing name:		= V2AR42UQ41KF1
		Ed.	MKLEPADLO	P6700 Framing - Cell 2V01, KF1					=2V01&MFS-PNEU_KF1		+ V2AR42UQ41
		Appr		Replacement of		Replaced by	Scale 1:1		Document type:	Project nr:	Page
Modification	Date	Name	Original						MFS	22-16152	1
											275

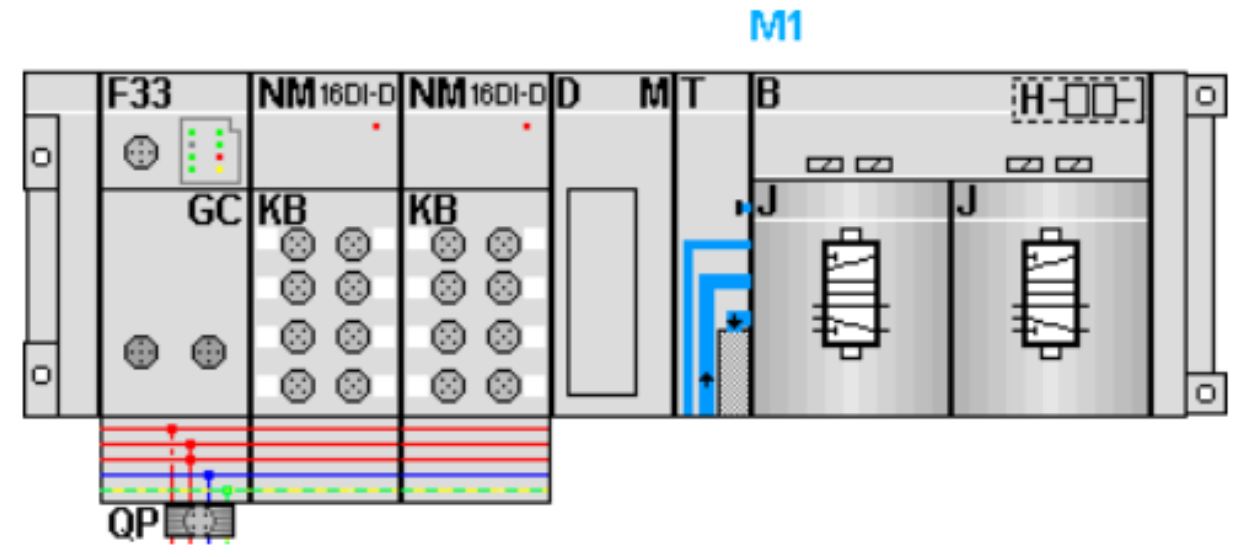

KF1.0

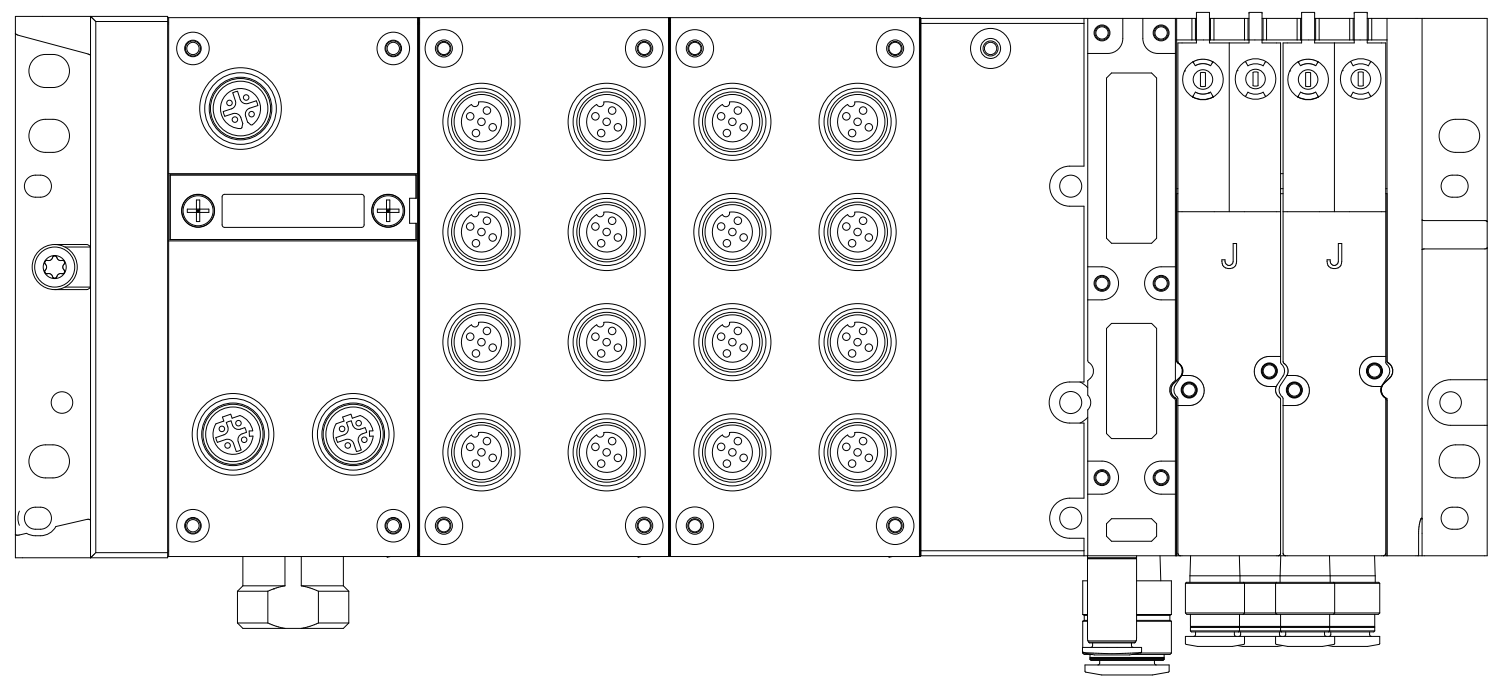

		Date	1/17/2023	Volvo Trucks North America			Valiant TMS	AIR SUPPLY	Drawing name:		= V2AR42UQ41KF1
		Ed.	MKLEPADLO	P6700 Framing - Cell 2V01, KF1			Scale 1:1		=2V01&MFS-PNEU_KF1		+ V2AR42UQ41
Modification	Date	Name	Original	Replacement of	Replaced by			Document type:	Project nr:	Page	5
								MFS	22-16152		275







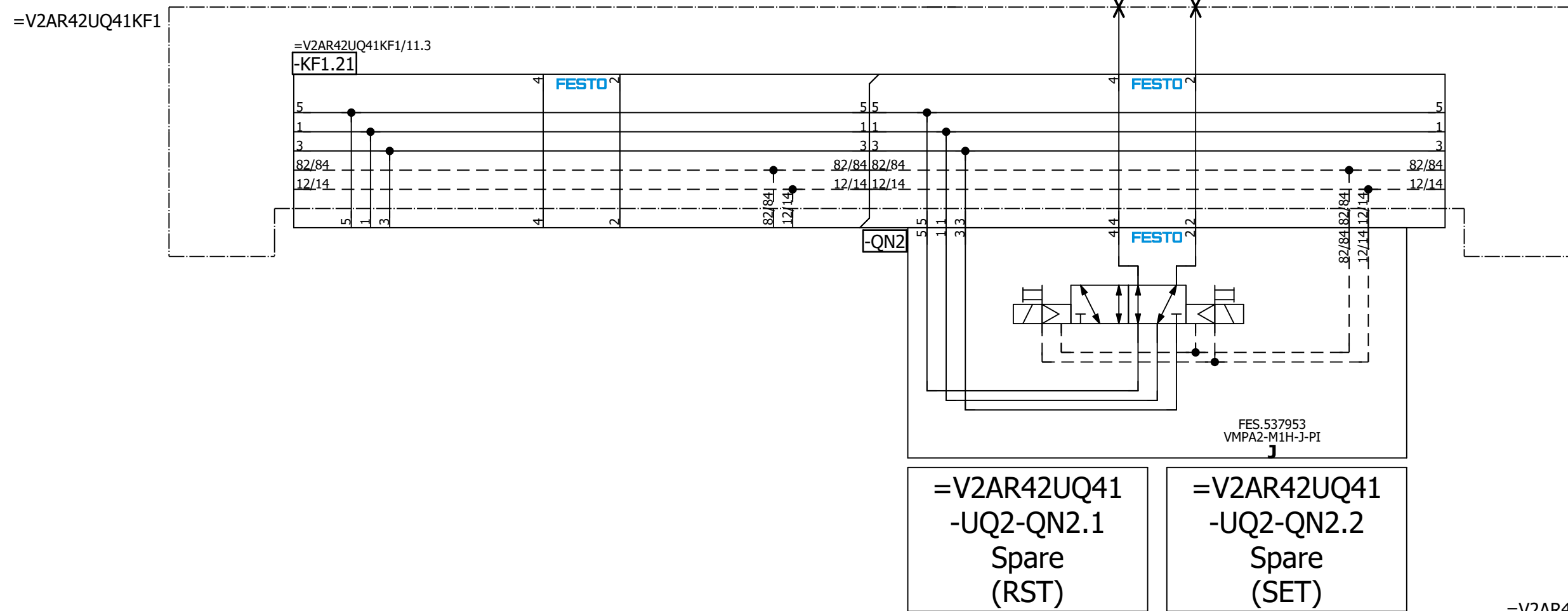



=V2AR42UQ41UQ1/1

=V2AR42UQ42KF1+.AR42UQ42/1

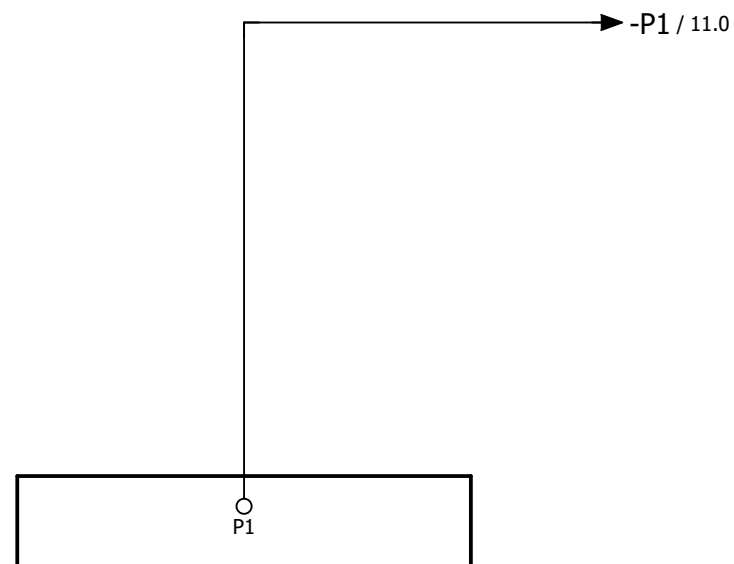
Date		12/20/2022		Volvo Trucks North America		Valiant TMS		Spare		Drawing name:		= V2AR42UQ41UQ2	
Ed.		MKLEPADLO		P6700 Framing - Cell 2V01, KF1		Scale 1:1				Document type:		+ V2AR42UQ41	
Appr.				Replacement of		Replaced by				Project nr:		Page	
Original										22-16152		1	
Modification		Date		Name		Original				MFS		275	



=V2AR42UQ41UQ2+.AR42UQ41/1

		Date	1/3/2023	Volvo Trucks North America			Valiant TMS	AIR SUPPLY GRIPPER	Drawing name:		= V2AR42UQ42KF1
		Ed.	MKLEPADLO	P6700 Framing - Cell 2V01, KF1					=2V01&MFS-PNEU_KF1		+ V2AR42UQ42
		Appr		Replacement of		Replaced by	Scale 1:1		Document type:	Project nr:	Page
Modification	Date	Name	Original						MFS	22-16152	1
											275

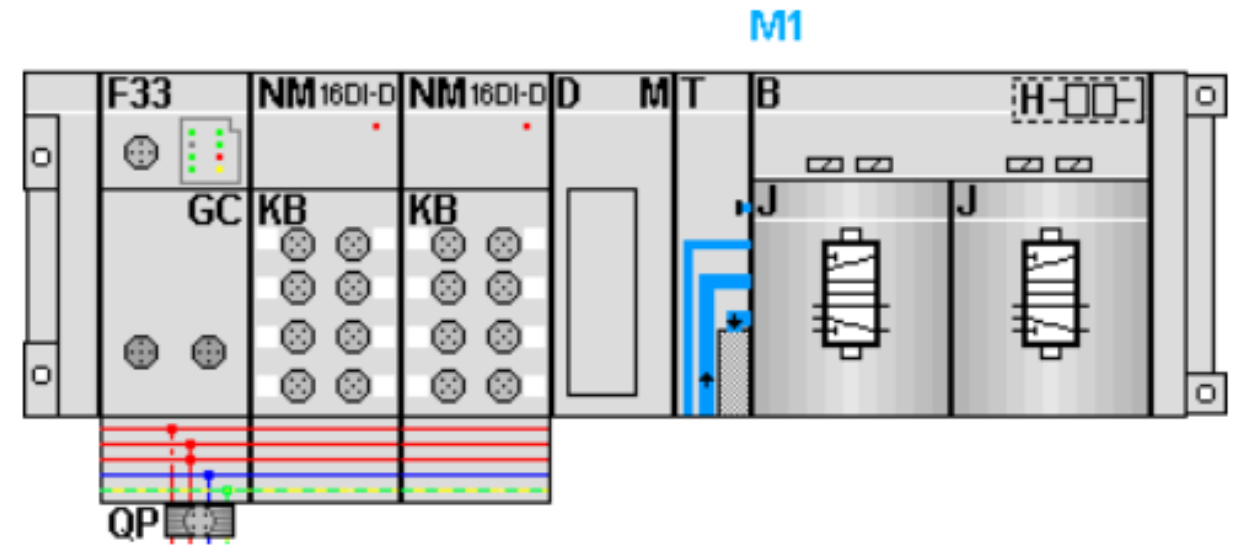

KF1.0

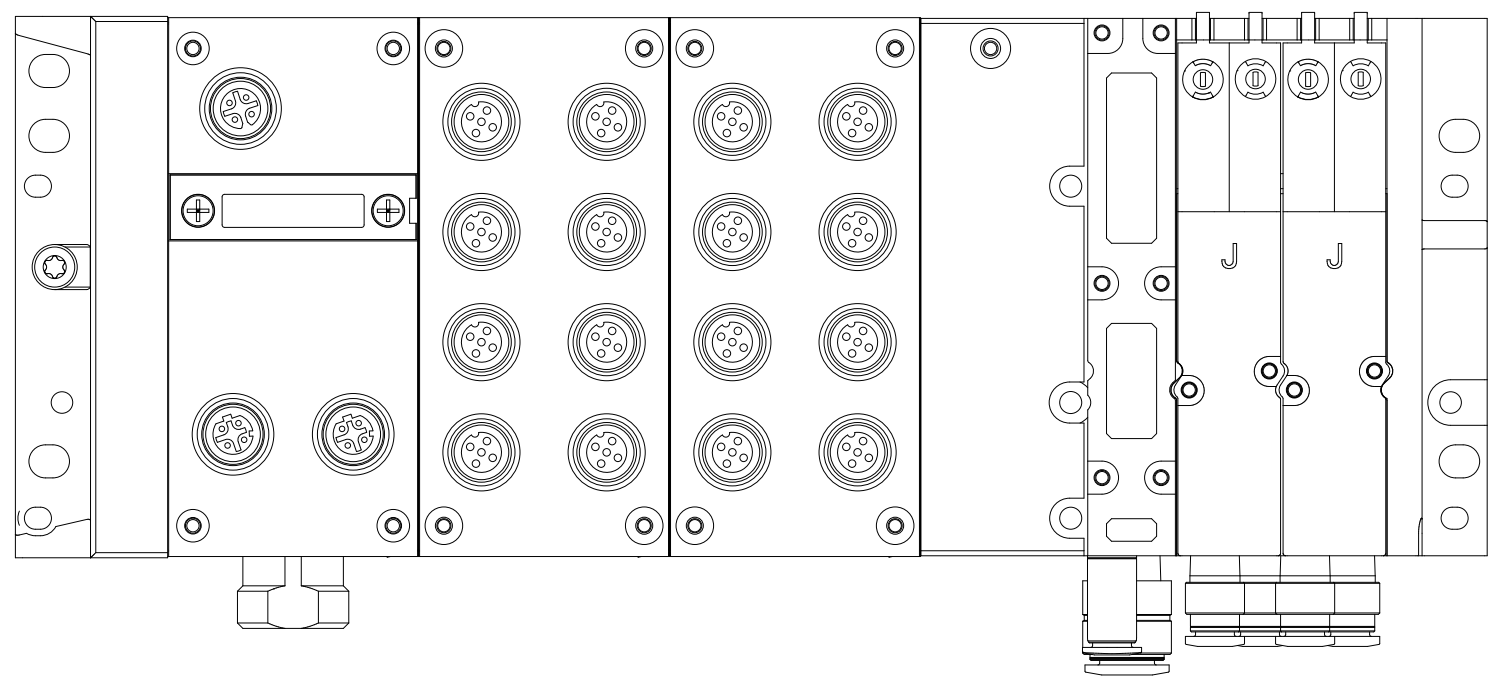

Date		1/17/2023		Volvo Trucks North America		Valiant TMS		AIR SUPPLY		Drawing name:		= V2AR42UQ42KF1	
Ed.		MKLEPADLO		P6700 Framing - Cell 2V01, KF1		Scale 1:1				Document type:		+ V2AR42UQ42	
Appr				Replacement of		Replaced by				Project nr:		Page	
Original										MFS		5	
										22-16152		275	

M1

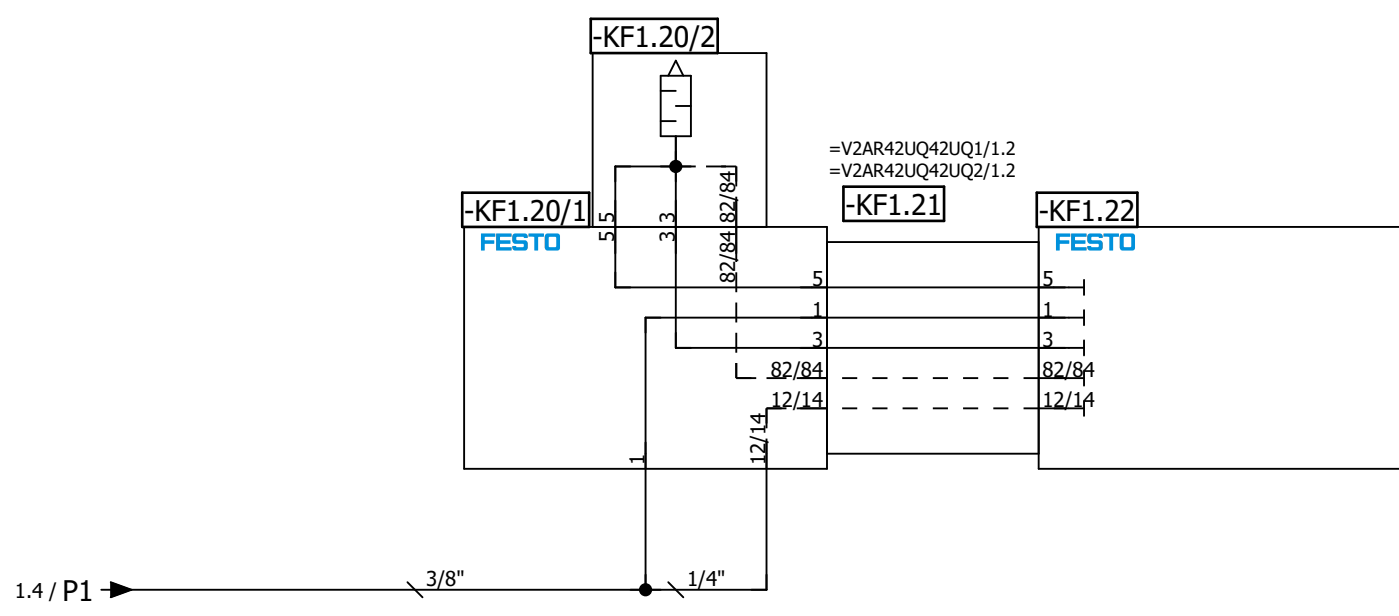
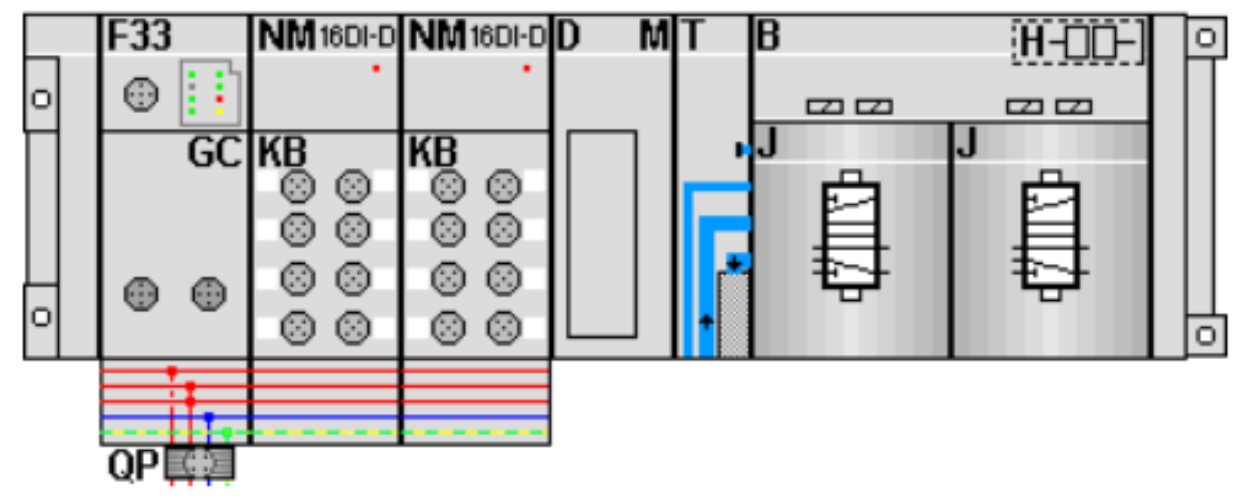

5

=V2AR42UQ42UQ1/1

			Date	1/17/2023	Volvo Trucks North America	Valiant TMS	AIR SUPPLY	Drawing name:		= V2AR42UQ42KF1	
			Ed.	MKLEPADLO				=2V01&MFS-PNEU_KF1		+ V2AR42UQ42	
			Appr					Document type:	MFS	Project nr:	22-16152
Modification	Date	Name	Original		Replacement of	Replaced by	Scale 1:1			Page	275

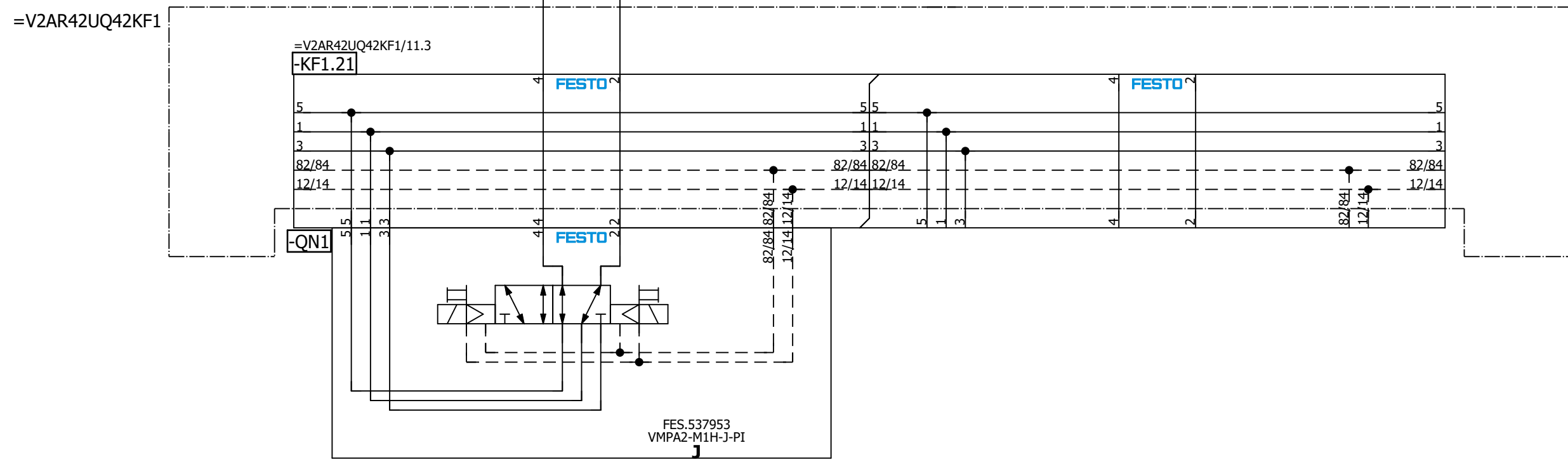
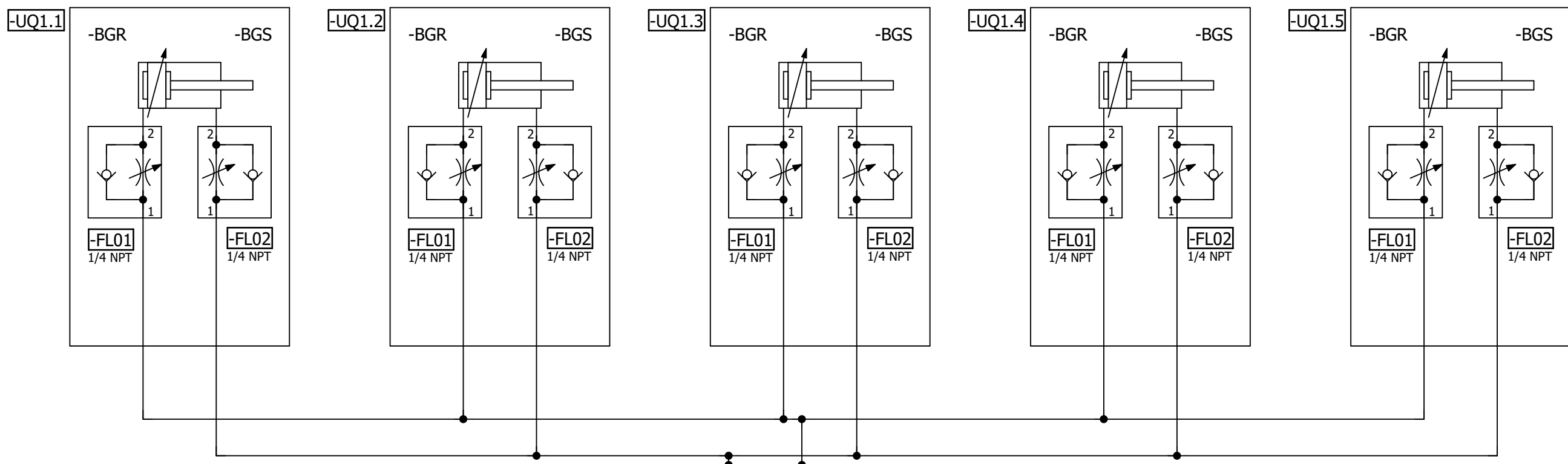

=V2AR42UQ42  
-UQ1-QN1.1  
L230/290/320  
Clamps (RST)

=V2AR42UQ42  
-UQ1-QN1.2  
L230/290/320  
Clamps (SET)

=V2AR42UQ42KF1/11

=V2AR42UQ42UQ2/1

Date: 1/17/2023		Volvo Trucks North America		Valiant TMS		L230/290/320 Model Clamps		Drawing name: =V2AR42UQ42UQ1		= V2AR42UQ42UQ1	
Ed.: MKLEPADLO		P6700 Framing - Cell 2V01, KF1		Scale 1:1				=V2AR42UQ42KF1/11.3		+ V2AR42UQ42	
Appr:		Replacement of		Replaced by				Document type: MFS		Project nr: 22-16152	
Modification		Date		Name		Original		Page		1	
										275	

=V2AR42UQ42KF1

=V2AR42UQ42KF1/11.3  
-KF1.21

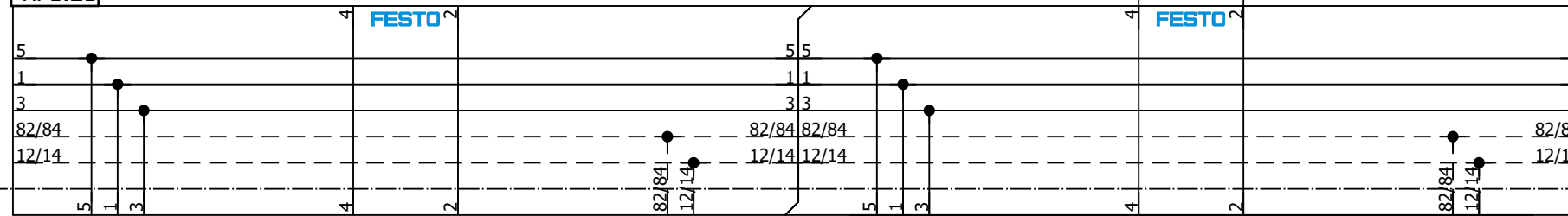

=V2AR42UQ42  
-UQ2-QN2.1  
Spare  
(RST)

=V2AR42UQ42  
-UQ2-QN2.2  
Spare  
(SET)

FES.537953  
VMPA2-M1H-J-PI

=V2AR43UQ41KF1+.AR43UQ41/1

=V2AR42UQ42UQ1/1

Date		12/20/2022		Volvo Trucks North America		Valiant TMS		Spare		Drawing name:		= V2AR42UQ42UQ2	
Ed.		MKLEPADLO		P6700 Framing - Cell 2V01, KF1		Scale 1:1				Document type:		+ V2AR42UQ42	
Appr.				Replacement of		Replaced by				Project nr:		Page	
Original										22-16152		1	
Modification		Date		Name		Original				MFS		275	

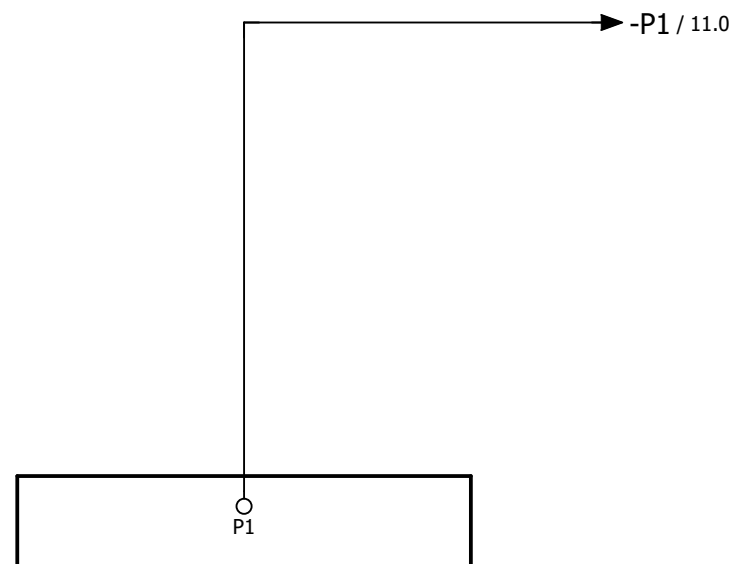

=V2AR42UQ42UQ2+.AR42UQ42/1

		Date	1/3/2023	Volvo Trucks North America			Valiant TMS	AIR SUPPLY GRIPPER	Drawing name:		= V2AR43UQ41KF1
		Ed.	MKLEPADLO	P6700 Framing - Cell 2V01, KF1					=2V01&MFS-PNEU_KF1		+ V2AR43UQ41
Modification	Date	Name	Original	Replacement of	Replaced by		Scale 1:1		Document type:	Project nr:	Page
									MFS	22-16152	1
											275



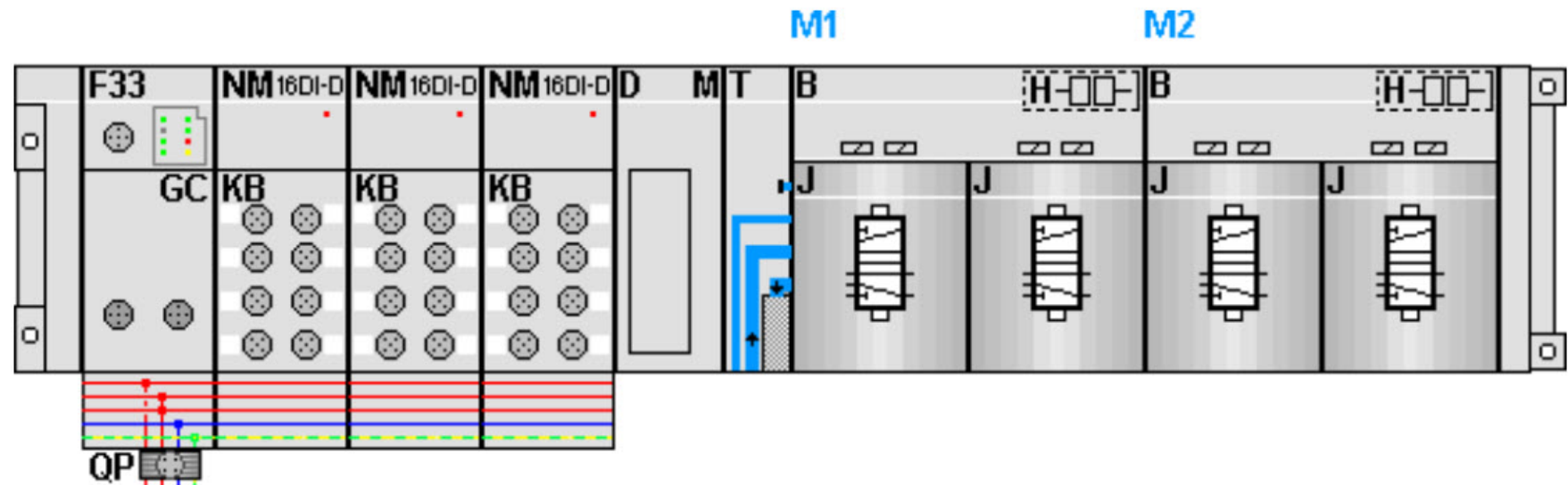

KF1.0

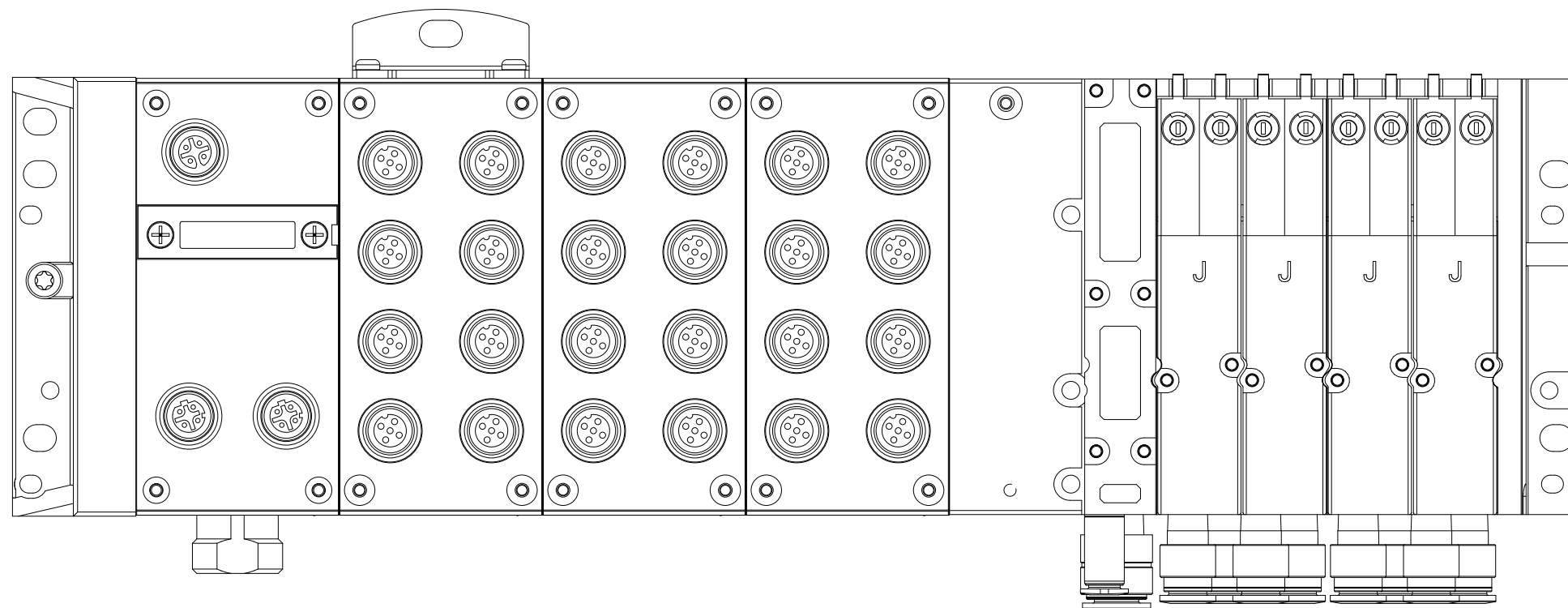

Date		1/17/2023	Volvo Trucks North America		Valiant TMS	AIR SUPPLY	Drawing name:		= V2AR43UQ41KF1
Ed.		MKLEPADLO	P6700 Framing - Cell 2V01, KF1				=2V01&MFS-PNEU_KF1		+ V2AR43UQ41
Appr			Replacement of		Scale 1:1		Document type:	Project nr:	Page
Modification	Date	Name	Original	Replaced by			MFS	22-16152	5
									275



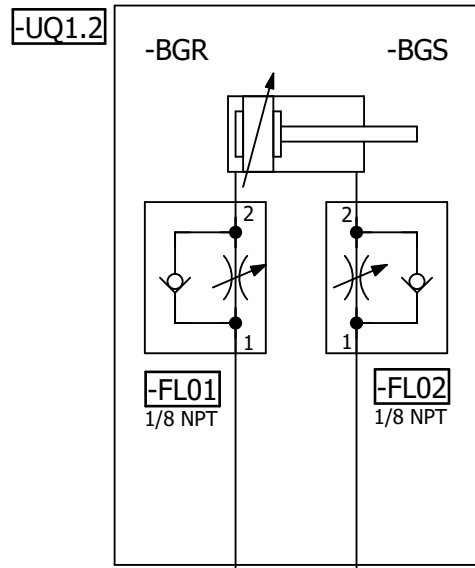
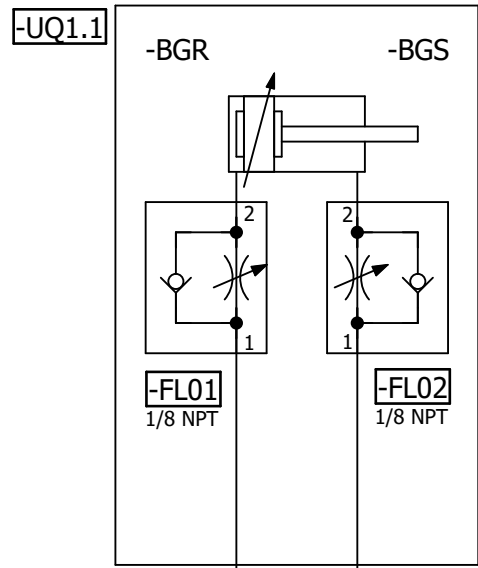

=V2AR43UQ41KF1

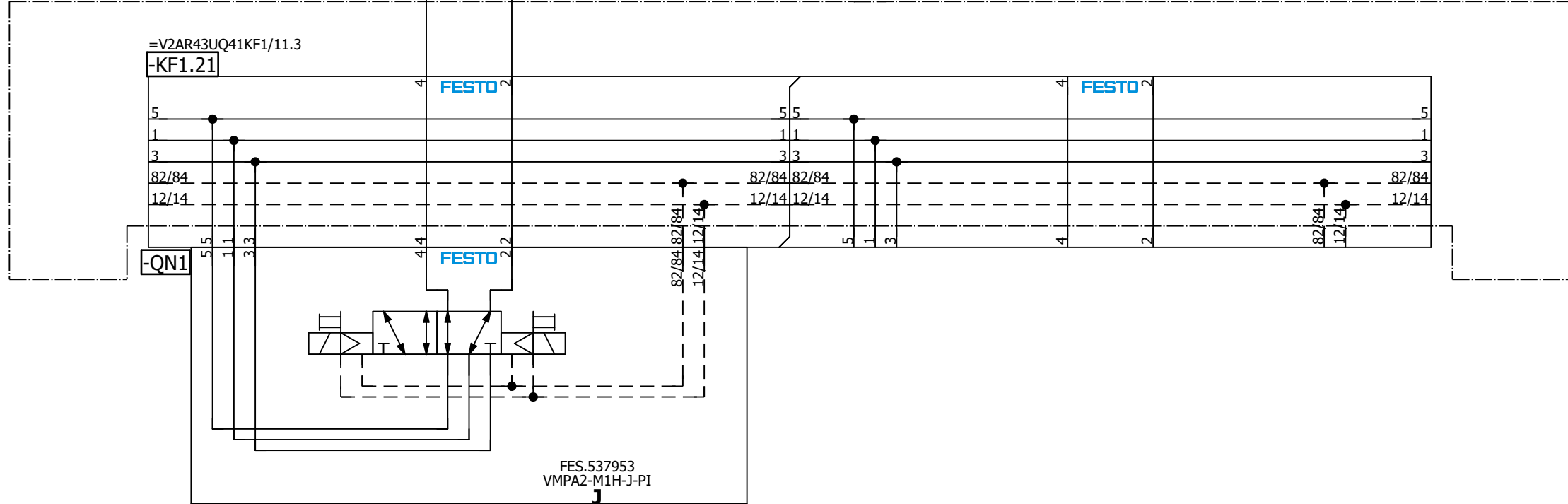

=V2AR43UQ41  
-UQ1-QN1.1  
L150 Model  
Shot Pins (RST)

=V2AR43UQ41  
-UQ1-QN1.2  
L150 Model  
Shot Pins (SET)

=V2AR43UQ41KF1/11

=V2AR43UQ41UQ2/1

Date: 1/17/2023		Volvo Trucks North America		Valiant TMS		Drawing name: =2V01&MFS-PNEU_KF1		= V2AR43UQ41UQ1	
Ed.: MKLEPADLO		P6700 Framing - Cell 2V01, KF1		L150 Model Shot Pins		Document type: MFS		+ V2AR43UQ41	
Appr:		Replacement of		Scale 1:1		Project nr: 22-16152		Page 1	
Original		Replaced by						275	

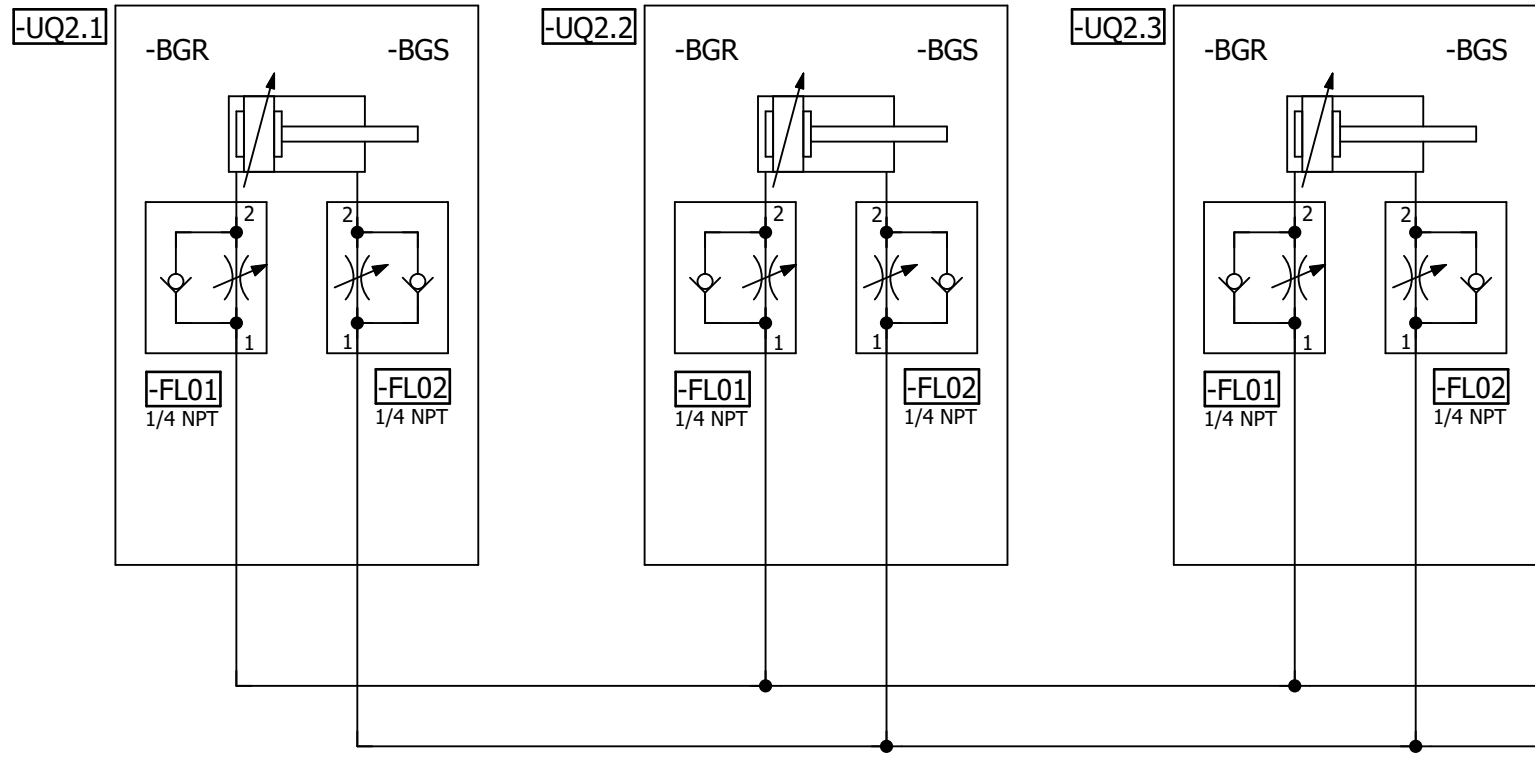

=V2AR43UQ41KF1

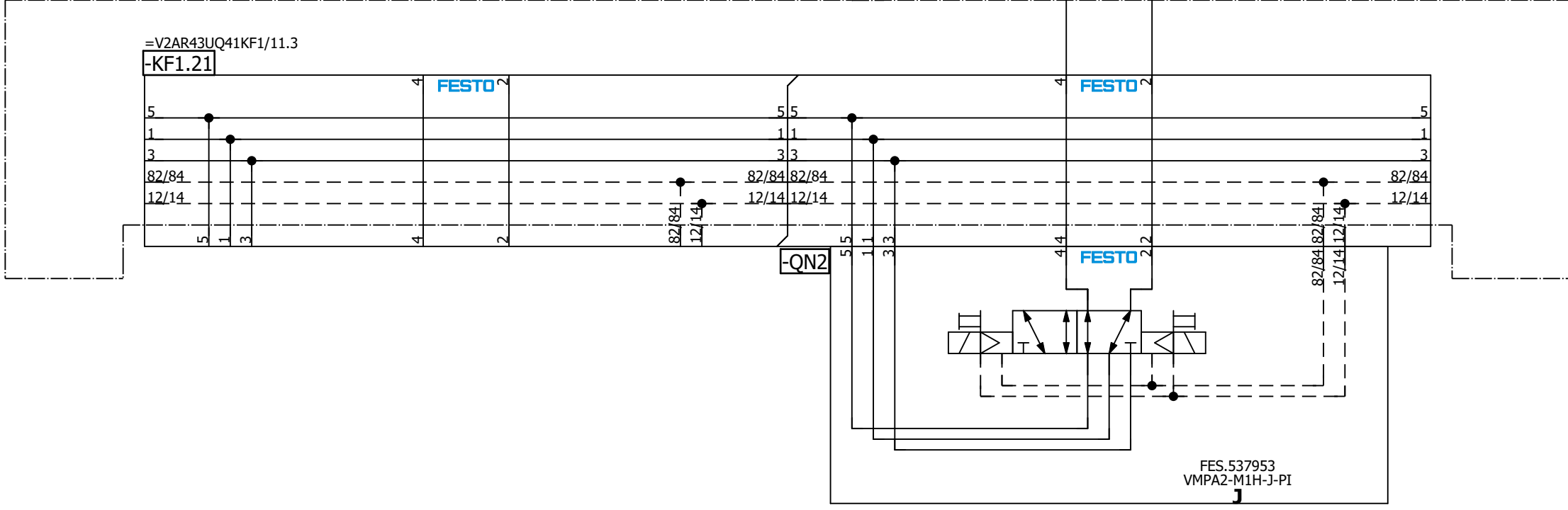

=V2AR43UQ41  
-UQ2-QN2.1  
L150 Model  
Clamps 1 (RST)

=V2AR43UQ41  
-UQ2-QN2.2  
L150 Model  
Clamps 1 (SET)

=V2AR43UQ41UQ3/1

=V2AR43UQ41UQ1/1			Date	1/17/2023	Volvo Trucks North America	Valiant TMS	L150 Model Clamps 1	Drawing name:	=V2AR43UQ41UQ2	Page	1
			Ed.	MKLEPADLO	P6700 Framing - Cell 2V01, KF1	Scale 1:1		Document type:	MFS	Project nr:	22-16152
Modification			Date	Name				Original	Replaced by		

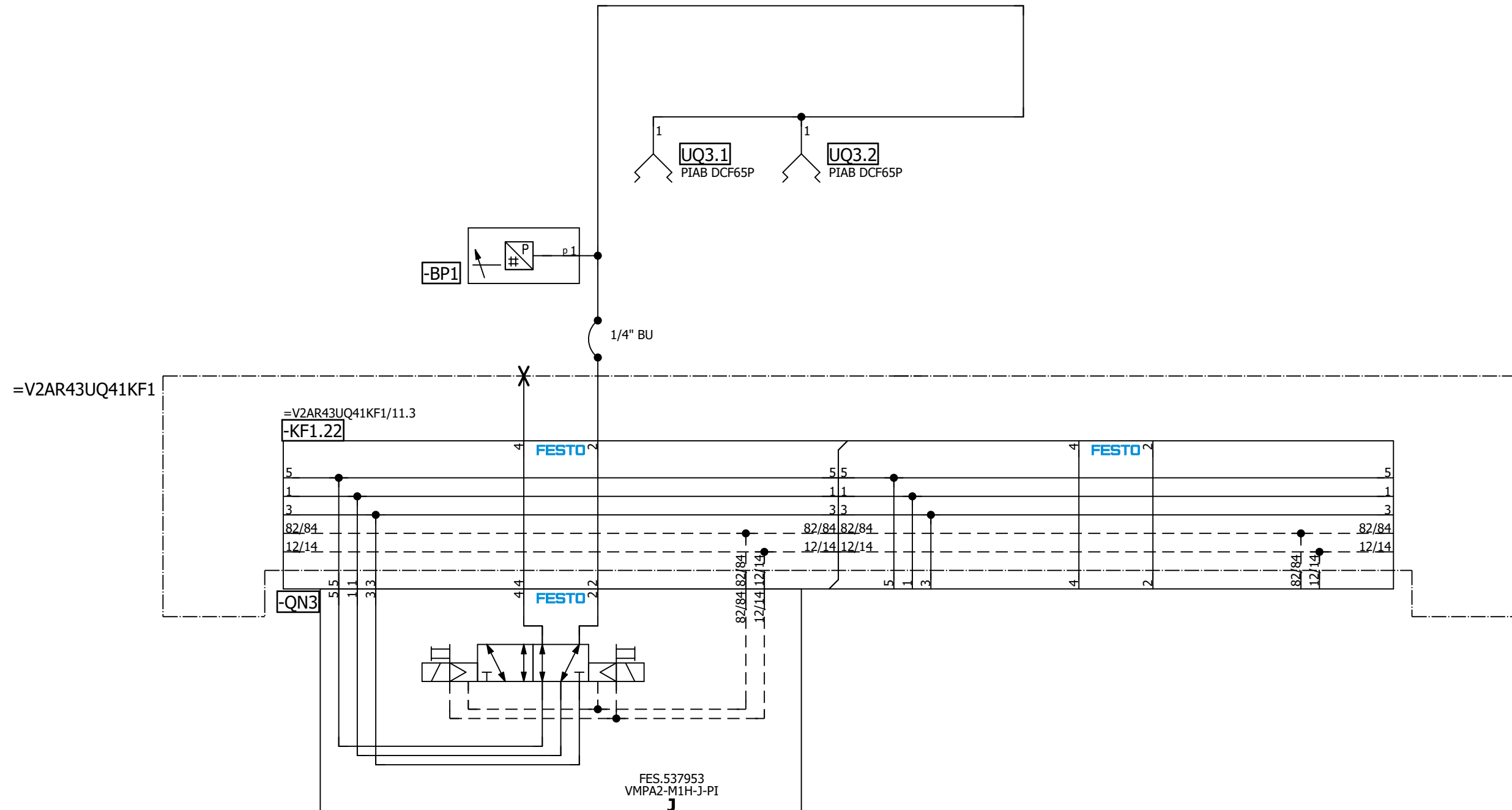

=V2AR43UQ41  
-UQ3-QN3.1  
L150 Model  
Vacuums (RST)

=V2AR43UQ41  
-UQ3-QN3.2  
L150 Model  
Vacuums (SET)

=V2AR43UQ41UQ2/1

=V2AR43UQ41UQ4/1

Date		12/20/2022		Volvo Trucks North America		Valiant TMS		L150 Model Vacuums		Drawing name:		= V2AR43UQ41UQ3	
Ed.		MKLEPADLO		P6700 Framing - Cell 2V01, KF1		Scale 1:1				Document type:		= V2AR43UQ41	
Appr.				Replacement of		Replaced by				Project nr:		Page	
Original										MFS		275	
Modification		Date		Name		Original				22-16152		1	

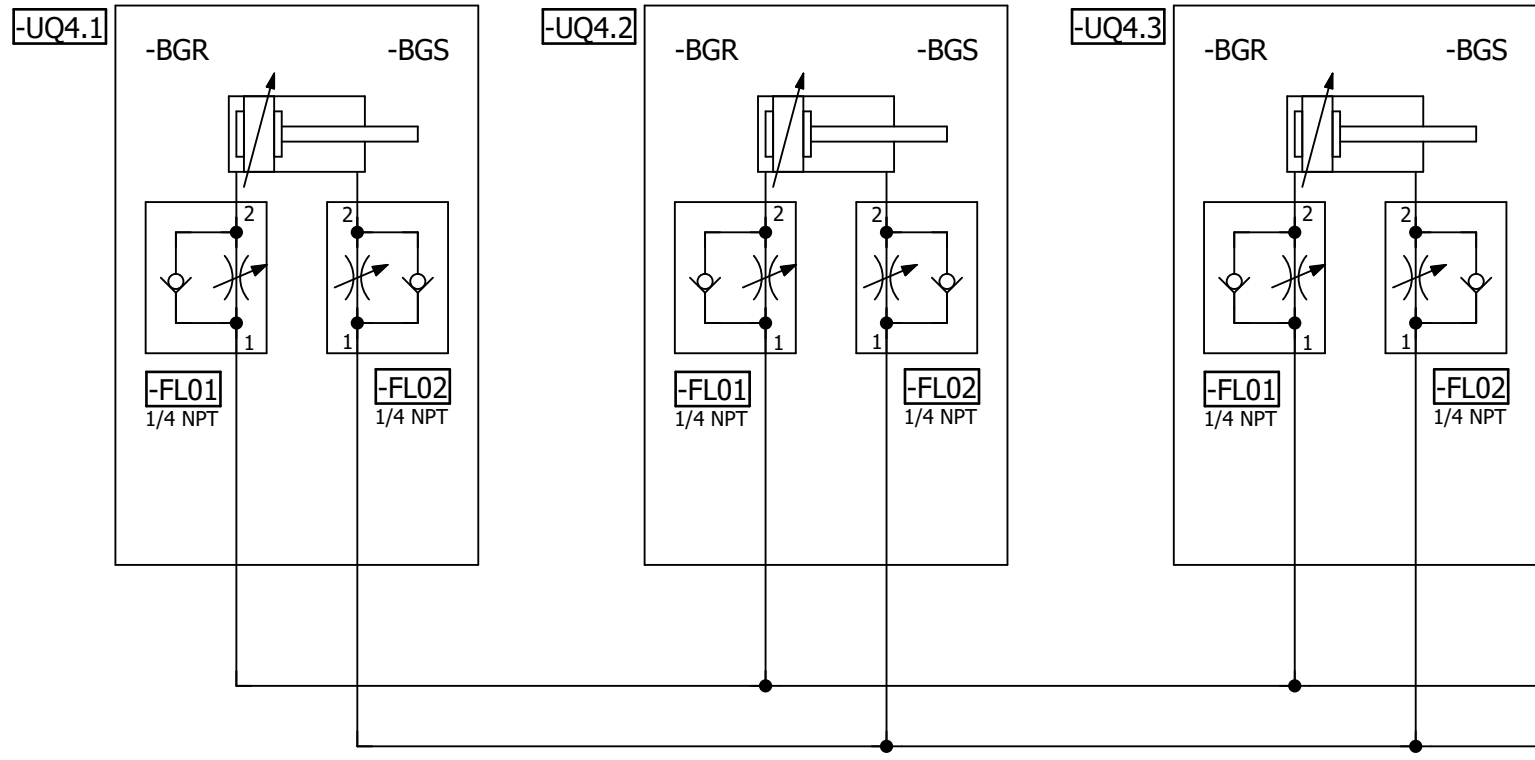

=V2AR43UQ41KF1

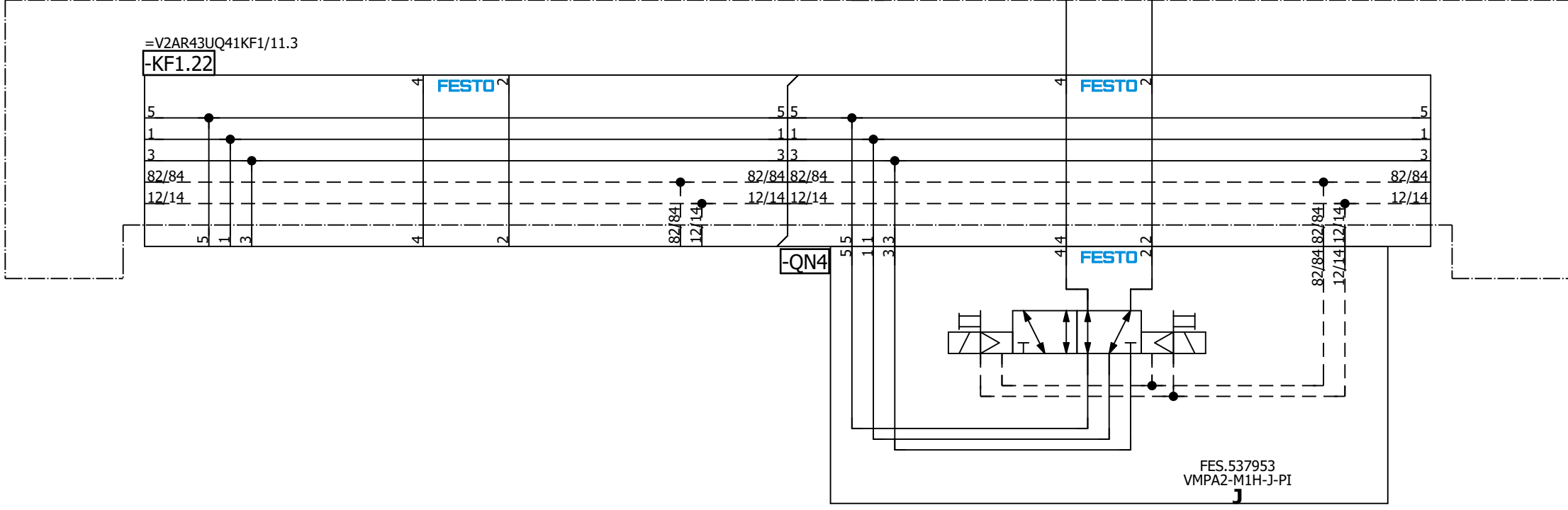

=V2AR43UQ41  
-UQ4-QN4.1  
L150 Model  
Clamps 2 (RST)

=V2AR43UQ41  
-UQ4-QN4.2  
L150 Model  
Clamps 2 (SET)

=V2AR43UQ42KF1+.AR43UQ42/1

=V2AR43UQ41UQ3/1

Date		1/17/2023		Volvo Trucks North America		Valiant TMS		L150 Model Clamps 2		Drawing name:		= V2AR43UQ41UQ4	
Ed.		MKLEPADLO		P6700 Framing - Cell 2V01, KF1		Scale 1:1				Document type:		= V2AR43UQ41	
Appr.				Replacement of		Replaced by				Project nr:		Page	
Original										22-16152		1	
Modification		Date		Name		Original				MFS		275	

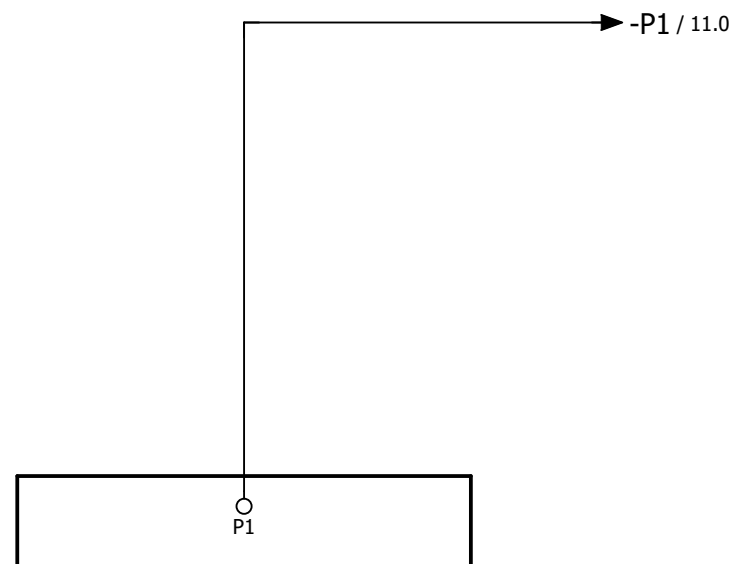

=V2AR43UQ41UQ4+.AR43UQ41/1

		Date	1/3/2023	Volvo Trucks North America			Valiant TMS	AIR SUPPLY GRIPPER	Drawing name:		= V2AR43UQ42KF1
		Ed.	MKLEPADLO	P6700 Framing - Cell 2V01, KF1					=2V01&MFS-PNEU_KF1		+ V2AR43UQ42
Modification	Date	Name	Original	Replacement of	Replaced by		Scale 1:1		Document type:	Project nr:	Page
									MFS	22-16152	1
											275

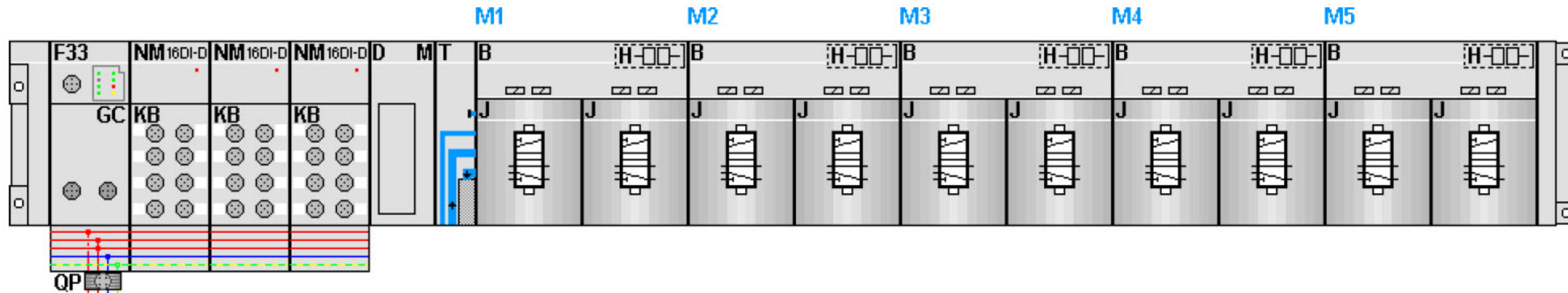

KF1.0

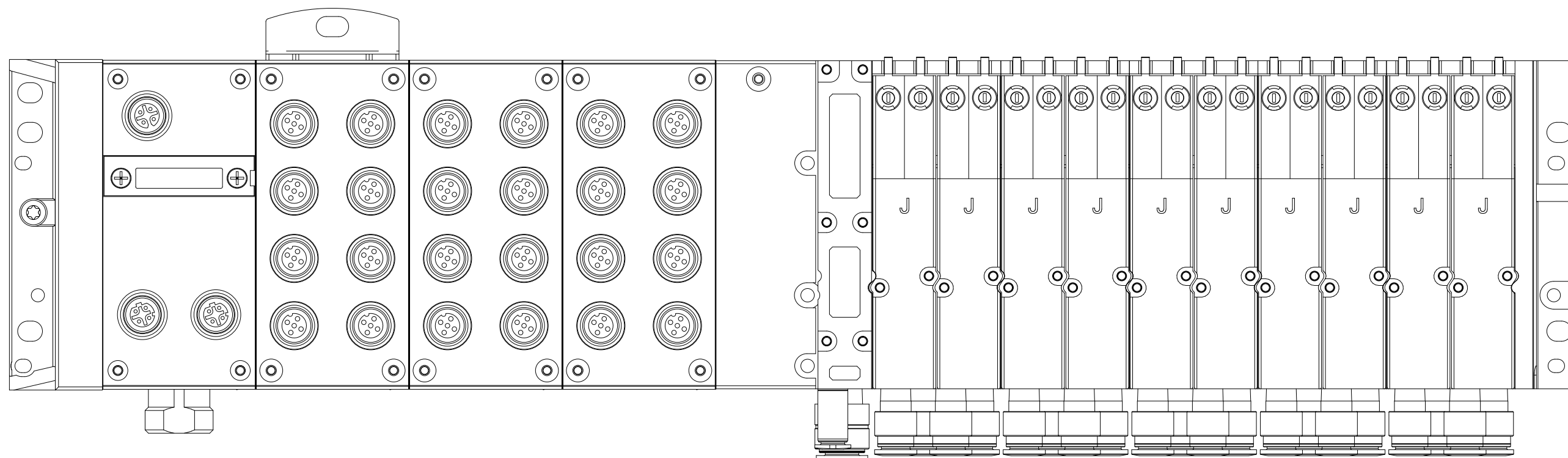

Date		1/17/2023		Volvo Trucks North America		Valiant TMS		AIR SUPPLY		Drawing name:		= V2AR43UQ42KF1	
Ed.		MKLEPADLO		P6700 Framing - Cell 2V01, KF1		Scale 1:1				Document type:		+ V2AR43UQ42	
Appr				Replacement of		Replaced by				Project nr:		Page	
Original										22-16152		5	
Modification		Date		Name						MFS		275	



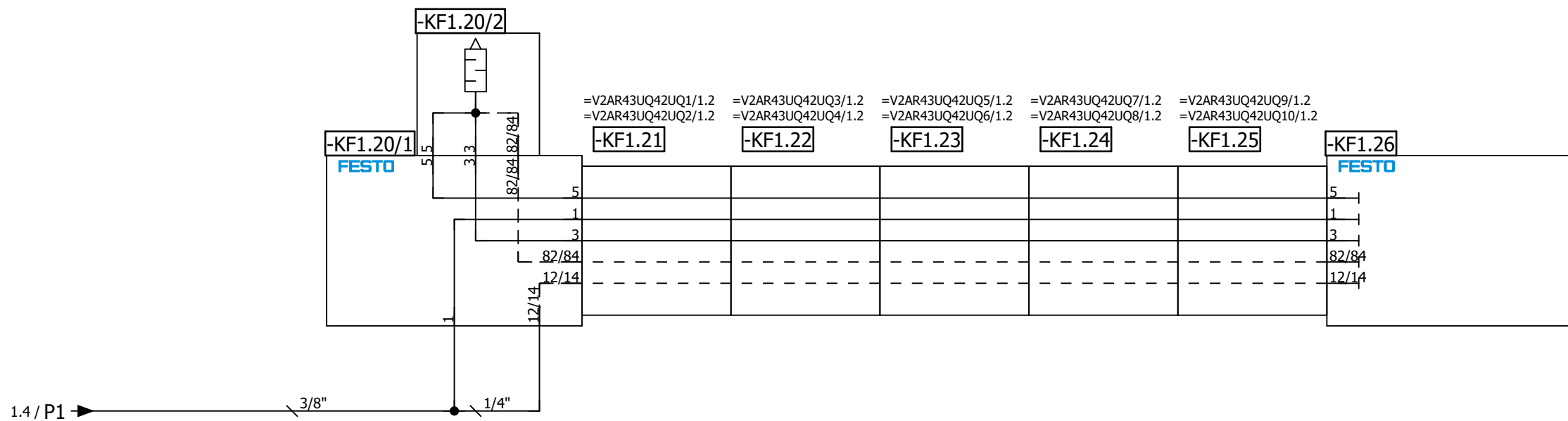
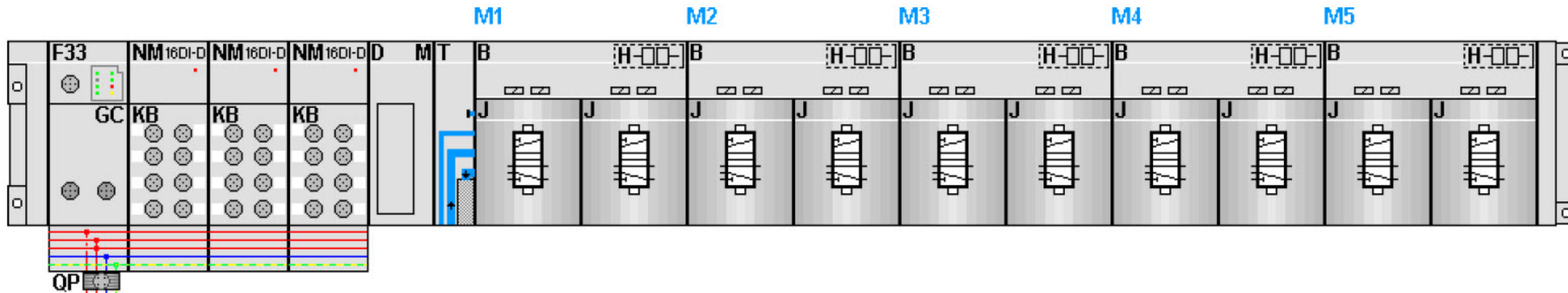



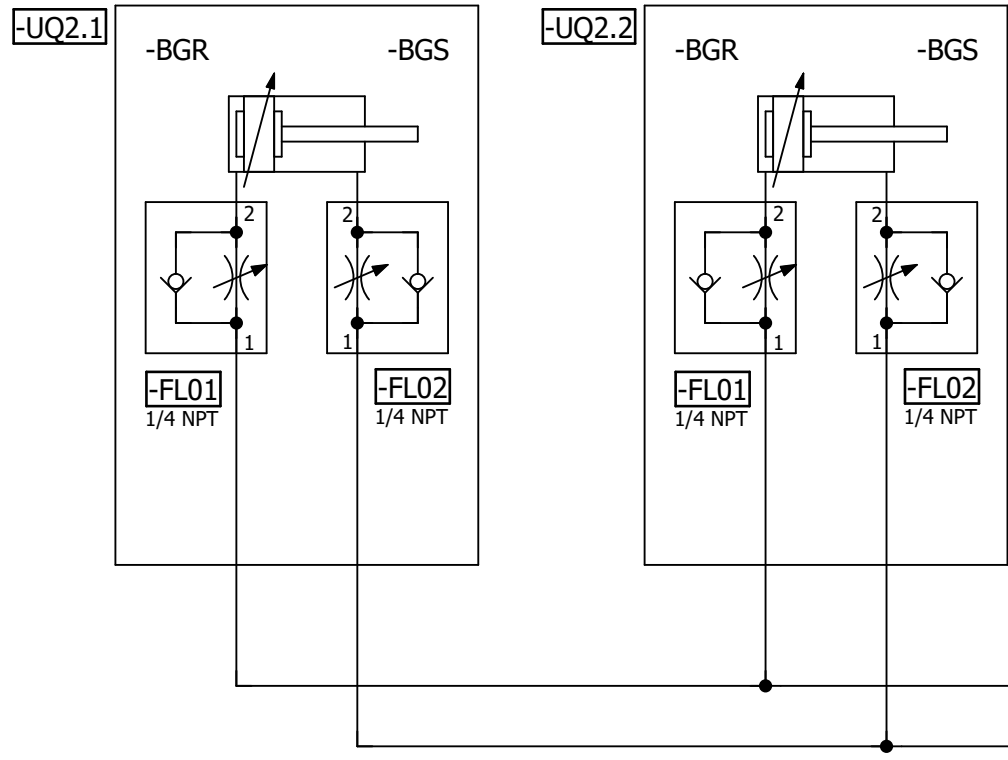

=V2AR43UQ42KF1

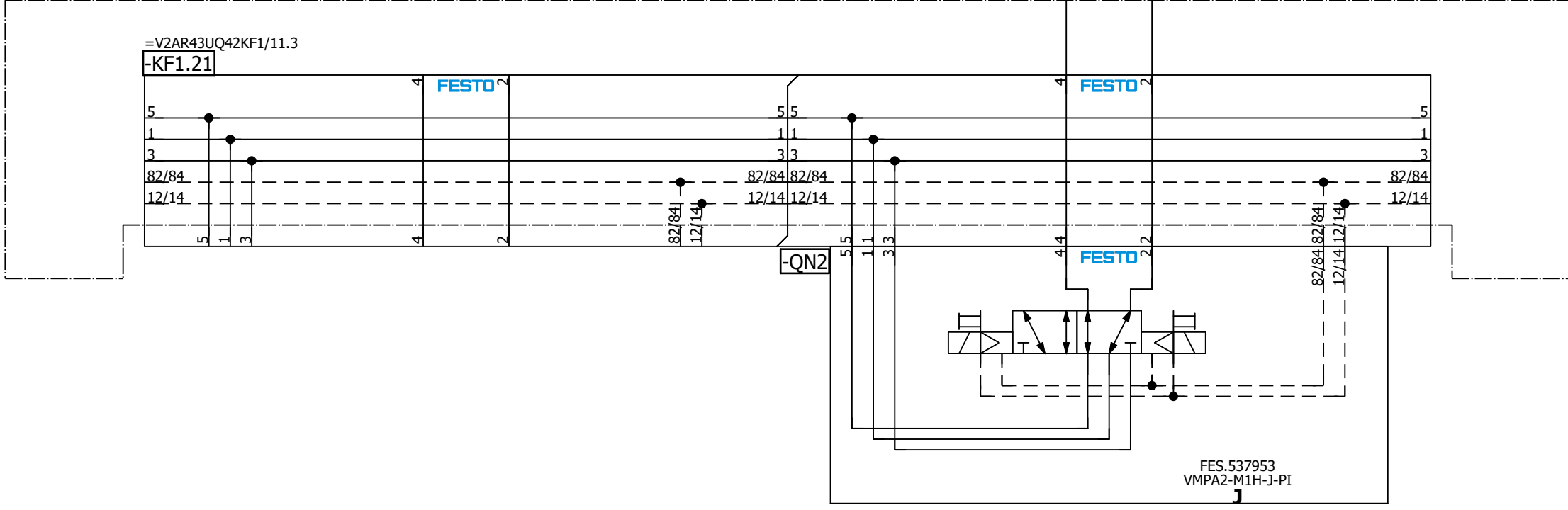

=V2AR43UQ42  
-UQ2-QN2.1  
L290 Model  
Clamps 1 (RST)

=V2AR43UQ42  
-UQ2-QN2.2  
L290 Model  
Clamps 1 (SET)

=V2AR43UQ42UQ1/1

=V2AR43UQ42UQ3/1

			Date	1/17/2023	Volvo Trucks North America		Valiant TMS	L290 Model Clamps 1	Drawing name:	= V2AR43UQ42UQ2	
			Ed.	MKLEPADLO	P6700 Framing - Cell 2V01, KF1				=2V01&MFS-PNEU_KF1	= V2AR43UQ42	
			Appr.		Replacement of	Replaced by	Scale 1:1		Document type:	Project nr:	Page
Modification	Date	Name	Original						MFS	22-16152	1
											275

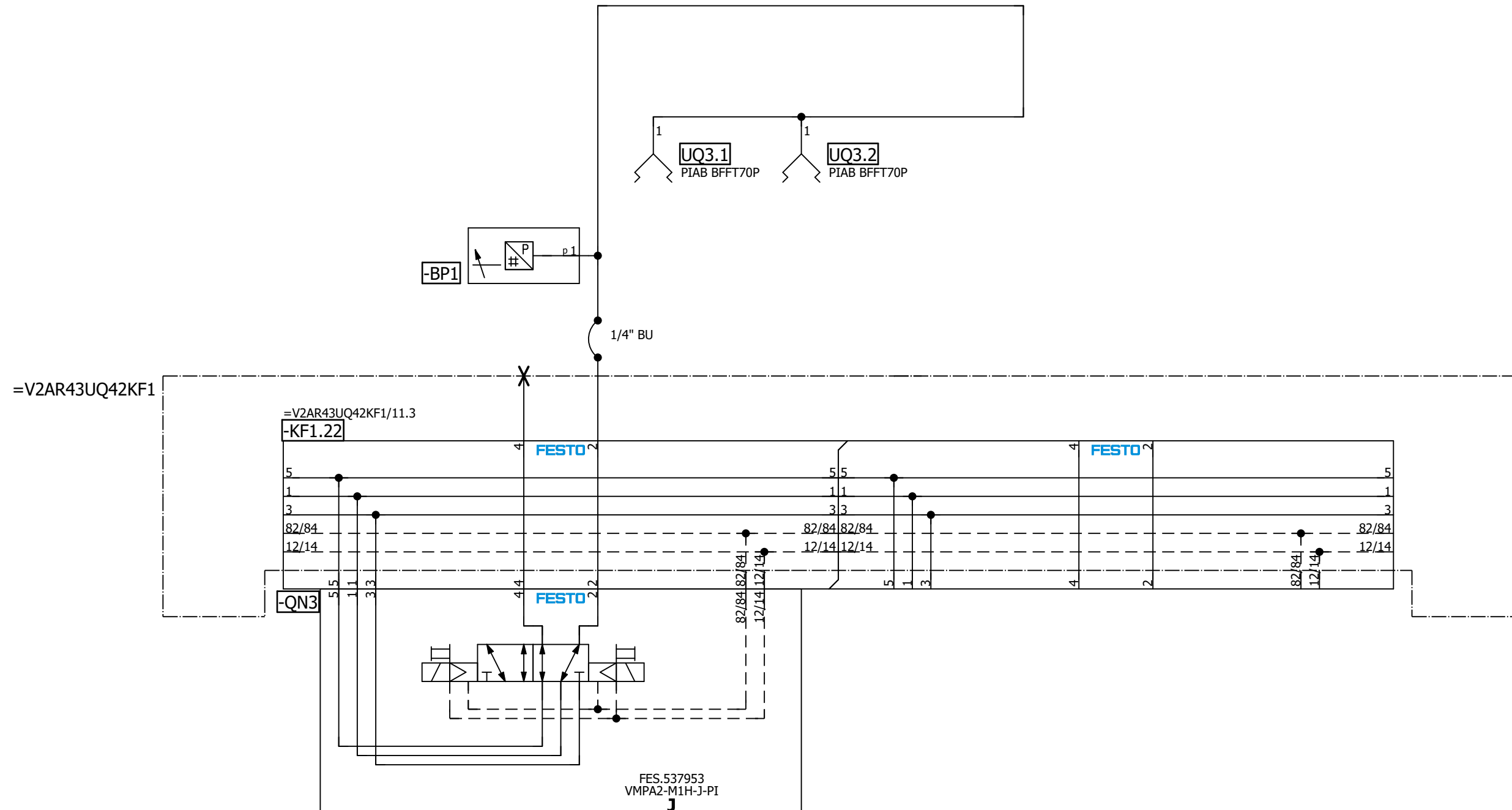

**=V2AR43UQ42**  
**-UQ3-QN3.1**  
**L290/320 Model**  
**Vacuums (RST)**

**=V2AR43UQ42**  
**-UQ3-QN3.2**  
**L290/320 Model**  
**Vacuums (SET)**

**=V2AR43UQ42UQ2/1**

**=V2AR43UQ42UQ4/1**

Date		12/20/2022		Volvo Trucks North America		Valiant TMS		L290/320 Model Vacuums		Drawing name:		= V2AR43UQ42UQ3	
Ed.		MKLEPADLO		P6700 Framing - Cell 2V01, KF1		Scale 1:1				Document type:		= V2AR43UQ42	
Appr.				Replacement of		Replaced by				Project nr:		Page	
Original										MFS		275	
Modification		Date		Name		Original				22-16152		1	

















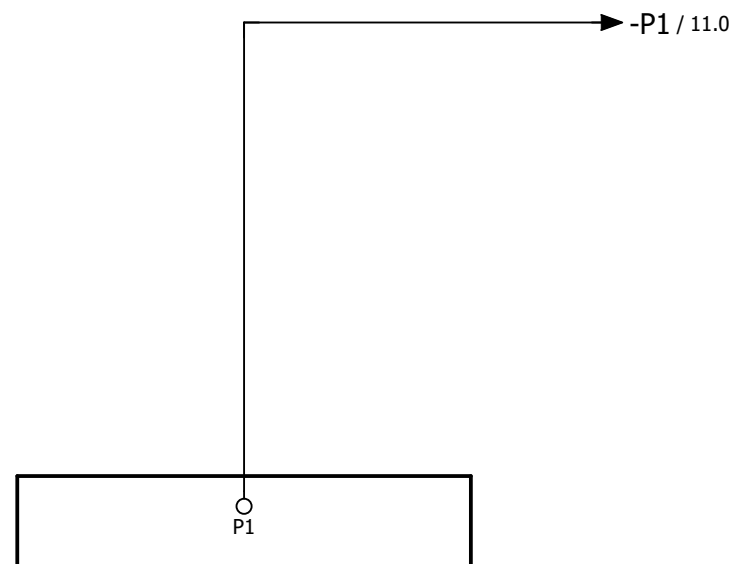



=V2AR43UQ42UQ10+.AR43UQ42/1

		Date	1/3/2023	Volvo Trucks North America			Valiant TMS	AIR SUPPLY GRIPPER	Drawing name:		= V2AR43UQ43KF1
		Ed.	MKLEPADLO	P6700 Framing - Cell 2V01, KF1					=2V01&MFS-PNEU_KF1		+ V2AR43UQ43
Modification	Date	Name	Original	Replacement of	Replaced by		Scale 1:1		Document type:	Project nr:	Page
									MFS	22-16152	1
											275

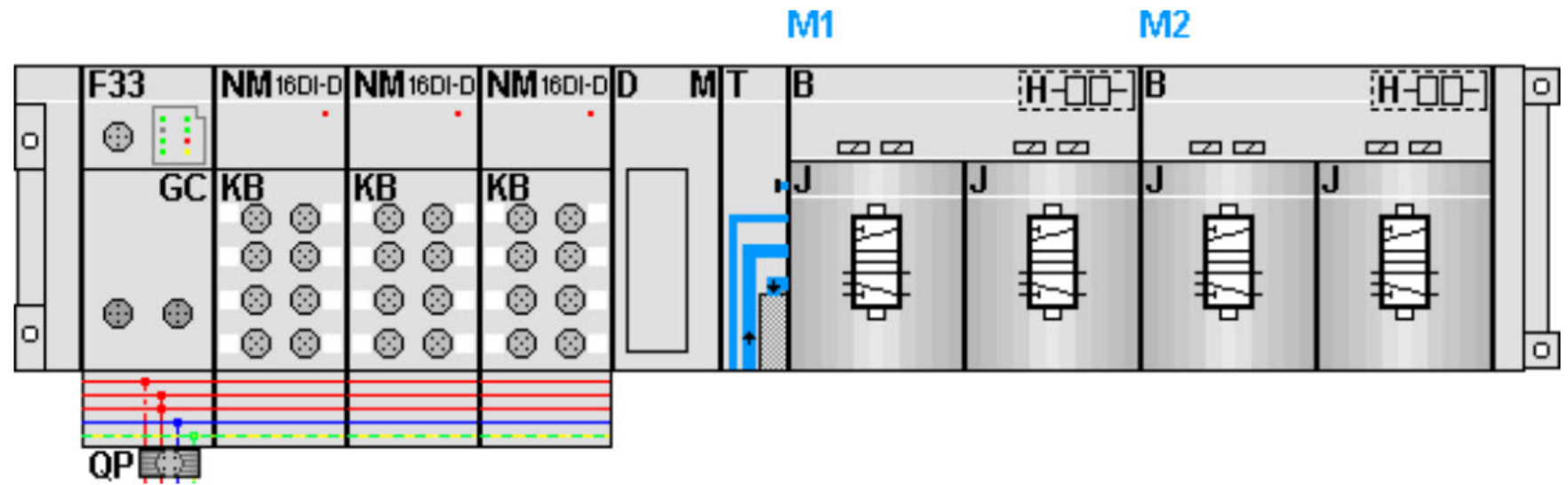

KF1.0

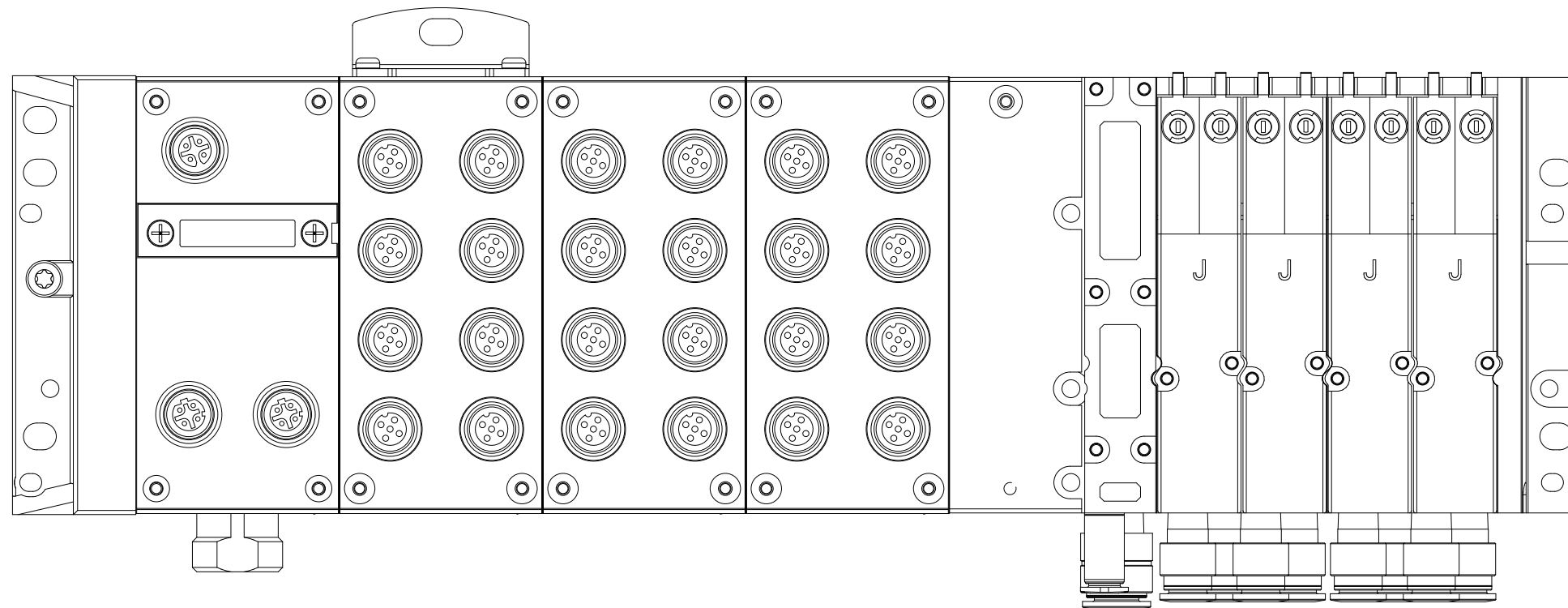

Date		1/17/2023		Volvo Trucks North America		Valiant TMS		AIR SUPPLY		Drawing name:		= V2AR43UQ43KF1	
Ed.		MKLEPADLO		P6700 Framing - Cell 2V01, KF1		Scale 1:1				Document type:		+ V2AR43UQ43	
Appr				Replacement of		Replaced by				Project nr:		Page	
Original										MFS		5	
										22-16152		275	



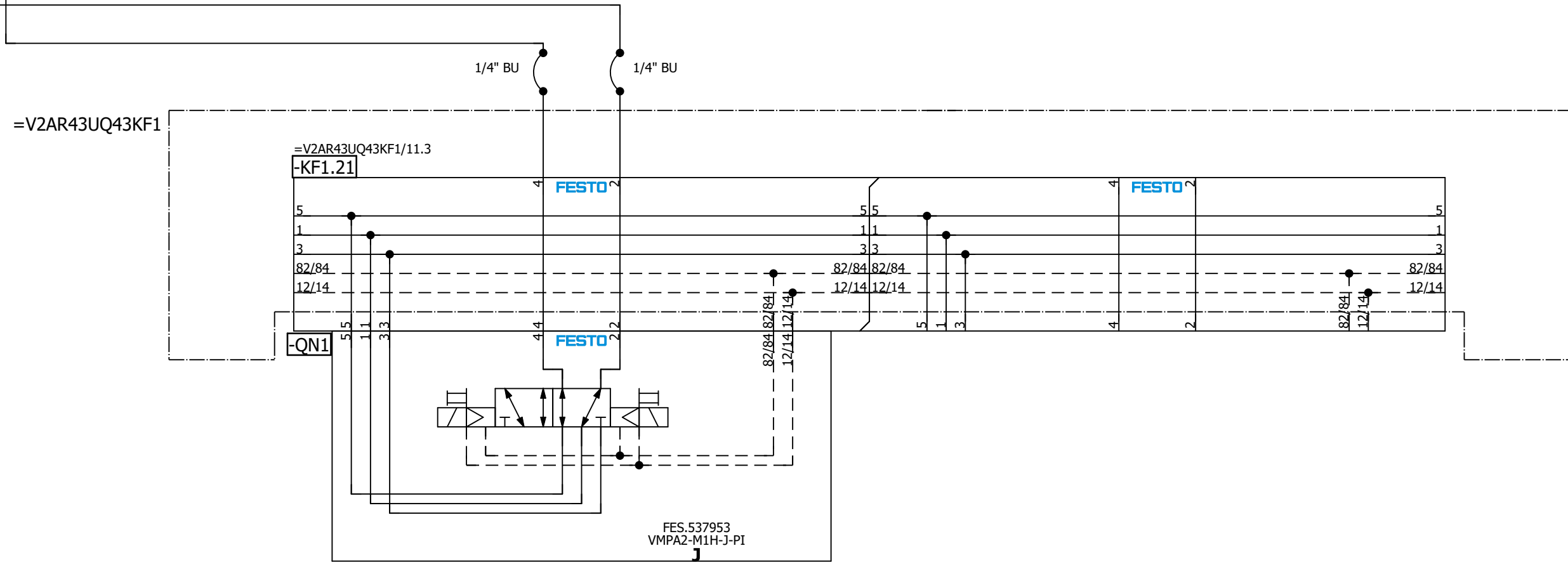
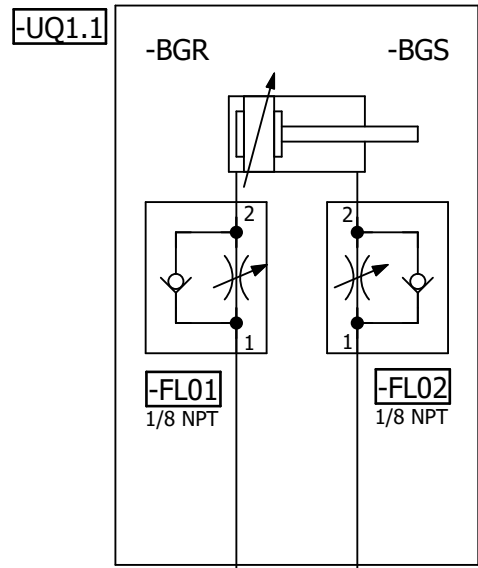

=V2AR43UQ43  
-UQ1-QN1.1  
L230 Model  
Shot Pin (RST)

=V2AR43UQ43  
-UQ1-QN1.2  
L230 Model  
Shot Pin (SET)

=V2AR43UQ43KF1/11

=V2AR43UQ43UQ2/1

Date		1/17/2023	Volvo Trucks North America		Valiant TMS	L230 Model Shot Pin	Drawing name:		= V2AR43UQ43UQ1
Ed.		MKLEPADLO	P6700 Framing - Cell 2V01, KF1				=2V01&MFS-PNEU_KF1		+ V2AR43UQ43
Appr			Replacement of		Scale 1:1		Document type:		Project nr:
Modification	Date	Name	Original	Replaced by			MFS	22-16152	Page
									275









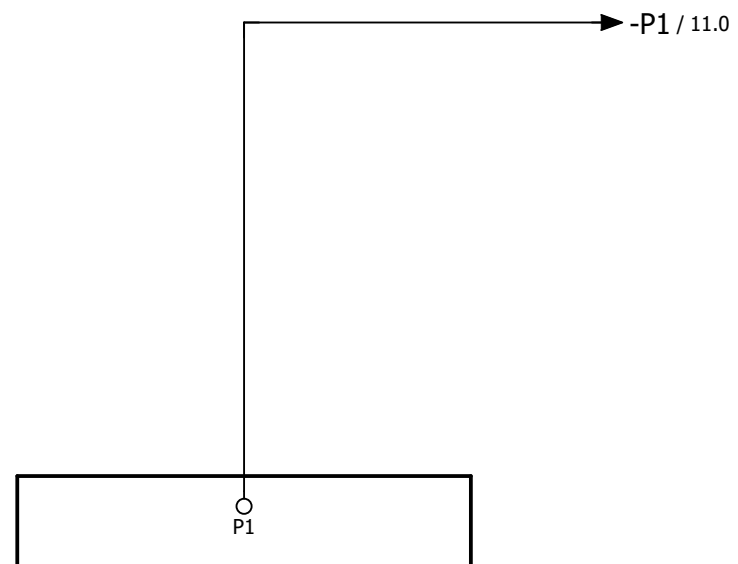

=V2AR43UQ43UQ4+.AR43UQ43/1

		Date	1/3/2023	Volvo Trucks North America			Valiant TMS	AIR SUPPLY GRIPPER	Drawing name:		= V2AR44UQ41KF1
		Ed.	MKLEPADLO	P6700 Framing - Cell 2V01, KF1					=2V01&MFS-PNEU_KF1		+ V2AR44UQ41
Modification	Date	Name	Original	Replacement of	Replaced by		Scale 1:1		Document type:	Project nr:	Page
									MFS	22-16152	1
											275





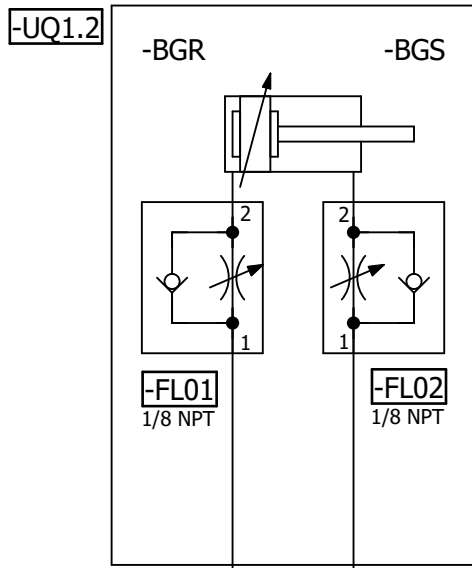
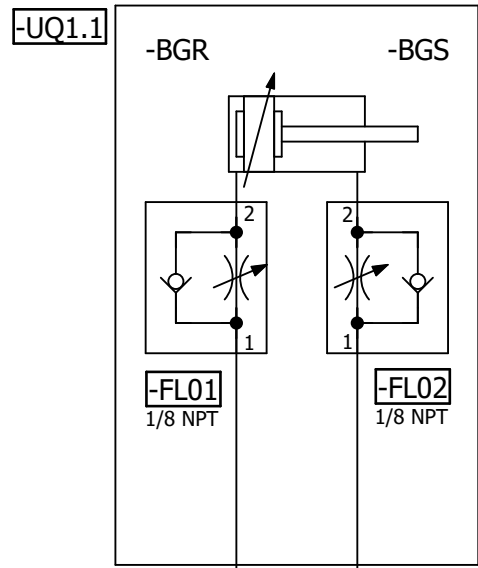

=V2AR44UQ41KF1

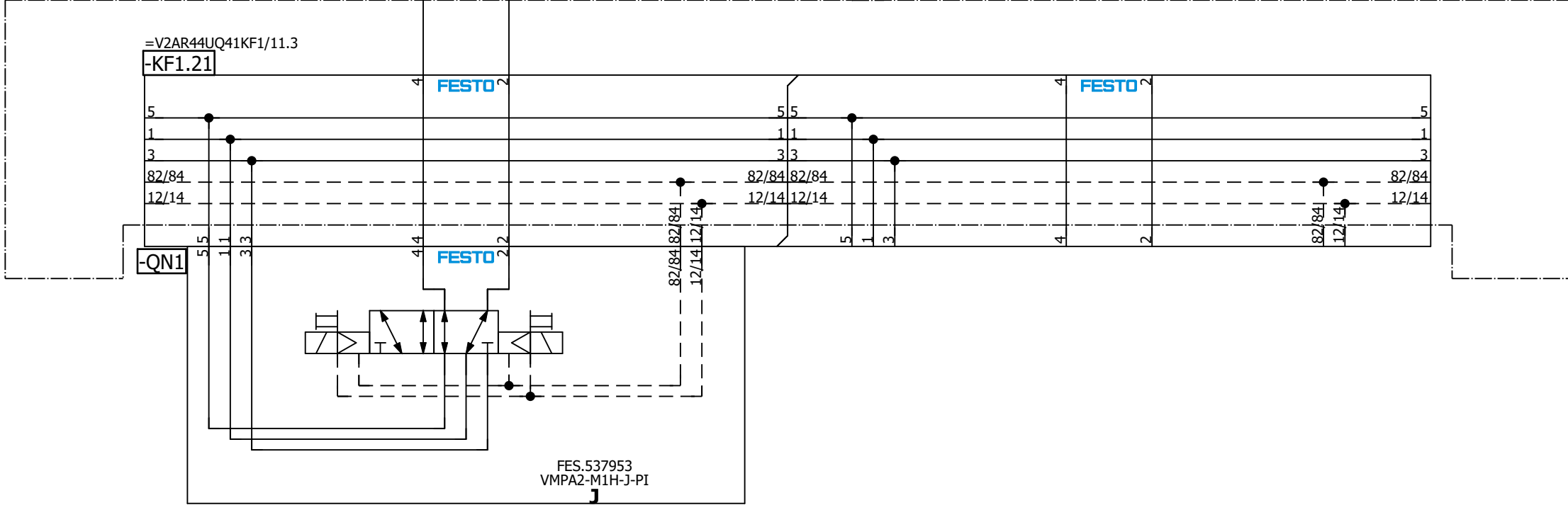

=V2AR44UQ41  
-UQ1-QN1.1  
L150 Model  
Shot Pins (RST)

=V2AR44UQ41  
-UQ1-QN1.2  
L150 Model  
Shot Pins (SET)

=V2AR44UQ41KF1/11

=V2AR44UQ41UQ2/1

Date: 1/17/2023		Volvo Trucks North America		Valiant TMS		Drawing name: =V2AR44UQ41UQ1		= V2AR44UQ41UQ1	
Ed.: MKLEPADLO		P6700 Framing - Cell 2V01, KF1		L150 Model Shot Pins		Document type: MFS		+ V2AR44UQ41	
Appr:		Replacement of		Scale 1:1		Project nr: 22-16152		Page 1	
Original		Replaced by						275	

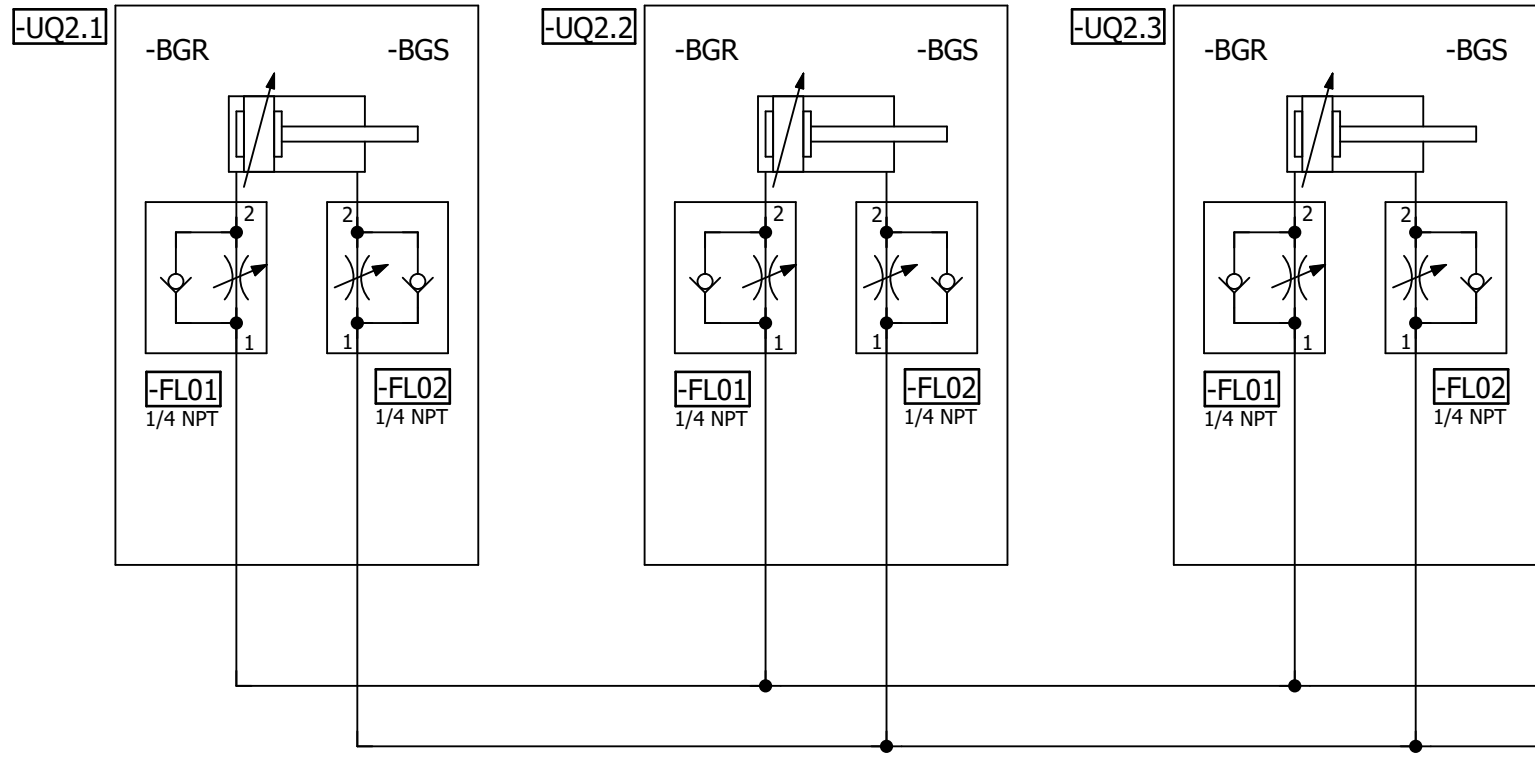

=V2AR44UQ41KF1

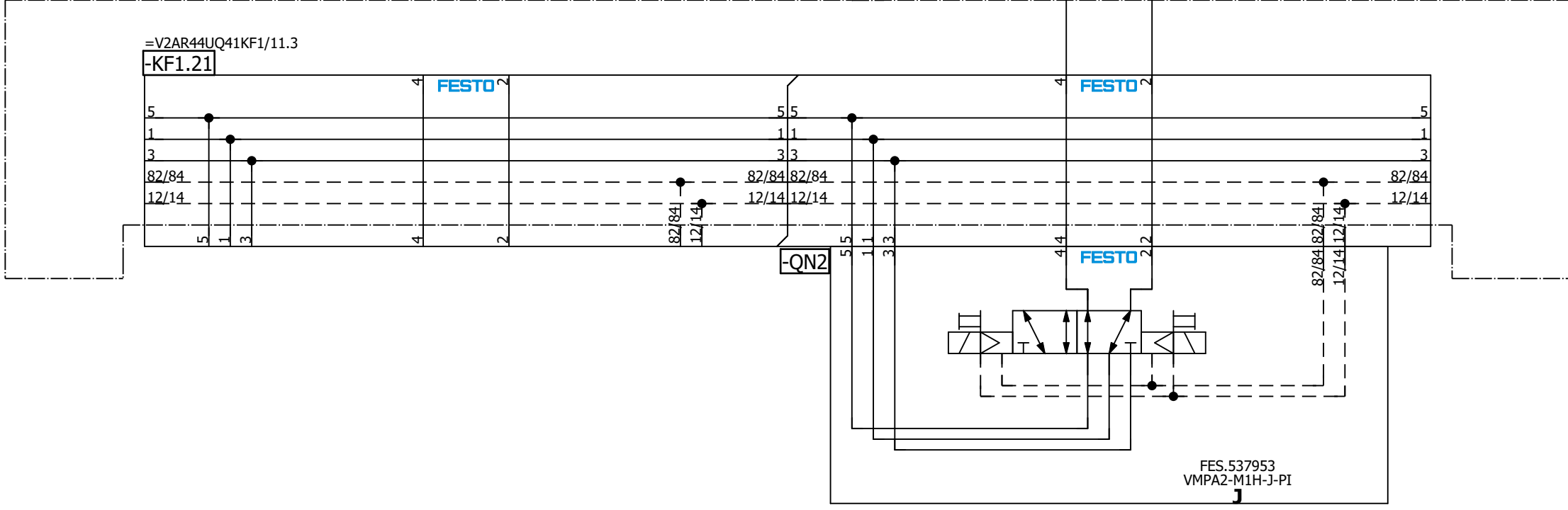

=V2AR44UQ41  
-UQ2-QN2.1  
L150 Model  
Clamps 1 (RST)

=V2AR44UQ41  
-UQ2-QN2.2  
L150 Model  
Clamps 1 (SET)

=V2AR44UQ41UQ1/1

=V2AR44UQ41UQ3/1

Date		1/17/2023		Volvo Trucks North America		Valiant TMS		L150 Model Clamps 1		Drawing name:		= V2AR44UQ41UQ2	
Ed.		MKLEPADLO		P6700 Framing - Cell 2V01, KF1		Scale 1:1				Document type:		+ V2AR44UQ41	
Appr.				Replacement of		Replaced by				Project nr:		Page	
Original										22-16152		1	
Modification		Date		Name		Original				MFS		275	

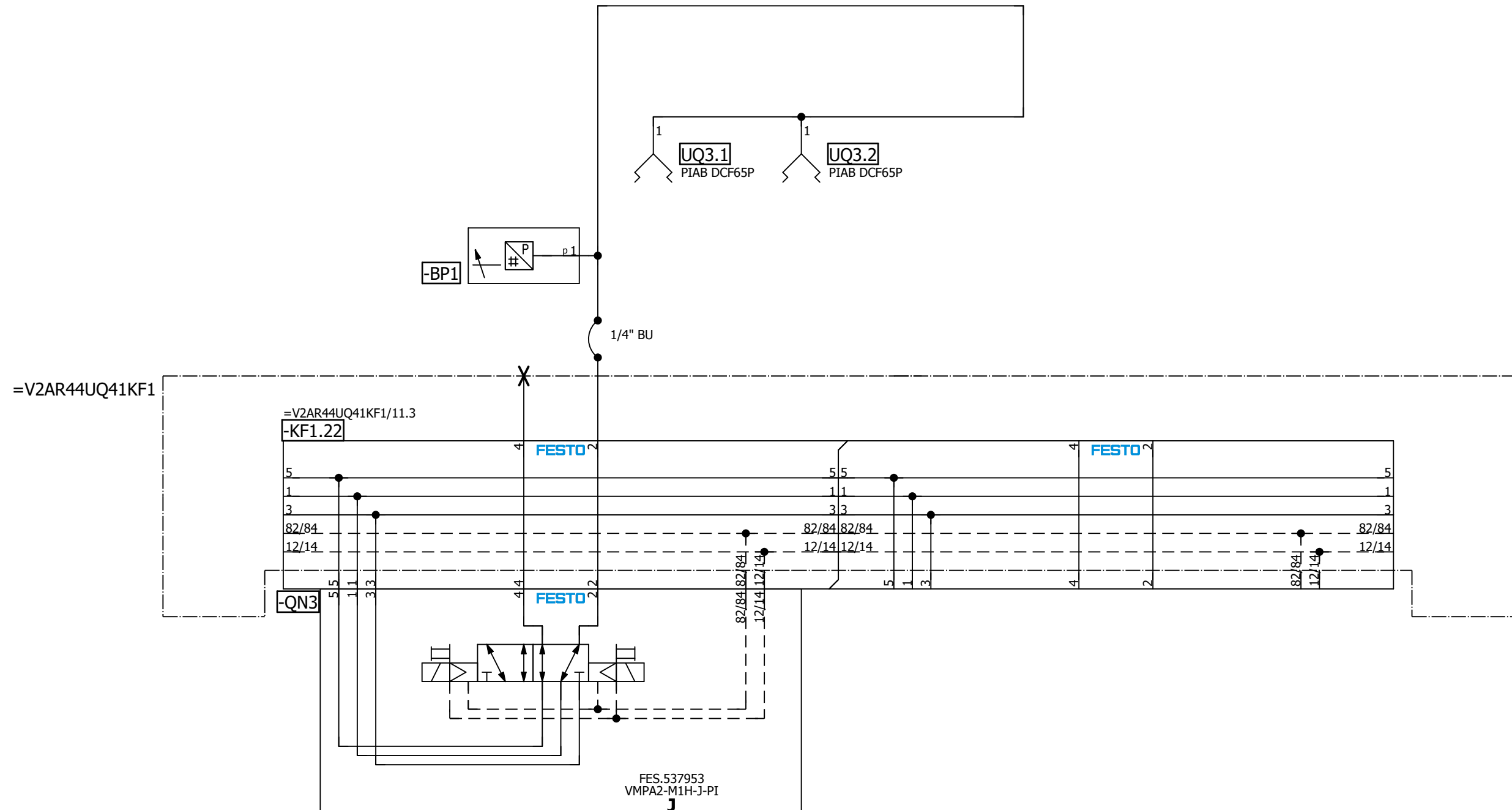

=V2AR44UQ41  
-UQ3-QN3.1  
L150 Model  
Vacuums (RST)

=V2AR44UQ41  
-UQ3-QN3.2  
L150 Model  
Vacuums (SET)

=V2AR44UQ41UQ2/1

=V2AR44UQ41UQ4/1

Date		12/20/2022		Volvo Trucks North America		Valiant TMS		L150 Model Vacuums		Drawing name:		= V2AR44UQ41UQ3	
Ed.		MKLEPADLO		P6700 Framing - Cell 2V01, KF1		Scale 1:1				Document type:		= 2V01&MFS-PNEU_KF1	
Appr.				Replacement of		Replaced by				Project nr:		+ V2AR44UQ41	
Modification		Date		Name		Original				MFS		Page 1	
										22-16152		275	



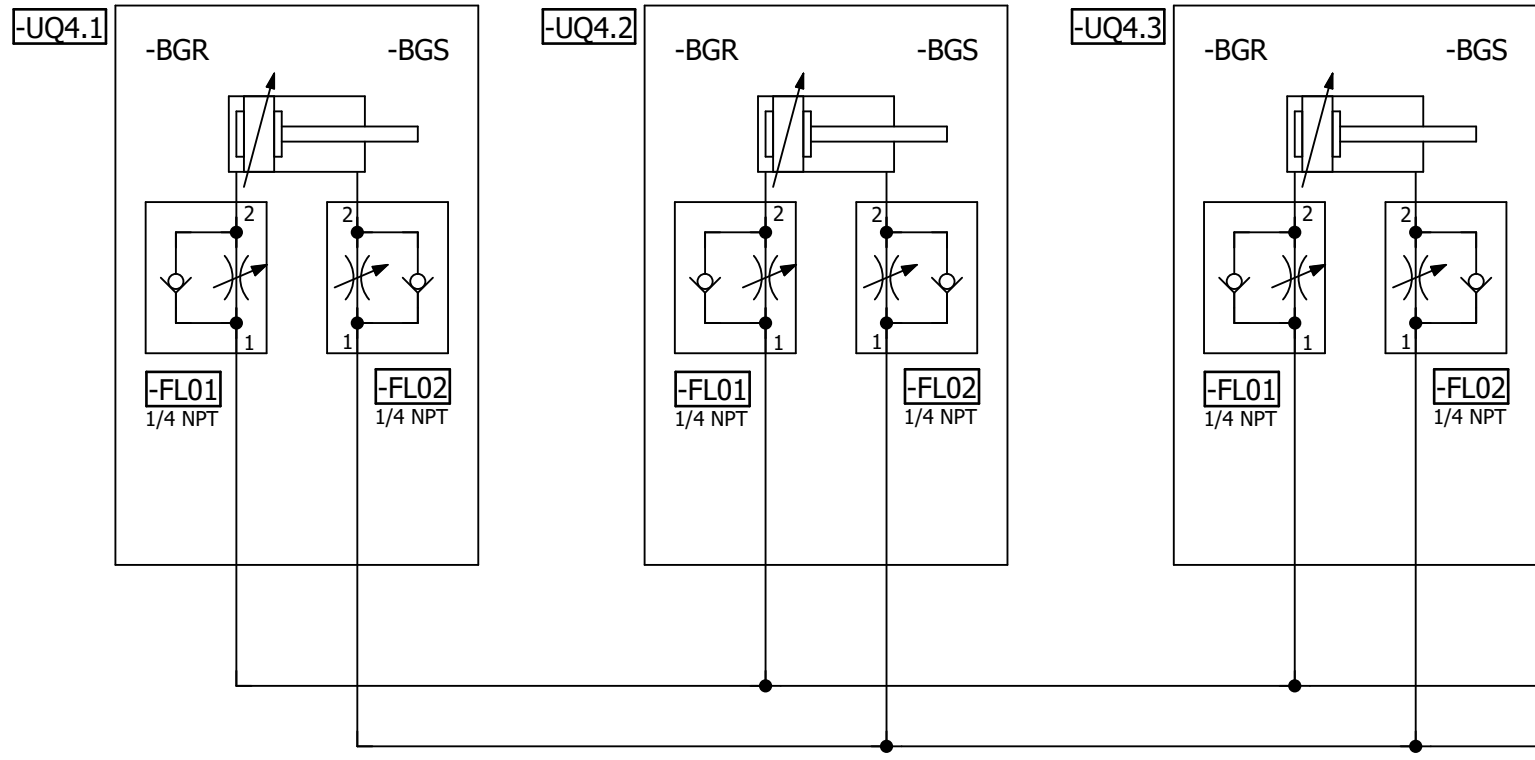

=V2AR44UQ41KF1

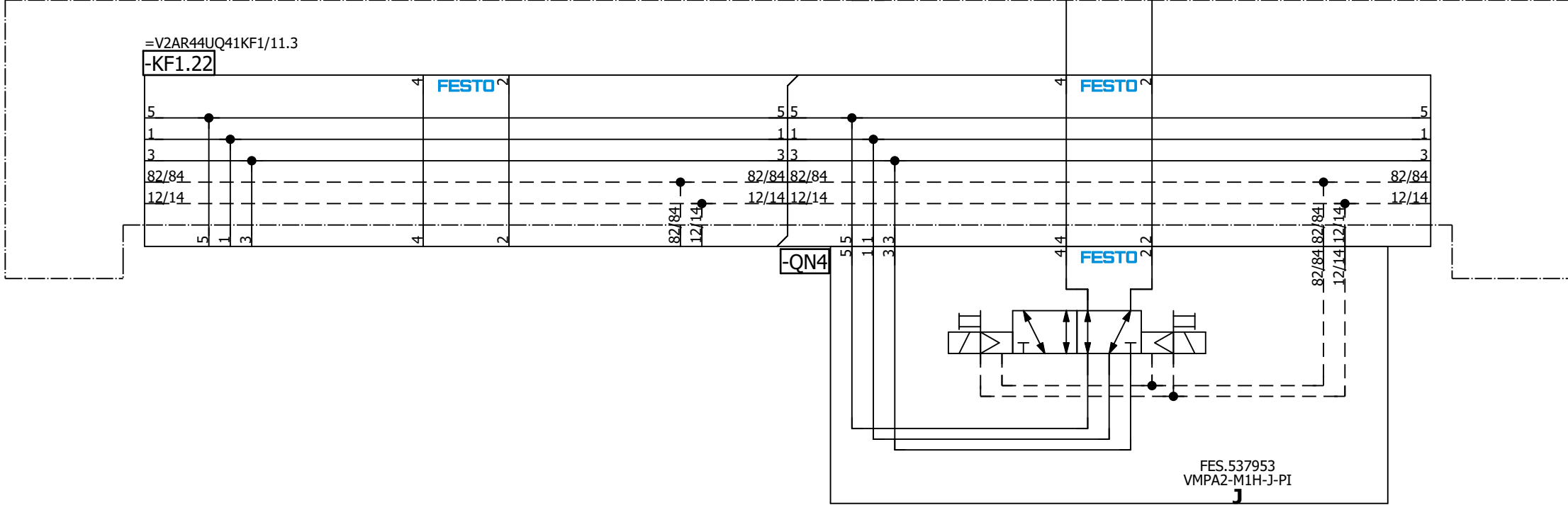

=V2AR44UQ41  
-UQ4-QN4.1  
L150 Model  
Clamps 2 (RST)

=V2AR44UQ41  
-UQ4-QN4.2  
L150 Model  
Clamps 2 (SET)

=V2AR44UQ42KF1+.AR44UQ42/1

=V2AR44UQ41UQ3/1

Date		1/17/2023	Volvo Trucks North America		Valiant TMS		L150 Model Clamps 2		Drawing name:		= V2AR44UQ41UQ4	
Ed.		MKLEPADLO	P6700 Framing - Cell 2V01, KF1		Scale 1:1				Document type:		= V2AR44UQ41	
Appr.			Replacement of		Replaced by				Project nr:		Page	
Original									22-16152		1	
Modification		Date	Name		Original				MFS		275	

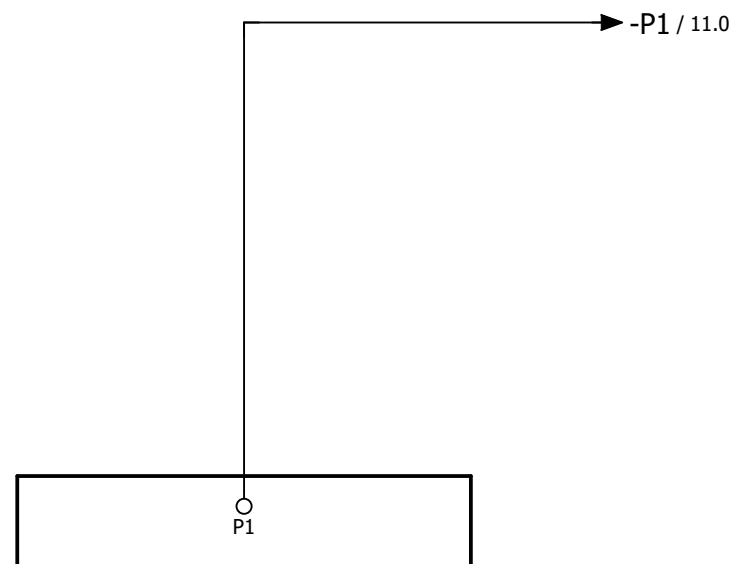

=V2AR44UQ41UQ4+.AR44UQ41/1

		Date	1/3/2023	Volvo Trucks North America			Valiant TMS	AIR SUPPLY GRIPPER	Drawing name:		= V2AR44UQ42KF1
		Ed.	MKLEPADLO	P6700 Framing - Cell 2V01, KF1					=2V01&MFS-PNEU_KF1		+ V2AR44UQ42
Modification	Date	Name	Original	Replacement of	Replaced by		Scale 1:1		Document type:	Project nr:	Page
									MFS	22-16152	1
											275



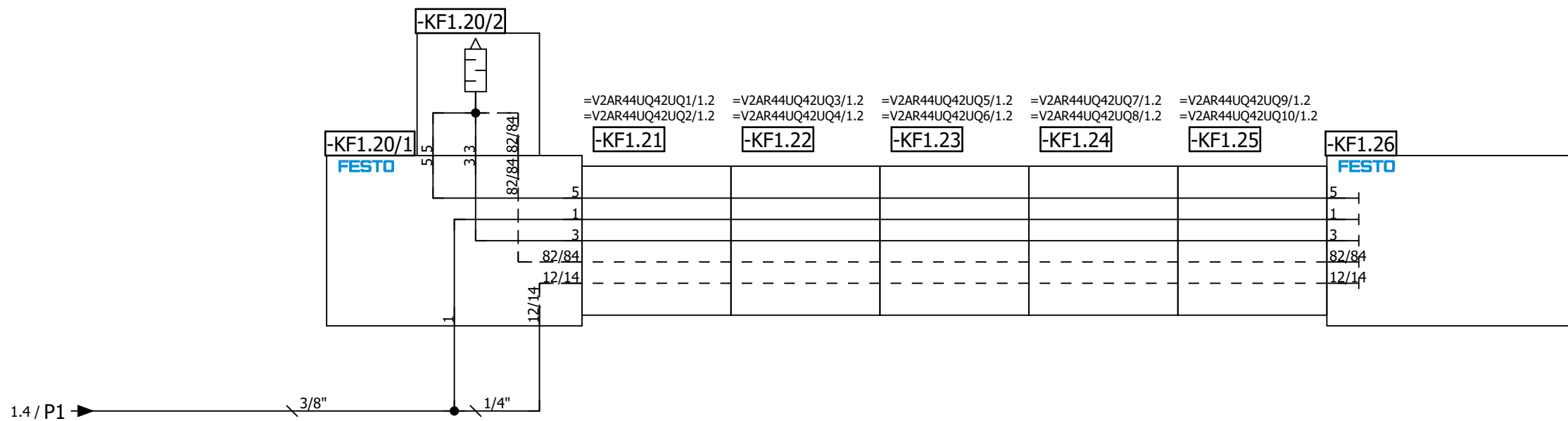
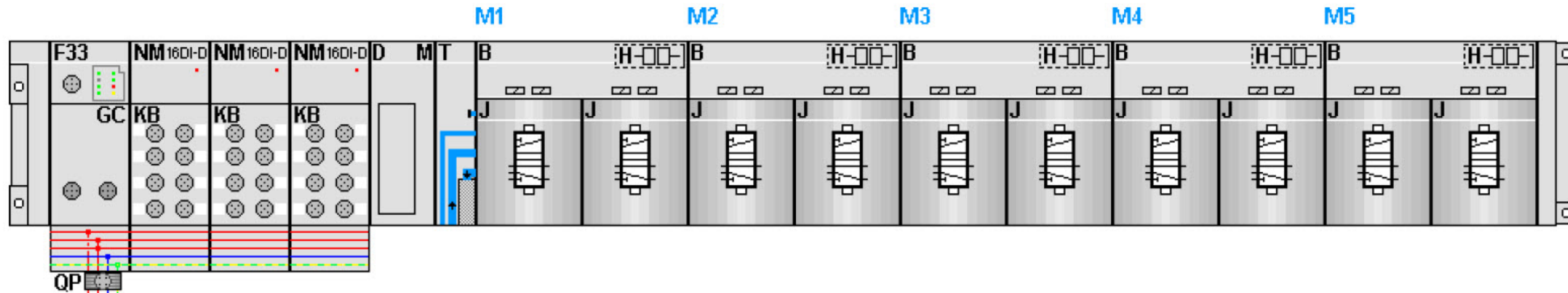







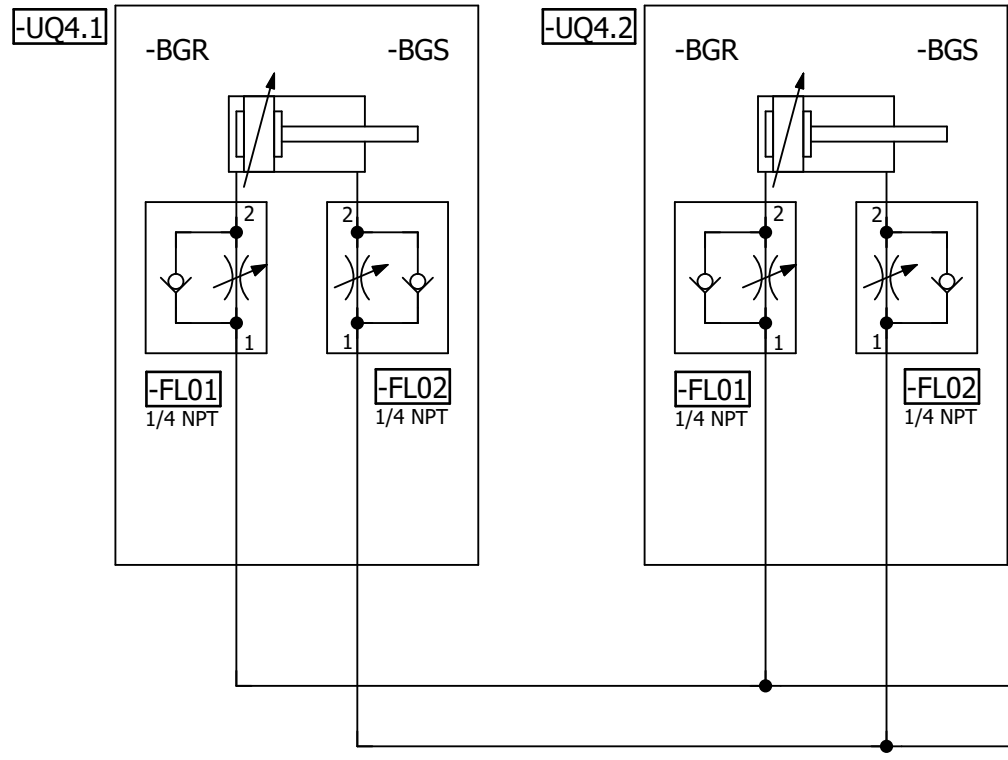

=V2AR44UQ42KF1

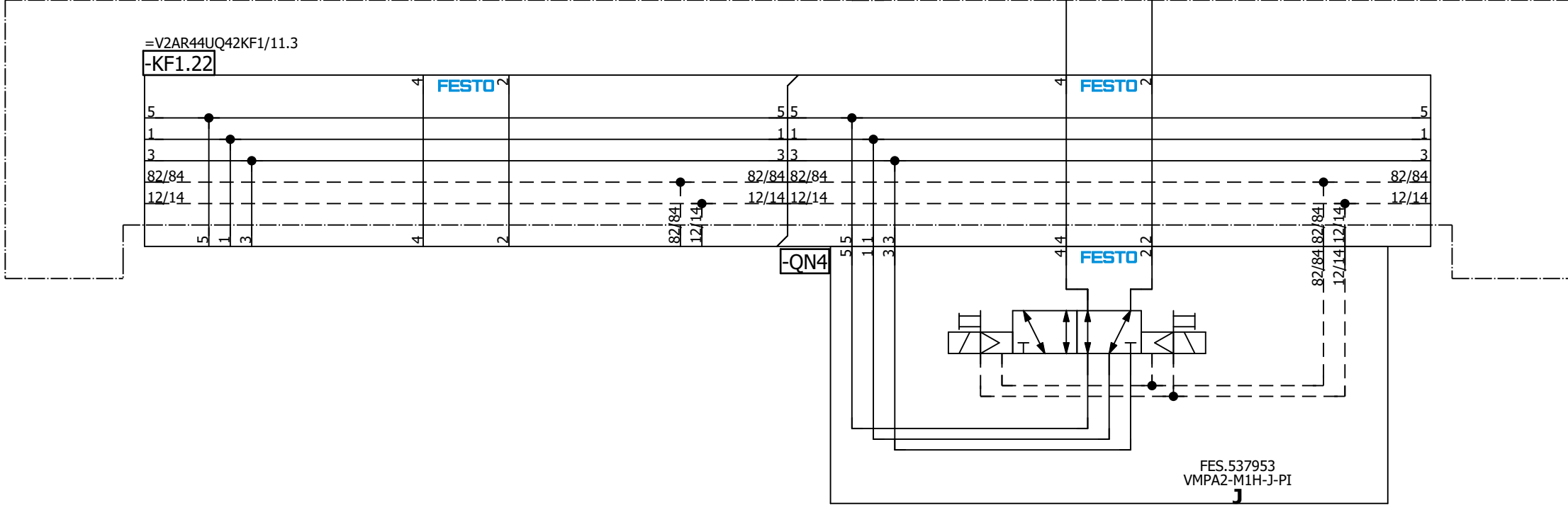

=V2AR44UQ42  
-UQ4-QN4.1  
L290/320 Model  
Clamps 1 (RST)

=V2AR44UQ42  
-UQ4-QN4.2  
L290/320 Model  
Clamps 1 (SET)

=V2AR44UQ42UQ3/1

=V2AR44UQ42UQ5/1

Date: 1/17/2023		Volvo Trucks North America		Valiant TMS		L290/320 Model Clamps 1		Drawing name: =2V01&MFS-PNEU_KF1		= V2AR44UQ42UQ4	
Ed.: MKLEPADLO		P6700 Framing - Cell 2V01, KF1		Scale 1:1				Document type: MFS		+ V2AR44UQ42	
Appr:		Replacement of		Replaced by				Project nr: 22-16152		Page 1	
Original										275	



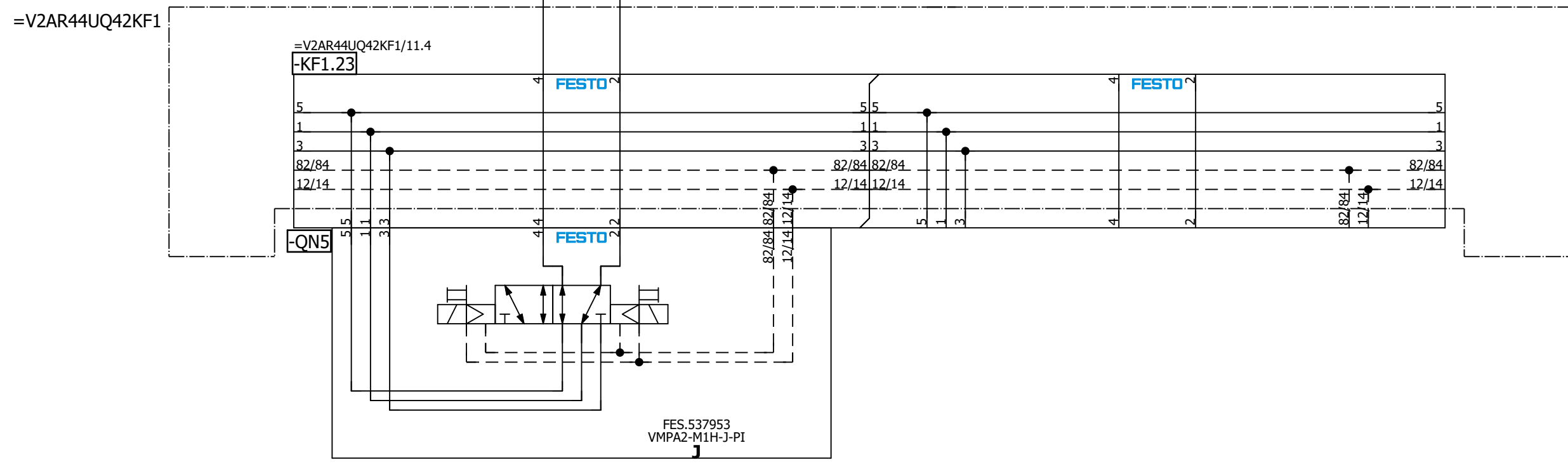
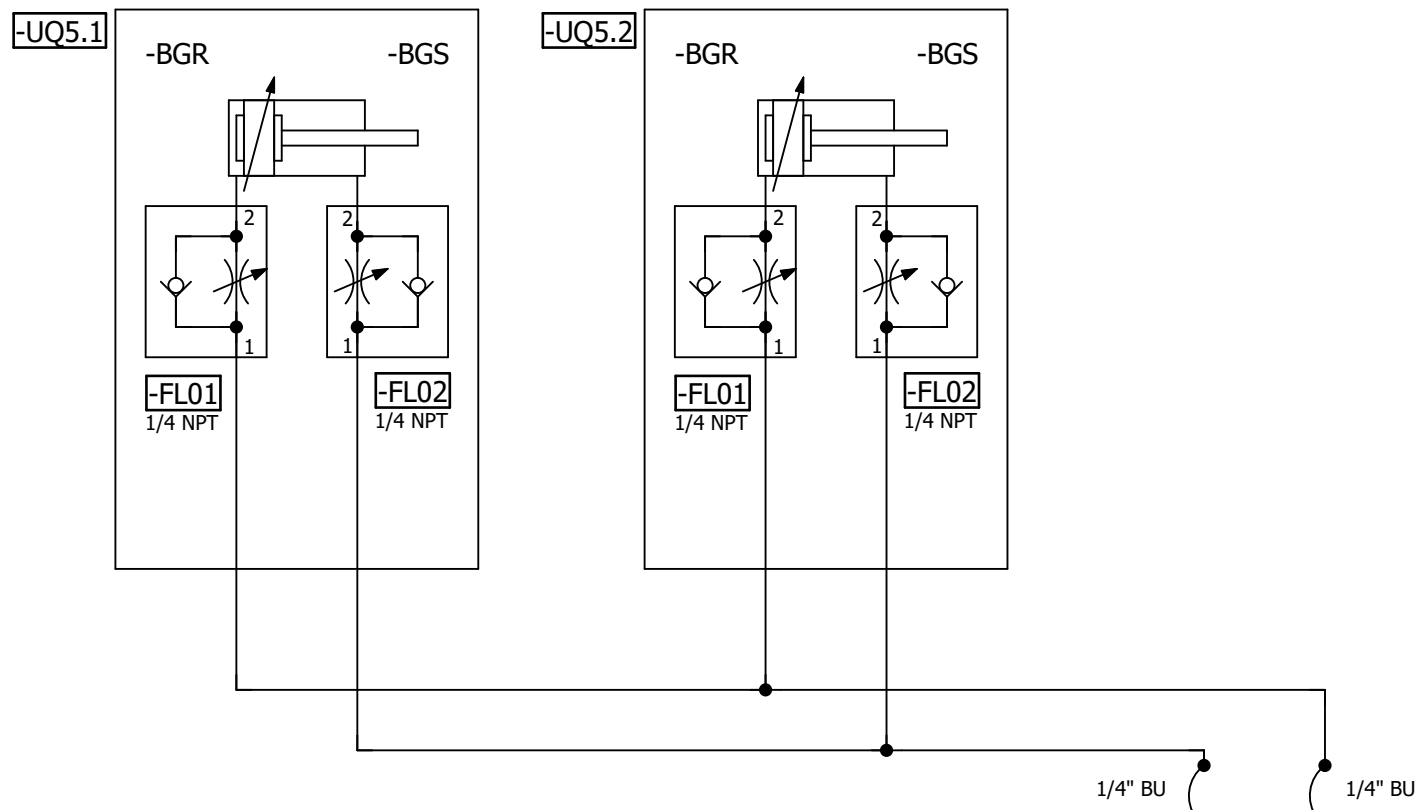

=V2AR44UQ42  
-UQ5-QN5.1  
L290 Model  
Clamps 2 (RST)

=V2AR44UQ42  
-UQ5-QN5.2  
L290 Model  
Clamps 2 (SET)

=V2AR44UQ42UQ4/1

=V2AR44UQ42UQ6/1

Date: 1/17/2023		Volvo Trucks North America		Valiant TMS		Drawing name: =2V01&MFS-PNEU_KF1		= V2AR44UQ42UQ5	
Ed.: MKLEPADLO		P6700 Framing - Cell 2V01, KF1		L290 Model Clamps 2		Document type: MFS		+ V2AR44UQ42	
Appr:		Replacement of		Replaced by		Project nr: 22-16152		Page 1	
Original								275	

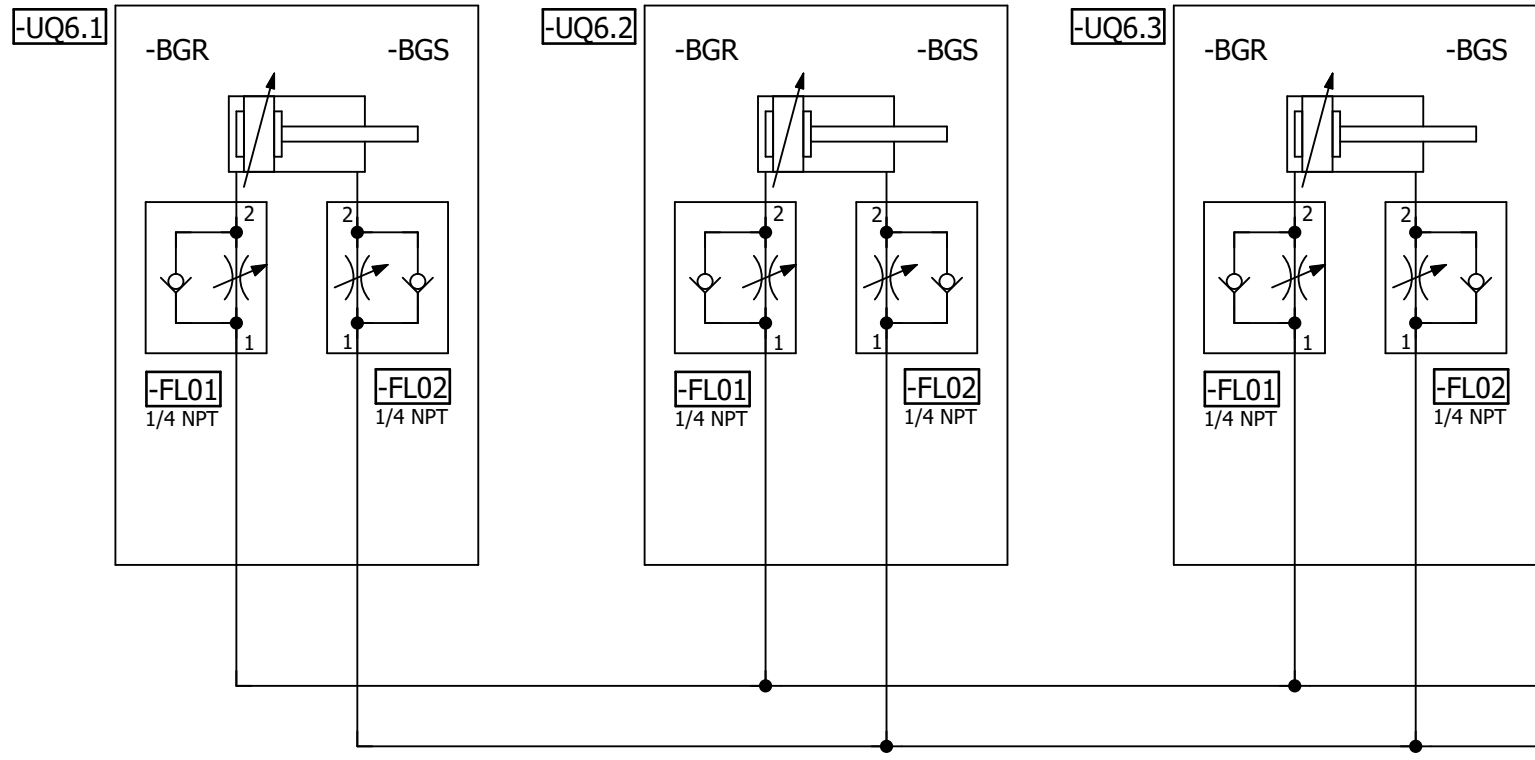

=V2AR44UQ42KF1

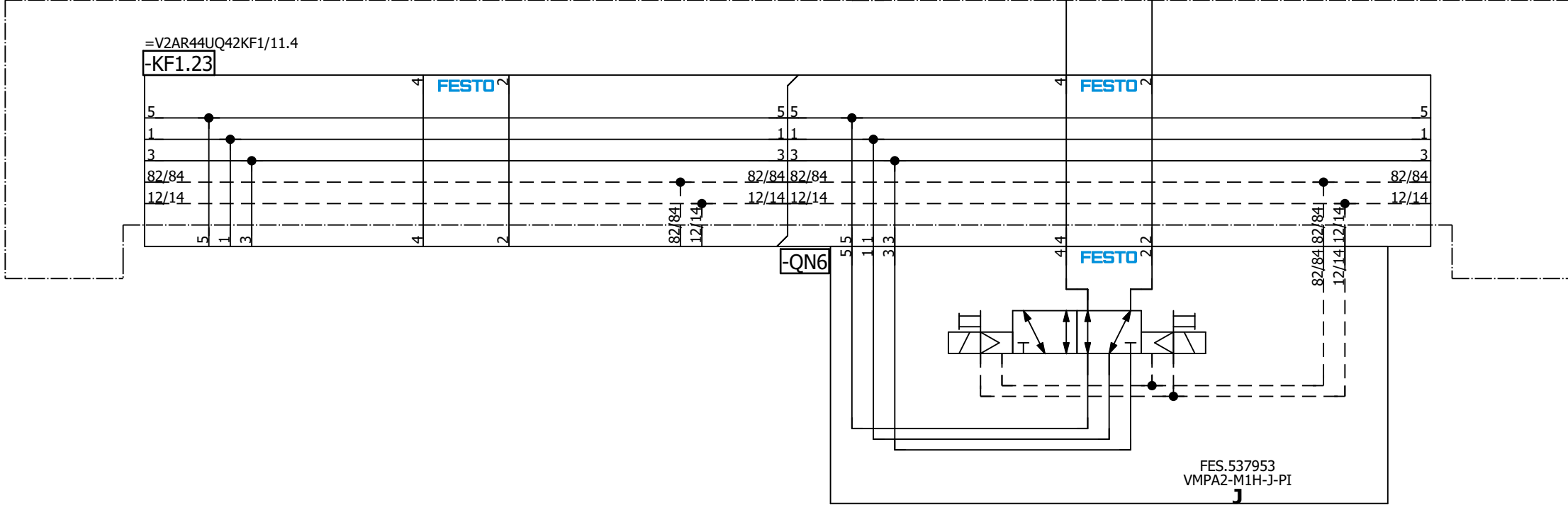

=V2AR44UQ42  
-UQ6-QN6.1  
L290/320 Model  
Clamps 2 (RST)

=V2AR44UQ42  
-UQ6-QN6.2  
L290/320 Model  
Clamps 2 (SET)

=V2AR44UQ42UQ7/1

=V2AR44UQ42UQ5/1		Date	1/17/2023	Volvo Trucks North America	Valiant TMS	L290/320 Model Clamps 2	Drawing name:	= V2AR44UQ42UQ6	
		Ed.	MKLEPADLO				=2V01&MFS-PNEU_KF1	+ V2AR44UQ42	
		Appr		P6700 Framing - Cell 2V01, KF1	Scale 1:1		Document type:	Project nr:	
Modification	Date	Name	Original	Replacement of	Replaced by		MFS	22-16152	
								Page	1
									275

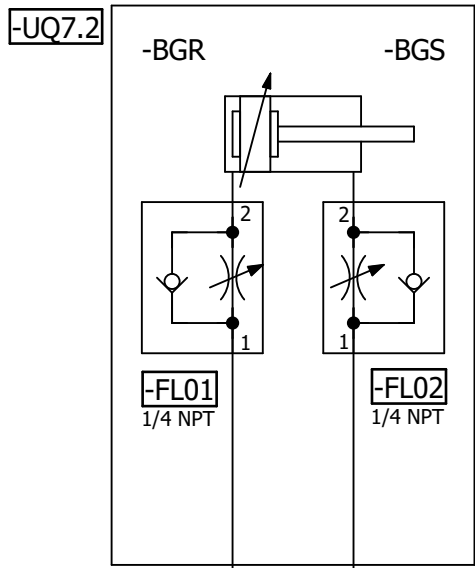
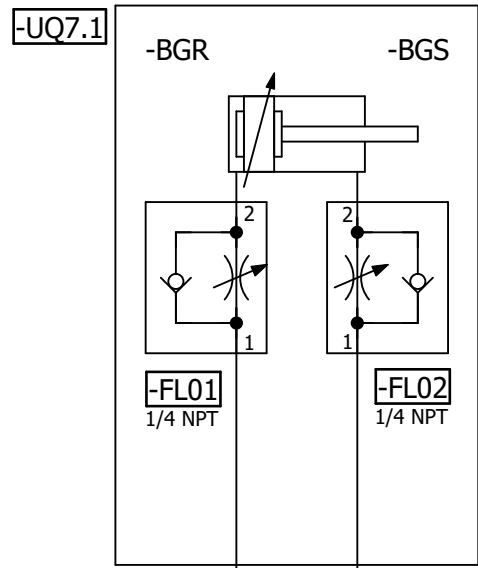

=V2AR44UQ42KF1

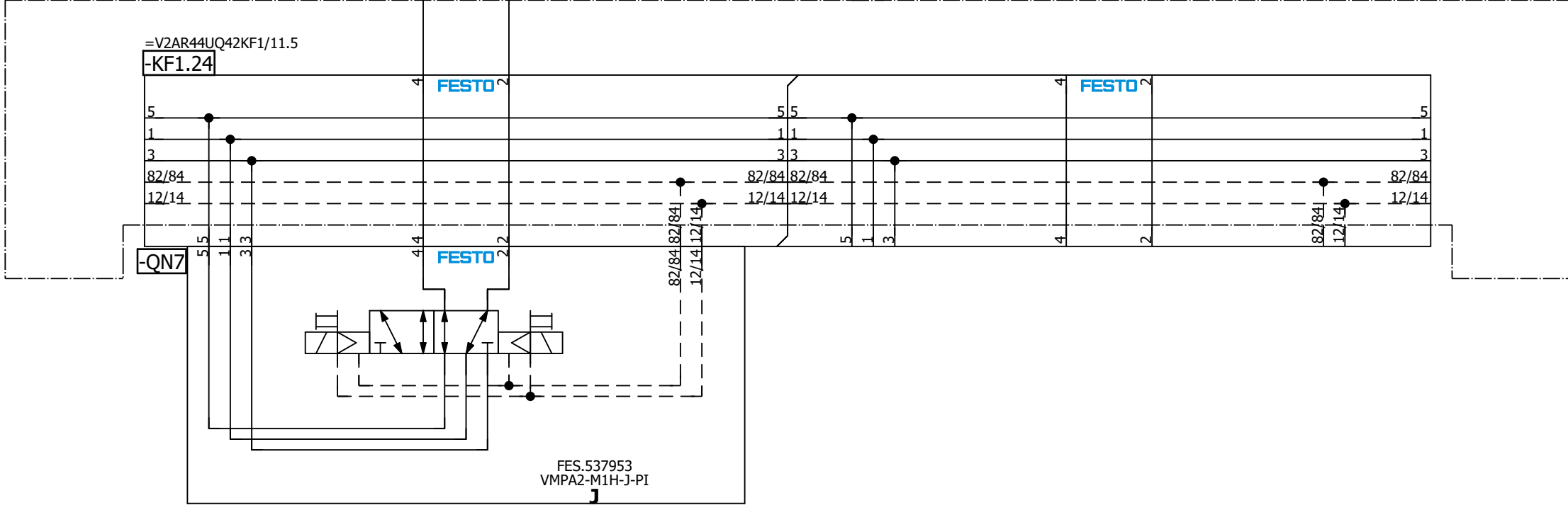

=V2AR44UQ42  
-UQ7-QN7.1  
L290 Model  
Clamps 3 (RST)

=V2AR44UQ42  
-UQ7-QN7.2  
L290 Model  
Clamps 3 (SET)

=V2AR44UQ42UQ6/1

=V2AR44UQ42UQ8/1

Date: 1/17/2023		Volvo Trucks North America		Valiant TMS		Drawing name: =V2AR44UQ42UQ7		= V2AR44UQ42UQ7	
Ed.: MKLEPADLO		P6700 Framing - Cell 2V01, KF1		L290 Model Clamps 3		Document type: MFS		+ V2AR44UQ42	
Appr:		Replacement of		Scale 1:1		Project nr: 22-16152		Page 1	
Original		Replaced by						275	

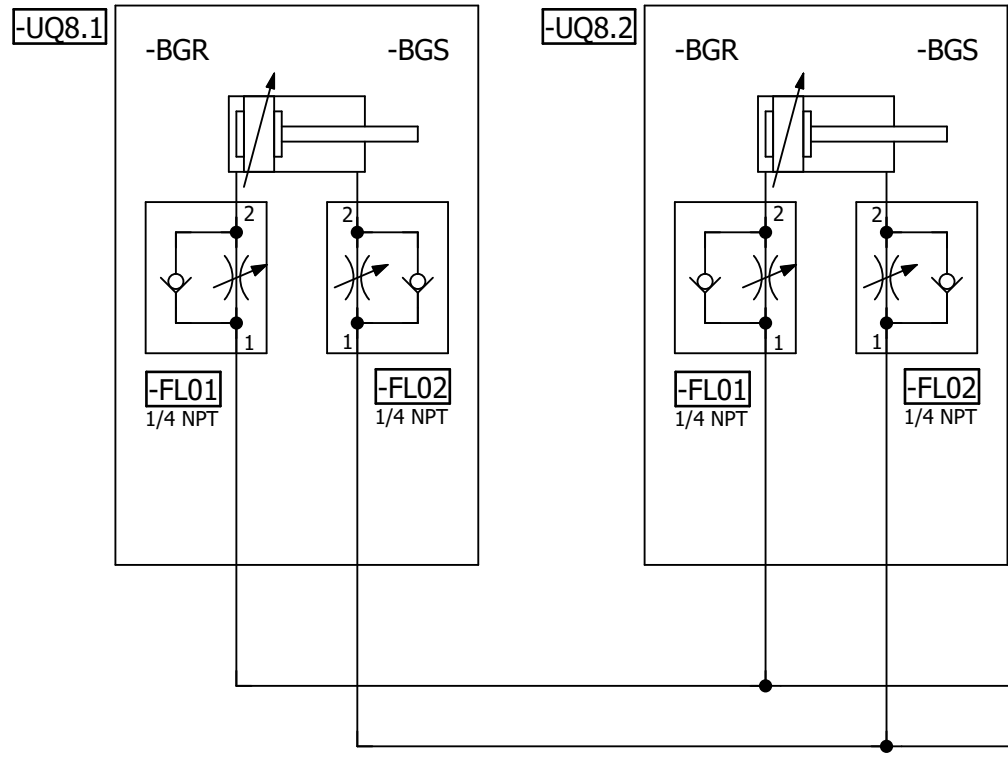

=V2AR44UQ42KF1

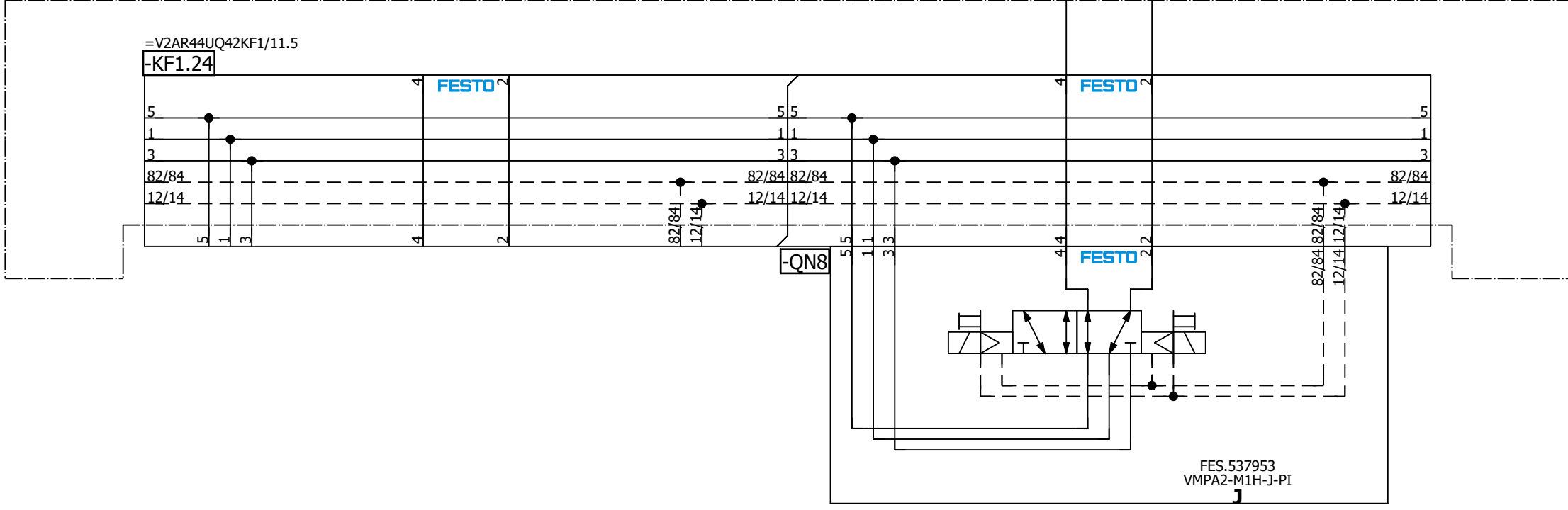

=V2AR44UQ42  
-UQ8-QN8.1  
L320 Model  
Clamps 1 (RST)

=V2AR44UQ42  
-UQ8-QN8.2  
L320 Model  
Clamps 1 (SET)

=V2AR44UQ42UQ7/1

=V2AR44UQ42UQ9/1

			Date	1/17/2023	Volvo Trucks North America		Valiant TMS	L320 Model Clamps 1	Drawing name:	= V2AR44UQ42UQ8
			Ed.	MKLEPADLO	P6700 Framing - Cell 2V01, KF1				=2V01&MFS-PNEU_KF1	+ V2AR44UQ42
Modification	Date	Name	Appr	Original	Replacement of	Replaced by	Scale 1:1		Document type:	Project nr:
									MFS	22-16152
									Page	1
										275

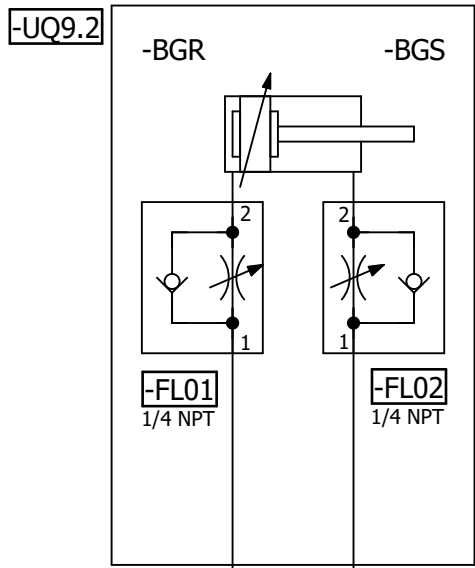
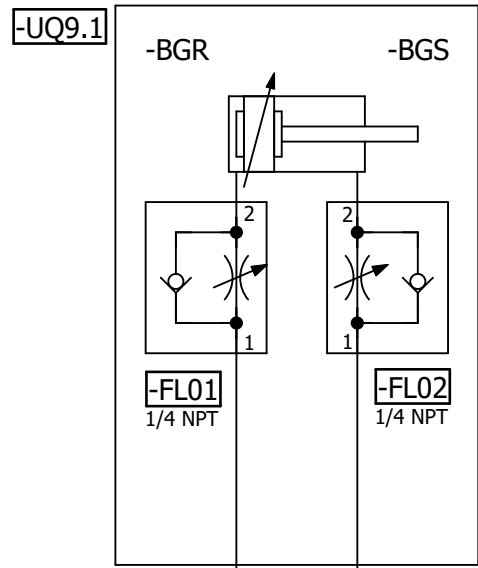

=V2AR44UQ42KF1

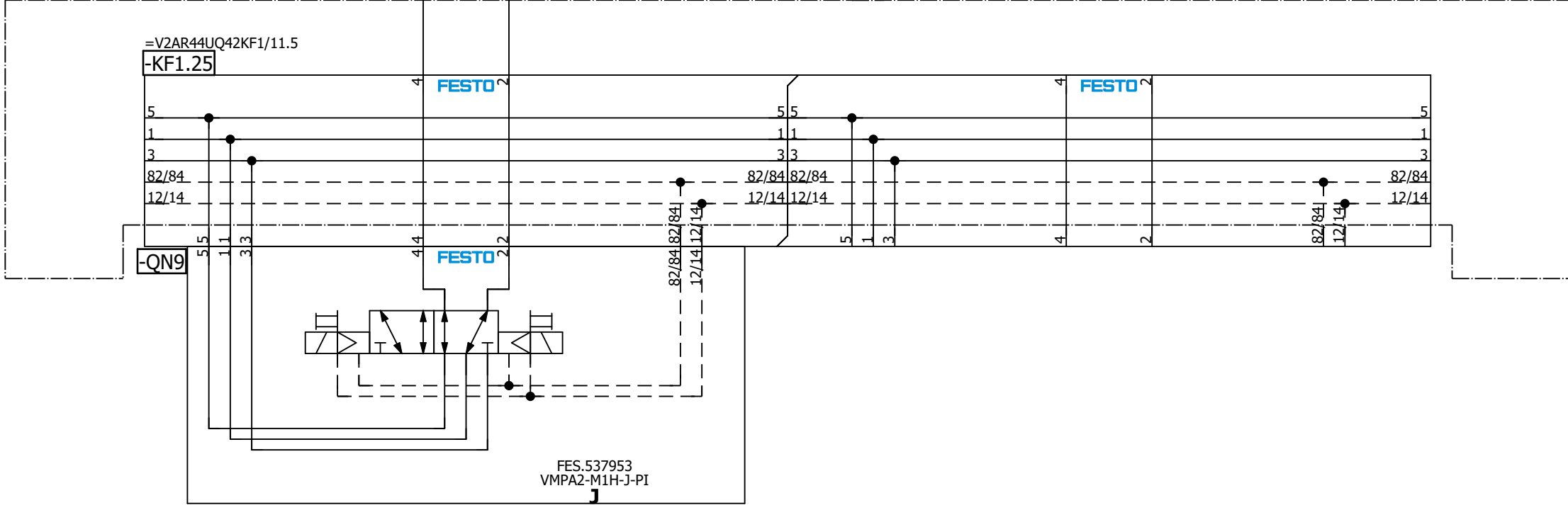

=V2AR44UQ42  
-UQ9-QN9.1  
L320 Model  
Clamps 2 (RST)

=V2AR44UQ42  
-UQ9-QN9.2  
L320 Model  
Clamps 2 (SET)

=V2AR44UQ42UQ8/1

=V2AR44UQ42UQ10/1

		Date	1/17/2023	Volvo Trucks North America		Valiant TMS		L320 Model Clamps 2		Drawing name: =2V01&MFS-PNEU_KF1		= V2AR44UQ42UQ9 + V2AR44UQ42	
		Ed.	MKLEPADLO	P6700 Framing - Cell 2V01, KF1		Scale 1:1				Document type: MFS		Project nr: 22-16152	
Modification	Date	Name	Original	Replacement of	Replaced by							Page	1
													275

=V2AR44UQ42KF1

=V2AR44UQ42KF1/11.5  
-KF1.25

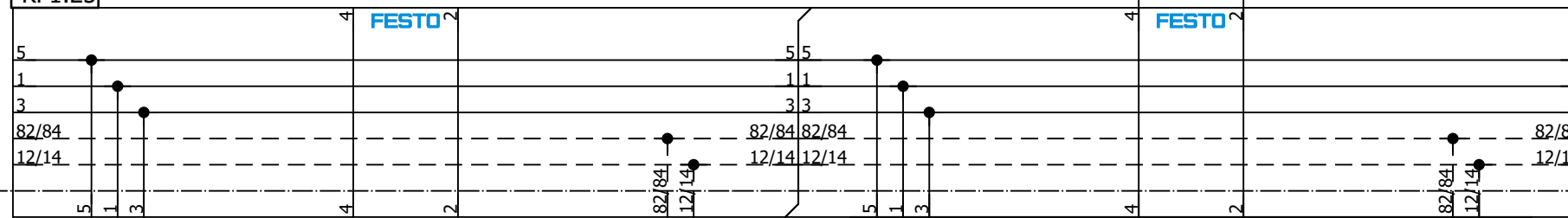

-QN10

FES.537953  
VMPA2-M1H-J-PI

=V2AR44UQ42  
-UQ10-QN10.1  
Spare  
(RST)

=V2AR44UQ42  
-UQ10-QN10.2  
Spare  
(SET)

=V2AR44UQ43KF1+.AR44UQ43/1

=V2AR44UQ42UQ9/1

Date		12/20/2022		Volvo Trucks North America		Valiant TMS		Spare		Drawing name:		= V2AR44UQ42UQ10	
Ed.		MKLEPADLO		P6700 Framing - Cell 2V01, KF1		Scale 1:1				Document type:		= V2AR44UQ42	
Appr.				Replacement of		Replaced by				Project nr:		Page	
Original										22-16152		1	
Modification		Date		Name		Original				MFS		275	

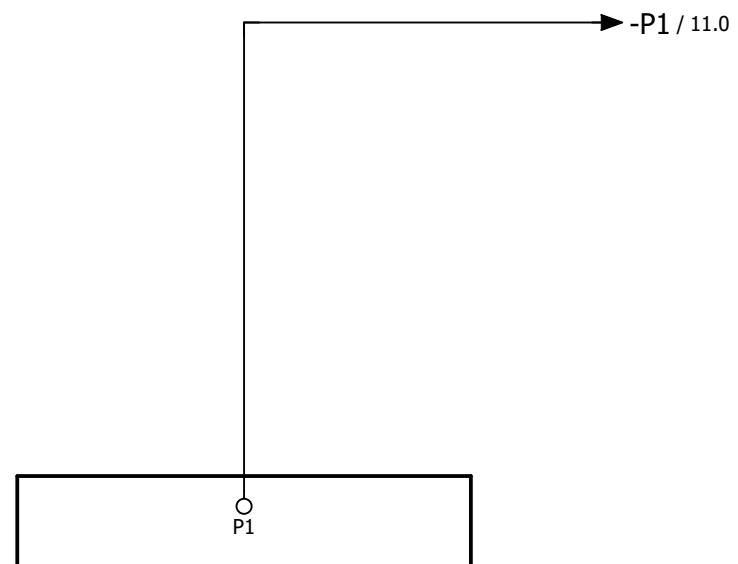

=V2AR44UQ42UQ10+.AR44UQ42/1

		Date	1/3/2023	Volvo Trucks North America			Valiant TMS	AIR SUPPLY GRIPPER	Drawing name:		= V2AR44UQ43KF1
		Ed.	MKLEPADLO	P6700 Framing - Cell 2V01, KF1					=2V01&MFS-PNEU_KF1		+ V2AR44UQ43
		Appr		Replacement of		Replaced by	Scale 1:1		Document type:	Project nr:	Page
Modification	Date	Name	Original						MFS	22-16152	1
											275





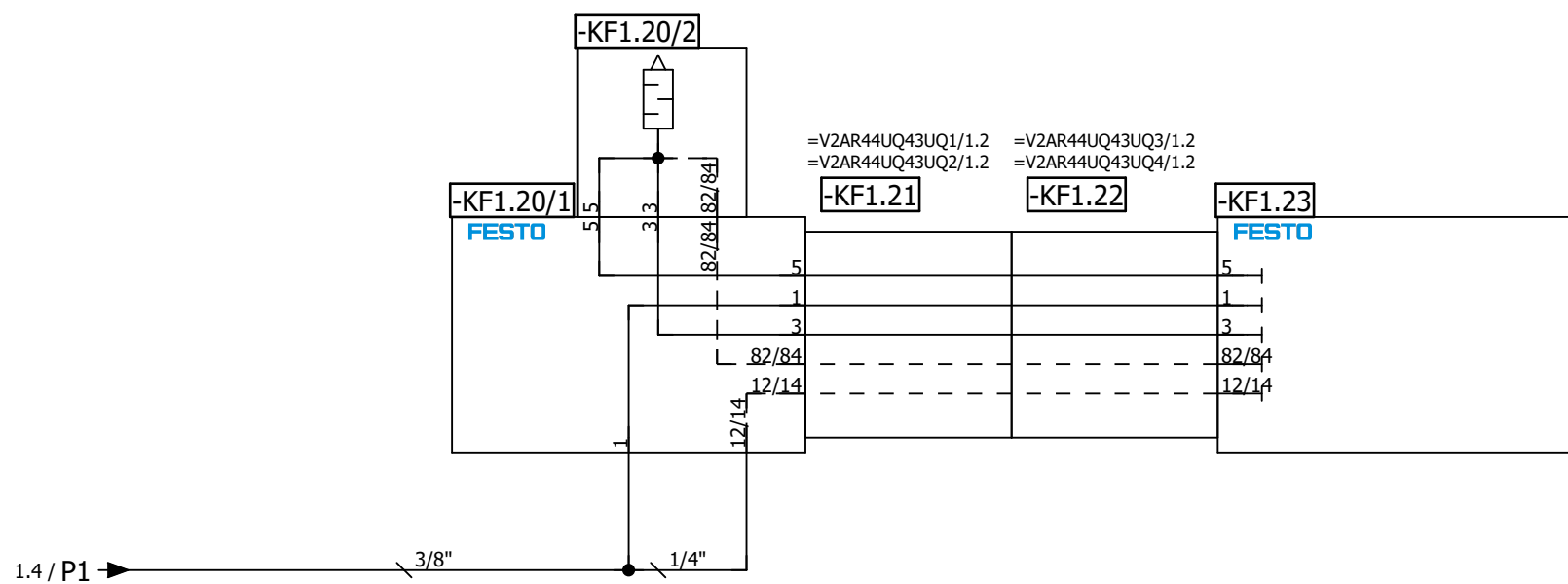
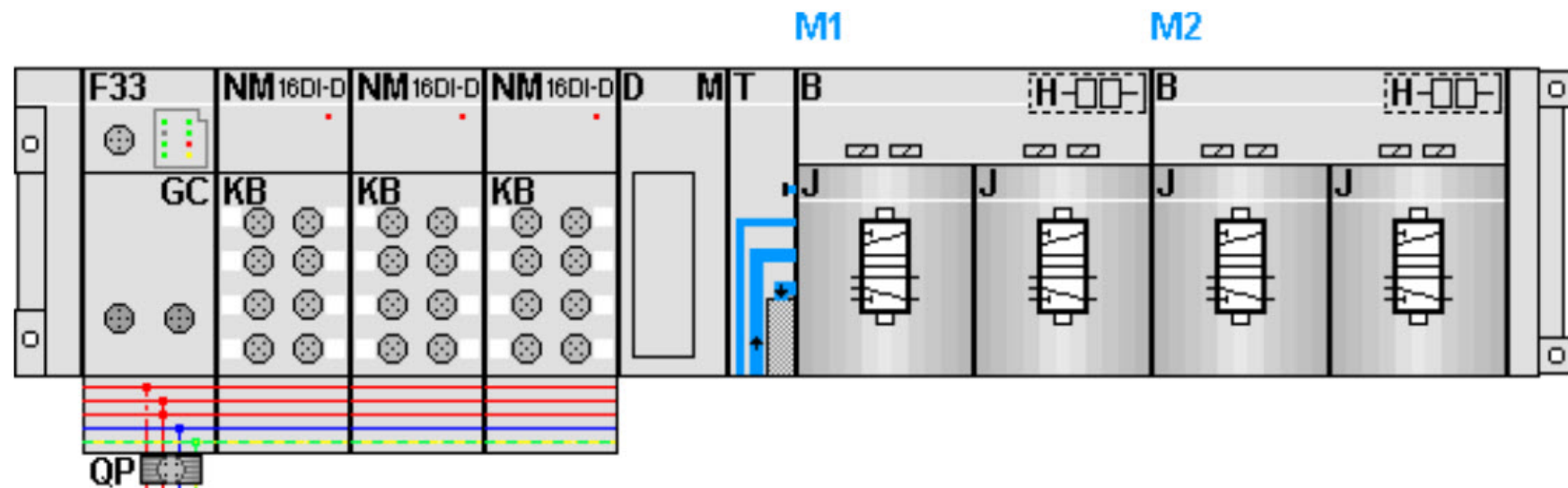

Date		1/17/2023	Volvo Trucks North America		Valiant TMS	AIR SUPPLY	Drawing name:		= V2AR44UQ43KF1				
Ed.		MKLEPADLO	P6700 Framing - Cell 2V01, KF1				=2V01&MFS-PNEU_KF1		+ V2AR44UQ43				
Appr			Replacement of		Scale 1:1	Document type:		MFS	Project nr:		22-16152	Page	11
Original			Replaced by			MFS		22-16152				275	





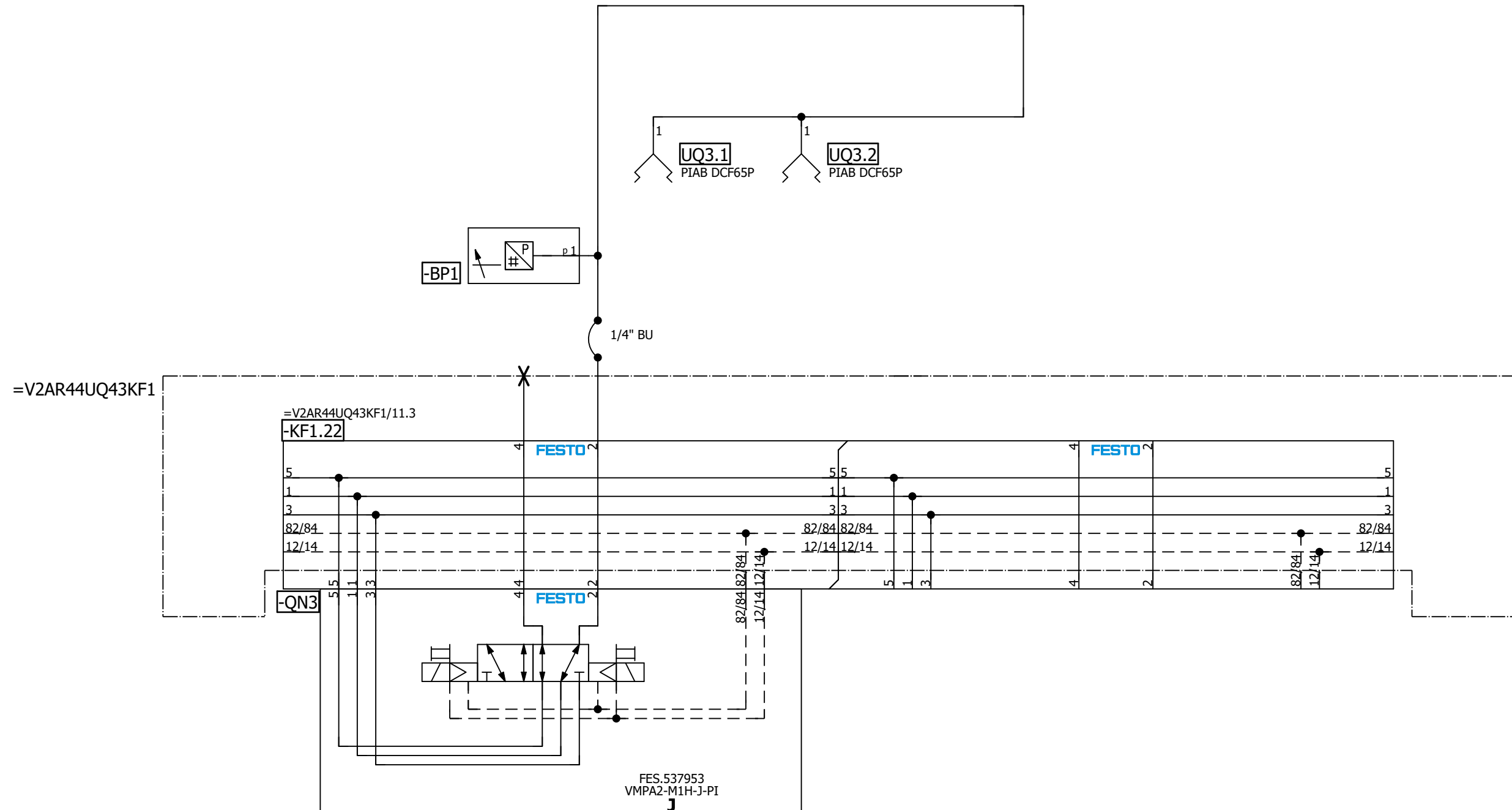

=V2AR44UQ43  
-UQ3-QN3.1  
L230 Model  
Vacuums (RST)

=V2AR44UQ43  
-UQ3-QN3.2  
L230 Model  
Vacuums (SET)

=V2AR44UQ43UQ2/1

=V2AR44UQ43UQ4/1

Date		12/20/2022		Volvo Trucks North America		Valiant TMS		L230 Model Vacuums		Drawing name:		= V2AR44UQ43UQ3	
Ed.		MKLEPADLO		P6700 Framing - Cell 2V01, KF1		Scale 1:1				Document type:		= V2AR44UQ43	
Appr.				Replacement of		Replaced by				Project nr:		Page	
Original										MFS		275	
Modification		Date		Name		Original				22-16152		1	

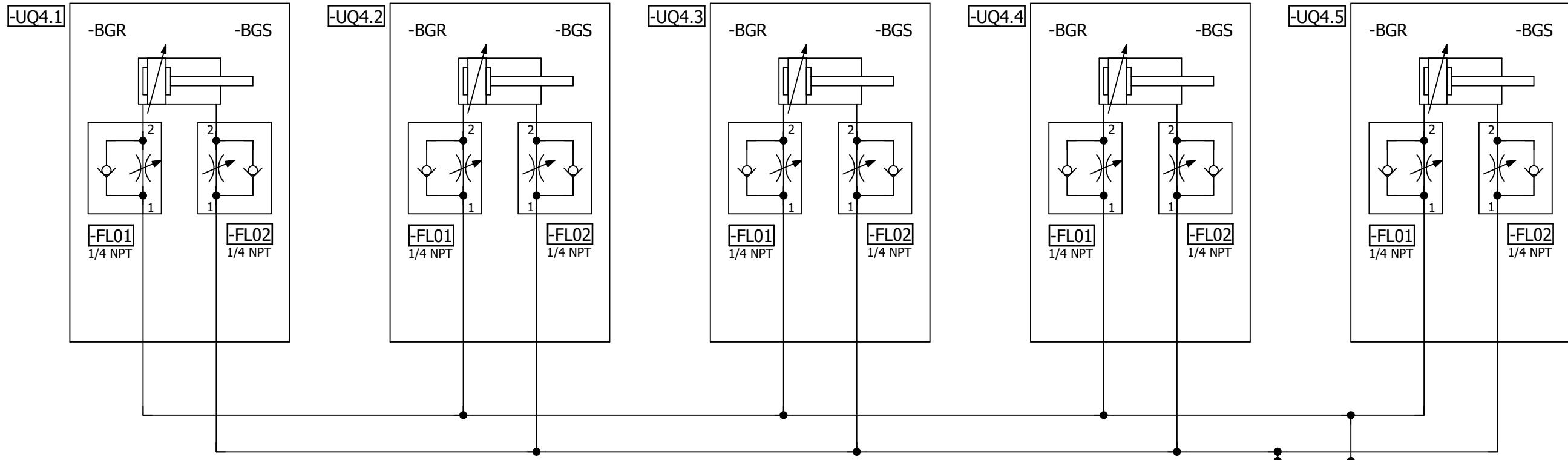

=V2AR44UQ43KF1

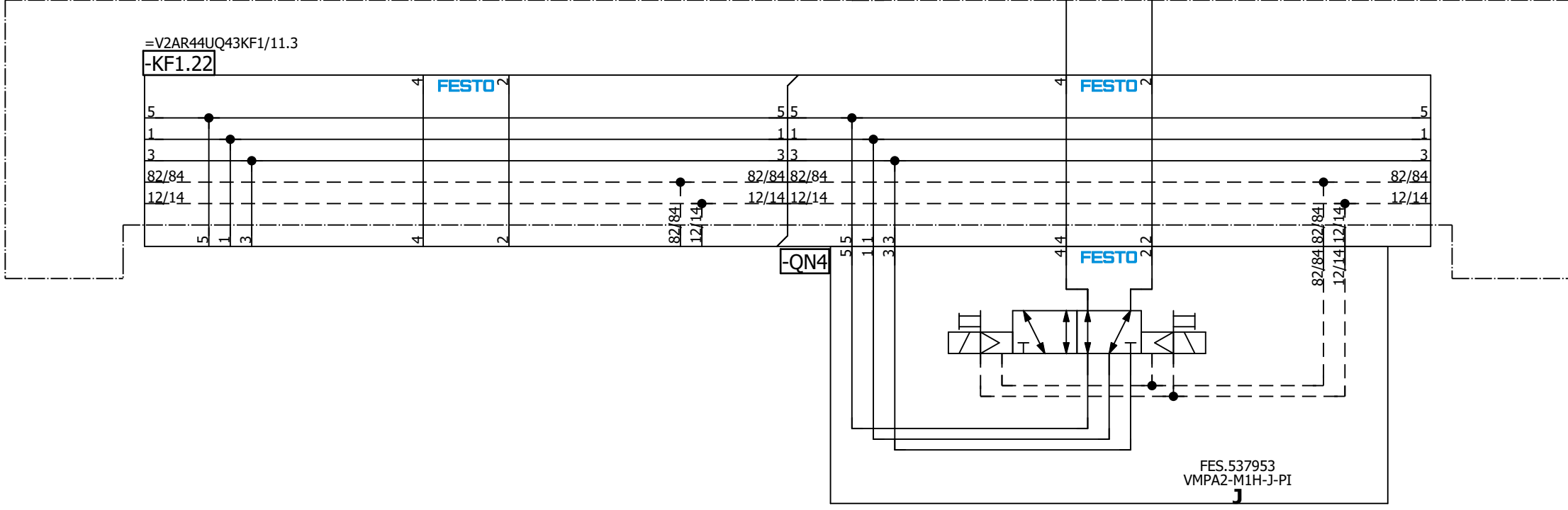

=V2AR44UQ43  
-UQ4-QN4.1  
L230 Model  
Clamps 2 (RST)

=V2AR44UQ43  
-UQ4-QN4.2  
L230 Model  
Clamps 2 (SET)

=V2GL15+KH1/1

=V2AR44UQ43UQ3/1			Date	1/17/2023	Volvo Trucks North America	Valiant TMS	L230 Model Clamps 2	Drawing name:	=V2V01&MFS-PNEU_KF1	= V2AR44UQ43UQ4
			Ed.	MKLEPADLO		Scale 1:1		Document type:	MFS	+ V2AR44UQ43
			Appr		P6700 Framing - Cell 2V01, KF1			Project nr:	22-16152	Page
Modification	Date	Name	Original		Replacement of	Replaced by				1
										275

A2

=KH0+KH0/1.8 / +V2GL15KH1-P1 →

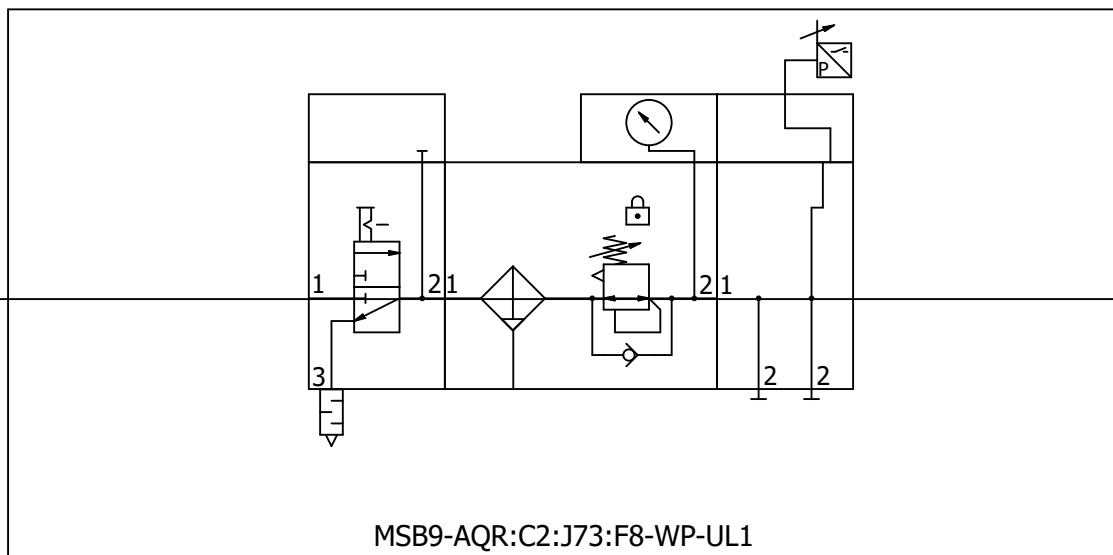

→ +V2GL15UQ51-P1 / =V2GL15UQ51KF2+V2GL15UQ51/11.0

=V2AR44UQ43UQ4+V2AR44UQ43/1

=V2GL15UQ51KF2+V2GL15UQ51/5

			Date	12/20/2022	Volvo Trucks North America	Valiant TMS	Incoming air supply (Conveyor)	Drawing name:		= V2GL15	
			Ed.	MKLEPADLO				=2V01&MFS-PNEU_KF1		+ KH1	
			Appr					P6700 Framing - Cell 2V01, KF1		Document type:	Project nr:
Modification	Date	Name	Original		Replacement of	Replaced by	Scale 1:1	MFS	22-16152	1	
										275	



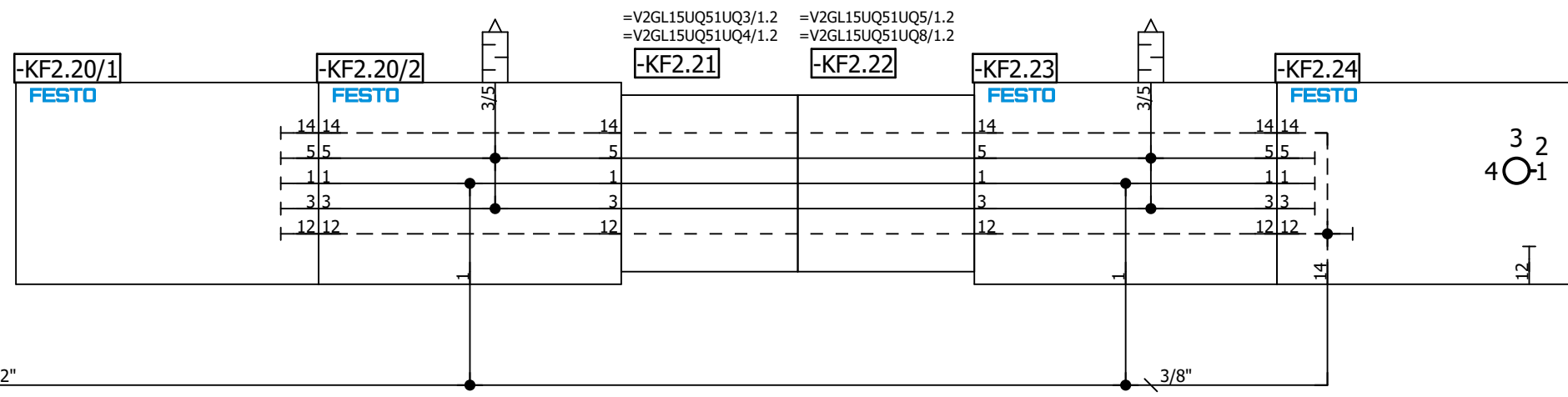
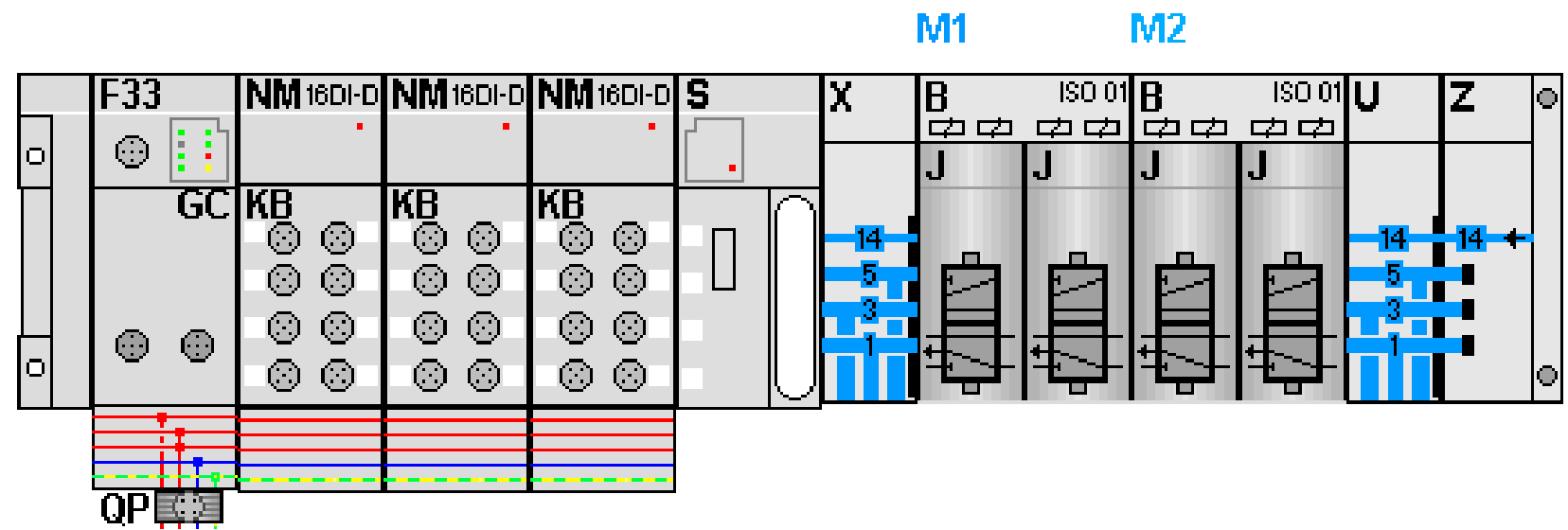

=V2GL15+KH1/1.6 / P1











A2

=KH0+KH0/1.8 / +V2GL16KH1-P1 →

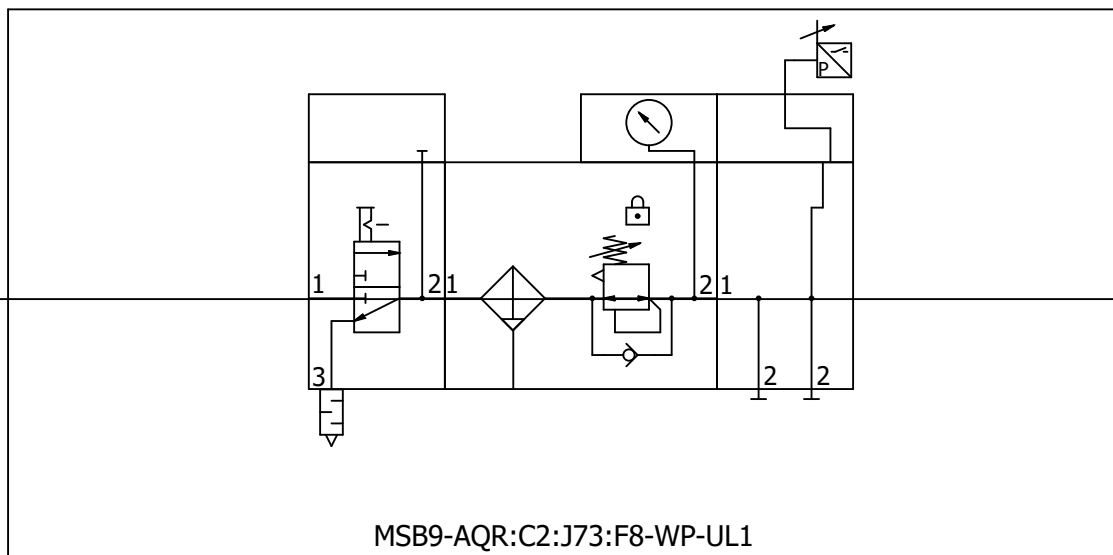

→ +V2GL16UQ51-P1 / =V2GL16UQ51KF2+V2GL16UQ51/11.0

=V2GL15UQ51UQ8+V2GL15UQ51/1

=V2GL16UQ51KF2+V2GL16UQ51/5

			Date	12/20/2022	Volvo Trucks North America	Valiant TMS	Incoming air supply (Conveyor)	Drawing name:		= V2GL16	
			Ed.	MKLEPADLO				=2V01&MFS-PNEU_KF1		+ KH1	
			Appr					Document type:	MFS	Project nr:	22-16152
Modification	Date	Name	Original		Replacement of	Replaced by	Scale 1:1				275









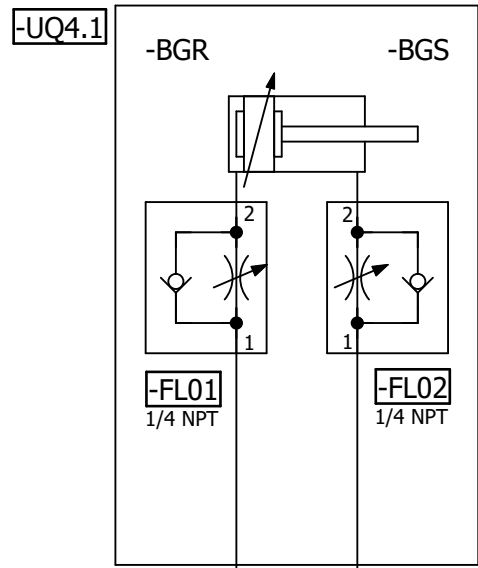

=V2GL16UQ51KF2

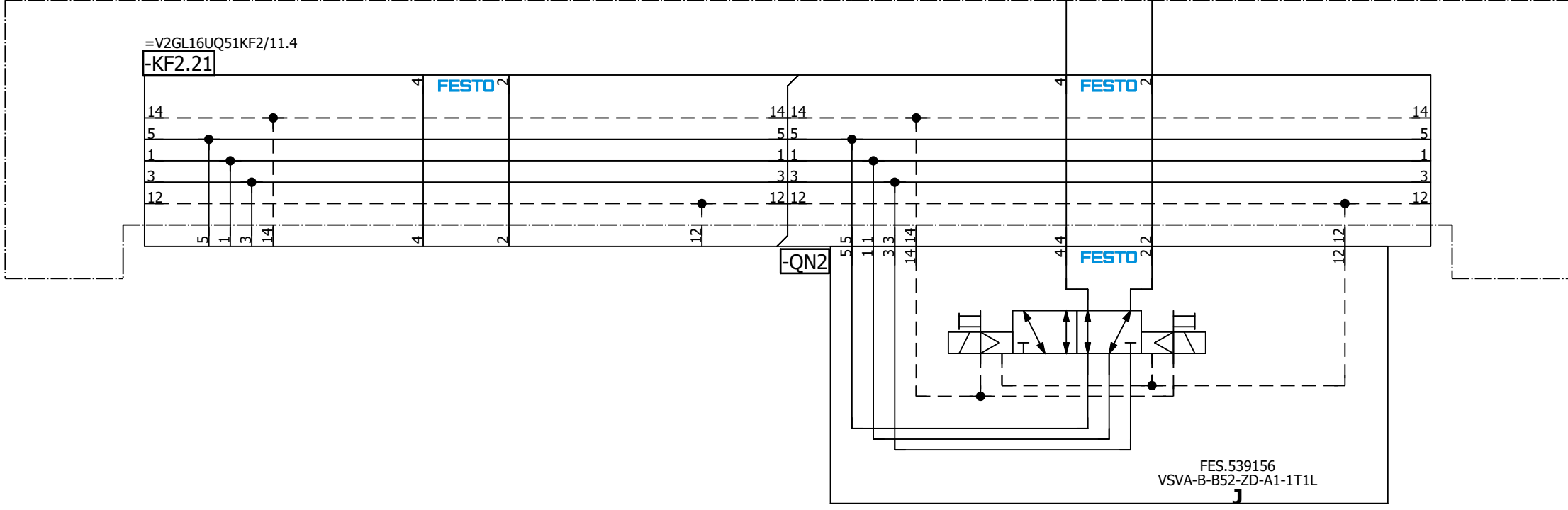

=V2GL16UQ51  
-UQ4-QN2.1  
Pallet Stop Sta #4  
Unload (RST)

=V2GL16UQ51  
-UQ4-QN2.2  
Pallet Stop Sta #4  
Unload (SET)

=V2GL16UQ51UQ5/1

=V2GL16UQ51UQ3/1

Date		12/20/2022		Volvo Trucks North America		Valiant TMS		Pallet Stop Station #4 Unload		Drawing name:		= V2GL16UQ51UQ4	
Ed.		MKLEPADLO		P6700 Framing - Cell 2V01, KF1		Scale 1:1				Document type:		+ V2GL16UQ51	
Appr				Replacement of		Replaced by				Project nr:		Page	
Original										22-16152		1	
Modification		Date		Name		Original				MFS		275	



=V2GL16UQ51KF2

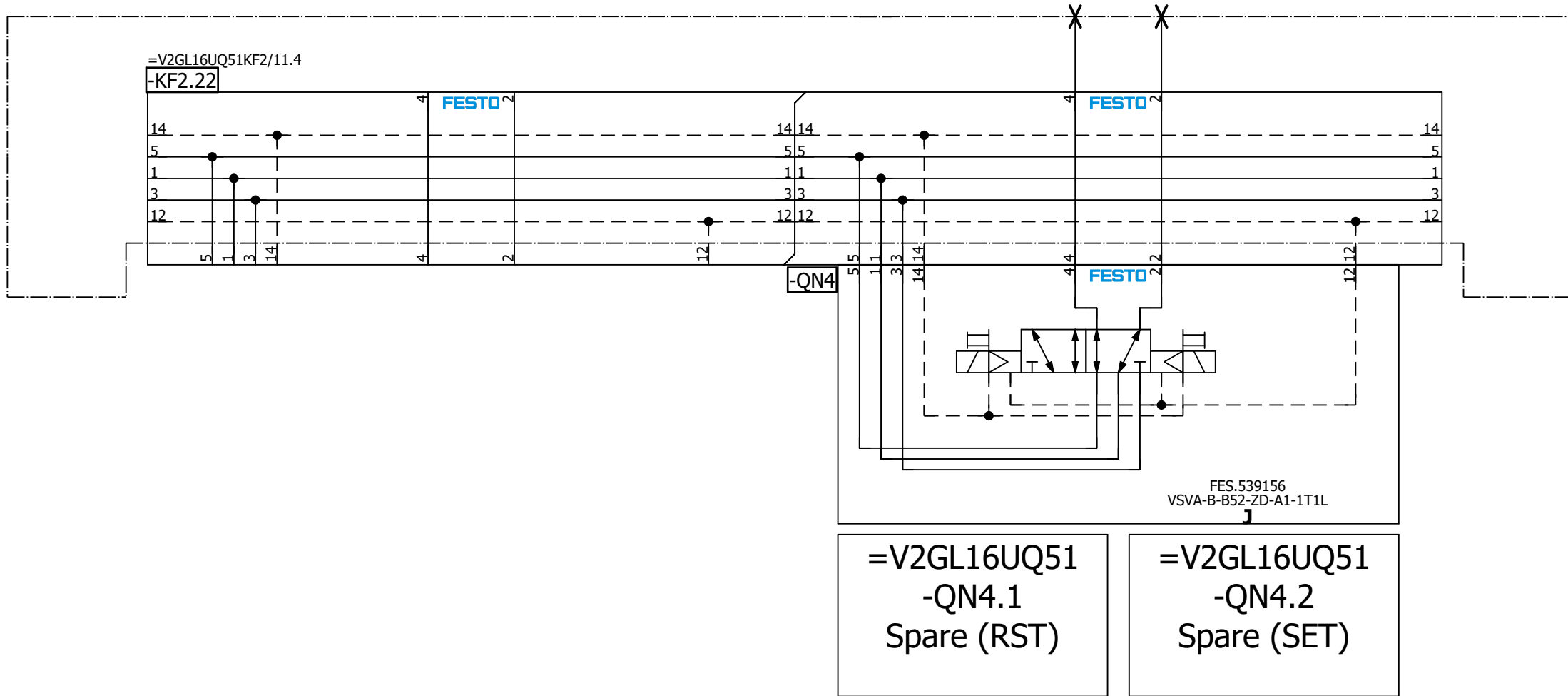

=V2GL16UQ51UQ5/1 =V2GL17+KH1/1

Modification		Date	Name	Original	Replacement of	Replaced by	Scale 1:1	Drawing name: =V2V01&MFS-PNEU_KF1		= V2GL16UQ51UQ8 + V2GL16UQ51		Page 1
		Date	Name	Original	Replacement of	Replaced by	Scale 1:1	Document type: MFS		Project nr: 22-16152		Page 275
				Volvo Trucks North America		Valiant TMS		Spare QN4				
				P6700 Framing - Cell 2V01, KF1								







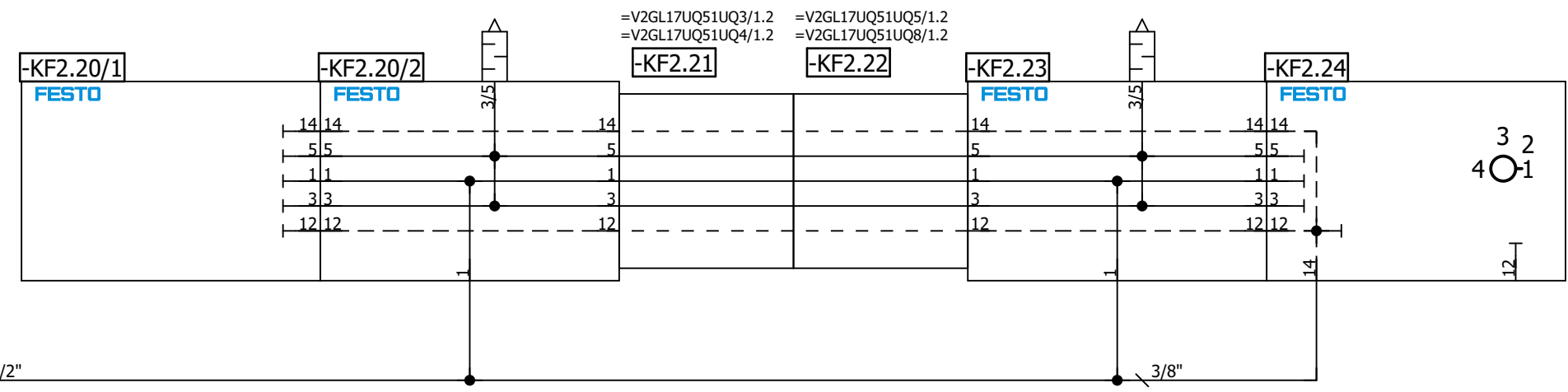
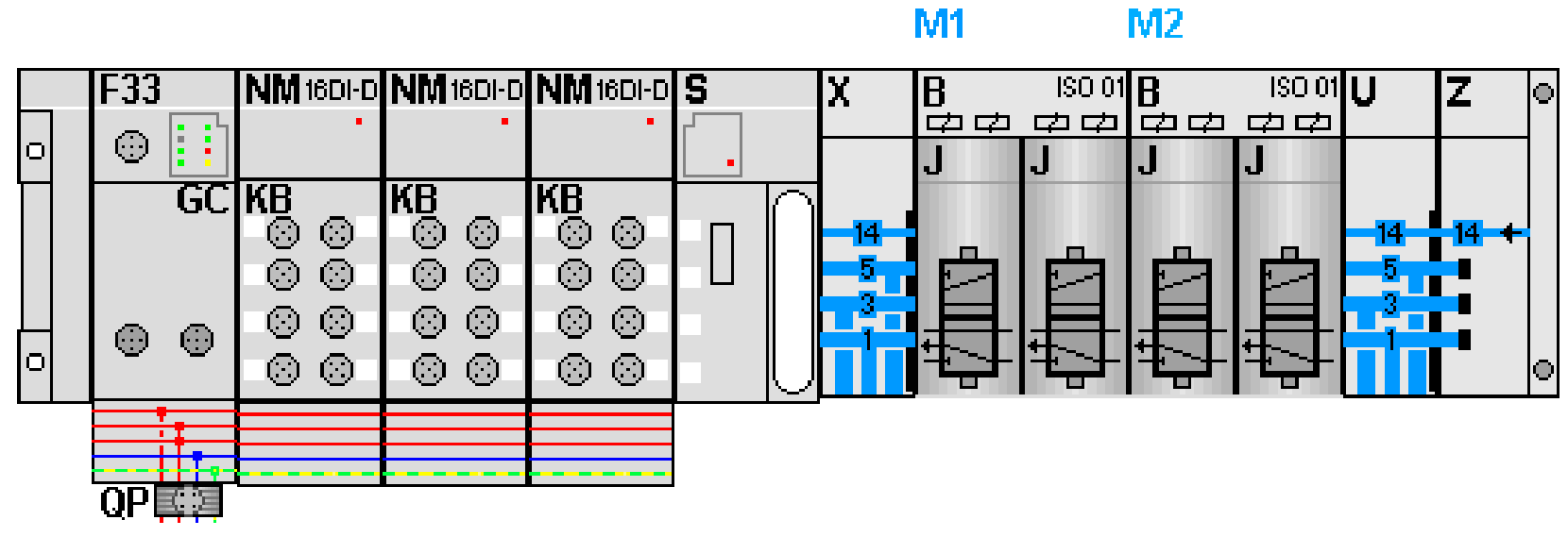







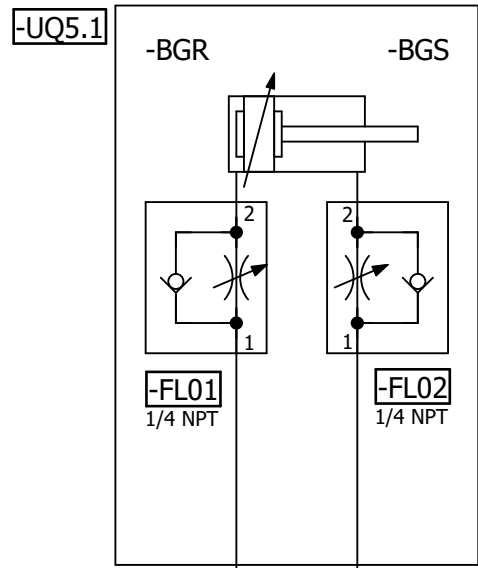

=V2GL17UQ51KF2

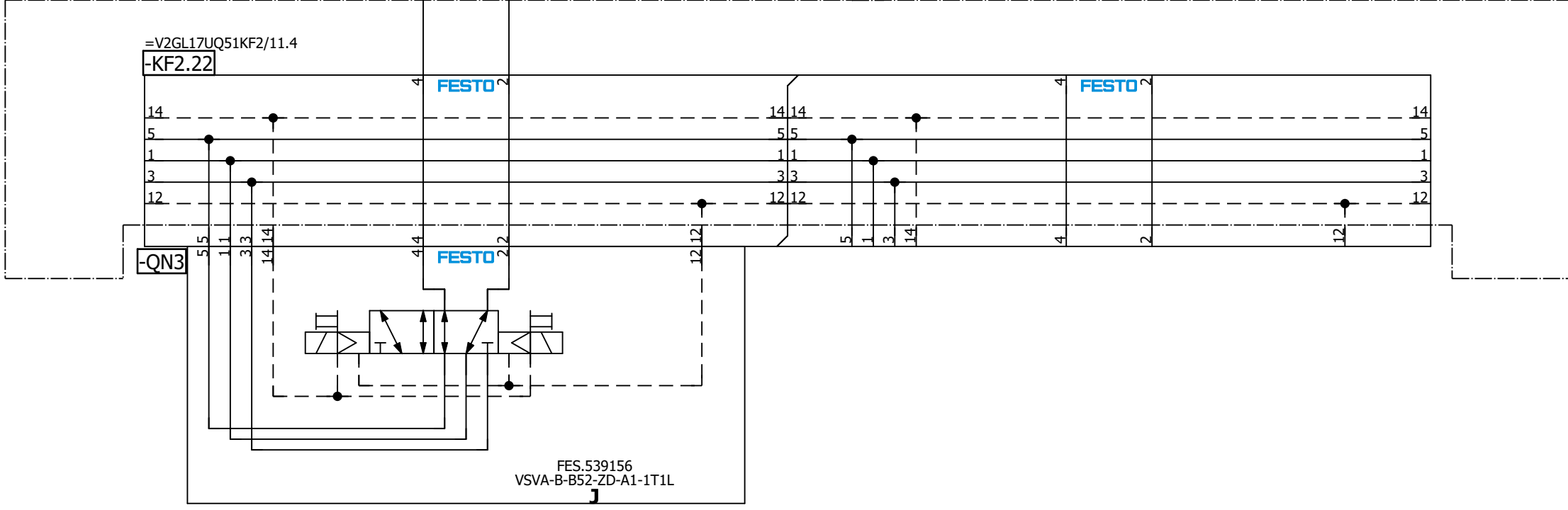

=V2GL17UQ51  
-UQ5-QN3.1  
Pallet Stop Sta #5  
Mid-Stop#2 (RST)

=V2GL17UQ51  
-UQ5-QN3.2  
Pallet Stop Sta #5  
Mid-Stop#2 (SET)

=V2GL17UQ51UQ4/1

=V2GL17UQ51UQ8/1

Date		1/18/2023	Volvo Trucks North America		Valiant TMS	Pallet Stop Station #5 Mid-Stop #2	Drawing name:		= V2GL17UQ51UQ5
Ed.		MKLEPADLO	P6700 Framing - Cell 2V01, KF1				=2V01&MFS-PNEU_KF1		+ V2GL17UQ51
Appr			Replacement of		Scale 1:1		Document type:		Page
Original			Replaced by				MFS	Project nr:	22-16152
Modification		Date	Name	Original					275



A2

=KH0+KH0/1.8 / +V2GL18KH1-P1 →

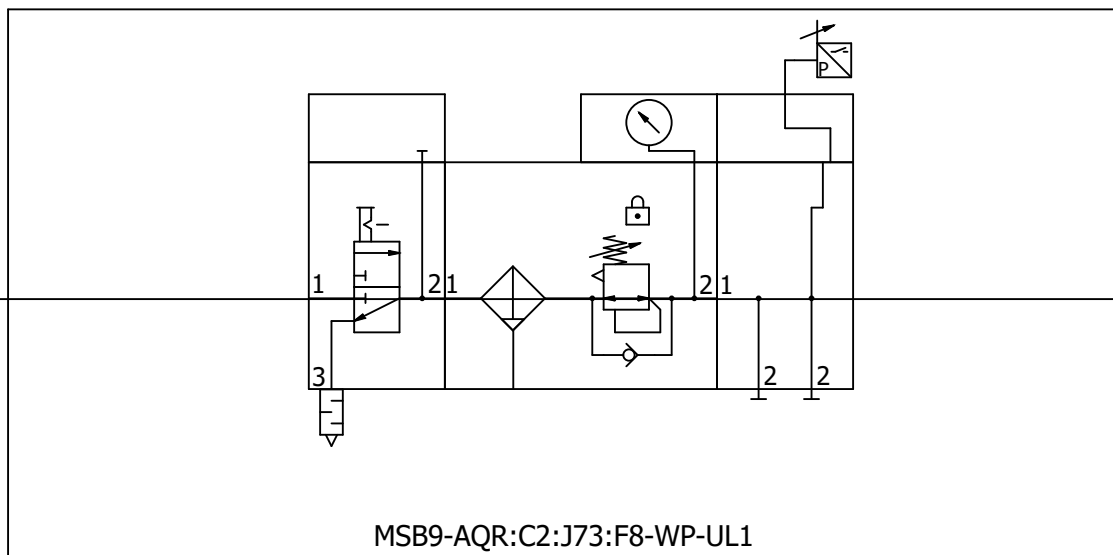

→ +V2GL18UQ51-P1 / =V2GL18UQ51KF2+V2GL18UQ51/11.0

MSB9-AQR:C2:J73:F8-WP-UL1

=V2GL17UQ51UQ8+V2GL17UQ51/1

=V2GL18UQ51KF2+V2GL18UQ51/5

			Date	12/20/2022	Volvo Trucks North America	Valiant TMS	Incoming air supply (Conveyor)	Drawing name:		= V2GL18	
			Ed.	MKLEPADLO				=2V01&MFS-PNEU_KF1		+ KH1	
			Appr					P6700 Framing - Cell 2V01, KF1		Document type:	Project nr:
Modification	Date	Name	Original		Replacement of	Replaced by	Scale 1:1	MFS	22-16152	1	
										275	

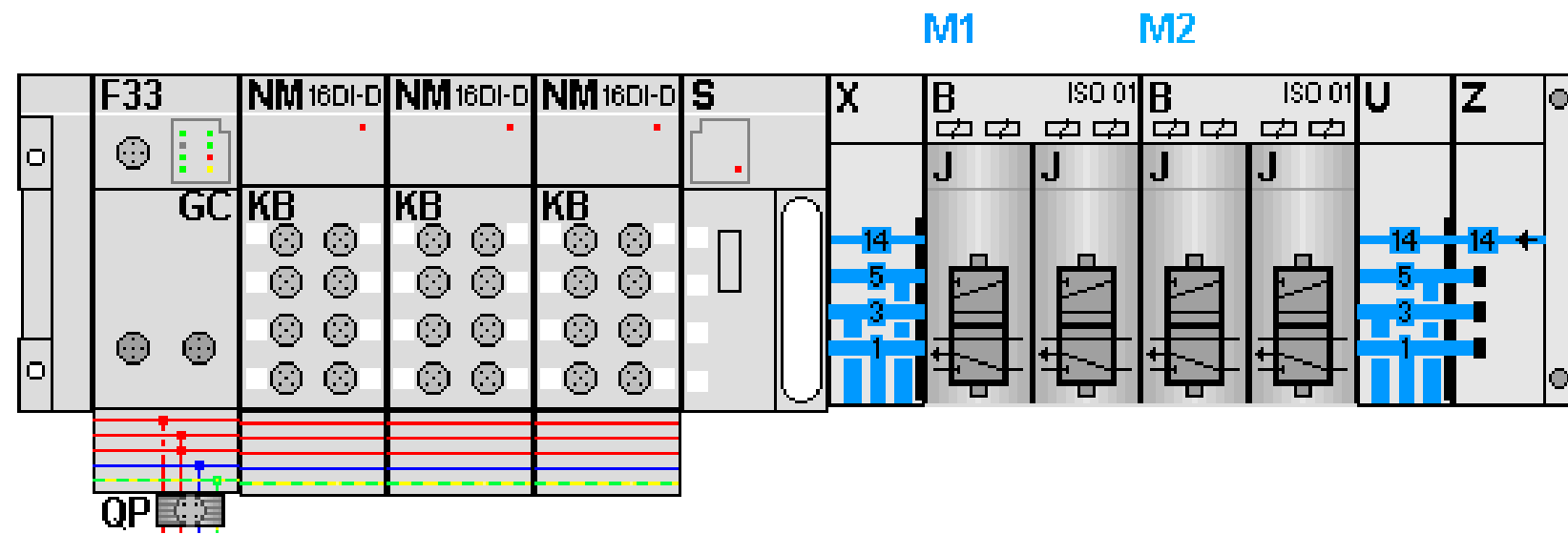

KF2.0

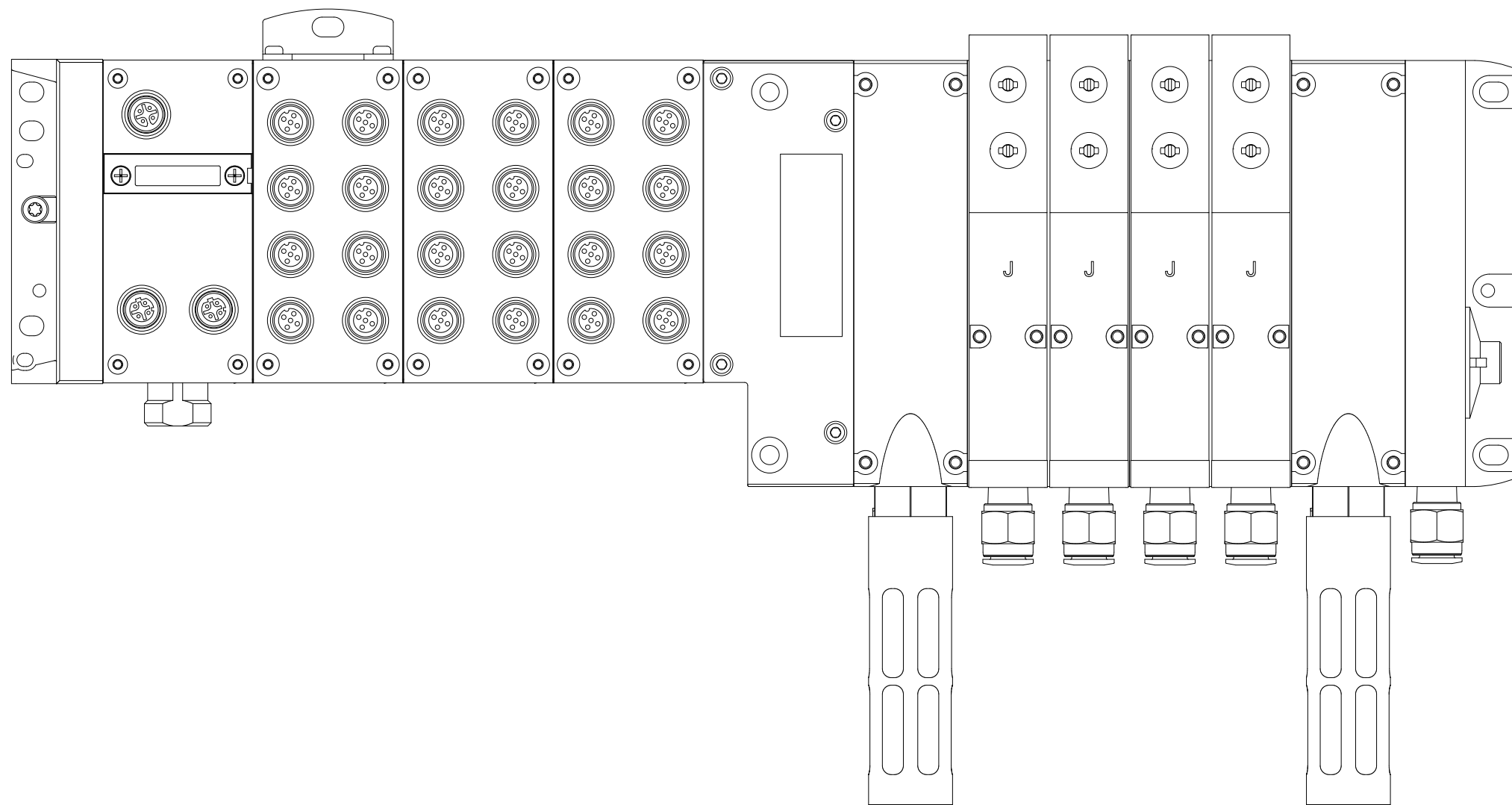

=V2GL18+KH1/1

11

Date		1/18/2023	Volvo Trucks North America		Valiant TMS	AIR SUPPLY CONFIGURATION	Drawing name:		= V2GL18UQ51KF2
Ed.		MKLEPADLO	P6700 Framing - Cell 2V01, KF1				=2V01&MFS-PNEU_KF1		+ V2GL18UQ51
Appr			Replacement of		Scale 1:1	Document type:	Project nr:	MFS	22-16152
Modification	Date	Name	Original	Replaced by					
									275

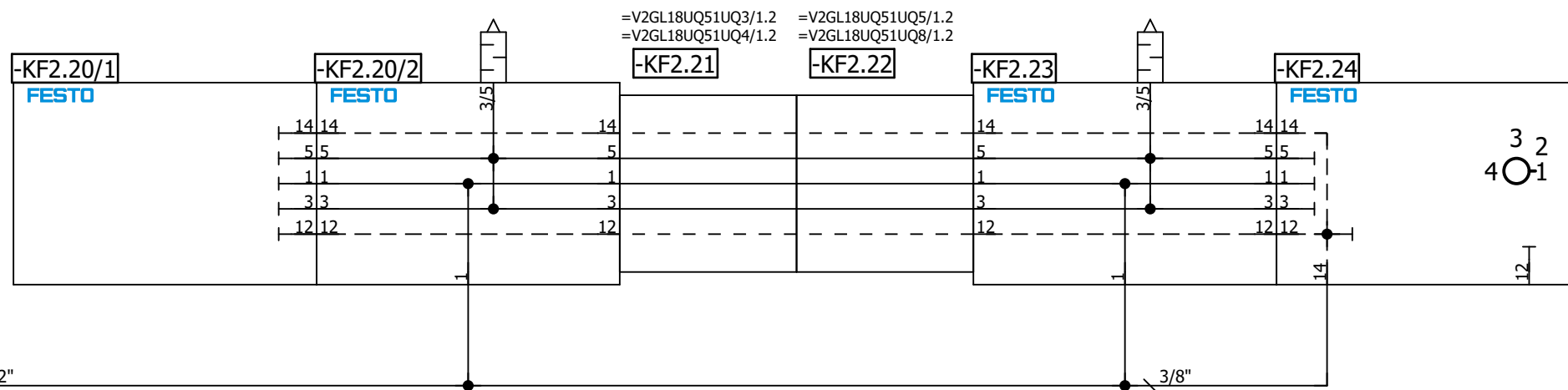
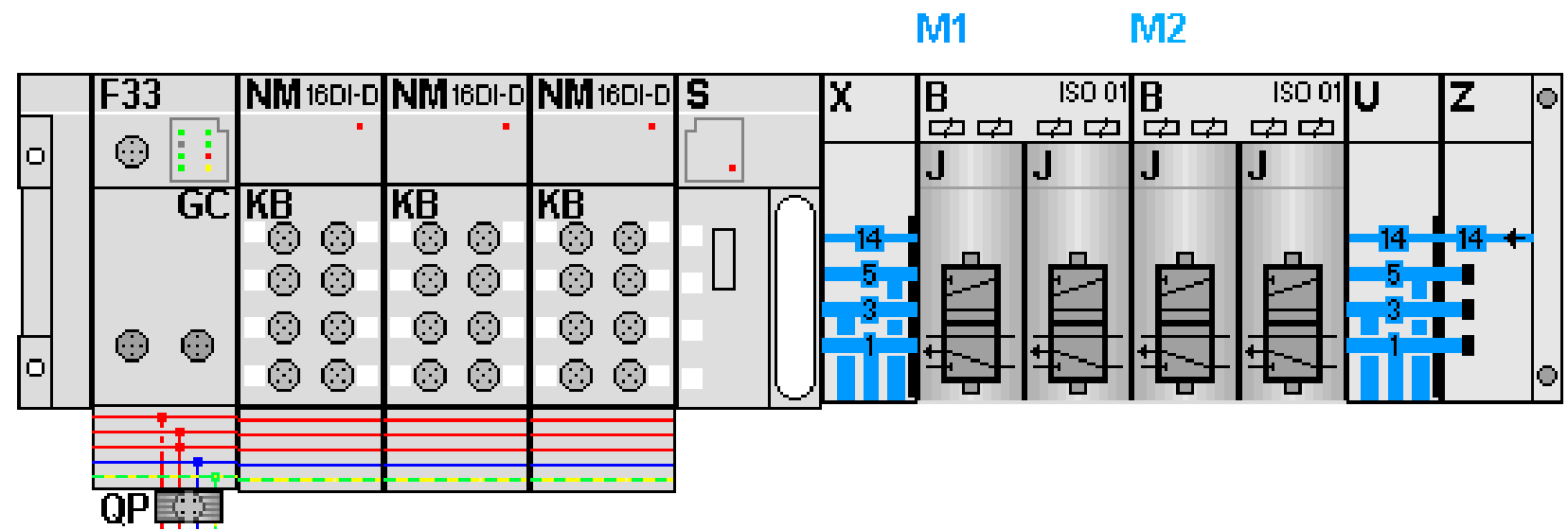

=V2GL18+KH1/1.6 / P1 → 1/2"

3/8"

Date	1/18/2023	Volvo Trucks North America	Valiant TMS	AIR SUPPLY	Drawing name:	= V2GL18UQ51KF2
Ed.	MKLEPADLO	P6700 Framing - Cell 2V01, KF1			Document type:	MFS
Appr.		Replacement of	Replaced by	Scale 1:1		Page 11
Modification	Date	Name	Original			275





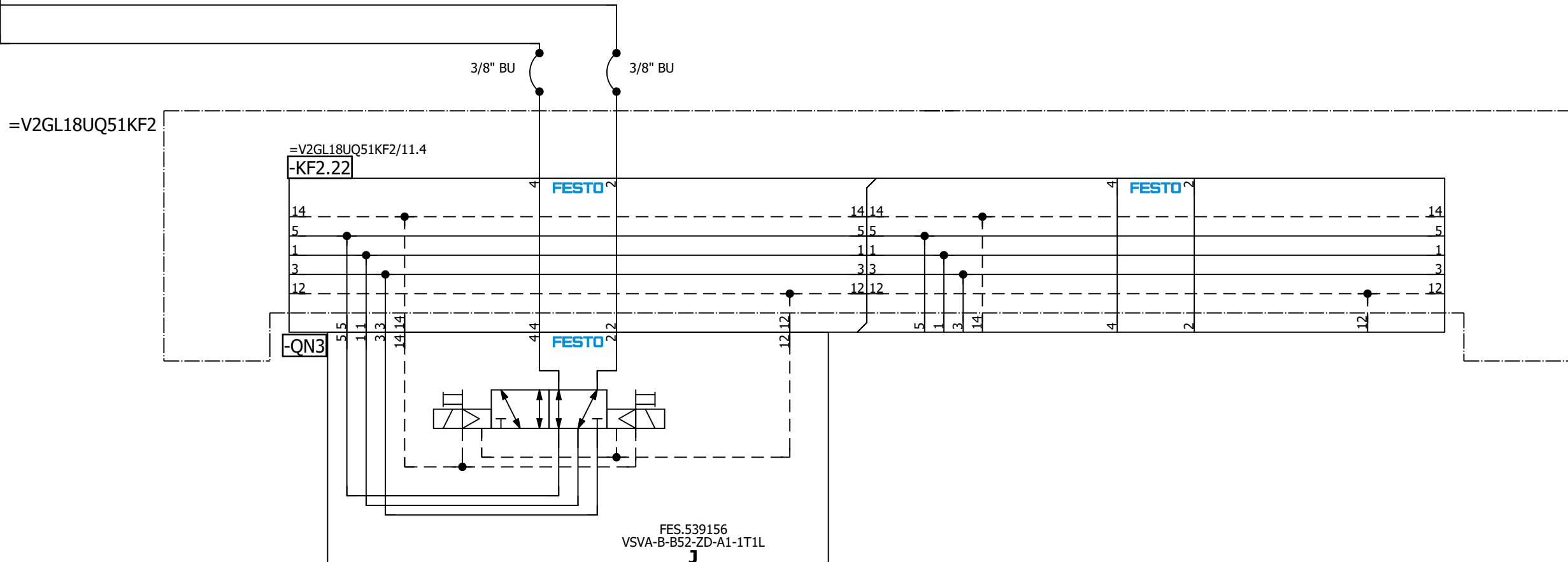
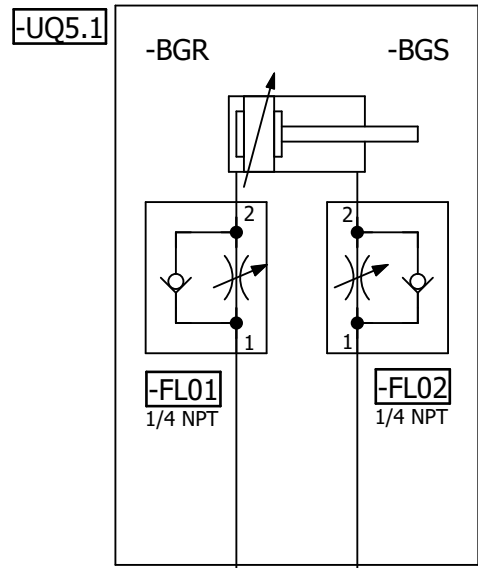

=V2GL18UQ51  
-UQ5-QN3.1  
Pallet Stop Sta #5  
Mid-Stop#2 (RST)

=V2GL18UQ51  
-UQ5-QN3.2  
Pallet Stop Sta #5  
Mid-Stop#2 (SET)

=V2GL18UQ51UQ4/1

=V2GL18UQ51UQ8/1

Date		1/18/2023	Volvo Trucks North America		Valiant TMS	Pallet Stop Station #5 Mid-Stop #2	Drawing name:		= V2GL18UQ51UQ5
Ed.		MKLEPADLO	P6700 Framing - Cell 2V01, KF1				=2V01&MFS-PNEU_KF1		+ V2GL18UQ51
Appr			Replacement of		Scale 1:1	Document type:		MFS	Project nr: 22-16152
Original			Replaced by			Page		1	
Modification	Date	Name	Original						275









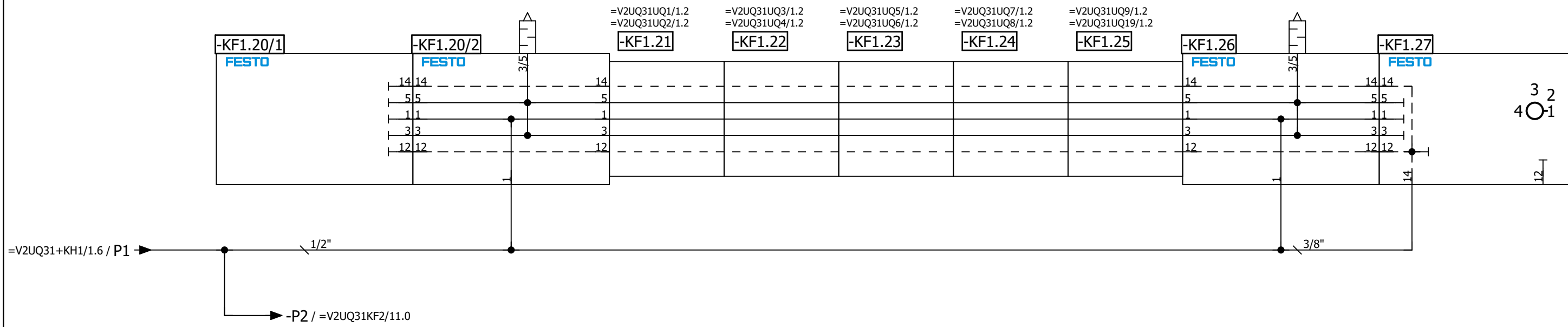
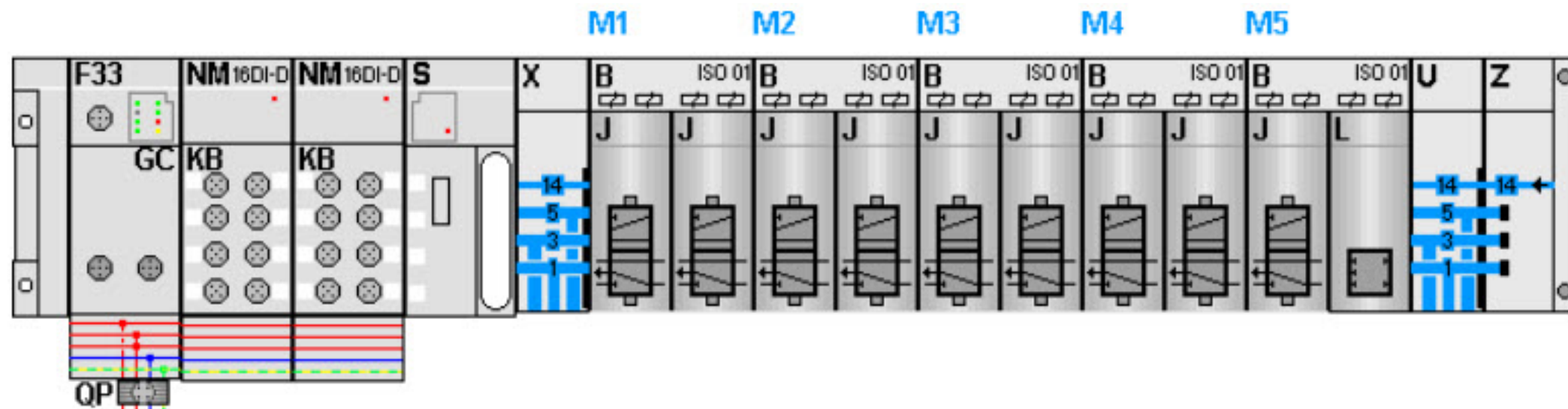

Date		1/18/2023		Volvo Trucks North America		Valiant TMS		AIR SUPPLY		Drawing name:		= V2UQ31KF1	
Ed.		MKLEPADLO		P6700 Framing - Cell 2V01, KF1		Scale 1:1				Document type:		= 2V01&MFS-PNEU_KF1	
Appr.				Replacement of		Replaced by				Project nr:		22-16152	
Modification	Date	Name	Original							MFS		Page 11	
												275	

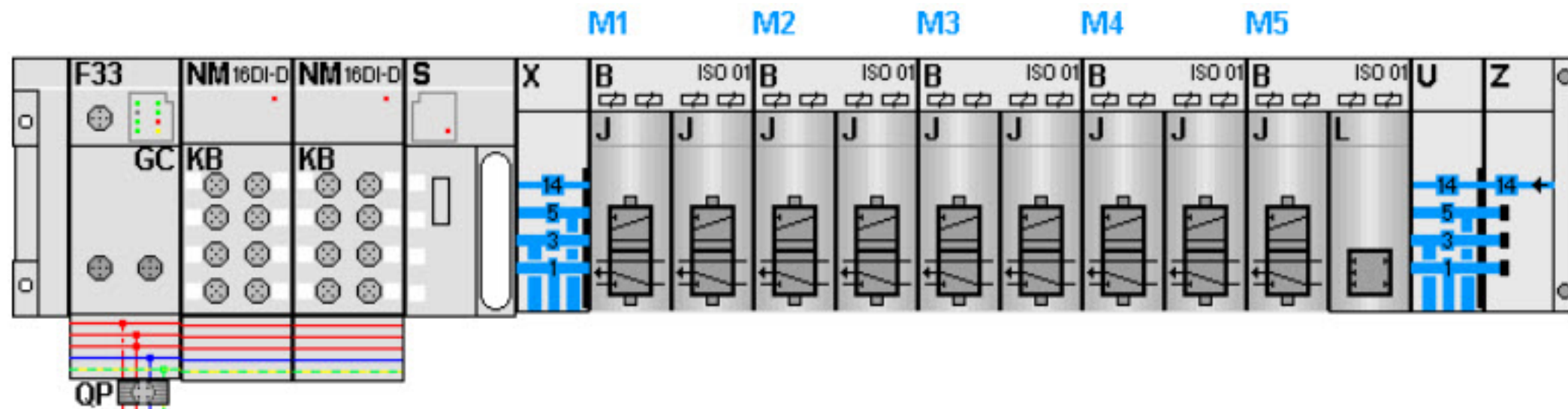

KF2.0

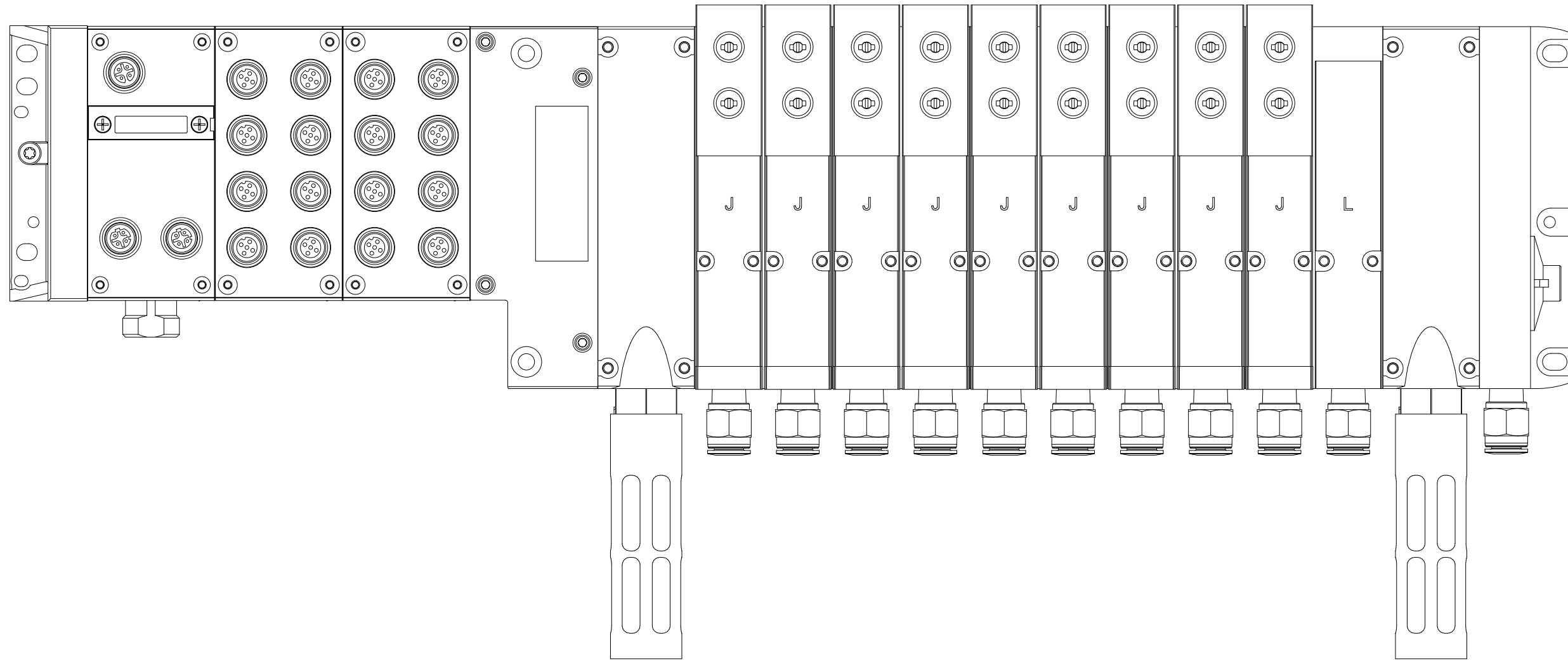

=V2UQ31KF1/11

Date		1/18/2023	Volvo Trucks North America		Valiant TMS	AIR SUPPLY CONFIGURATION	Drawing name:		= V2UQ31KF2
Ed.		MKLEPADLO	P6700 Framing - Cell 2V01, KF1				=2V01&MFS-PNEU_KF1		+ V2UQ31
Appr			Replacement of		Scale 1:1		Document type:		MFS
Modification	Date	Name	Replaced by				Project nr:		22-16152
									275







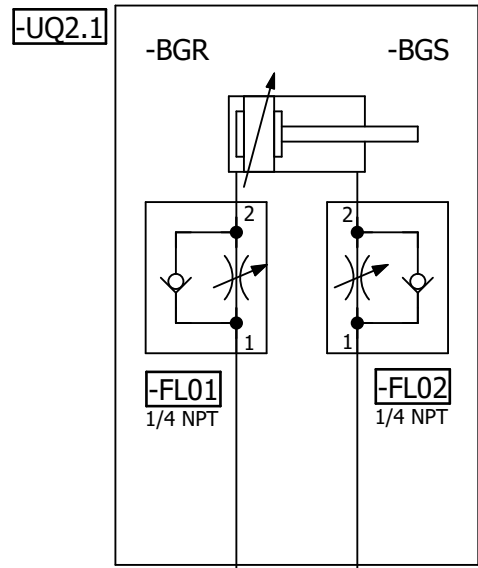

=V2UQ31KF1

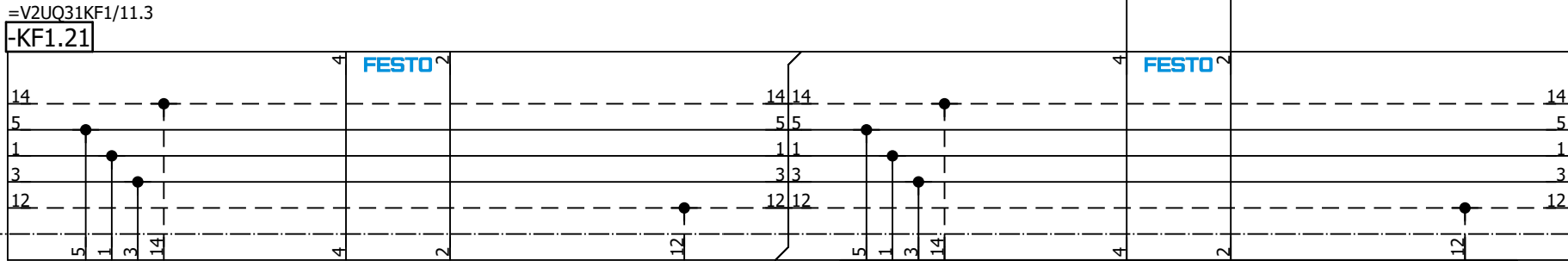

3/8" BU

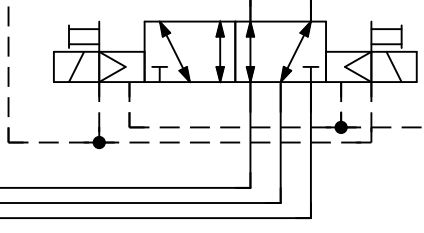

FES.539156  
VSVA-B-B52-ZD-A1-1T1L

=V2UQ31  
-UQ2-QN2.1  
LH Common  
Clamp 2 (RST)

=V2UQ31  
-UQ2-QN2.2  
LH Common  
Clamp 2 (SET)

=V2UQ31UQ1/1

=V2UQ31UQ3/1

Date		12/20/2022	Volvo Trucks North America		Valiant TMS	LH Common Clamp 2	Drawing name:		= V2UQ31UQ2
Ed.		MKLEPADLO	P6700 Framing - Cell 2V01, KF1				=2V01&MFS-PNEU_KF1		+ V2UQ31
Appr.			Replacement of		Scale 1:1		Document type:		Project nr:
Original			Replaced by				MFS		22-16152
Modification		Date	Name	Original					275



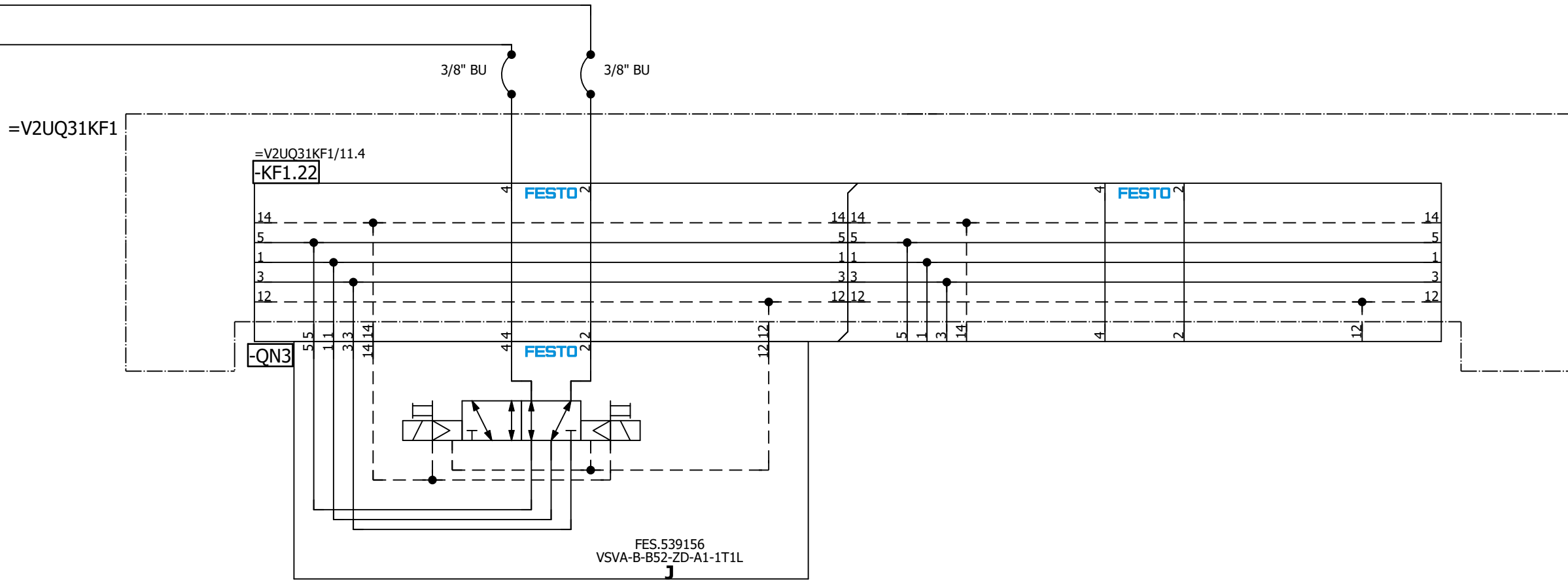
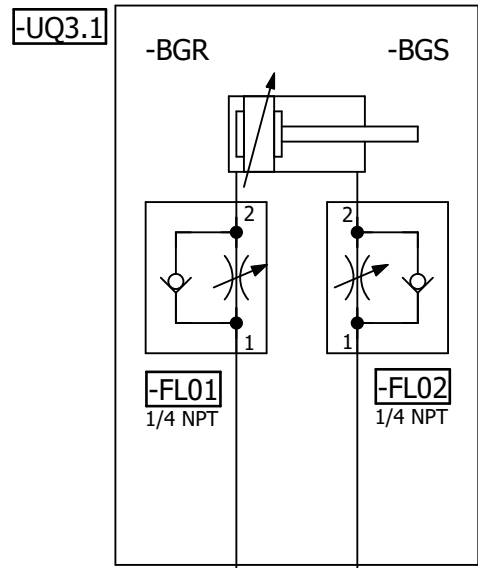

**=V2UQ31**  
**-UQ3-QN3.1**  
**LH Common**  
**Clamp 3 (RST)**

**=V2UQ31**  
**-UQ3-QN3.2**  
**LH Common**  
**Clamp 3 (SET)**

=V2UQ31UQ2/1

=V2UQ31UQ4/1

Date: 12/20/2022		Volvo Trucks North America		Valiant TMS		LH Common Clamp 3		Drawing name: =2V01&MFS-PNEU_KF1		= V2UQ31UQ3	
Ed.: MKLEPADLO		P6700 Framing - Cell 2V01, KF1		Scale 1:1				Document type: MFS		Project nr: 22-16152	
Appr:		Replacement of		Replaced by				Page: 1		275	
Modification	Date	Name	Original								

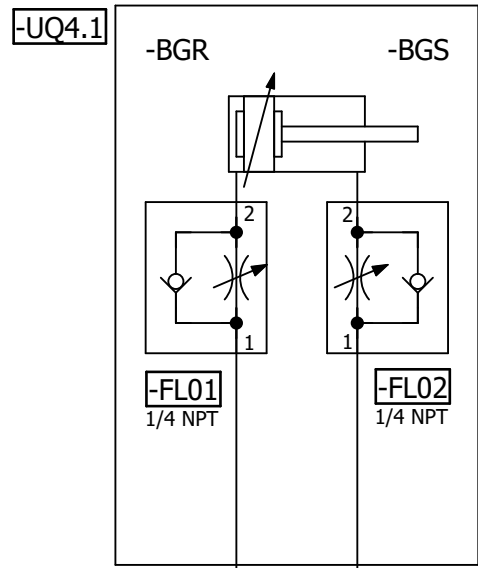

=V2UQ31KF1

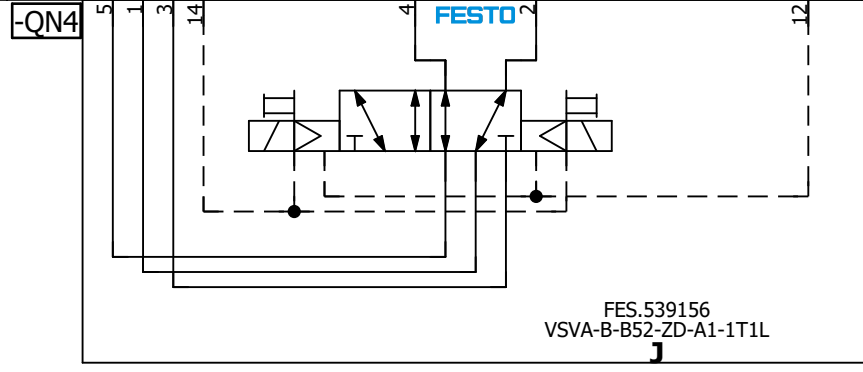
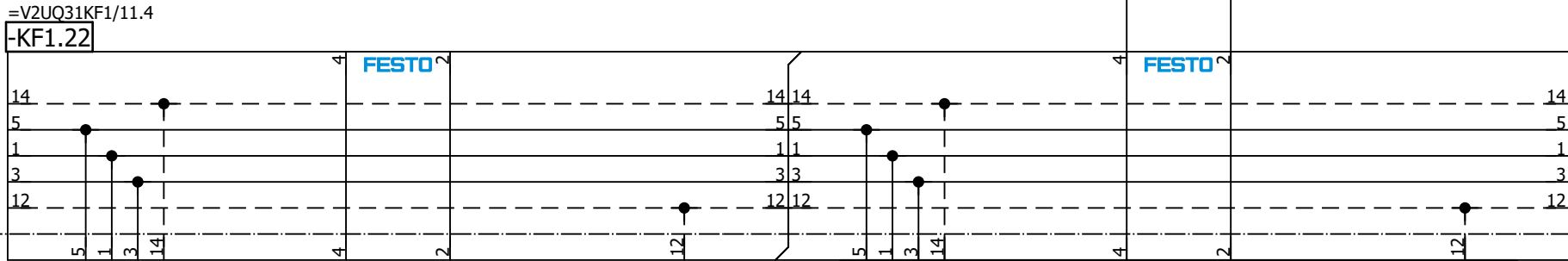

=V2UQ31  
-UQ4-QN4.1  
LH L150 Model  
Clamp 1 (RST)

=V2UQ31  
-UQ4-QN4.2  
LH L150 Model  
Clamp 1 (SET)

=V2UQ31UQ3/1

=V2UQ31UQ5/1

Date		12/20/2022	Volvo Trucks North America		Valiant TMS	LH L150 Model Clamp 1	Drawing name:		= V2UQ31UQ4
Ed.		MKLEPADLO	P6700 Framing - Cell 2V01, KF1				=2V01&MFS-PNEU_KF1		+ V2UQ31
Appr			Replacement of		Scale 1:1		Document type:		Project nr:
Original			Replaced by				MFS		22-16152
									275





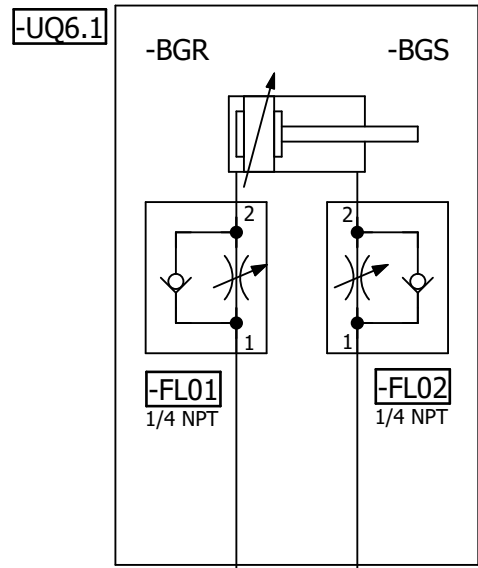

=V2UQ31KF1

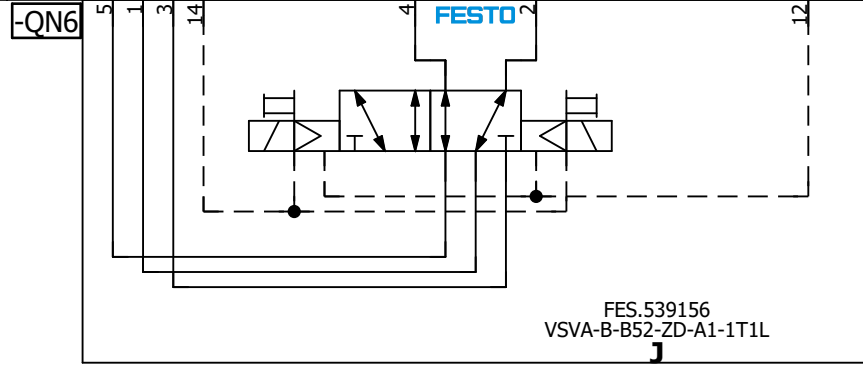
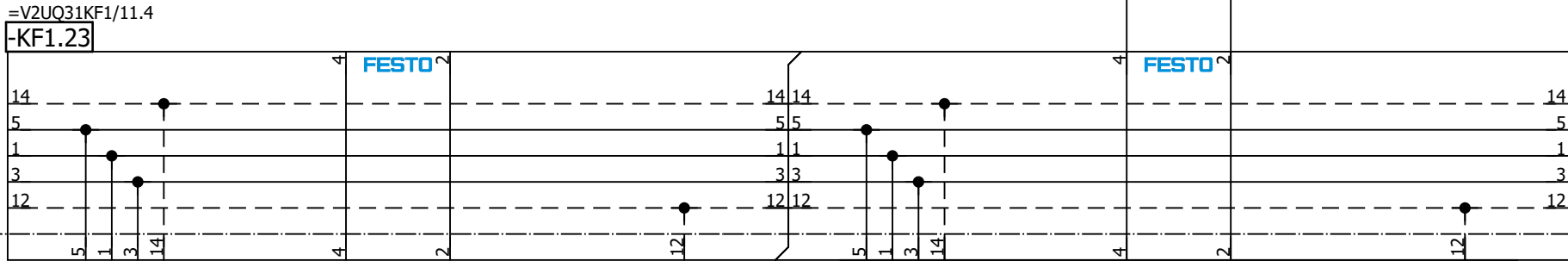

=V2UQ31  
-UQ6-QN6.1  
LH L150 Model  
Clamp 3 (RST)

=V2UQ31  
-UQ6-QN6.2  
LH L150 Model  
Clamp 3 (SET)

=V2UQ31UQ5/1

=V2UQ31UQ7/1

Date		12/20/2022	Volvo Trucks North America		 Valiant TMS LH L150 Model Clamp 3	Drawing name:		= V2UQ31UQ6	
Ed.		MKLEPADLO	P6700 Framing - Cell 2V01, KF1			Document type:		= 2V01&MFS-PNEU_KF1	
Appr.			Replacement of		Scale 1:1	Project nr:		22-16152	
Original			Replaced by			Document type:		MFS	
Modification	Date	Name	Original			Page		1	
								275	

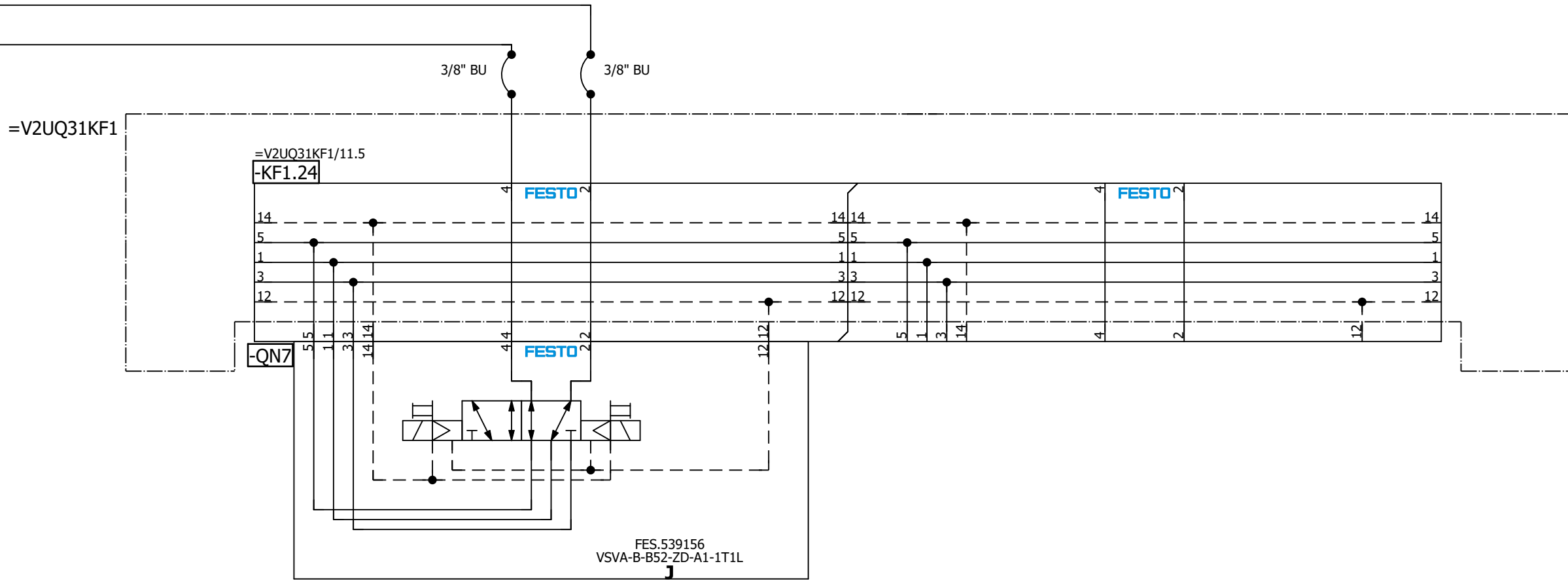
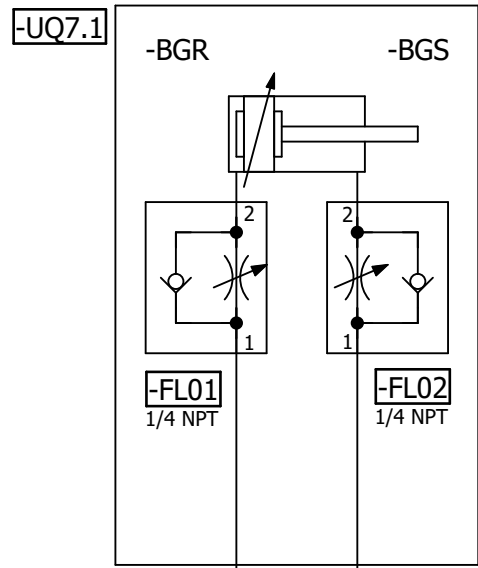

=V2UQ31  
-UQ7-QN7.1  
LH L230/290/320  
Clamp 1 (RST)

=V2UQ31  
-UQ7-QN7.2  
LH L230/290/320  
Clamp 1 (SET)

=V2UQ31UQ6/1

=V2UQ31UQ8/1

Date: 12/20/2022		Volvo Trucks North America		Valiant TMS		LH L230/290/320 Model Clamp 1		Drawing name: =V2UQ31UQ7 + V2UQ31		Page: 1	
Ed.: MKLEPADLO		P6700 Framing - Cell 2V01, KF1		Scale 1:1				Document type: MFS		Project nr: 22-16152	
Modification	Date	Name	Original	Replacement of	Replaced by					Page: 275	

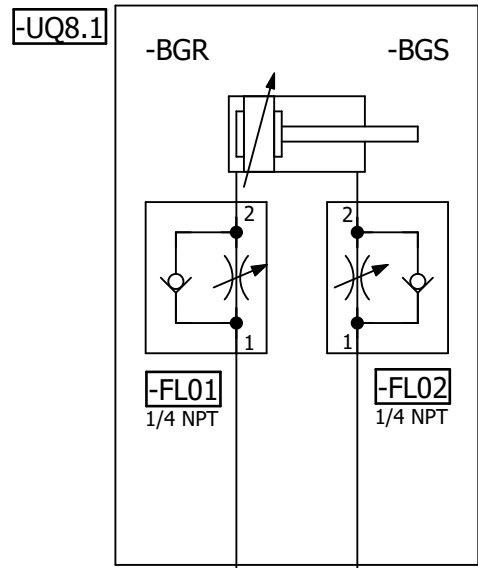

=V2UQ31KF1

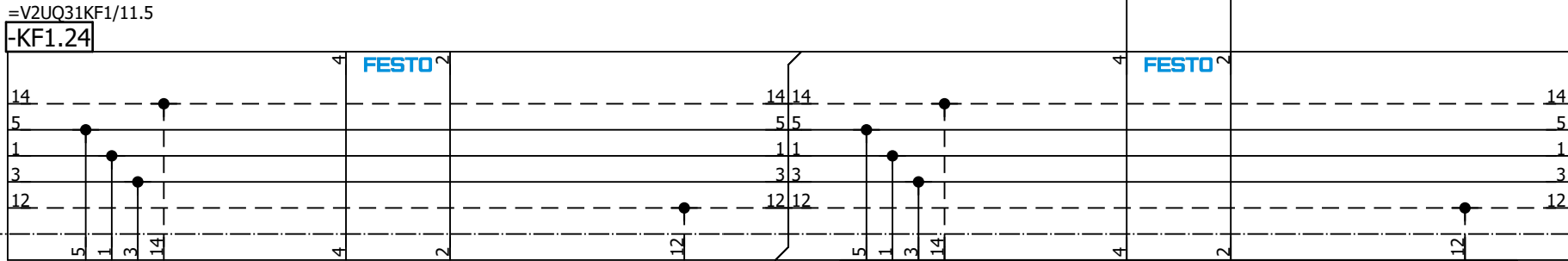

3/8" BU 3/8" BU

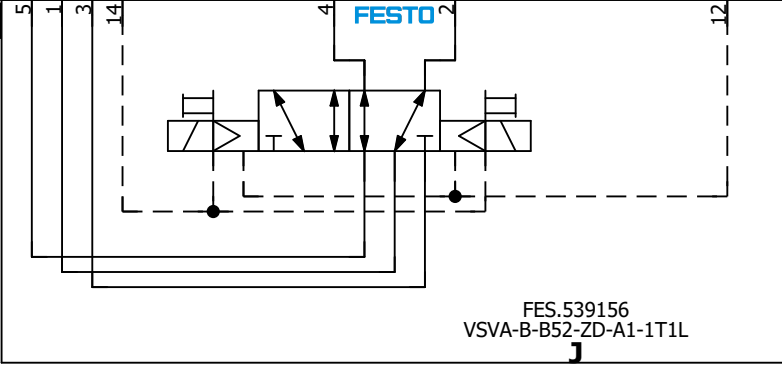

=V2UQ31  
-UQ8-QN8.1  
LH L230/290/320  
Clamp 2 (RST)

=V2UQ31  
-UQ8-QN8.2  
LH L230/290/320  
Clamp 2 (SET)

=V2UQ31UQ9/1

=V2UQ31UQ7/1

Date		12/20/2022	Volvo Trucks North America			Valiant TMS	LH L230/290/320 Model Clamp 2	Drawing name: =2V01&MFS-PNEU_KF1		= V2UQ31UQ8 + V2UQ31	
Ed.		MKLEPADLO	P6700 Framing - Cell 2V01, KF1			Scale 1:1		Document type: MFS	Project nr: 22-16152	Page	1
Modification	Date	Name	Original	Replacement of	Replaced by						275

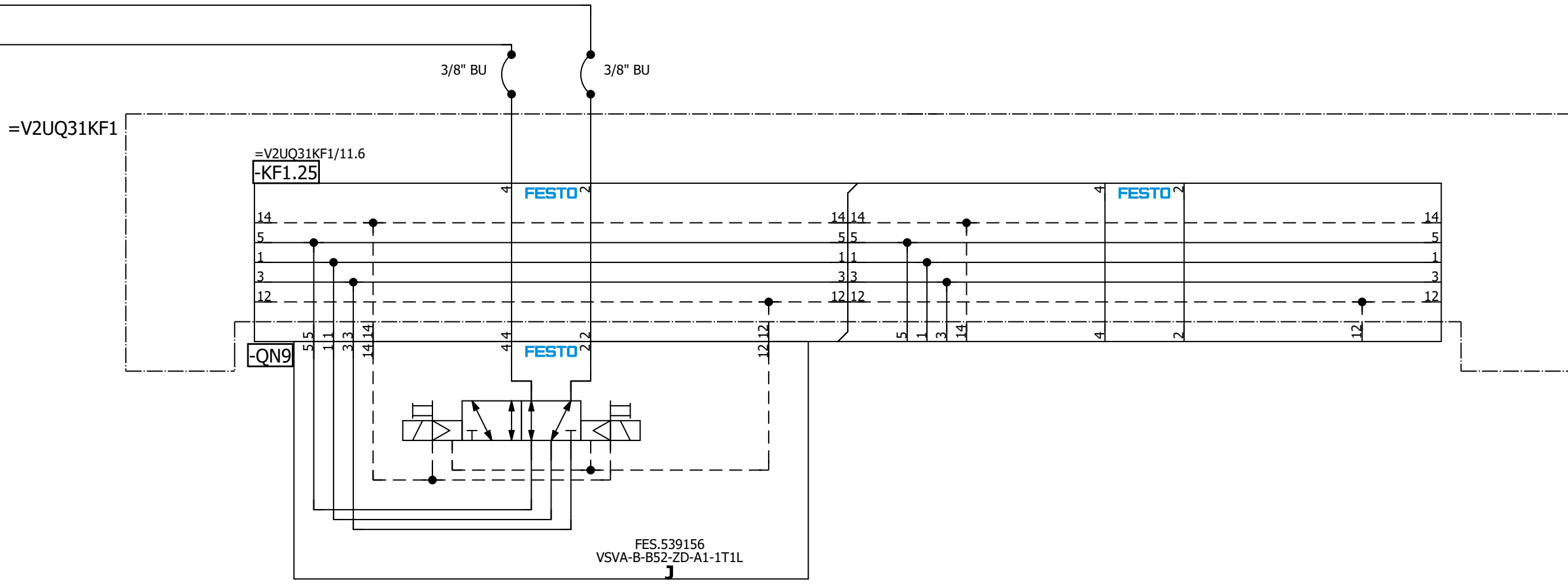
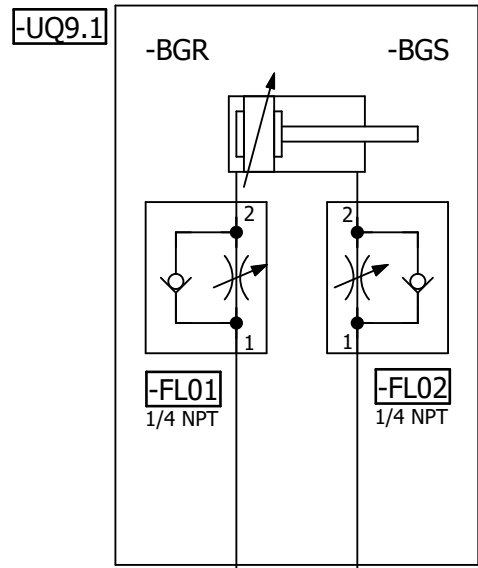

=V2UQ31  
-UQ9-QN9.1  
LH L230/290/320  
Clamp 3 (RST)

=V2UQ31  
-UQ9-QN9.2  
LH L230/290/320  
Clamp 3 (SET)

=V2UQ31UQ8/1 =V2UQ31UQ10/1

Date		12/20/2022	Volvo Trucks North America		Valiant TMS	LH L230/290/320 Model Clamp 3	Drawing name:		= V2UQ31UQ9		
Ed.		MKLEPADLO	P6700 Framing - Cell 2V01, KF1				=2V01&MFS-PNEU_KF1		+ V2UQ31		Page
Appr			Replacement of		Scale 1:1		Document type:	Project nr:	22-16152		
Modification	Date	Name	Original	Replaced by			MFS			Page	275







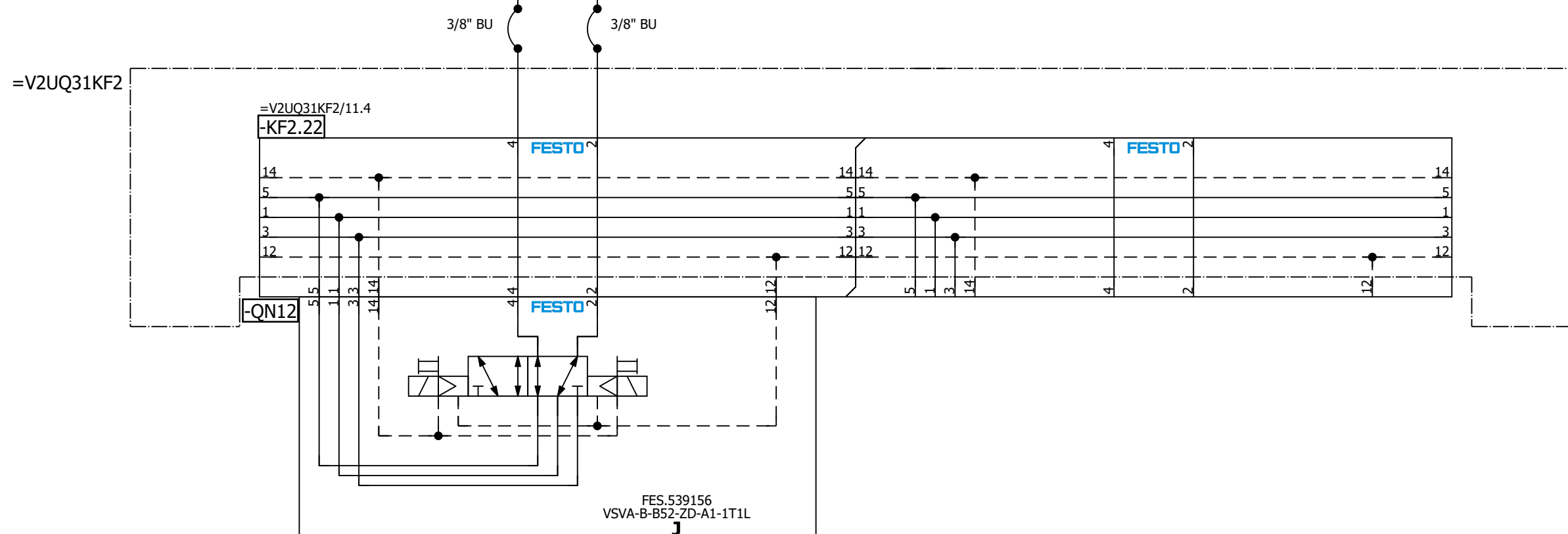
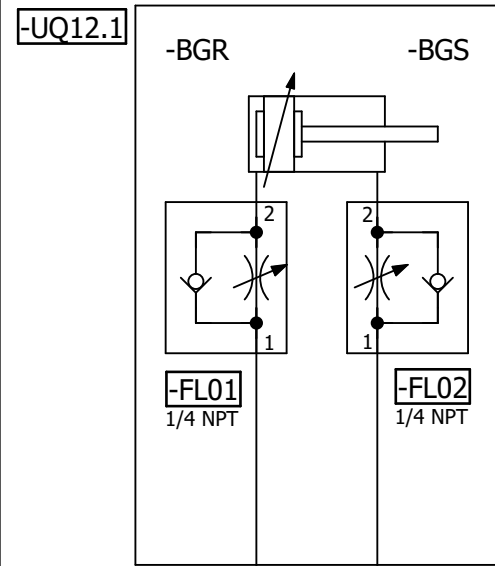

=V2UQ31  
-UQ12-QN12.1  
RH Common  
Clamp 3 (RST)

=V2UQ31  
-UQ12-QN12.2  
RH Common  
Clamp 3 (SET)

=V2UQ31UQ11/1

=V2UQ31UQ13/1

Date: 12/20/2022		Volvo Trucks North America		Valiant TMS		Drawing name: =2V01&MFS-PNEU_KF1		= V2UQ31UQ12	
Ed.: MKLEPADLO		P6700 Framing - Cell 2V01, KF1		RH Common Clamp 3		Document type: MFS		+ V2UQ31	
Appr:		Replacement of		Scale 1:1		Project nr: 22-16152		Page 1	
Original		Replaced by						275	

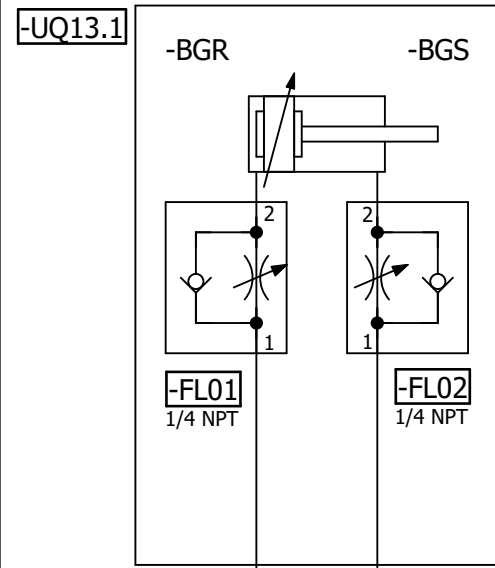

=V2UQ31KF2

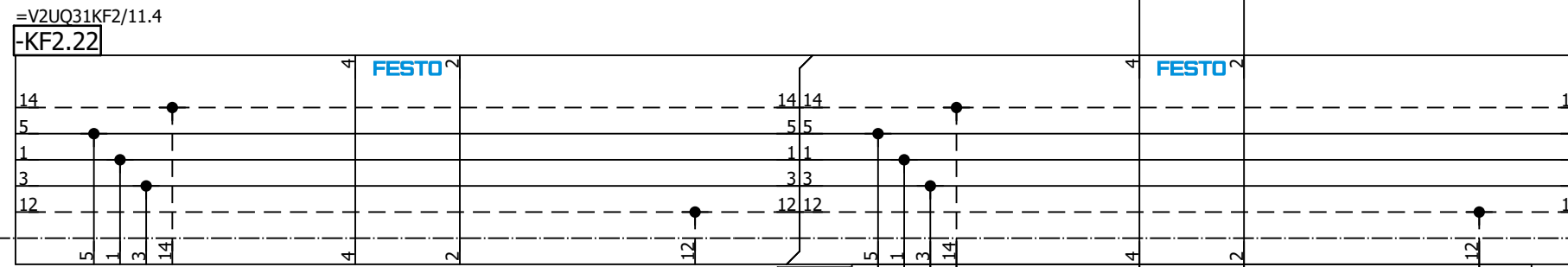

-QN13

FESTO

FES.539156  
VSVA-B-B52-ZD-A1-1T1L

=V2UQ31  
-UQ13-QN13.1  
RH L150 Model  
Clamp 1 (RST)

=V2UQ31  
-UQ13-QN13.2  
RH L150 Model  
Clamp 1 (SET)

=V2UQ31UQ12/1

=V2UQ31UQ14/1

Date		12/20/2022	Volvo Trucks North America			Valiant TMS		RH L150 Model Clamp 1		Drawing name: =2V01&MFS-PNEU_KF1		= V2UQ31UQ13		
Ed.		MKLEPADLO	P6700 Framing - Cell 2V01, KF1			Scale 1:1				Document type: MFS		Project nr: 22-16152		Page 1
Modification	Date	Name	Original	Replacement of	Replaced by							+ V2UQ31		Page 275

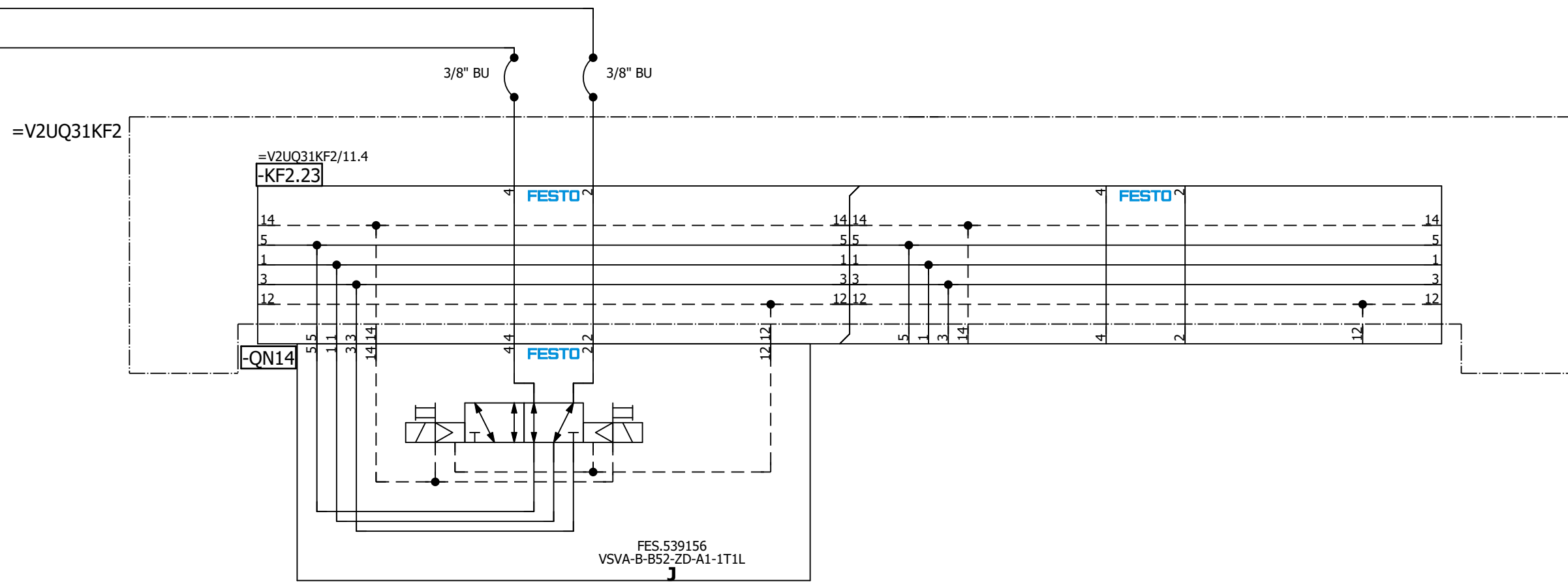
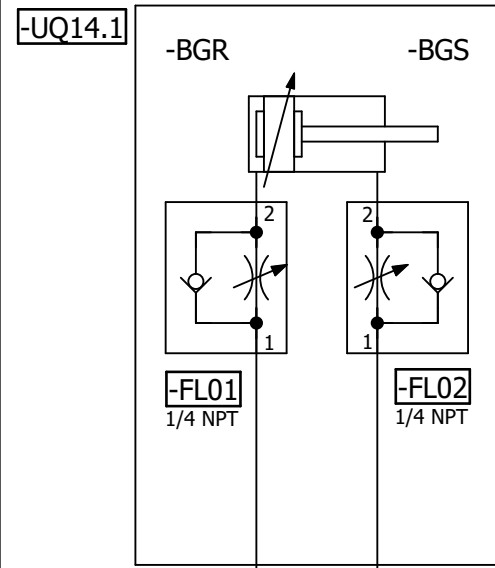

=V2UQ31  
-UQ14-QN14.1  
RH L150 Model  
Clamp 2 (RST)

=V2UQ31  
-UQ14-QN14.2  
RH L150 Model  
Clamp 2 (SET)

=V2UQ31UQ13/1

=V2UQ31UQ15/1

Date		12/20/2022	Volvo Trucks North America		 Valiant TMS RH L150 Model Clamp 2	Drawing name:		= V2UQ31UQ14	
Ed.		MKLEPADLO	P6700 Framing - Cell 2V01, KF1			Document type:		= 2V01&MFS-PNEU_KF1	
Appr.			Replacement of		Scale 1:1	Project nr:		22-16152	
Original			Replaced by			Document type:		MFS	
Modification	Date	Name	Original			Page		1	
								275	

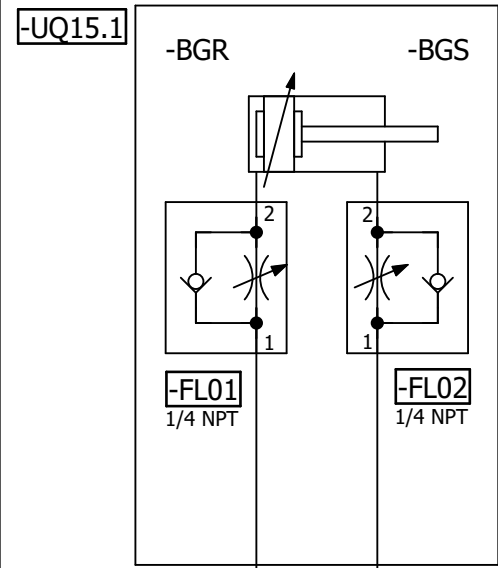

=V2UQ31KF2

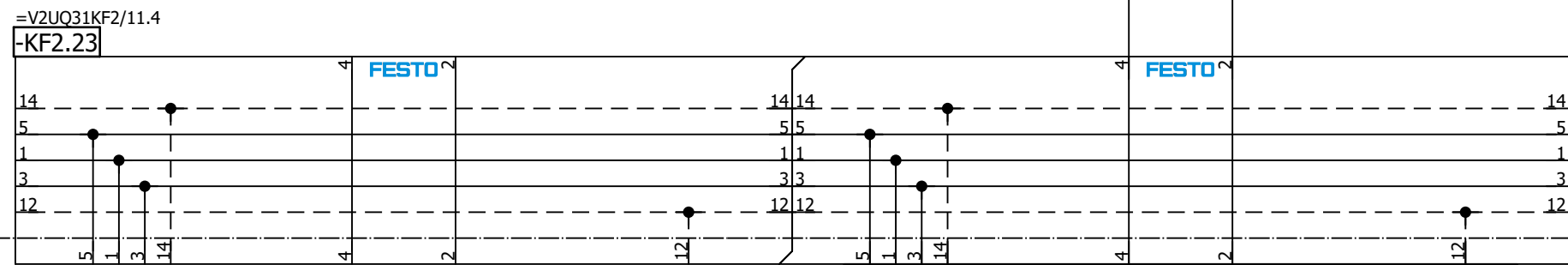

-QN15

FESTO

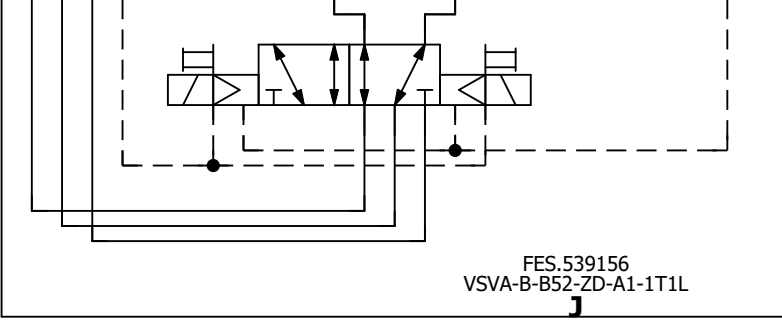

=V2UQ31  
-UQ15-QN15.1  
RH L150 Model  
Clamp 3 (RST)

=V2UQ31  
-UQ15-QN15.2  
RH L150 Model  
Clamp 3 (SET)

=V2UQ31UQ14/1

=V2UQ31UQ16/1

Date		12/20/2022	Volvo Trucks North America		Valiant TMS	RH L150 Model Clamp 3	Drawing name:		= V2UQ31UQ15
Ed.		MKLEPADLO	P6700 Framing - Cell 2V01, KF1				=2V01&MFS-PNEU_KF1		+ V2UQ31
Appr			Replacement of		Scale 1:1	Document type:		Project nr:	Page
Original			Replaced by			MFS		22-16152	1
									275



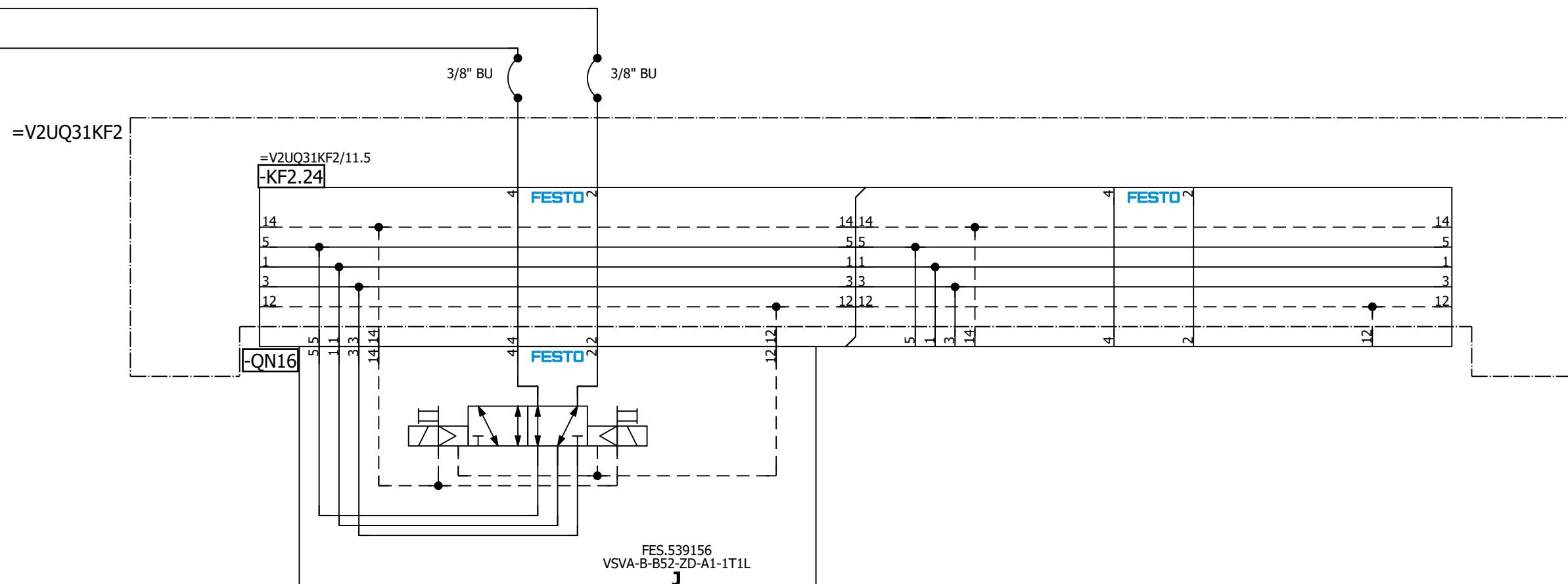
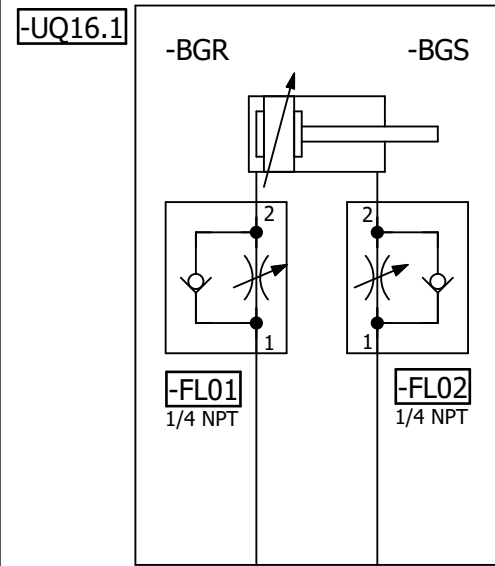

=V2UQ31  
-UQ16-QN16.1  
RH L230/290/320  
Clamp 1 (RST)

=V2UQ31  
-UQ16-QN16.2  
RH L230/290/320  
Clamp 1 (SET)

=V2UQ31UQ15/1

=V2UQ31UQ17/1

Date		12/20/2022	Volvo Trucks North America		 Valiant TMS Scale 1:1	Drawing name:		= V2UQ31UQ16	
Ed.		MKLEPADLO	P6700 Framing - Cell 2V01, KF1			Document type:		=2V01&MFS-PNEU_KF1	
Appr			Replacement of		Project nr:		22-16152		
Original			Replaced by		Page		1		
Modification		Date	Name	Original	Scale 1:1		Page		
							275		















# Parts list

F01\_001

Device tag	Quantity	Designation	Type number	Supplier	Part number
=V1AR11UQ41KF1-KF1.0	1	Valve Manifold	51E-F33GCQPNMKBNMKBNMKB-D-UL1+GS2GZBA & 32P-TJQ-R-MBHBHBHBHBH-10J	FES	FES.51E-F33GCQPNMKBNMKBNMKB-D-UL1+GS2GZBA & 32P-TJQ-R-MBHBHBHBHBH-10J
=V1AR11UQ41KF1-KF1.21	0	Subbase	VMPA2-FB-AP-2-1		FES.538000
=V1AR11UQ41KF1-KF1.22	0	Subbase	VMPA2-FB-AP-2-1		FES.538000
=V1AR11UQ41KF1-KF1.23	0	Subbase	VMPA2-FB-AP-2-1		FES.538000
=V1AR11UQ41KF1-KF1.24	0	Subbase	VMPA2-FB-AP-2-1		FES.538000
=V1AR11UQ41KF1-KF1.25	0	Subbase	VMPA2-FB-AP-2-1		FES.538000
=V1AR11UQ41UQ1-QN1	0	Solenoid valve	VMPA2-M1H-J-PI		FES.537953
=V1AR11UQ41UQ1-UQ1.1-FL01	1	One-way flow control valve	GRLA-1/4-QB-1/4-U	FES	FES.534661
=V1AR11UQ41UQ1-UQ1.1-FL02	1	One-way flow control valve	GRLA-1/4-QB-1/4-U	FES	FES.534661
=V1AR11UQ41UQ1-UQ1.2-FL01	1	One-way flow control valve	GRLA-1/4-QB-1/4-U	FES	FES.534661
=V1AR11UQ41UQ1-UQ1.2-FL02	1	One-way flow control valve	GRLA-1/4-QB-1/4-U	FES	FES.534661
=V1AR11UQ41UQ2-QN2	0	Solenoid valve	VMPA2-M1H-J-PI		FES.537953
=V1AR11UQ41UQ2-UQ2.1-FL01	1	One-way flow control valve	GRLA-1/4-QB-1/4-U	FES	FES.534661
=V1AR11UQ41UQ2-UQ2.1-FL02	1	One-way flow control valve	GRLA-1/4-QB-1/4-U	FES	FES.534661
=V1AR11UQ41UQ2-UQ2.2-FL01	1	One-way flow control valve	GRLA-1/4-QB-1/4-U	FES	FES.534661
=V1AR11UQ41UQ2-UQ2.2-FL02	1	One-way flow control valve	GRLA-1/4-QB-1/4-U	FES	FES.534661
=V1AR11UQ41UQ3-QN3	0	Solenoid valve	VMPA2-M1H-J-PI		FES.537953
=V1AR11UQ41UQ3-UQ3.1-FL01	1	One-way flow control valve	GRLA-1/4-QB-1/4-U	FES	FES.534661
=V1AR11UQ41UQ3-UQ3.1-FL02	1	One-way flow control valve	GRLA-1/4-QB-1/4-U	FES	FES.534661
=V1AR11UQ41UQ3-UQ3.2-FL01	1	One-way flow control valve	GRLA-1/4-QB-1/4-U	FES	FES.534661
=V1AR11UQ41UQ3-UQ3.2-FL02	1	One-way flow control valve	GRLA-1/4-QB-1/4-U	FES	FES.534661
=V1AR11UQ41UQ4-QN4	0	Solenoid valve	VMPA2-M1H-J-PI		FES.537953
=V1AR11UQ41UQ4-UQ4.1-FL01	1	One-way flow control valve	GRLA-1/4-QB-1/4-U	FES	FES.534661
=V1AR11UQ41UQ4-UQ4.1-FL02	1	One-way flow control valve	GRLA-1/4-QB-1/4-U	FES	FES.534661
=V1AR11UQ41UQ4-UQ4.2-FL01	1	One-way flow control valve	GRLA-1/4-QB-1/4-U	FES	FES.534661
=V1AR11UQ41UQ4-UQ4.2-FL02	1	One-way flow control valve	GRLA-1/4-QB-1/4-U	FES	FES.534661
=V1AR11UQ41UQ5-QN5	0	Solenoid valve	VMPA2-M1H-J-PI		FES.537953
=V1AR11UQ41UQ5-UQ5.1-FL01	1	One-way flow control valve	GRLA-1/4-QB-1/4-U	FES	FES.534661
=V1AR11UQ41UQ5-UQ5.1-FL02	1	One-way flow control valve	GRLA-1/4-QB-1/4-U	FES	FES.534661
=V1AR11UQ41UQ5-UQ5.2-FL01	1	One-way flow control valve	GRLA-1/4-QB-1/4-U	FES	FES.534661
=V1AR11UQ41UQ5-UQ5.2-FL02	1	One-way flow control valve	GRLA-1/4-QB-1/4-U	FES	FES.534661
=V1AR11UQ41UQ6-QN6	0	Solenoid valve	VMPA2-M1H-J-PI		FES.537953
=V1AR11UQ41UQ7-QN7	0	Solenoid valve	VMPA2-M1H-J-PI		FES.537953
=V1AR11UQ41UQ8-QN8	0	Solenoid valve	VMPA2-M1H-J-PI		FES.537953
=V1AR11UQ41UQ9-QN9	0	Solenoid valve	VMPA2-M1H-J-PI		FES.537953
=V1AR11UQ41UQ10-QN10	0	Solenoid valve	VMPA2-M1H-J-PI		FES.537953

+KH1/1

+AR31KF1/1

Date	1/18/2023	Volvo Trucks North America	Valiant TMS	Parts list :	Drawing name:	=	
Ed.	MKLEPADLO	P6700 Framing - Cell 2V01, KF1	Scale 1:1	FES.51E-F33GCQPNMKBNMKBNMKB-D-UL1+GS2GZBA & 32P-TJQ-R-MBHBHBHBHBH-10J - FES.537953	F2V01&MFS-PNEU_KF1	+ V1AR11UQ41	
Appr							Document type:
Modification	Date	Name	Original	Replaced by	MPB	22-16152	1
							275











# Parts list

F01\_001

Device tag	Quantity	Designation	Type number	Supplier	Part number
=V1GL13UQ51KF2-KF2.0	1	Valve Manifold	51E-F33GCQPNMKBNMKBNMKBNMKB-S-UL1+GS2GZBA & 45PN-R-Z-LSMX-BBU-3JL	FES	FES.51E-F33GCQPNMKBNMKBNMKBNMKB-S-UL1+GS2GZBA & 45PN-R-Z-LSMX-BBU-3JL
=V1GL13UQ51KF2-KF2.21	0	Manifold subbase	VABV-S4-1HS-N14-2T2		FES.546213
=V1GL13UQ51KF2-KF2.22	0	Manifold subbase	VABV-S4-1HS-N14-2T2		FES.546213
=V1GL13UQ51UQ5-QN1	0	Solenoid valve	VSVA-B-B52-ZD-A1-1T1L	FES	FES.539156
=V1GL13UQ51UQ5-UQ5.1-FL01	1	One-way flow control valve	GRLA-1/4-QB-3/8-U		FES.534663
=V1GL13UQ51UQ5-UQ5.1-FL02	1	One-way flow control valve	GRLA-1/4-QB-3/8-U		FES.534663
=V1GL13UQ51UQ6-QN2	0	Solenoid valve	VSVA-B-B52-ZD-A1-1T1L	FES	FES.539156
=V1GL13UQ51UQ6-UQ6.1-FL01	1	One-way flow control valve	GRLA-1/4-QB-3/8-U		FES.534663
=V1GL13UQ51UQ6-UQ6.1-FL02	1	One-way flow control valve	GRLA-1/4-QB-3/8-U		FES.534663
=V1GL13UQ51UQ7-QN3	0	Solenoid valve	VSVA-B-B52-ZD-A1-1T1L	FES	FES.539156
=V1GL13UQ51UQ7-UQ7.1-FL01	1	One-way flow control valve	GRLA-1/4-QB-3/8-U		FES.534663
=V1GL13UQ51UQ7-UQ7.1-FL02	1	One-way flow control valve	GRLA-1/4-QB-3/8-U		FES.534663
=V1GL13UQ51UQ12-QN4	0	Blanking plate	VABB-S4-1-WT		FES.539212



# Parts list

F01\_001

Device tag	Quantity	Designation	Type number	Supplier	Part number
=V1UL1UQ1-UQ1.1-FL01	1	One-way flow control valve	GRLA-1/4-QB-3/8-U		FES.534663
=V1UL1UQ1-UQ1.1-FL02	1	One-way flow control valve	GRLA-1/4-QB-3/8-U		FES.534663
=V1UL1UQ1-UQ1.2-FL01	1	One-way flow control valve	GRLA-1/4-QB-3/8-U		FES.534663
=V1UL1UQ1-UQ1.2-FL02	1	One-way flow control valve	GRLA-1/4-QB-3/8-U		FES.534663
=V1UL1UQ1-UQ1.3-FL01	1	One-way flow control valve	GRLA-1/4-QB-3/8-U		FES.534663
=V1UL1UQ1-UQ1.3-FL02	1	One-way flow control valve	GRLA-1/4-QB-3/8-U		FES.534663
=V1UL1UQ1-UQ1.4-FL01	1	One-way flow control valve	GRLA-1/4-QB-3/8-U		FES.534663
=V1UL1UQ1-UQ1.4-FL02	1	One-way flow control valve	GRLA-1/4-QB-3/8-U		FES.534663
=V1UL1UQ2-UQ2.1-FL01	1	One-way flow control valve	GRLA-1/4-QB-3/8-U		FES.534663
=V1UL1UQ2-UQ2.1-FL02	1	One-way flow control valve	GRLA-1/4-QB-3/8-U		FES.534663
=V1UL1UQ2-UQ2.2-FL01	1	One-way flow control valve	GRLA-1/4-QB-3/8-U		FES.534663
=V1UL1UQ2-UQ2.2-FL02	1	One-way flow control valve	GRLA-1/4-QB-3/8-U		FES.534663
=V1UL1UQ3-UQ3.1-FL01	1	One-way flow control valve	GRLA-1/4-QB-3/8-U		FES.534663
=V1UL1UQ3-UQ3.1-FL02	1	One-way flow control valve	GRLA-1/4-QB-3/8-U		FES.534663
=V1UL1UQ3-UQ3.2-FL01	1	One-way flow control valve	GRLA-1/4-QB-3/8-U		FES.534663
=V1UL1UQ3-UQ3.2-FL02	1	One-way flow control valve	GRLA-1/4-QB-3/8-U		FES.534663
=V1UL1UQ4-UQ4.1-FL01	1	One-way flow control valve	GRLA-1/4-QB-3/8-U		FES.534663
=V1UL1UQ4-UQ4.1-FL02	1	One-way flow control valve	GRLA-1/4-QB-3/8-U		FES.534663
=V1UL1UQ4-UQ4.2-FL01	1	One-way flow control valve	GRLA-1/4-QB-3/8-U		FES.534663
=V1UL1UQ4-UQ4.2-FL02	1	One-way flow control valve	GRLA-1/4-QB-3/8-U		FES.534663

+ .GL14UQ51/1

+ .UQ31/1















# Parts list

F01\_001

Device tag	Quantity	Designation	Type number	Supplier	Part number
=V2AR32UQ41KF1-KF1.0	1	Valve Manifold	51E-F33GCQPNMKBNMKBNMK-B-D-UL1+GS2GZBA & 32P-TJQ-R-MBHBHBHBH-8J	FES	FES.51E-F33GCQPNMKBNMKBNMK-B-D-UL1+GS2GZBA & 32P-TJQ-R-MBHBHBHBH-8J
=V2AR32UQ41KF1-KF1.21	0	Subbase	VMPA2-FB-AP-2-1		FES.538000
=V2AR32UQ41KF1-KF1.22	0	Subbase	VMPA2-FB-AP-2-1		FES.538000
=V2AR32UQ41KF1-KF1.23	0	Subbase	VMPA2-FB-AP-2-1		FES.538000
=V2AR32UQ41KF1-KF1.24	0	Subbase	VMPA2-FB-AP-2-1		FES.538000
=V2AR32UQ41UQ1-QN1	0	Solenoid valve	VMPA2-M1H-J-PI		FES.537953
=V2AR32UQ41UQ1-UQ1.1-FL01	1	One-way flow control valve	GRLA-1/8-QB-1/4-U	FES	FES.534658
=V2AR32UQ41UQ1-UQ1.1-FL02	1	One-way flow control valve	GRLA-1/8-QB-1/4-U	FES	FES.534658
=V2AR32UQ41UQ2-QN2	0	Solenoid valve	VMPA2-M1H-J-PI		FES.537953
=V2AR32UQ41UQ2-UQ2.1-FL01	1	One-way flow control valve	GRLA-1/4-QB-1/4-U	FES	FES.534661
=V2AR32UQ41UQ2-UQ2.1-FL02	1	One-way flow control valve	GRLA-1/4-QB-1/4-U	FES	FES.534661
=V2AR32UQ41UQ2-UQ2.2-FL01	1	One-way flow control valve	GRLA-1/4-QB-1/4-U	FES	FES.534661
=V2AR32UQ41UQ2-UQ2.2-FL02	1	One-way flow control valve	GRLA-1/4-QB-1/4-U	FES	FES.534661
=V2AR32UQ41UQ2-UQ2.3-FL01	1	One-way flow control valve	GRLA-1/4-QB-1/4-U	FES	FES.534661
=V2AR32UQ41UQ2-UQ2.3-FL02	1	One-way flow control valve	GRLA-1/4-QB-1/4-U	FES	FES.534661
=V2AR32UQ41UQ2-UQ2.4-FL01	1	One-way flow control valve	GRLA-1/4-QB-1/4-U	FES	FES.534661
=V2AR32UQ41UQ2-UQ2.4-FL02	1	One-way flow control valve	GRLA-1/4-QB-1/4-U	FES	FES.534661
=V2AR32UQ41UQ3-QN3	0	Solenoid valve	VMPA2-M1H-J-PI		FES.537953
=V2AR32UQ41UQ3-UQ3.1-FL01	1	One-way flow control valve	GRLA-1/4-QB-1/4-U	FES	FES.534661
=V2AR32UQ41UQ3-UQ3.1-FL02	1	One-way flow control valve	GRLA-1/4-QB-1/4-U	FES	FES.534661
=V2AR32UQ41UQ3-UQ3.2-FL01	1	One-way flow control valve	GRLA-1/4-QB-1/4-U	FES	FES.534661
=V2AR32UQ41UQ3-UQ3.2-FL02	1	One-way flow control valve	GRLA-1/4-QB-1/4-U	FES	FES.534661
=V2AR32UQ41UQ3-UQ3.3-FL01	1	One-way flow control valve	GRLA-1/4-QB-1/4-U	FES	FES.534661
=V2AR32UQ41UQ3-UQ3.3-FL02	1	One-way flow control valve	GRLA-1/4-QB-1/4-U	FES	FES.534661
=V2AR32UQ41UQ4-QN4	0	Solenoid valve	VMPA2-M1H-J-PI		FES.537953
=V2AR32UQ41UQ4-UQ4.1-FL01	1	One-way flow control valve	GRLA-1/8-QB-1/4-U	FES	FES.534658
=V2AR32UQ41UQ4-UQ4.1-FL02	1	One-way flow control valve	GRLA-1/8-QB-1/4-U	FES	FES.534658
=V2AR32UQ41UQ5-QN5	0	Solenoid valve	VMPA2-M1H-J-PI		FES.537953
=V2AR32UQ41UQ5-UQ5.1-FL01	1	One-way flow control valve	GRLA-1/4-QB-1/4-U	FES	FES.534661
=V2AR32UQ41UQ5-UQ5.1-FL02	1	One-way flow control valve	GRLA-1/4-QB-1/4-U	FES	FES.534661
=V2AR32UQ41UQ5-UQ5.2-FL01	1	One-way flow control valve	GRLA-1/4-QB-1/4-U	FES	FES.534661
=V2AR32UQ41UQ5-UQ5.2-FL02	1	One-way flow control valve	GRLA-1/4-QB-1/4-U	FES	FES.534661
=V2AR32UQ41UQ6-QN6	0	Solenoid valve	VMPA2-M1H-J-PI		FES.537953
=V2AR32UQ41UQ6-UQ6.1-FL01	1	One-way flow control valve	GRLA-1/8-QB-1/4-U	FES	FES.534658
=V2AR32UQ41UQ6-UQ6.1-FL02	1	One-way flow control valve	GRLA-1/8-QB-1/4-U	FES	FES.534658
=V2AR32UQ41UQ7-QN7	0	Solenoid valve	VMPA2-M1H-J-PI		FES.537953
=V2AR32UQ41UQ7-UQ7.1-FL01	1	One-way flow control valve	GRLA-1/4-QB-1/4-U	FES	FES.534661
=V2AR32UQ41UQ7-UQ7.1-FL02	1	One-way flow control valve	GRLA-1/4-QB-1/4-U	FES	FES.534661
=V2AR32UQ41UQ7-UQ7.2-FL01	1	One-way flow control valve	GRLA-1/4-QB-1/4-U	FES	FES.534661
=V2AR32UQ41UQ7-UQ7.2-FL02	1	One-way flow control valve	GRLA-1/4-QB-1/4-U	FES	FES.534661
=V2AR32UQ41UQ8-QN8	0	Solenoid valve	VMPA2-M1H-J-PI		FES.537953

+ .AR32KF1/1

+ .AR32UQ42/1

Date	1/18/2023	Volvo Trucks North America	Valiant TMS	Parts list :	Drawing name:	=	
Ed.	MKLEPADLO	P6700 Framing - Cell 2V01, KF1	Scale 1:1	FES.51E-F33GCQPNMKBNMKBNMK-B-D-UL1+GS2GZBA & 32P-TJQ-R-MBHBHBHBH-8J - FES.537953	F2V01&MFS-PNEU_KF1	+ V2AR32UQ41	
Appr							Document type:
Modification	Date	Name	Original	Replaced by	MPB	22-16152	1
							275



















# Parts list

F01\_001

Device tag	Quantity	Designation	Type number	Supplier	Part number
=V2AR43UQ43KF1-KF1.0	1	Valve Manifold	51E-F33GCQPNMKBNMKBNMKB-D-UL1+GS2GZBA & 32P-TJQ-R-MBHBH-4J	FES	FES.51E-F33GCQPNMKBNMKBNMKB-D-UL1+GS2GZBA & 32P-TJQ-R-MBHBH-4J
=V2AR43UQ43KF1-KF1.21	0	Subbase	VMPA2-FB-AP-2-1		FES.538000
=V2AR43UQ43KF1-KF1.22	0	Subbase	VMPA2-FB-AP-2-1		FES.538000
=V2AR43UQ43UQ1-QN1	0	Solenoid valve	VMPA2-M1H-J-PI		FES.537953
=V2AR43UQ43UQ1-UQ1.1-FL01	1	One-way flow control valve	GRLA-1/8-QB-1/4-U	FES	FES.534658
=V2AR43UQ43UQ1-UQ1.1-FL02	1	One-way flow control valve	GRLA-1/8-QB-1/4-U	FES	FES.534658
=V2AR43UQ43UQ2-QN2	0	Solenoid valve	VMPA2-M1H-J-PI		FES.537953
=V2AR43UQ43UQ2-UQ2.1-FL01	1	One-way flow control valve	GRLA-1/4-QB-1/4-U	FES	FES.534661
=V2AR43UQ43UQ2-UQ2.1-FL02	1	One-way flow control valve	GRLA-1/4-QB-1/4-U	FES	FES.534661
=V2AR43UQ43UQ2-UQ2.2-FL01	1	One-way flow control valve	GRLA-1/4-QB-1/4-U	FES	FES.534661
=V2AR43UQ43UQ2-UQ2.2-FL02	1	One-way flow control valve	GRLA-1/4-QB-1/4-U	FES	FES.534661
=V2AR43UQ43UQ2-UQ2.3-FL01	1	One-way flow control valve	GRLA-1/4-QB-1/4-U	FES	FES.534661
=V2AR43UQ43UQ2-UQ2.3-FL02	1	One-way flow control valve	GRLA-1/4-QB-1/4-U	FES	FES.534661
=V2AR43UQ43UQ3-QN3	0	Solenoid valve	VMPA2-M1H-J-PI		FES.537953
=V2AR43UQ43UQ4-QN4	0	Solenoid valve	VMPA2-M1H-J-PI		FES.537953
=V2AR43UQ43UQ4-UQ4.1-FL01	1	One-way flow control valve	GRLA-1/4-QB-1/4-U	FES	FES.534661
=V2AR43UQ43UQ4-UQ4.1-FL02	1	One-way flow control valve	GRLA-1/4-QB-1/4-U	FES	FES.534661
=V2AR43UQ43UQ4-UQ4.2-FL01	1	One-way flow control valve	GRLA-1/4-QB-1/4-U	FES	FES.534661
=V2AR43UQ43UQ4-UQ4.2-FL02	1	One-way flow control valve	GRLA-1/4-QB-1/4-U	FES	FES.534661
=V2AR43UQ43UQ4-UQ4.3-FL01	1	One-way flow control valve	GRLA-1/4-QB-1/4-U	FES	FES.534661
=V2AR43UQ43UQ4-UQ4.3-FL02	1	One-way flow control valve	GRLA-1/4-QB-1/4-U	FES	FES.534661
=V2AR43UQ43UQ4-UQ4.4-FL01	1	One-way flow control valve	GRLA-1/4-QB-1/4-U	FES	FES.534661
=V2AR43UQ43UQ4-UQ4.4-FL02	1	One-way flow control valve	GRLA-1/4-QB-1/4-U	FES	FES.534661
=V2AR43UQ43UQ4-UQ4.5-FL01	1	One-way flow control valve	GRLA-1/4-QB-1/4-U	FES	FES.534661
=V2AR43UQ43UQ4-UQ4.5-FL02	1	One-way flow control valve	GRLA-1/4-QB-1/4-U	FES	FES.534661

+ .AR43UQ42/1

+ .AR44UQ41/1

Date		1/18/2023		Volvo Trucks North America		Valiant TMS		Parts list :		Drawing name:		=	
Ed.		MKLEPADLO		P6700 Framing - Cell 2V01, KF1		Scale 1:1		FES.51E-F33GCQPNMKBNMKBNMKB-D-UL1+GS2GZBA & 32P-TJQ-R-MBHBH-4J - FES.534661		F2V01&MFS-PNEU_KF1		+ V2AR43UQ43	
Appr										Document type:		Project nr:	
Modification	Date	Name	Original	Replacement of	Replaced by			MPB		22-16152		1	
											275		

# Parts list

F01\_001

Device tag	Quantity	Designation	Type number	Supplier	Part number
=V2AR44UQ41KF1-KF1.0	1	Valve Manifold	51E-F33GCQPNMKBNMKBNMKB-D-UL1+GS2GZBA & 32P-TJQ-R-MBHBH-4J	FES	FES.51E-F33GCQPNMKBNMKBNMKB-D-UL1+GS2GZBA & 32P-TJQ-R-MBHBH-4J
=V2AR44UQ41KF1-KF1.21	0	Subbase	VMPA2-FB-AP-2-1		FES.538000
=V2AR44UQ41KF1-KF1.22	0	Subbase	VMPA2-FB-AP-2-1		FES.538000
=V2AR44UQ41UQ1-QN1	0	Solenoid valve	VMPA2-M1H-J-PI		FES.537953
=V2AR44UQ41UQ1-UQ1.1-FL01	1	One-way flow control valve	GRLA-1/8-QB-1/4-U	FES	FES.534658
=V2AR44UQ41UQ1-UQ1.1-FL02	1	One-way flow control valve	GRLA-1/8-QB-1/4-U	FES	FES.534658
=V2AR44UQ41UQ1-UQ1.2-FL01	1	One-way flow control valve	GRLA-1/8-QB-1/4-U	FES	FES.534658
=V2AR44UQ41UQ1-UQ1.2-FL02	1	One-way flow control valve	GRLA-1/8-QB-1/4-U	FES	FES.534658
=V2AR44UQ41UQ2-QN2	0	Solenoid valve	VMPA2-M1H-J-PI		FES.537953
=V2AR44UQ41UQ2-UQ2.1-FL01	1	One-way flow control valve	GRLA-1/4-QB-1/4-U	FES	FES.534661
=V2AR44UQ41UQ2-UQ2.1-FL02	1	One-way flow control valve	GRLA-1/4-QB-1/4-U	FES	FES.534661
=V2AR44UQ41UQ2-UQ2.2-FL01	1	One-way flow control valve	GRLA-1/4-QB-1/4-U	FES	FES.534661
=V2AR44UQ41UQ2-UQ2.2-FL02	1	One-way flow control valve	GRLA-1/4-QB-1/4-U	FES	FES.534661
=V2AR44UQ41UQ2-UQ2.3-FL01	1	One-way flow control valve	GRLA-1/4-QB-1/4-U	FES	FES.534661
=V2AR44UQ41UQ2-UQ2.3-FL02	1	One-way flow control valve	GRLA-1/4-QB-1/4-U	FES	FES.534661
=V2AR44UQ41UQ3-QN3	0	Solenoid valve	VMPA2-M1H-J-PI		FES.537953
=V2AR44UQ41UQ4-QN4	0	Solenoid valve	VMPA2-M1H-J-PI		FES.537953
=V2AR44UQ41UQ4-UQ4.1-FL01	1	One-way flow control valve	GRLA-1/4-QB-1/4-U	FES	FES.534661
=V2AR44UQ41UQ4-UQ4.1-FL02	1	One-way flow control valve	GRLA-1/4-QB-1/4-U	FES	FES.534661
=V2AR44UQ41UQ4-UQ4.2-FL01	1	One-way flow control valve	GRLA-1/4-QB-1/4-U	FES	FES.534661
=V2AR44UQ41UQ4-UQ4.2-FL02	1	One-way flow control valve	GRLA-1/4-QB-1/4-U	FES	FES.534661
=V2AR44UQ41UQ4-UQ4.3-FL01	1	One-way flow control valve	GRLA-1/4-QB-1/4-U	FES	FES.534661
=V2AR44UQ41UQ4-UQ4.3-FL02	1	One-way flow control valve	GRLA-1/4-QB-1/4-U	FES	FES.534661

+ .AR43UQ43/1

+ .AR44UQ42/1

Date	1/18/2023	Volvo Trucks North America	Valiant TMS	Parts list :	Drawing name:	=	
Ed.	MKLEPADLO	P6700 Framing - Cell 2V01, KF1	Scale 1:1	FES.51E-F33GCQPNMKBNMKBNMKB-D-UL1+GS2GZBA & 32P-TJQ-R-MBHBH-4J - FES.534661	F2V01&MFS-PNEU_KF1	+ V2AR44UQ41	
Appr							Document type:
Modification	Date	Name	Original	Replaced by	MPB	22-16152	1
							275



# Parts list

F01\_001

Device tag	Quantity	Designation	Type number	Supplier	Part number
=V2AR44UQ42KF1-KF1.0	1	Valve Manifold	51E-F33GCQPNMKBNMKBNMKB-D-UL1+GS2GZBA & 32P-TJQ-R-MBHBHBHBHBH-10J	FES	FES.51E-F33GCQPNMKBNMKBNMKB-D-UL1+GS2GZBA & 32P-TJQ-R-MBHBHBHBHBH-10J
=V2AR44UQ42KF1-KF1.21	0	Subbase	VMPA2-FB-AP-2-1		FES.538000
=V2AR44UQ42KF1-KF1.22	0	Subbase	VMPA2-FB-AP-2-1		FES.538000
=V2AR44UQ42KF1-KF1.23	0	Subbase	VMPA2-FB-AP-2-1		FES.538000
=V2AR44UQ42KF1-KF1.24	0	Subbase	VMPA2-FB-AP-2-1		FES.538000
=V2AR44UQ42KF1-KF1.25	0	Subbase	VMPA2-FB-AP-2-1		FES.538000
=V2AR44UQ42UQ1-QN1	0	Solenoid valve	VMPA2-M1H-J-PI		FES.537953
=V2AR44UQ42UQ1-UQ1.1-FL01	1	One-way flow control valve	GRLA-1/8-QB-1/4-U	FES	FES.534658
=V2AR44UQ42UQ1-UQ1.1-FL02	1	One-way flow control valve	GRLA-1/8-QB-1/4-U	FES	FES.534658
=V2AR44UQ42UQ2-QN2	0	Solenoid valve	VMPA2-M1H-J-PI		FES.537953
=V2AR44UQ42UQ2-UQ2.1-FL01	1	One-way flow control valve	GRLA-1/4-QB-1/4-U	FES	FES.534661
=V2AR44UQ42UQ2-UQ2.1-FL02	1	One-way flow control valve	GRLA-1/4-QB-1/4-U	FES	FES.534661
=V2AR44UQ42UQ2-UQ2.2-FL01	1	One-way flow control valve	GRLA-1/4-QB-1/4-U	FES	FES.534661
=V2AR44UQ42UQ2-UQ2.2-FL02	1	One-way flow control valve	GRLA-1/4-QB-1/4-U	FES	FES.534661
=V2AR44UQ42UQ3-QN3	0	Solenoid valve	VMPA2-M1H-J-PI		FES.537953
=V2AR44UQ42UQ4-QN4	0	Solenoid valve	VMPA2-M1H-J-PI		FES.537953
=V2AR44UQ42UQ4-UQ4.1-FL01	1	One-way flow control valve	GRLA-1/4-QB-1/4-U	FES	FES.534661
=V2AR44UQ42UQ4-UQ4.1-FL02	1	One-way flow control valve	GRLA-1/4-QB-1/4-U	FES	FES.534661
=V2AR44UQ42UQ4-UQ4.2-FL01	1	One-way flow control valve	GRLA-1/4-QB-1/4-U	FES	FES.534661
=V2AR44UQ42UQ4-UQ4.2-FL02	1	One-way flow control valve	GRLA-1/4-QB-1/4-U	FES	FES.534661
=V2AR44UQ42UQ5-QN5	0	Solenoid valve	VMPA2-M1H-J-PI		FES.537953
=V2AR44UQ42UQ5-UQ5.1-FL01	1	One-way flow control valve	GRLA-1/4-QB-1/4-U	FES	FES.534661
=V2AR44UQ42UQ5-UQ5.1-FL02	1	One-way flow control valve	GRLA-1/4-QB-1/4-U	FES	FES.534661
=V2AR44UQ42UQ5-UQ5.2-FL01	1	One-way flow control valve	GRLA-1/4-QB-1/4-U	FES	FES.534661
=V2AR44UQ42UQ5-UQ5.2-FL02	1	One-way flow control valve	GRLA-1/4-QB-1/4-U	FES	FES.534661
=V2AR44UQ42UQ6-QN6	0	Solenoid valve	VMPA2-M1H-J-PI		FES.537953
=V2AR44UQ42UQ6-UQ6.1-FL01	1	One-way flow control valve	GRLA-1/4-QB-1/4-U	FES	FES.534661
=V2AR44UQ42UQ6-UQ6.1-FL02	1	One-way flow control valve	GRLA-1/4-QB-1/4-U	FES	FES.534661
=V2AR44UQ42UQ6-UQ6.2-FL01	1	One-way flow control valve	GRLA-1/4-QB-1/4-U	FES	FES.534661
=V2AR44UQ42UQ6-UQ6.2-FL02	1	One-way flow control valve	GRLA-1/4-QB-1/4-U	FES	FES.534661
=V2AR44UQ42UQ6-UQ6.3-FL01	1	One-way flow control valve	GRLA-1/4-QB-1/4-U	FES	FES.534661
=V2AR44UQ42UQ6-UQ6.3-FL02	1	One-way flow control valve	GRLA-1/4-QB-1/4-U	FES	FES.534661
=V2AR44UQ42UQ7-QN7	0	Solenoid valve	VMPA2-M1H-J-PI		FES.537953
=V2AR44UQ42UQ7-UQ7.1-FL01	1	One-way flow control valve	GRLA-1/4-QB-1/4-U	FES	FES.534661
=V2AR44UQ42UQ7-UQ7.1-FL02	1	One-way flow control valve	GRLA-1/4-QB-1/4-U	FES	FES.534661
=V2AR44UQ42UQ7-UQ7.2-FL01	1	One-way flow control valve	GRLA-1/4-QB-1/4-U	FES	FES.534661
=V2AR44UQ42UQ7-UQ7.2-FL02	1	One-way flow control valve	GRLA-1/4-QB-1/4-U	FES	FES.534661
=V2AR44UQ42UQ8-QN8	0	Solenoid valve	VMPA2-M1H-J-PI		FES.537953
=V2AR44UQ42UQ8-UQ8.1-FL01	1	One-way flow control valve	GRLA-1/4-QB-1/4-U	FES	FES.534661
=V2AR44UQ42UQ8-UQ8.1-FL02	1	One-way flow control valve	GRLA-1/4-QB-1/4-U	FES	FES.534661
=V2AR44UQ42UQ8-UQ8.2-FL01	1	One-way flow control valve	GRLA-1/4-QB-1/4-U	FES	FES.534661
=V2AR44UQ42UQ8-UQ8.2-FL02	1	One-way flow control valve	GRLA-1/4-QB-1/4-U	FES	FES.534661
=V2AR44UQ42UQ9-QN9	0	Solenoid valve	VMPA2-M1H-J-PI		FES.537953
=V2AR44UQ42UQ9-UQ9.1-FL01	1	One-way flow control valve	GRLA-1/4-QB-1/4-U	FES	FES.534661
=V2AR44UQ42UQ9-UQ9.1-FL02	1	One-way flow control valve	GRLA-1/4-QB-1/4-U	FES	FES.534661
=V2AR44UQ42UQ9-UQ9.2-FL01	1	One-way flow control valve	GRLA-1/4-QB-1/4-U	FES	FES.534661
=V2AR44UQ42UQ9-UQ9.2-FL02	1	One-way flow control valve	GRLA-1/4-QB-1/4-U	FES	FES.534661
=V2AR44UQ42UQ10-QN10	0	Solenoid valve	VMPA2-M1H-J-PI		FES.537953

+ .AR44UQ41/1

+ .AR44UQ43/1

Date	1/18/2023	Volvo Trucks North America	Valiant TMS	Parts list :	Drawing name:	=	
Ed.	MKLEPADLO	P6700 Framing - Cell 2V01, KF1	Scale 1:1	FES.51E-F33GCQPNMKBNMKBNMKB-D-UL1+GS2GZBA & 32P-TJQ-R-MBHBHBHBHBH-10J - FES.537953	F2V01&MFS-PNEU_KF1	+ V2AR44UQ42	
Appr							Document type:
Modification	Date	Name	Original	Replaced by	MPB	22-16152	1
							275



# Parts list

F01\_001

Device tag	Quantity	Designation	Type number	Supplier	Part number
=V2GL15UQ51KF2-KF2.0	1	Valve Manifold	51E-F33GCQPNMKBNMKBNMKB-S-UL1+GS2GZBA & 45PN-R-Z-LSMX-BBU-4J	FES	FES.51E-F33GCQPNMKBNMKBNMKB-S-UL1+GS2GZBA & 45PN-R-Z-LSMX-BBU-4J
=V2GL15UQ51KF2-KF2.21	0	Manifold subbase	VABV-S4-1HS-N14-2T2		FES.546213
=V2GL15UQ51KF2-KF2.22	0	Manifold subbase	VABV-S4-1HS-N14-2T2		FES.546213
=V2GL15UQ51UQ3-QN1	0	Solenoid valve	VSVA-B-B52-ZD-A1-1T1L	FES	FES.539156
=V2GL15UQ51UQ3-UQ3.1-FL01	1	One-way flow control valve	GRLA-1/4-QB-3/8-U		FES.534663
=V2GL15UQ51UQ3-UQ3.1-FL02	1	One-way flow control valve	GRLA-1/4-QB-3/8-U		FES.534663
=V2GL15UQ51UQ4-QN2	0	Solenoid valve	VSVA-B-B52-ZD-A1-1T1L	FES	FES.539156
=V2GL15UQ51UQ4-UQ4.1-FL01	1	One-way flow control valve	GRLA-1/4-QB-3/8-U		FES.534663
=V2GL15UQ51UQ4-UQ4.1-FL02	1	One-way flow control valve	GRLA-1/4-QB-3/8-U		FES.534663
=V2GL15UQ51UQ5-QN3	0	Solenoid valve	VSVA-B-B52-ZD-A1-1T1L	FES	FES.539156
=V2GL15UQ51UQ5-UQ5.1-FL01	1	One-way flow control valve	GRLA-1/4-QB-3/8-U		FES.534663
=V2GL15UQ51UQ5-UQ5.1-FL02	1	One-way flow control valve	GRLA-1/4-QB-3/8-U		FES.534663
=V2GL15UQ51UQ8-QN4	0	Solenoid valve	VSVA-B-B52-ZD-A1-1T1L	FES	FES.539156

+ .AR44UQ43/1

+ .GL16UQ51/1











# Parts list

F01\_001

Device tag	Quantity	Designation	Type number	Supplier	Part number
=V2UQ31KF1-KF1.0	1	Valve Manifold	51E-F33GCQPNMKBNMKB-S-UL1+GS2GZBA & 45PN-R-Z-LSMX-5BU-9JL	FES	FES.51E-F33GCQPNMKBNMKB-S-UL1+GS2GZBA & 45PN-R-Z-LSMX-5BU-9JL
=V2UQ31KF1-KF1.21	0	Manifold subbase	VABV-S4-1HS-N14-2T2		FES.546213
=V2UQ31KF1-KF1.22	0	Manifold subbase	VABV-S4-1HS-N14-2T2		FES.546213
=V2UQ31KF1-KF1.23	0	Manifold subbase	VABV-S4-1HS-N14-2T2		FES.546213
=V2UQ31KF1-KF1.24	0	Manifold subbase	VABV-S4-1HS-N14-2T2		FES.546213
=V2UQ31KF1-KF1.25	0	Manifold subbase	VABV-S4-1HS-N14-2T2		FES.546213
=V2UQ31KF2-KF2.0	1	Valve Manifold	51E-F33GCQPNMKBNMKB-S-UL1+GS2GZBA & 45PN-R-Z-LSMX-5BU-9JL	FES	FES.51E-F33GCQPNMKBNMKB-S-UL1+GS2GZBA & 45PN-R-Z-LSMX-5BU-9JL
=V2UQ31KF2-KF2.21	0	Manifold subbase	VABV-S4-1HS-N14-2T2		FES.546213
=V2UQ31KF2-KF2.22	0	Manifold subbase	VABV-S4-1HS-N14-2T2		FES.546213
=V2UQ31KF2-KF2.23	0	Manifold subbase	VABV-S4-1HS-N14-2T2		FES.546213
=V2UQ31KF2-KF2.24	0	Manifold subbase	VABV-S4-1HS-N14-2T2		FES.546213
=V2UQ31KF2-KF2.25	0	Manifold subbase	VABV-S4-1HS-N14-2T2		FES.546213
=V2UQ31UQ1-QN1	0	Solenoid valve	VSVA-B-B52-ZD-A1-1T1L	FES	FES.539156
=V2UQ31UQ1-UQ1.1-FL01	1	One-way flow control valve	GRLA-1/4-QB-3/8-U		FES.534663
=V2UQ31UQ1-UQ1.1-FL02	1	One-way flow control valve	GRLA-1/4-QB-3/8-U		FES.534663
=V2UQ31UQ1-UQ1.2-FL01	1	One-way flow control valve	GRLA-1/4-QB-3/8-U		FES.534663
=V2UQ31UQ1-UQ1.2-FL02	1	One-way flow control valve	GRLA-1/4-QB-3/8-U		FES.534663
=V2UQ31UQ1-UQ1.3-FL01	1	One-way flow control valve	GRLA-1/4-QB-3/8-U		FES.534663
=V2UQ31UQ1-UQ1.3-FL02	1	One-way flow control valve	GRLA-1/4-QB-3/8-U		FES.534663
=V2UQ31UQ2-QN2	0	Solenoid valve	VSVA-B-B52-ZD-A1-1T1L	FES	FES.539156
=V2UQ31UQ2-UQ2.1-FL01	1	One-way flow control valve	GRLA-1/4-QB-3/8-U		FES.534663
=V2UQ31UQ2-UQ2.1-FL02	1	One-way flow control valve	GRLA-1/4-QB-3/8-U		FES.534663
=V2UQ31UQ3-QN3	0	Solenoid valve	VSVA-B-B52-ZD-A1-1T1L	FES	FES.539156
=V2UQ31UQ3-UQ3.1-FL01	1	One-way flow control valve	GRLA-1/4-QB-3/8-U		FES.534663
=V2UQ31UQ3-UQ3.1-FL02	1	One-way flow control valve	GRLA-1/4-QB-3/8-U		FES.534663
=V2UQ31UQ4-QN4	0	Solenoid valve	VSVA-B-B52-ZD-A1-1T1L	FES	FES.539156
=V2UQ31UQ4-UQ4.1-FL01	1	One-way flow control valve	GRLA-1/4-QB-3/8-U		FES.534663
=V2UQ31UQ4-UQ4.1-FL02	1	One-way flow control valve	GRLA-1/4-QB-3/8-U		FES.534663
=V2UQ31UQ5-QN5	0	Solenoid valve	VSVA-B-B52-ZD-A1-1T1L	FES	FES.539156
=V2UQ31UQ5-UQ5.1-FL01	1	One-way flow control valve	GRLA-1/4-QB-3/8-U		FES.534663
=V2UQ31UQ5-UQ5.1-FL02	1	One-way flow control valve	GRLA-1/4-QB-3/8-U		FES.534663
=V2UQ31UQ6-QN6	0	Solenoid valve	VSVA-B-B52-ZD-A1-1T1L	FES	FES.539156
=V2UQ31UQ6-UQ6.1-FL01	1	One-way flow control valve	GRLA-1/4-QB-3/8-U		FES.534663
=V2UQ31UQ6-UQ6.1-FL02	1	One-way flow control valve	GRLA-1/4-QB-3/8-U		FES.534663
=V2UQ31UQ7-QN7	0	Solenoid valve	VSVA-B-B52-ZD-A1-1T1L	FES	FES.539156
=V2UQ31UQ7-UQ7.1-FL01	1	One-way flow control valve	GRLA-1/4-QB-3/8-U		FES.534663
=V2UQ31UQ7-UQ7.1-FL02	1	One-way flow control valve	GRLA-1/4-QB-3/8-U		FES.534663
=V2UQ31UQ8-QN8	0	Solenoid valve	VSVA-B-B52-ZD-A1-1T1L	FES	FES.539156
=V2UQ31UQ8-UQ8.1-FL01	1	One-way flow control valve	GRLA-1/4-QB-3/8-U		FES.534663
=V2UQ31UQ8-UQ8.1-FL02	1	One-way flow control valve	GRLA-1/4-QB-3/8-U		FES.534663
=V2UQ31UQ9-QN9	0	Solenoid valve	VSVA-B-B52-ZD-A1-1T1L	FES	FES.539156
=V2UQ31UQ9-UQ9.1-FL01	1	One-way flow control valve	GRLA-1/4-QB-3/8-U		FES.534663
=V2UQ31UQ9-UQ9.1-FL02	1	One-way flow control valve	GRLA-1/4-QB-3/8-U		FES.534663
=V2UQ31UQ10-QN10	0	Solenoid valve	VSVA-B-B52-ZD-A1-1T1L	FES	FES.539156
=V2UQ31UQ10-UQ10.1-FL01	1	One-way flow control valve	GRLA-1/4-QB-3/8-U		FES.534663
=V2UQ31UQ10-UQ10.1-FL02	1	One-way flow control valve	GRLA-1/4-QB-3/8-U		FES.534663
=V2UQ31UQ10-UQ10.2-FL01	1	One-way flow control valve	GRLA-1/4-QB-3/8-U		FES.534663
=V2UQ31UQ10-UQ10.2-FL02	1	One-way flow control valve	GRLA-1/4-QB-3/8-U		FES.534663
=V2UQ31UQ10-UQ10.3-FL01	1	One-way flow control valve	GRLA-1/4-QB-3/8-U		FES.534663
=V2UQ31UQ10-UQ10.3-FL02	1	One-way flow control valve	GRLA-1/4-QB-3/8-U		FES.534663
=V2UQ31UQ11-QN11	0	Solenoid valve	VSVA-B-B52-ZD-A1-1T1L	FES	FES.539156
=V2UQ31UQ11-UQ11.1-FL01	1	One-way flow control valve	GRLA-1/4-QB-3/8-U		FES.534663
=V2UQ31UQ11-UQ11.1-FL02	1	One-way flow control valve	GRLA-1/4-QB-3/8-U		FES.534663
=V2UQ31UQ12-QN12	0	Solenoid valve	VSVA-B-B52-ZD-A1-1T1L	FES	FES.539156
=V2UQ31UQ12-UQ12.1-FL01	1	One-way flow control valve	GRLA-1/4-QB-3/8-U		FES.534663
=V2UQ31UQ12-UQ12.1-FL02	1	One-way flow control valve	GRLA-1/4-QB-3/8-U		FES.534663

+ .GL18UQ51/1

2

Date	1/18/2023	Volvo Trucks North America	Valiant TMS	Parts list :	Drawing name:	=	
Ed.	MKLEPADLO	P6700 Framing - Cell 2V01, KF1	Scale 1:1	FES.51E-F33GCQPNMKBNMKB-S-UL1+GS2GZBA & 45PN-R-Z-LSMX-5BU-9JL - FES.534663	=2V01&MFS-PNEU_KF1	+ V2UQ31	
Appr							Document type:
Modification	Date	Name	Original	Replaced by	MPB	22-16152	1
							275

# Parts list

F01\_001

Device tag	Quantity	Designation	Type number	Supplier	Part number
=V2UQ31UQ13-QN13	0	Solenoid valve	VSVA-B-B52-ZD-A1-1T1L	FES	FES.539156
=V2UQ31UQ13-UQ13.1-FL01	1	One-way flow control valve	GRLA-1/4-QB-3/8-U		FES.534663
=V2UQ31UQ13-UQ13.1-FL02	1	One-way flow control valve	GRLA-1/4-QB-3/8-U		FES.534663
=V2UQ31UQ14-QN14	0	Solenoid valve	VSVA-B-B52-ZD-A1-1T1L	FES	FES.539156
=V2UQ31UQ14-UQ14.1-FL01	1	One-way flow control valve	GRLA-1/4-QB-3/8-U		FES.534663
=V2UQ31UQ14-UQ14.1-FL02	1	One-way flow control valve	GRLA-1/4-QB-3/8-U		FES.534663
=V2UQ31UQ15-QN15	0	Solenoid valve	VSVA-B-B52-ZD-A1-1T1L	FES	FES.539156
=V2UQ31UQ15-UQ15.1-FL01	1	One-way flow control valve	GRLA-1/4-QB-3/8-U		FES.534663
=V2UQ31UQ15-UQ15.1-FL02	1	One-way flow control valve	GRLA-1/4-QB-3/8-U		FES.534663
=V2UQ31UQ16-QN16	0	Solenoid valve	VSVA-B-B52-ZD-A1-1T1L	FES	FES.539156
=V2UQ31UQ16-UQ16.1-FL01	1	One-way flow control valve	GRLA-1/4-QB-3/8-U		FES.534663
=V2UQ31UQ16-UQ16.1-FL02	1	One-way flow control valve	GRLA-1/4-QB-3/8-U		FES.534663
=V2UQ31UQ17-QN17	0	Solenoid valve	VSVA-B-B52-ZD-A1-1T1L	FES	FES.539156
=V2UQ31UQ17-UQ17.1-FL01	1	One-way flow control valve	GRLA-1/4-QB-3/8-U		FES.534663
=V2UQ31UQ17-UQ17.1-FL02	1	One-way flow control valve	GRLA-1/4-QB-3/8-U		FES.534663
=V2UQ31UQ18-QN18	0	Solenoid valve	VSVA-B-B52-ZD-A1-1T1L	FES	FES.539156
=V2UQ31UQ18-UQ18.1-FL01	1	One-way flow control valve	GRLA-1/4-QB-3/8-U		FES.534663
=V2UQ31UQ18-UQ18.1-FL02	1	One-way flow control valve	GRLA-1/4-QB-3/8-U		FES.534663
=V2UQ31UQ19-QN19	0	Blanking plate	VABB-S4-1-WT		FES.539212
=V2UQ31UQ20-QN20	0	Blanking plate	VABB-S4-1-WT		FES.539212

1