

Installation and Maintenance

Tool changers Moduflex-series

M0720-1

Tool changers | Swivels | Swivels with Tool changers | Grippers | Hose packages | Valve Units | Tool systems

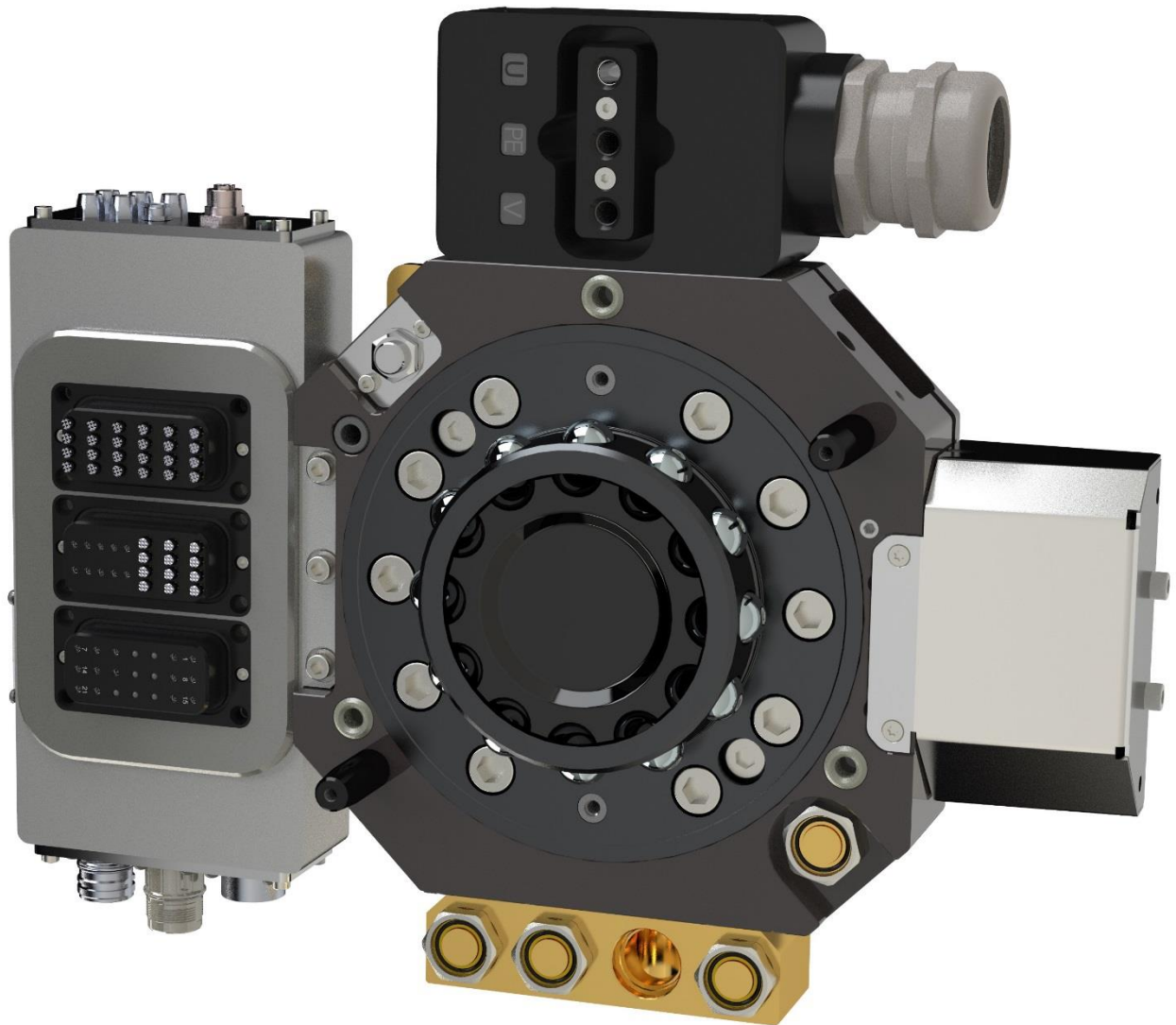

The information in this document is subject to change without prior notice and should not be regarded as an undertaking from Robot System Products AB. Robot System Products AB assumes no responsibility for errors that may occur in this document.

Robot System Products AB bears no responsibility for damage that is incurred by the use of this document, or the software or hardware described in this document.

The document, or parts of it, may not be reproduced or copied without prior permission from Robot System Products AB. It may neither be imparted to a third party, nor otherwise be used without authorization. Infringement hereof will be subject to action in accordance with the applicable laws.

Further copies of this document can be obtained from Robot System Products AB at current prices.

© Robot System Products AB

Robot Systems Products AB
Isolatorvägen 4
SE-721 37 Västerås
Sweden

CONTENTS

1 INTRODUCTION.....	6
1.1 Installation and Maintenance manual	6
1.2 Safety	7
1.2.1 General	7
1.2.2 Explanation of warnings.....	7
1.3 Tightening torques	8
1.4 Recommended equipment.....	8
1.5 Required products.....	9
2 INSTALLATION.....	10
2.1 Installation of tool changer on robot	10
2.2 Installation of tool attachment to tool	11
2.3 Mounting of cable/cables in weld power connectors, P6716/P6784 and P6726.....	14
2.4 Mounting of electric modules on tool changer or tool attachment	16
2.5 Mounting of water/air modules on tool changer or tool attachment.....	17
2.6 Mounting of integrated valve, P7710	18
2.7 Mounting of TC ground socket, P7239	20
2.8 Mounting of TA ground socket, P7147	21
3 TC OPERATION AND INTERFACE	22
3.1 Software function with RSP integrated safety module	22
3.2 Software function without RSP integrated safety module	22
3.3 Sparking	25
3.4 Programming.....	25
3.5 Tool Stand	25
3.6 Tool Identification	25
4 MAINTENANCE AND SERVICE	26
4.1 Maintenance scheme	26
4.1.1 Every second week	26
4.1.2 Every three-months or every 125,000 tool changes	26
4.1.3 Every six-months or after every 250,000 tool changes	27
4.1.4 To replace when damaged or worn-out.....	27
4.2 Specification of maintenance activities.....	28
4.2.1 Visual inspection of tool changer (every 2nd week)	28
4.2.2 Visual inspection and cleaning of tool attachment (every 2nd week)	30
4.2.3 Cleaning and lubrication of TC (every 3rd month or 125,000 tool changes)	32
4.2.4 Cleaning and lubrication of tool attachment (every 3rd month or 125,000 tool changes)	33
4.2.5 Cleaning and lubrication of TC (every 6 th month or 250,000 tool changes)	34
4.2.6 Cleaning and lubrication of tool attachment (every 6th month or 250,000 tool changes)	36
5 MANUAL UNLOCKING OF TOOL CHANGER	38
5.1 Manual unlocking	38
5.2 Forced manual unlocking, P6910	39

6 DISMOUNTING AND REPLACEMENT	41
6.1 Replacement of tool changer	41
6.2 Replacement of tool attachment	43
6.3 Replacement of wear parts	45
6.3.1 Replacement of dampers on tool changers.....	45
6.3.2 Replacement of guide pins on tool changers	46
6.3.3 Replacement of guide bushings on tool attachments.....	48
6.3.4 Replacement of spring-loaded signal pins	49
6.3.5 Replacement of water/air couplings	50
6.3.6 Replacement of weld power sockets	52
6.3.7 Replacement of weld power pins	55
6.3.8 Replacement of air sealings	58
6.3.9 Replacement of O-rings on signal modules.....	59
6.3.10 Replacement of electric modules on tool changer or tool attachment	60
6.3.11 Replacement of water/air modules on tool changer or tool attachment	61
7 DISPOSAL AND RECYCLING.....	62

1 INTRODUCTION

Robot System Products is a front-rank provider of peripheral products for high performance robot applications. We provide complete tool systems solutions for your robot installations, aiming to improve your productivity with the most reliable and cost-effective tooling on the market. Continuously we explore emerging technologies, working with leading edge design.

Robot System Products has a wide range of standard robot peripheral products:

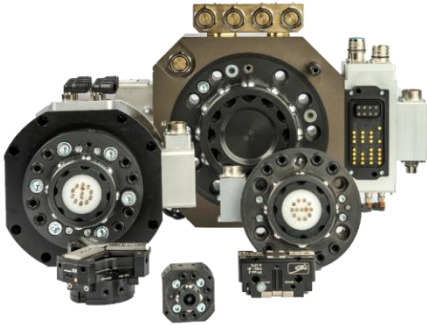

- Tool changers
- Swivels
- Swivel tool changers
- CiRo
- Grippers
- Hose Packages
- Valve units
- Tool systems
- Tool parking systems

Robot System Products' tool changers are constructed to maximize the flexibility and reliability of your robot fleet. Through our patented locking device TrueConnect™ robustness and high safety are combined with low weight and compactness. With our swivels compressed air, water, electrical and data signals as well as weld and servo power are transferred to your tools with robot motion capabilities fully maintained. Our Swivel tool changers unite the TrueConnect™ mechanism with our swivel technology, combining the best out of the two technologies. With RSPs unique Circular Rotators cables and hoses can be freely selected with high robot flexibility maintained, and the space requirements reduced. Our integrated tool systems are delivered as complete plug-and-play solutions designed for quick and simple installation.

Robot System Products' product lines are available for all major robot brands and come with complete documentation. 3D-models for simulation are available for download at:

www.rsp.eu.com

1.1 Installation and Maintenance manual

This document describes how the Moduflex group of tools changers, TC240, TC480, TC720 and TC960, including corresponding tool attachments and options for transfer of power, signals, water and air are installed and replaced. In addition, the document describes required maintenance activities, including inspection, cleaning, lubrication, replacement of wear parts, required tools and products and disposal and recycling.

The document, *Product Description* (M0723-1) contains general product information, drawings, technical data, electrical and pneumatic diagrams, safety software function and lists of spare parts.

1.2 Safety

1.2.1 General

The integrator installing the tool changer into the system must follow the safety demands stated in standards and provisions applicable in the country where the tool changer system is to be installed. The products are all prepared for CE-certification.

The user of the Robot System Products tool changer is responsible that law and directives applicable in respective countries, with regards to safety, are followed. The user is also responsible to guarantee that all safety devices are installed correctly.



WARNING!

Never carry out service work on a robot that has not been taken out of operation. See safety information for the robot.



WARNING!

Only perform work on grippers or tools attached to the tool changer if the air pressure is safely switched off.



WARNING!

Be aware that tool changer and tool attachment are heavy and may cause personal injury and equipment damage if dropped.



NOTE!

The tool changer shall always be in locked position, also when empty, to avoid unexpected locking if air pressure is lost.



NOTE!

For the tool changer to comply with international safety standards like ISO 13849 and ISO 10218, double channel technology is required for control and supervision, using valves like P6718 or P7710.

1.2.2 Explanation of warnings

The warnings in this document are specific to the products in this manual. It is expected that the user also pay attention to certain notifications from the robot manufacturer and/or the manufacturers of other components used in the installation.



WARNING!

The warning sign will make you aware that a situation could result in potential serious injury or damage to equipment.



NOTE!

The note sign will alert you about something important to consider.

1.3 Tightening torques

Tightening torques for mounting (screw class 8.8)

Dimension	Torque
M4	3 Nm
M5	6 Nm
M6	10 Nm
M8	24 Nm
M10	47 Nm
M12	82 Nm
M16	200 Nm

Tightening torques for mounting (screw class 12.9)

Dimension	Torque
M8	41 Nm
M10	79 Nm
M12	138 Nm
M14	221 Nm
M16	338 Nm

1.4 Recommended equipment

Equipment recommended for installation and maintenance work

Tools	Applications
Complete set of Allen keys	For all socket head cap screws
Torque wrench	For dismounting and mounting
Torx key	For dismounting and mounting
Pair of pliers	For dismounting the signal pins.
27mm socket wrench	For dismounting water/air couplings
Guide pin puller (VA0178.004)	For dismounting the guide pins
2 x 16 mm spanners	For dismounting the guide pins
Screw driver	For removing the air sealings.

1.5 Required products

Products required for installation and maintenance work

Product	Specification	Note
Grease, 3HXG1000-413	Magnalube-G, Teflon grease	For air sealings and water/air couplings.
Grease 3HXG1000-262	Electrolube SGB Contact Treatment Grease	For weld and servo power sockets.
Grease I0876	Molykote BR2Plus	For guide pins, guide bushings and locking balls.
Cleaning agent	Industrial alcohol or similar	For cleaning of tool changer and tool attachment.
Glue	Loctite 638 (or similar)	For gluing the guide pins and guide bushings.
Cloth	Lint free cloth	For cleaning.



NOTE! Chemical resistance protective gloves are recommended when using grease or cleaning agents such as industrial alcohol. Safety goggles are recommended when working with cleaning agents such as industrial alcohol. Adequate ventilation should be provided when chemical substances are used.

2 INSTALLATION

2.1 Installation of tool changer on robot

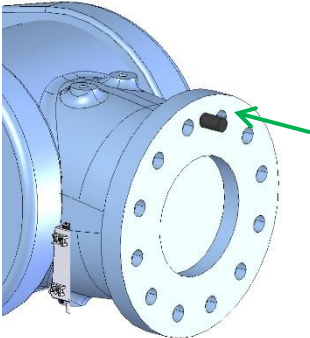
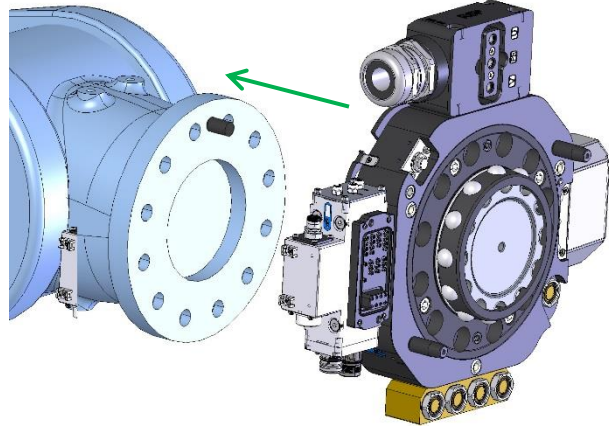
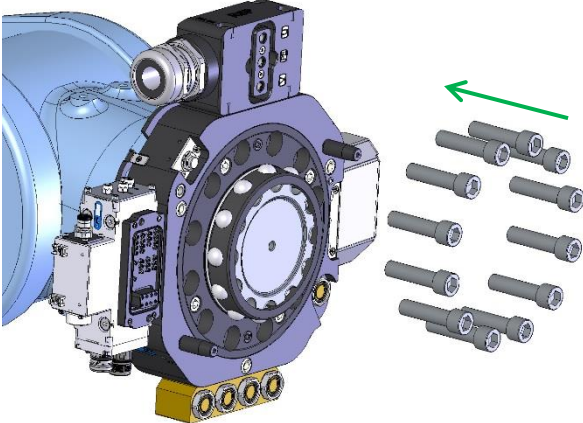

	Action	Note
1	Safety	Read the safety section (1.2)
2	Service position	Place the robot in service position
3	Power off	Switch the power off and lock the circuit breaker. NOTE! Read the safety chapter for the robot.
4	Mount guide pin 	Press the enclosed guide pin into its position on the robot flange. <i>Alternatively, if adaptation plate is used:</i> Mount the adaptation plate on the robot flange (see tightening torques above). Press the enclosed guide pin into the adaptation plate.
5	Fit tool changer 	Lift the tool changer to the robot flange (or adaptation plate). Make sure the guide pin is fitted to the guide hole in the tool changer. WARNING! The tool changer is heavy and may cause personal injury and equipment damage if dropped.
6	Mount tool changer 	Mount the tool changer with the enclosed screws using a torque wrench (see tightening torques above).

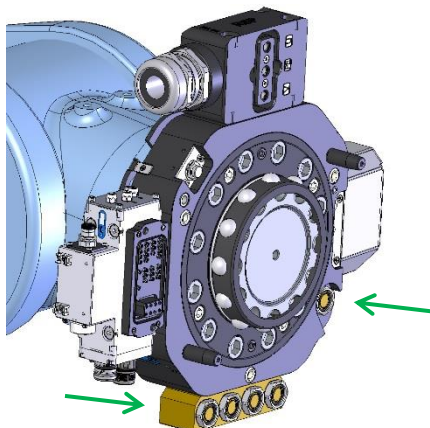
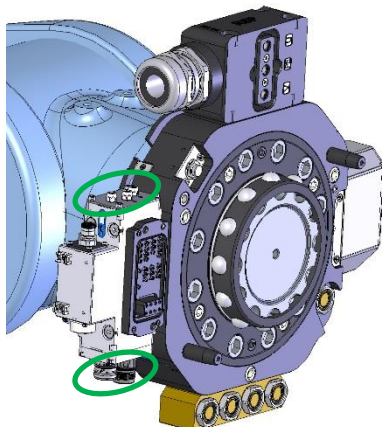
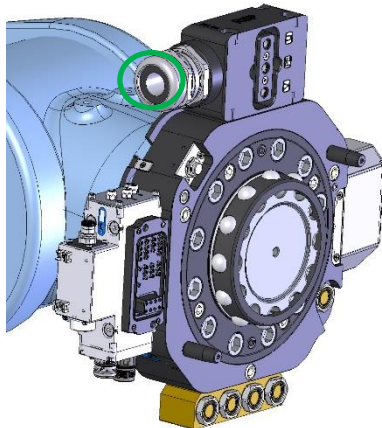

7	<p>Connect air and water</p> 	<p>Connect air and water hoses to the hose fittings. Ensure they are tightly attached with securing straps.</p> <p>Pneumatic diagrams are found in the product description of respective unit.</p>
8	<p>Connect signals</p> 	<p>Connect electrical connectors and field bus in accordance with selected options.</p> <p>Circuit diagrams are found in the product description of respective unit.</p>
9	<p>Connect weld power (SW-versions only)</p> 	<p>Mount cable/cables or MC connector in the weld power connector.</p> <p>NOTE! The module can be mounted in two ways, with cable/connector to the right or left.</p>
10	<p>Power on</p>	<p>Unlock circuit breaker and switch power on.</p>

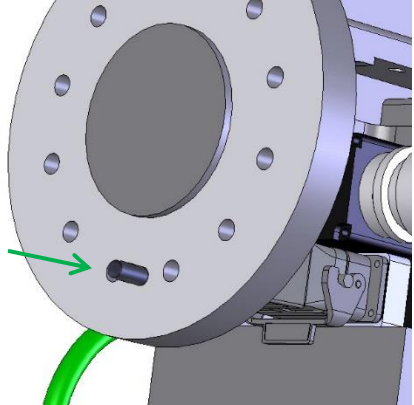
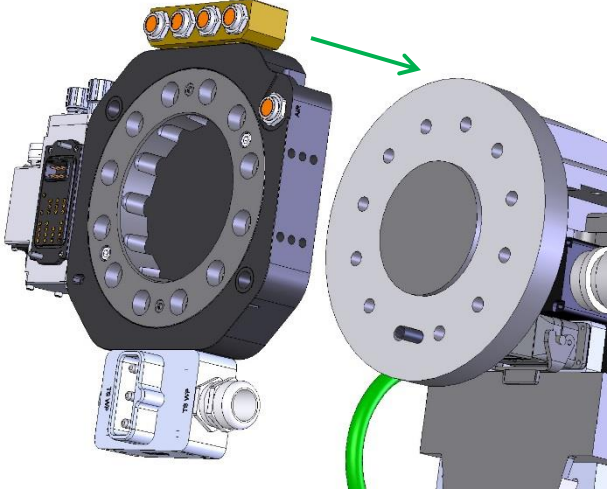
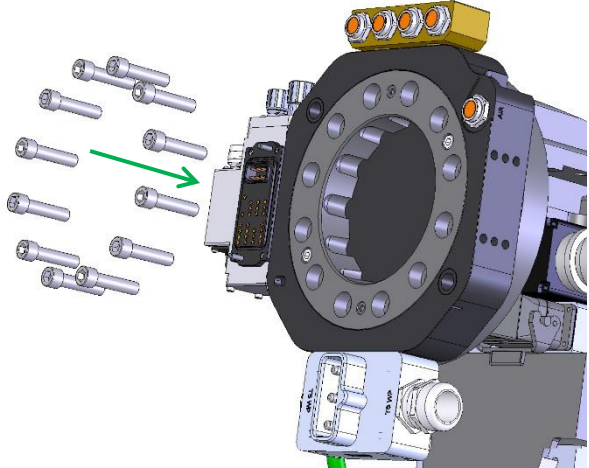

2.2 Installation of tool attachment to tool

	Action	Note
1	Safety	Read the safety section (1.2).
2	Mount guide pin 	Press a guide pin into its position on the tool.
3	Fit the tool attachment 	Lift and fit the tool attachment with the tool. Make sure the guide pin is fitted to the guide hole in the tool.
4	Mount the attachment on the tool 	Mount the tool attachment using a torque wrench. NOTE! Mounting can be made either from the tool attachment side or the gripper/tool side. Screws are specified in the product description of respective unit. See tightening torques above.





5 **Connect air and water hoses**

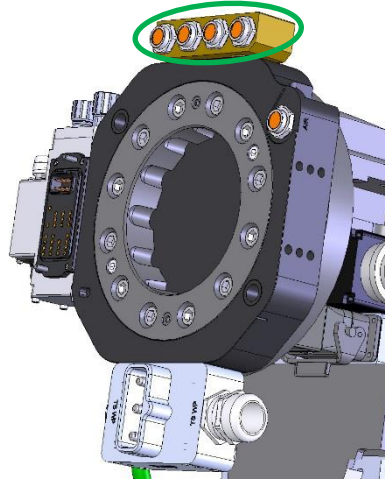

Connect air and water hoses to the hose fittings.

NOTE! Water forward and return must be connected in accordance with corresponding connections on the robot side. Pneumatic diagrams are found in the product description of respective unit.

6 **Connect signals**

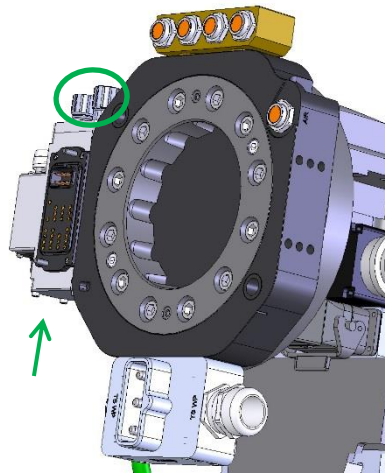

Connect electrical connectors and field bus in accordance with selected options.

Circuit diagrams are found in the product description of respective unit.

7 **Connect weld power (SW-versions only)**

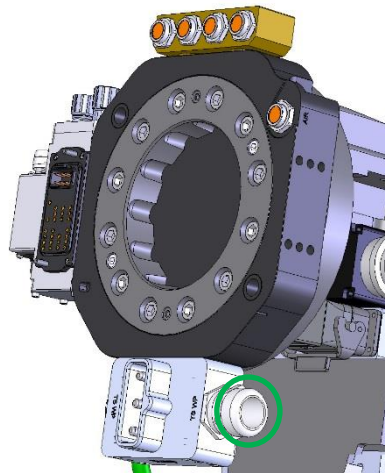



Mount the module with the provided screws. Tighten with a torque of 24 Nm.

NOTE! The module can be mounted in two ways, with cable to the right or left.

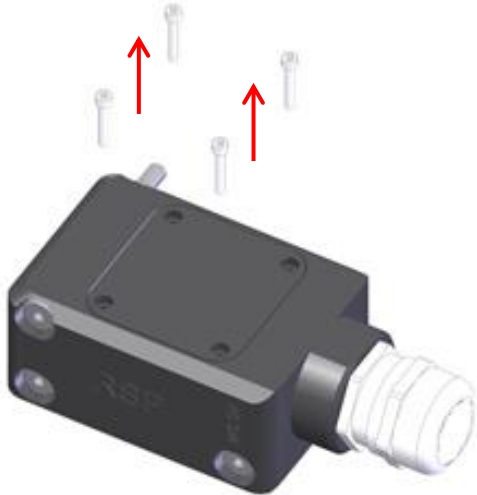
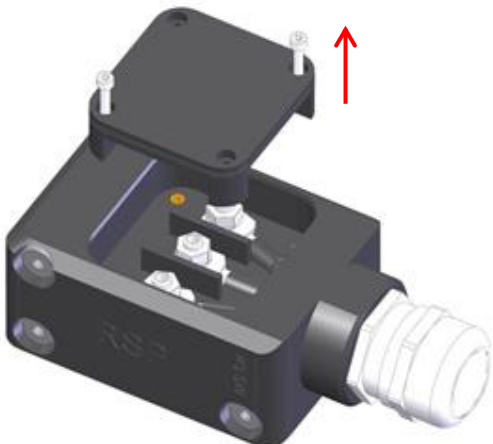

2.3 Mounting of cable/cables in weld power connectors, P6716/P6784 and P6726

	Action	Note
1	<p>Remove screws</p> 	<p>Remove the four M4x25 screws or M5x30 screws (depending on unit), on the rear side of the weld power connector holding the cover.</p>
2	<p>Remove cover</p> 	<p>Insert two M5 screws respective M6 screws (depending on unit), in the screw holes to facilitate removal of the cover.</p>
3	<p>Remove nuts</p> 	<p>Unscrew and remove the three M8 nuts and the washers.</p>



4

Mount cable

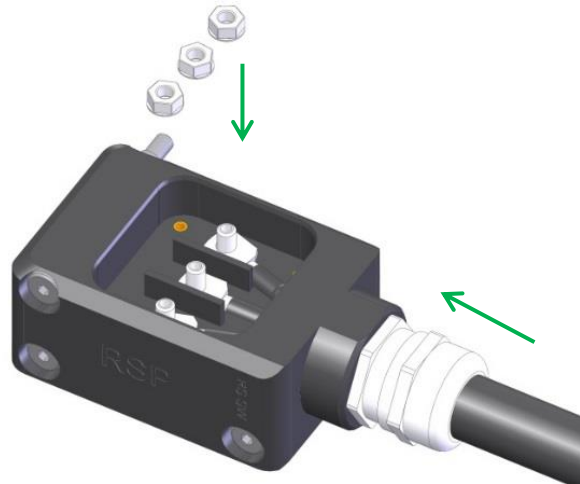

Insert weld cable/cables and mount the cable lugs with washers and M8 nuts.

NOTE! PE shall be in the centre. The other two, U and V, are free to place. Place marking labels accordingly.

NOTE!
Maximum torque for the M8 nuts are 6 Nm.

5

Mount rear cover

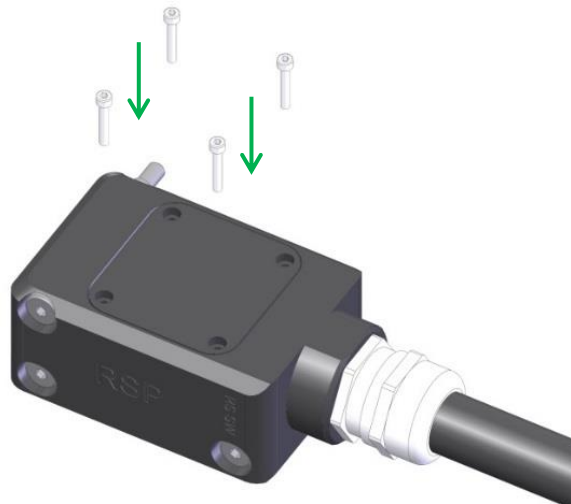

Mount the rear cover using the four M4x25 screws or M5x30 screws (depending on unit). Apply a small amount of grease (Electrolube SGB) inside the weld power sockets.

NOTE!
Be careful not to damage the O-ring seal.



2.4 Mounting of electric modules on tool changer or tool attachment

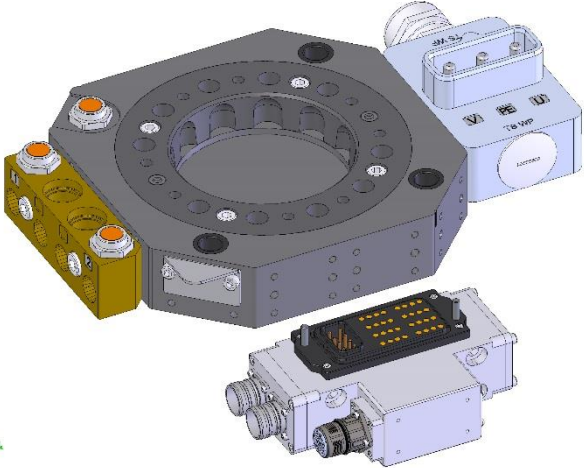
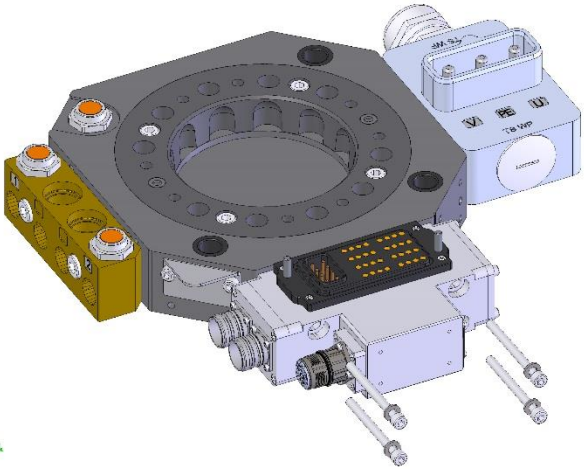
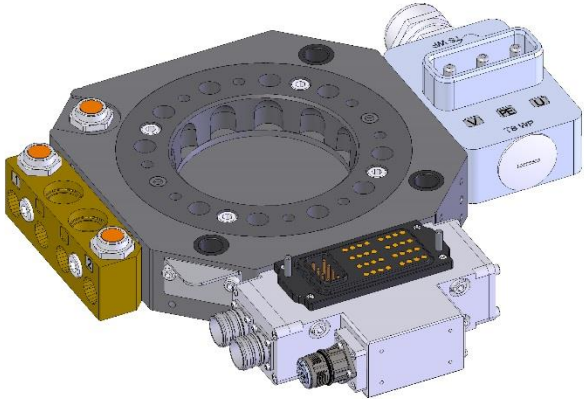

	Action	Note
1	Fit module 	<p>Fit the signal, field bus, servo power and/or weld power module the tool changer/tool attachment.</p> <p>NOTE! When guide pins are used make sure they are fitted to the corresponding guide holes in the tool changer/tool attachment.</p>
2	Mount module 	<p>Mount the module with the four enclosed M6-screws using a torque wrench (see tightening torques above).</p>
3	Connect signals 	<p>Connect electrical connectors and field bus in accordance with selected option.</p> <p>NOTE! Circuit diagrams are found in the product description of respective unit.</p>





2.5 Mounting of water/air modules on tool changer or tool attachment

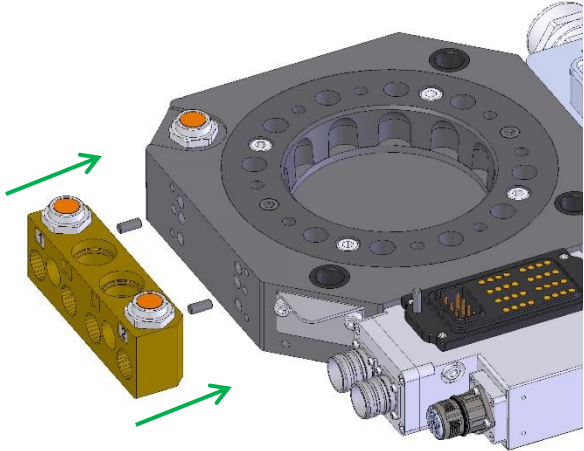
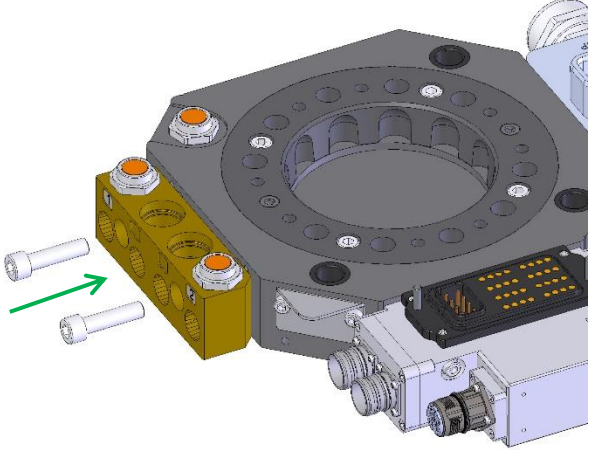
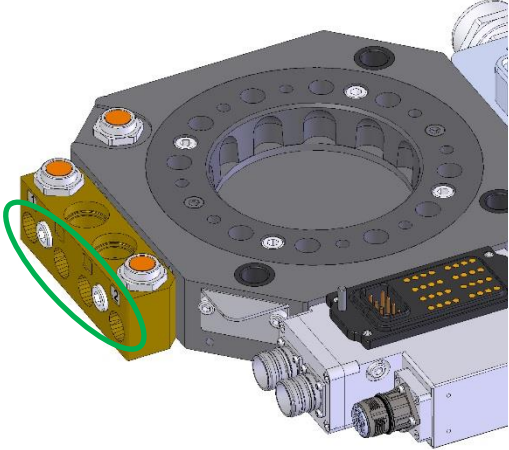

	Action	Note
1	Fit module 	Fit the water/air module to the tool changer/tool attachment. NOTE! When guide pins are used make sure they are fitted to the corresponding guide holes in the tool changer/tool attachment.
2	Mount module 	Mount the module with the two enclosed M10-screws using a torque wrench (see tightening torques above).
3	Connect air/water 	Connect air and water hoses to the hose fittings in accordance with selected option. NOTE! Pneumatic diagrams are found in the product description of respective unit.

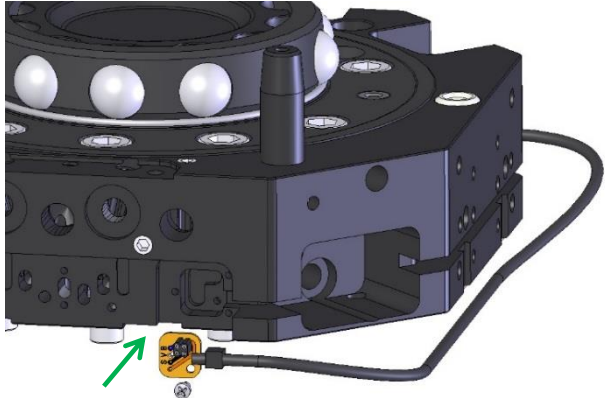

2.6 Mounting of integrated valve, P7710

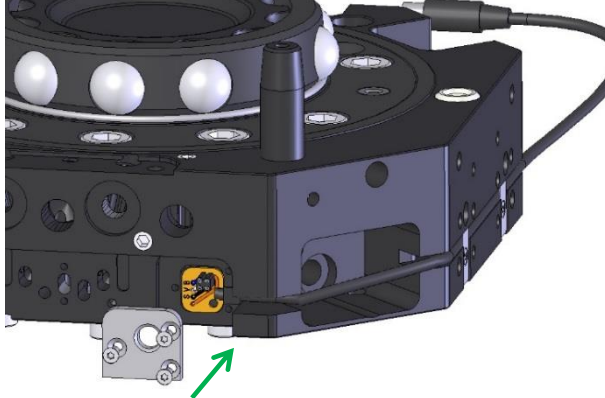
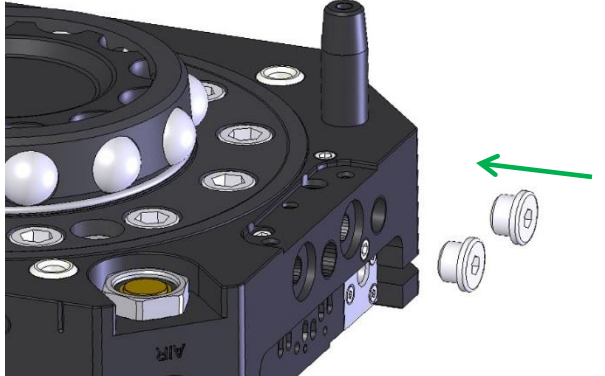
	Action	Note
1	<p>Mount circuit board</p> 	<p>Mount the circuit board with the enclosed M3x6 screw.</p>
2	<p>Mount cable</p> 	<p>Mount the cable with the cable tray cover mounted on the tool changer. Fasten with the two M3x6 screws.</p> <p>NOTE! The two M3 screws must be loosened before the cable is mounted.</p> <p>NOTE! Ensure that the cable is not squeezed by the cover.</p>
3	<p>Mount valve connector cover</p> 	<p>Mount the valve connector cover with three M3x8 screws.</p>
4	<p>Mount blind plugs</p> 	<p>Insert and mount two blind plugs.</p>

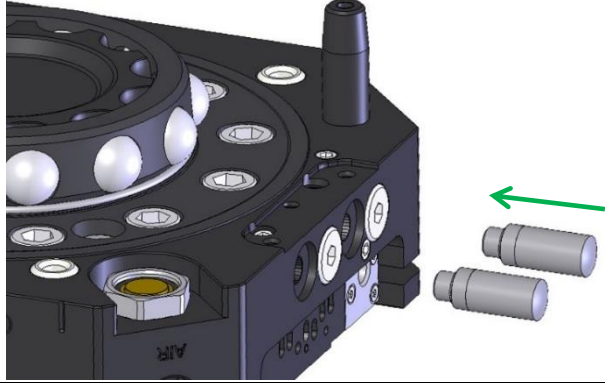
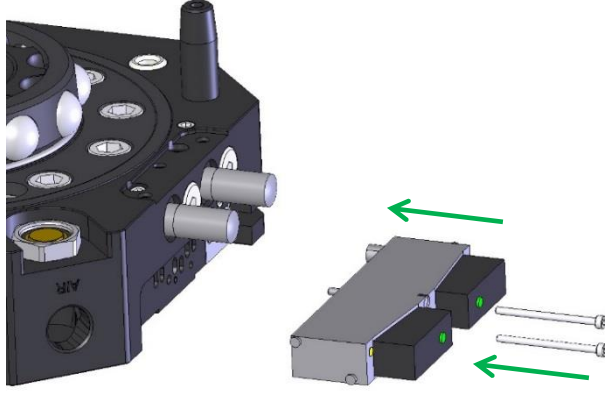
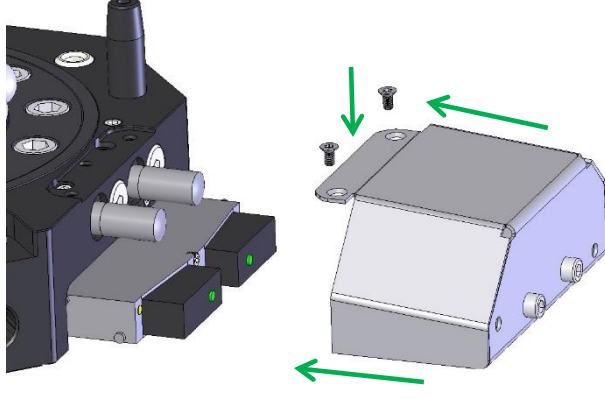
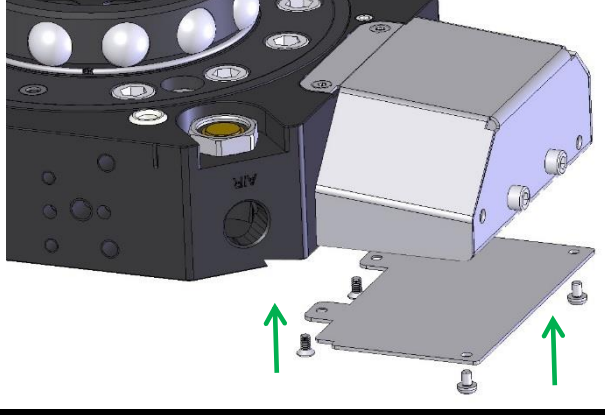
5	<p>Mount silencers</p> 	<p>Insert and mount the two silencers.</p>
6	<p>Mount valve</p> 	<p>Insert and mount the valve with two M3x45 screws.</p>
5	<p>Mount valve cover</p> 	<p>Insert and mount the valve cover with two M4x8 screws.</p>
6	<p>Mount rear valve cover</p> 	<p>Insert and mount the rear valve cover with two M4x6 and two M4x8 screws.</p>

2.7 Mounting of TC ground socket, P7239

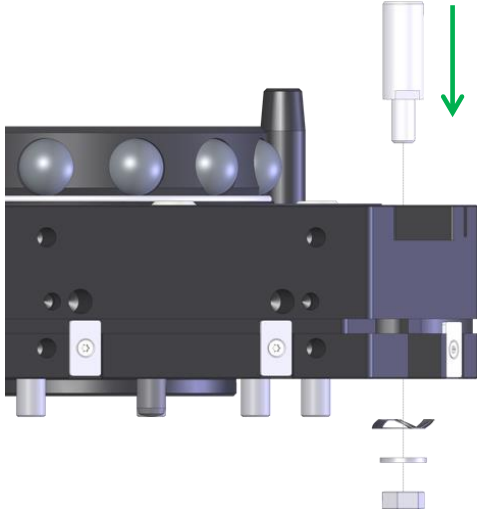
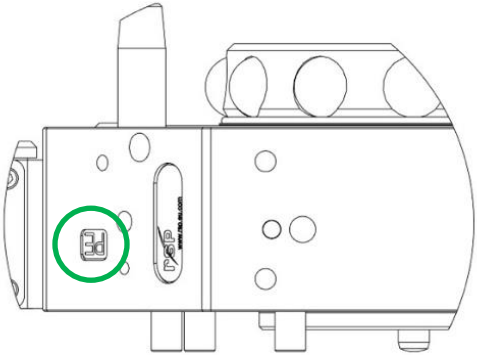
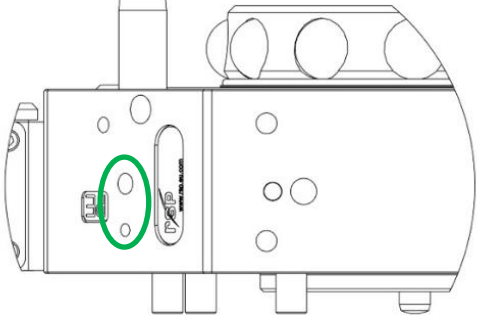

	Action	Note
1	<p>Mount TC ground socket</p> 	<p>Mount the ground socket in the tool changer with enclosed screw and washers.</p> <p>NOTE! Apply a small amount contact grease before mounting.</p>
2	<p>Mount PE label</p> 	<p>Mount the enclosed PE label in the dedicated area close to the RSP label.</p>
3	<p>Mount PE cabling</p> 	<p>Mount the robots earth cable with either an M8 or an M5 screw.</p> <p>NOTE! The dedicated screw holes are situated close to the PE marking.</p>



2.8 Mounting of TA ground socket, P7147

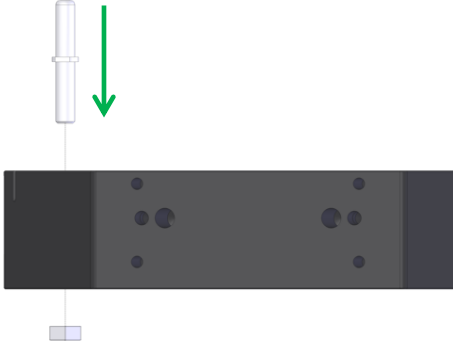
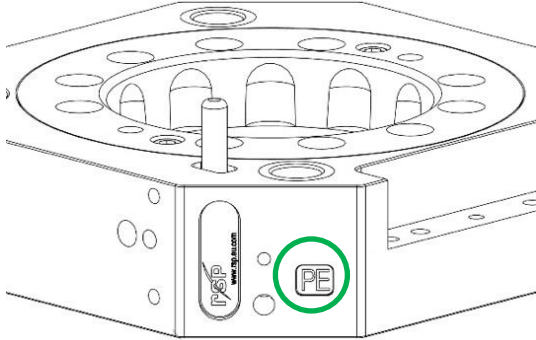
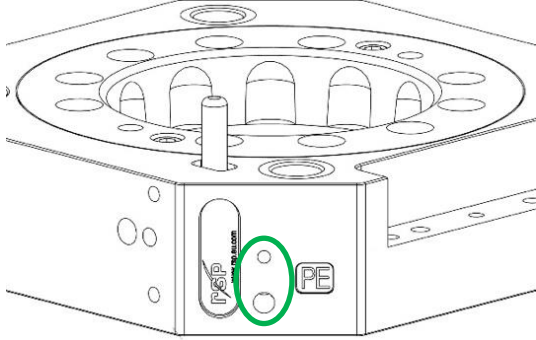

	Action	Note
1	<p>Mount TA ground socket</p> 	<p>Mount the ground socket in the tool changer with enclosed screw.</p> <p>NOTE! Apply a small amount contact grease before mounting.</p> <p>NOTE! The dedicated hole can be found close to the RSP label.</p>
2	<p>Mount PE label</p> 	<p>Mount the enclosed PE label in the dedicated area close to the RSP label.</p>
3	<p>Mount PE cabling</p> 	<p>Mount the tools earth cable with either an M8 or an M5 screw.</p> <p>NOTE! The dedicated screw holes are situated close to the PE marking.</p>



3 TC OPERATION AND INTERFACE

3.1 Software function with RSP integrated safety module

When the RSP integrated safety module is used the procedures and software logic described in the product manual *M8353-1 Integrated safety module* shall be adhered to by the system integrator installing the tool changer.

3.2 Software function without RSP integrated safety module

When RSP integrated safety module is *not used* the risk assessment for this tool changer (locking control function and monitoring) requires that the, generalised, software logic described below is adhered to by the system integrator installing the tool changer.

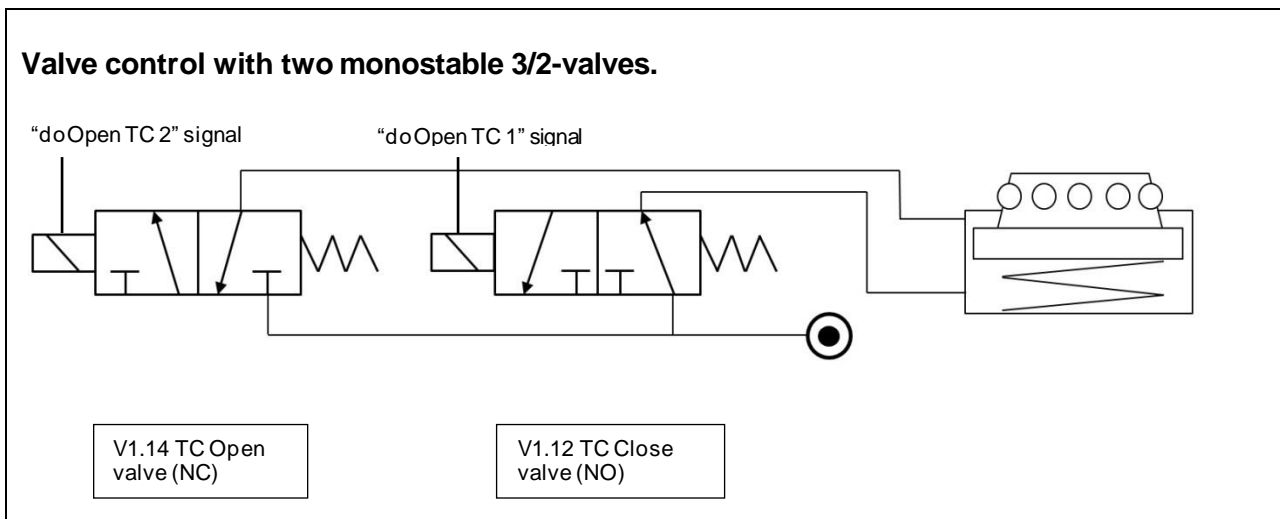

- The right valve, called TC Close, will in passive position allow the air pressure to move the piston in the direction locking the tool. In active position the air will be allowed to be evacuated from the cylinder without impacting the piston.
- The left valve, called TC Open, will in active position let the air pressure move the piston in the direction unlocking the tool. In passive position the air will be evacuated from this side of the cylinder, allowing the tool to be locked.
- As a consequence, both valves must be activated to open the tool changer.
- The "doOpen TC 2" signal shall be interlocked with both a tool attachment (TA) present jumper and a tool stand switch indicating the following safe conditions for opening the tool changer:
 - * When there is no tool attachment mounted, the tool changer can be opened.
 - * When there is a tool attachment mounted, it is only possible to open the tool changer when it is positioned in the tool stand.

Piston status monitoring sensors

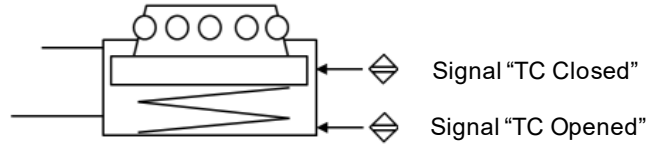

There are two sensors built in into the main body supervising the location of the piston.

- Signal "TC Opened" is high when the piston is in open position.
- Signal "TC Closed" is high when the piston is in locked position.

Signal logic for picking up a tool

- Open the tool changer by setting signals "doOpen TC 1" and "doOpen TC 2" to high.
- When signal "TC Opened" becomes high the tool changer has been opened and is allowed to move to the tool attachment.
- When the tool changer is in position for picking up the tool attachment, the tool changer should be closed (set signals "doOpen TC 1" and "doOpen TC 2" low).
- When signal "TC Closed" is high, the tool changer has been closed and can start to move.
- When the closed tool changer has been lifted 10mm, the signal from the switch or sensor mounted at the tool stand should be checked to confirm that the tool remains in the tool changer.

Set "doOpen TC 1" and "doOpen TC 2" to high

Is "TC Opened" high and "TC Closed" low?

Move robot to tool stand

Is robot in position in tool stand?

Reset "doOpen TC 1" and "doOpen TC 2"

Is "TC Closed" high and "TC Opened" low?

Move robot up 10 mm

Is tool stand switch signals correct?

Continue work cycle

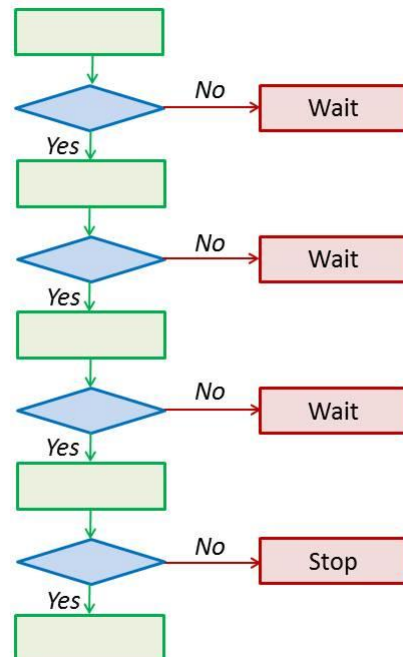

Signal logic for leaving a tool in the tool stand

- Opening of tool changer should only be possible when tool is positioned in tool stand. A switch or sensor mounted at the tool stand should give a signal that allows the tool changer to open.
- Set signals “doOpen TC 1” and “doOpen TC 2” high, when the tool attachment is positioned in the tool stand.
- When signal “TC Opened” is high, the tool changer is opened and can start to move.
- When the opened tool changer has been lifted 10mm, the signal from the switch or sensor mounted at the tool stand should be checked to confirm that the tool remains in the tool stand.

Move the robot to the tool stand position

Is robot in position in tool stand?

Is “tool in stand” signal high?

Set “doOpen TC 1” and “doOpen TC 2” to high

Is “TC Opened” high and “TC Closed” low?

Move robot up 10 mm

Is tool stand switch signals correct?

Continue work cycle

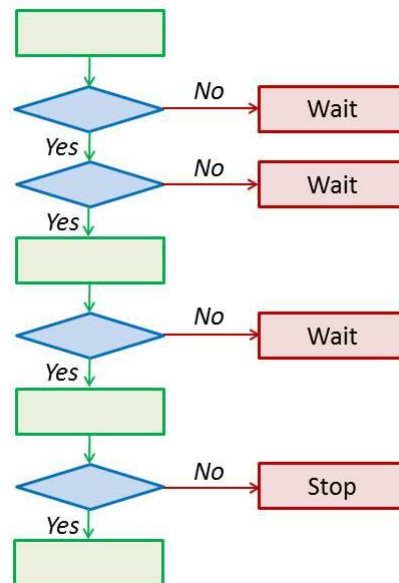

Functional test

For controlling that the tool change valves and the integrated locking spring are functioning following tests should be made regularly:

- With the tool changer in opened position:
Set “doOpen TC 2” to low and let “doOpen TC 1” remain high.
The signal “TC Closed” will become high.
- With the tool changer in opened position:
Let “doOpen TC 2” remain high and set “doOpen TC 1” to low.
The signal “TC Closed” will become high.

Breaking conditions

- If signal “TC Closed” disappears when tool attachment is in tool changer, the robot should be stopped.
- If signal “TC Opened” disappears, when tool changer is going to pick up the tool attachment, the robot should be stopped.
- If signal “TC Opened” is high at the same time as “TC Closed” is high, the robot should be stopped.

3.3 Sparking



WARNING! Electrical signals and power must be switched off and disconnected when docking the tool attachment. This is to prevent sparking between signal pins and tool attachment.

3.4 Programming

The following will ensure a correct docking position.

	Action
1	Attach a spare tool attachment to the tool changer.
2	Position the spare tool attachment above the tool attachment that is mounted at the tool.
3	The correct position is found when the tool attachments are parallel, centered and the engraved arrows are on the same line.
4	Save the position. The robot can move to this position with high speed.
5	Dismount the spare tool attachment.
6	Go back to the saved position and move the tool changer (in axis 6 direction) the remaining distance to the tool attachment (mounted at the tool).
7	Save the position. The robot should move the final distance to this position with low speed.

3.5 Tool Stand



NOTE!

To guarantee reliability and a long service-life for the tool changer, the tool stand must be stable, both in terms of its design and attachment.



NOTE!

The tool stand must not be spring-loaded!

3.6 Tool Identification

Jumpers on signals at the tool attachment can be used to give information about which tool attachment that is docked in the tool changer.

4 MAINTENANCE AND SERVICE

The tool changer and tool attachment must be maintained regularly to ensure proper function. The specified intervals are approximate and valid under normal conditions, corresponding to 2 tool changes per minute during 2 work shifts per working day, i.e. 42.000 changes per month. Under extreme conditions, such as dirty environments or extreme robot movements, the intervals should be shortened. Consider the table as a guide and update as your production experience of each system increases.



WARNING! Risk of getting squeezed between piston and ball holder when the piston is taking closed position.



NOTE! Only perform work on grippers or tools attached to the tool changer if the air pressure is safely switched off.



NOTE! Tool changers must only be dismantled and repaired by Robot System Products during the warranty period. Otherwise the warranty will not be valid.

4.1 Maintenance scheme

4.1.1 Every second week

The following maintenance activities should be carried out every second week.

Activity	Equipment		Description
Inspection	Tool changer	General	Visual inspection (section 4.2.1).
		Locking balls	Check locking balls (section 4.2.1).
	Tool attachment	General	Visual inspection (section 4.2.2).
Cleaning	Tool attachment	Signal contacts	Clean contact surfaces (section 4.2.2).

4.1.2 Every three-months or every 125,000 tool changes

The following maintenance activities should be carried out every three-months or after every 125,000 tool changes, whichever comes first.

Activity	Equipment		Description
Cleaning and lubrication	Tool changer	Weld power sockets	Clean area around sockets (section 4.2.3).
		Water/air couplings	Clean couplings and add lubrication (section 4.2.3).
		Air sealings	Clean sealings (section 4.2.3).
	Tool attachment	Water/air couplings	Clean couplings and add lubrication (section 4.2.4).
		Air sealings	Clean sealings (section 4.2.4).

4.1.3 Every six-months or after every 250,000 tool changes

The following maintenance activities should be carried out every six-months or after every 250,000 tool changes, whichever comes first.

Activity	Equipment	Description	
Cleaning and lubrication	Tool changer	Locking balls	Clean locking balls and add new lubrication, (see section 4.2.5).
		Guide pins	Clean guide pins and add new lubrication (see section 4.2.5).
		Spring-loaded pins	Clean spring-loaded signal pins (section 4.2.5).
		Servo power sockets	Clean around the sockets and add new lubrication (see section 4.2.5).
		Weld power sockets	Add new lubrication in weld power sockets (see section 4.2.5).
	Tool attachment	Locking cavities	Wipe cavities of locking balls clean (section 4.2.6).
		Guide bushings	Clean guide pin bushings and add new lubrication (see section 4.2.6).
		Servo power pins	Clean servo power pins and add new lubrication (section 4.2.6).
Weld power pins		Clean weld power pins (section 4.2.6).	

4.1.4 To replace when damaged or worn-out





Equipment	Description	
Tool changer	Dampers	See section 6.3.1
	Guide pins	See section 6.3.2
	Spring-loaded signal pins	See section 6.3.4
	Water/air couplings	See section 6.3.5
	Weld power sockets	See section 6.3.6
	Air sealings	See section 6.3.8
	Electric modules	See section 6.3.10
	Water/air modules	See section 6.3.11
Tool attachment	Guide bushings	See section 6.3.3
	Water/air couplings	See section 6.3.5
	Weld power pins	See section 6.3.7
	Air sealings	See section 6.3.8
	O-rings	See section 6.3.9
	Electric modules	See section 6.3.10
	Water/air modules	See section 6.3.11



4.2 Specification of maintenance activities

4.2.1 Visual inspection of tool changer (every 2nd week)

The following maintenance activities should be carried out on the TC every 2nd week.



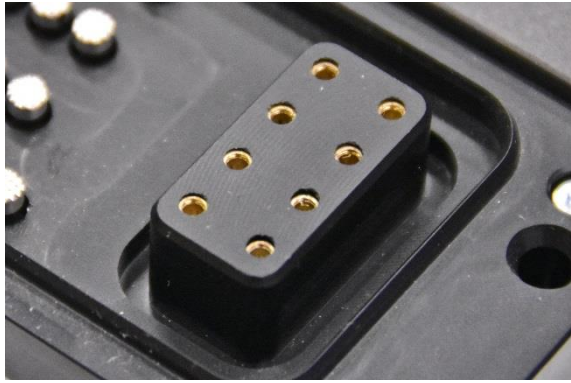
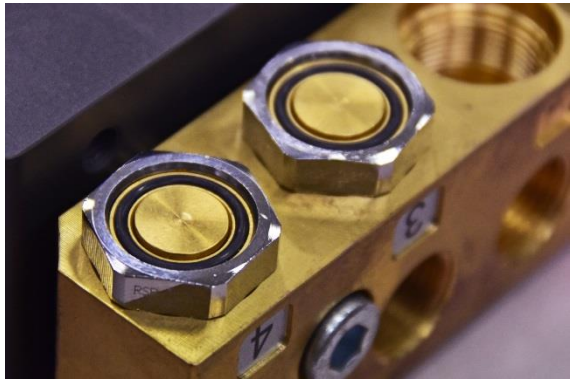

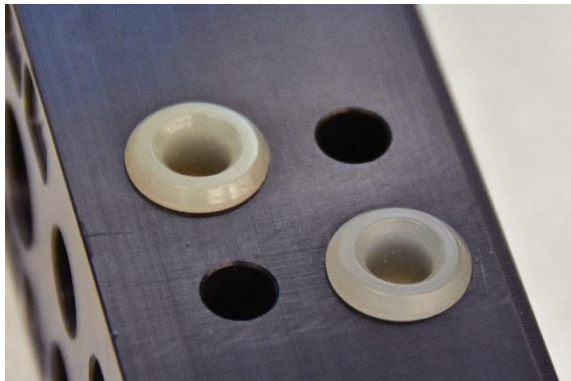



Action	Note
<p>Check locking balls</p> 	<p>Check each ball to make sure it moves freely. For cleaning and lubrication of balls see section 4.2.5.</p> <p>NOTE! If balls get stuck there is a risk that the tool attachment jams.</p>
<p>Check dampers</p> 	<p>Check the dampers for damages. For making replacements see section 6.3.1.</p>
<p>Check guide pins</p> 	<p>Check that the guide pins are greased. For cleaning and lubrication see section 4.2.5.</p> <p>Check that the guide pins are not worn-out or damaged. For making replacements see section 6.3.2.</p>
<p>Check signal pins</p> 	<p>Check that the spring-loaded signal pins are clean. For cleaning see section 4.2.5.</p> <p>Check that the spring-loaded signal pins are not worn-out or damaged. For making replacements see section 6.3.4.</p>

<p>Check servo power socket</p> 	<p>Check that the area around the servo power sockets is clean. For cleaning and lubrication see section 4.2.5.</p> <p>Check that the servo power sockets are not worn-out or damaged. If worn-out or damaged replace module, see section 6.3.10.</p>
<p>Check water/air couplings</p> 	<p>Check that the couplings are clean. For cleaning and lubrication see section 4.2.3.</p> <p>Check that the couplings, or the module, are not worn-out, leaking or damaged. For replacing couplings see section 6.3.5. For replacing the module, see section 6.3.11.</p>
<p>Check weld power sockets</p> 	<p>Check that the area around the weld power sockets is clean. For cleaning and lubrication see sections 4.2.3 and 4.2.5.</p> <p>Check that the weld power sockets, or the module, are not worn-out or damaged. For replacing the weld power sockets, see section 6.3.6. For replacing the module, see section, 6.3.10.</p>
<p>Check air sealings</p> 	<p>Check that the air sealings are clean. For cleaning see section 4.2.3.</p> <p>Check that the air sealings, or the module, are not damaged. For replacing air sealings see section 6.3.8. For replacing the module see section 6.3.11.</p>
<p>Check cables</p>	<p>Check cables for damages and squeezing, replace if damaged.</p>
<p>Check tool changer in general</p>	<p>Check the tool changer for damages. For replacement see section 6.1.</p>

4.2.2 Visual inspection and cleaning of tool attachment (every 2nd week)

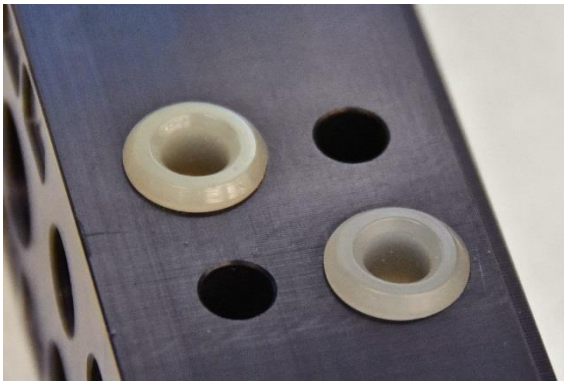
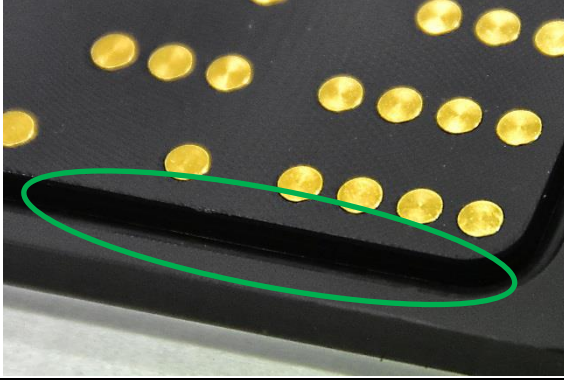

The following maintenance activities should be carried out on the TA every 2nd week.

Action	Note
<p>Check guide bushings</p> 	<p>Check that the guide bushings are greased. For cleaning and lubrication see section 4.2.6.</p> <p>Check that the guide bushings are not worn-out or damaged. For making replacements see section 6.3.3.</p>
<p>Check servo power pins</p> 	<p>Check that the servo power pins are clean. For cleaning and lubrication see section 4.2.6.</p> <p>Check that the servo power pins are not worn-out or damaged. If worn-out or damaged replace module, see section 6.3.10.</p>
<p>Check water/air couplings</p> 	<p>Check that the couplings are clean. For cleaning and lubrication see section 4.2.4.</p> <p>Check that the couplings, or the module, are not worn-out, leaking or damaged. For replacing couplings see section 6.3.5. For replacing the module, see section 6.3.11.</p>
<p>Check weld power pins</p> 	<p>Check that the weld power pins are clean. For cleaning and lubrication see section 4.2.6.</p> <p>Check that the weld power pins are not worn-out or damaged. For replacing weld pins, see section 6.3.7. For replacing the module, see section, 6.3.10.</p>

<p>Check air sealings</p> 	<p>Check that the air sealings are clean. For cleaning see section 4.2.4.</p> <p>Check that the air sealings, or the module, are not damaged. For replacing air sealings see section 6.3.8. For replacing the module see section 6.3.11.</p>
<p>Check O-rings</p> 	<p>Check that O-rings on signal and power modules are not worn-out or damaged. For making replacements see section 6.3.9.</p>
<p>Clean surface of signal contact</p> 	<p>Wipe the contact surface with a lint free cloth.</p>
<p>Check cables</p>	<p>Check cables for damages and squeezing, replace if damaged.</p>
<p>Check tool attachment in general</p>	<p>Check the tool attachment for damages. For replacement see section 6.2.</p>



4.2.3 Cleaning and lubrication of TC (every 3rd month or 125,000 tool changes)

The following maintenance activities should be carried out on the tool changer every 3rd month or after 125,000 tool changes, whichever comes first.

Action	Note
<p>Clean around weld power sockets</p> 	<p>Wipe the outer parts of the weld power sockets and the surrounding surface with a lint free cloth.</p>
<p>Clean water/air couplings</p> 	<p>Wipe the couplings with a lint free cloth. Apply a small amount of grease (Magnalube-G) on the contact surfaces.</p>
<p>Clean air sealings</p> 	<p>Wipe air sealings clean with a lint free cloth.</p>





4.2.4 Cleaning and lubrication of tool attachment (every 3rd month or 125,000 tool changes)

The following maintenance activities should be carried out on the tool attachment every 3rd month or after 125,000 tool changes, whichever comes first.

Action	Note
<p data-bbox="362 376 694 409">Clean water/air couplings</p> 	<p data-bbox="986 376 1401 504">Clean the couplings with a lint free cloth. Apply a small amount of grease (Magnalube-G) on the contact surfaces.</p>
<p data-bbox="362 797 593 831">Clean air sealings</p> 	<p data-bbox="978 797 1377 860">Wipe air sealings clean with a lint free cloth.</p>

4.2.5 Cleaning and lubrication of TC (every 6th month or 250,000 tool changes)

The following maintenance activities should be carried out on the tool changer every 6th month or after 250,000 tool changes, whichever comes first.

Action	Note
<p>Clean locking balls</p> 	<p>Check the locking balls and wipe them clean with a lint free cloth.</p>
<p>Lubricate locking balls</p> 	<p>Apply a small amount of grease (Molykote BR2Plus) on the locking balls.</p> <p>NOTE! It is important that this is done or else there is a risk that the tool attachment jams.</p>
<p>Clean guide pins</p> 	<p>Wipe the guide pins with a lint free cloth.</p>
<p>Lubricate guide pins</p> 	<p>Apply a small amount of grease (Molykote BR2Plus) on the guide pins.</p>



Clean signal pins



Clean the contact surfaces of the spring-loaded signal pins with a nylon brush.

NOTE!

Signal pins shall be cleaned whenever blackened.

Lubricate servo power socket



Wipe the area around the servo power sockets clean and apply a small amount of grease (Electrolube SGB) in the sockets.

NOTE! It is important that this is done to preserve durability.

Lubricate weld power socket





Apply a small amount of grease (Electrolube SGB) inside the weld power sockets.

NOTE! It is important that this is done to preserve durability.

4.2.6 Cleaning and lubrication of tool attachment (every 6th month or 250,000 tool changes)

The following maintenance activities should be carried out on the tool attachment every 6th month or after 250,000 tool changes, whichever comes first.



Action	Note
<p>Clean locking cavities</p> 	<p>Clean the cavities of the locking balls.</p> <p>NOTE! It is important that this is done or else there is a risk that the tool attachment jams.</p>
<p>Clean and lubricate guide bushings</p> 	<p>Wipe clean and apply small amount of grease (Molykote BR2Plus) inside the guide pin bushings.</p>
<p>Clean servo power pins</p> 	<p>Wipe clean the servo power pins with a lint free cloth!</p>

Lubricate servo power pins



Apply a small amount of grease (Electrolube SGB) on the servo power pins.

Clean weld power pins



Wipe clean the weld power pins with a lint free cloth!

5 MANUAL UNLOCKING OF TOOL CHANGER

5.1 Manual unlocking

In case of failure of the control system controlling the integrated valve, the tool attachment can be released through manual operation of the twin switches on the integrated valve.

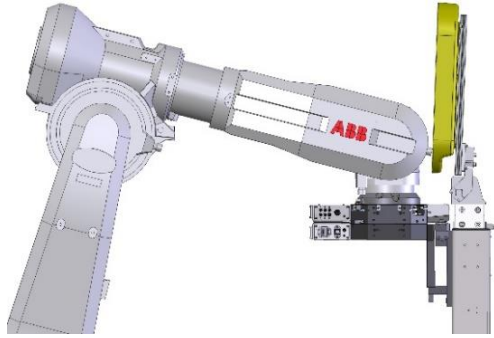
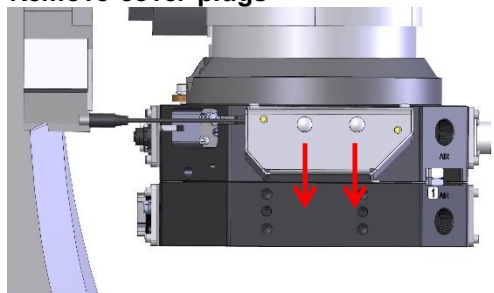
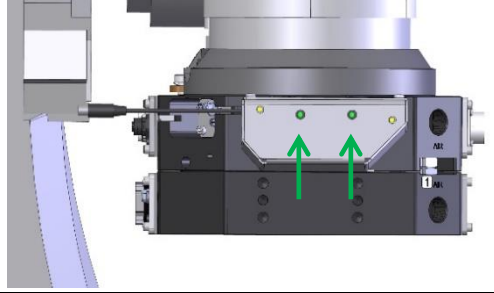
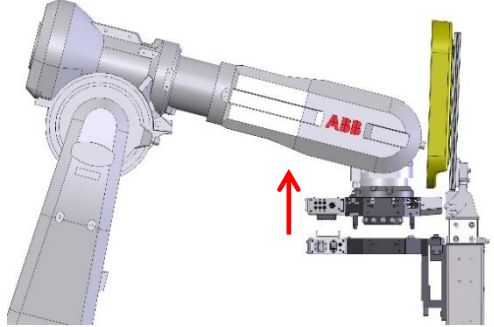

	Action	Note
1	Safety	Read the safety section (1.2).
2	Position tool 	Place tool attachment and tool in position for undocking. NOTE! The tool attachment and tool must be fully supported by a tool stand or table.
3	Pneumatic air on	Air hoses shall be safely connected and the pressure in the pneumatic system shall be on (6–10 bar).
4	Remove cover plugs 	Remove the two plugs covering the manual control switches.
5	Release tool attachment 	Press <i>both</i> manual control switches simultaneously, with thin shaft screwdrivers or similar, at the rear of the integrated valve. WARNING! The tool attachment will be instantly released when both switches are pressed!
6	Remove tool attachment 	Remove tool changer from tool attachment by moving the robot in manual mode. NOTE! Both control switches must be continuously pressed during movement. WARNING! The tool attachment is heavy and may cause personal injury and equipment damage if dropped.



5.2 Forced manual unlocking, P6910

In case the tool attachment is jammed and mechanically stuck to the tool changer, the tool attachment can be released using a forced opening kit and a grease gun. Such forced opening kit, with product number P6910, can be obtained from Robot System Products.





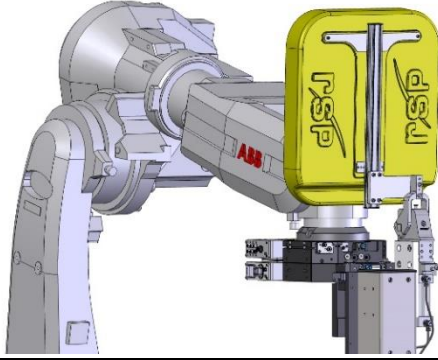
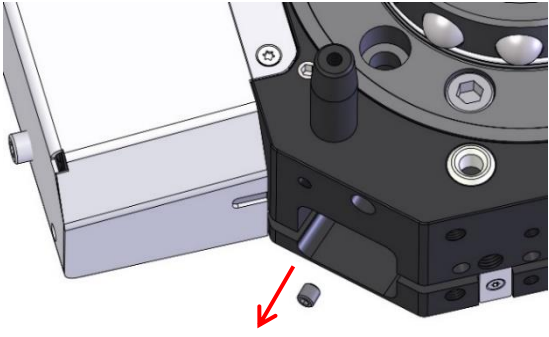
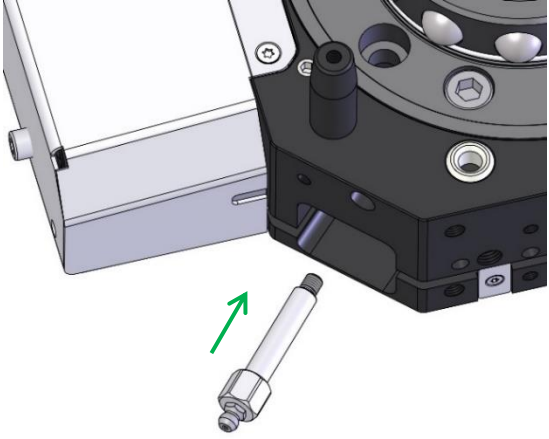

NOTE!

Forced manual unlocking shall only be carried out when tool attachment is stuck to the tool changer and cannot be released through other means.

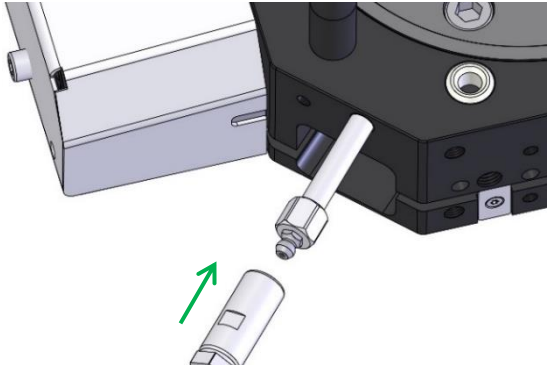
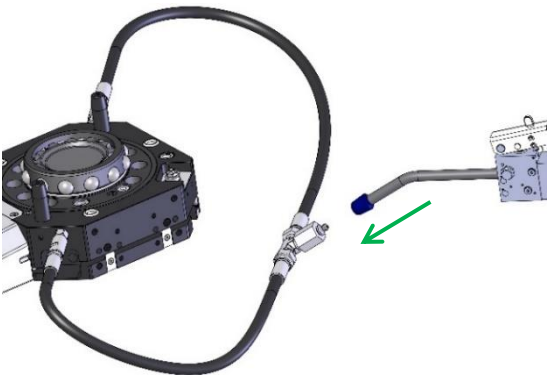
	Action	Note
1	Safety	Read the safety section (1.2).
2	Position robot and tool 	Place robot in position for undocking of tool attachment and tool. NOTE! Make sure the tool attachment and tool are fully supported by a tool stand or table.
3	Pneumatic air off	Switch off the pneumatic air. NOTE! The air pressure must be fully relieved before dismounting.
4	Remove plug 	Unscrew and remove the protection plugs from the two connections for manual unlocking using an Allen key. NOTE! The connections for manual unlocking are positioned diagonally across the tool changer.
6	Connect forced opening kit 	Screw the two coupling extenders to each dedicated position on the tool changer. NOTE! The coupling extenders are included in the forced opening kit (P6910).

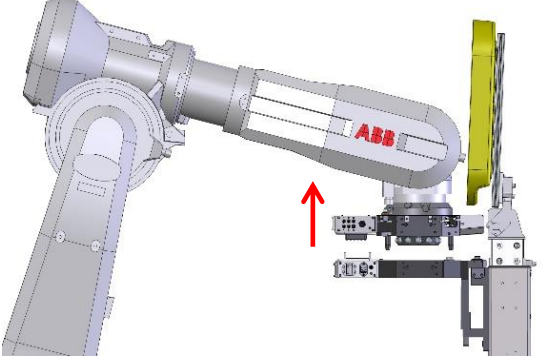

7	<p>Connect forced opening kit</p> 	<p>Connect the hoses of the forced opening kit to the nipples on the coupling extender.</p>
8	<p>Connect grease gun</p> 	<p>Connect a grease gun to the nipple (DIN 71412) on the hose assembly on the forced opening kit.</p>
9	<p>Unlock tool changer</p> 	<p>Unlock tool changer by pressing grease through the forced opening kit with the grease gun.</p> <p>WARNING! The tool attachment is heavy and may cause personal injury and equipment damage if dropped.</p>
10	<p>Remove tool attachment</p> 	<p>Remove tool changer from tool attachment by moving the robot in manual mode.</p> <p>WARNING! The tool attachment is heavy and may cause personal injury and equipment damage if dropped.</p>
11	<p>Analysis and overhaul</p> 	<p>NOTE! After forced unlocking, a failure analysis and a complete overhaul of the tool changer should be performed. It is recommended that these are carried out by qualified RSP personnel.</p>

6 DISMOUNTING AND REPLACEMENT

6.1 Replacement of tool changer



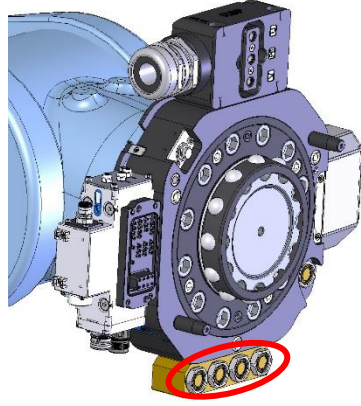
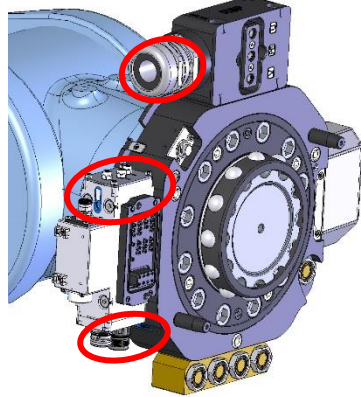

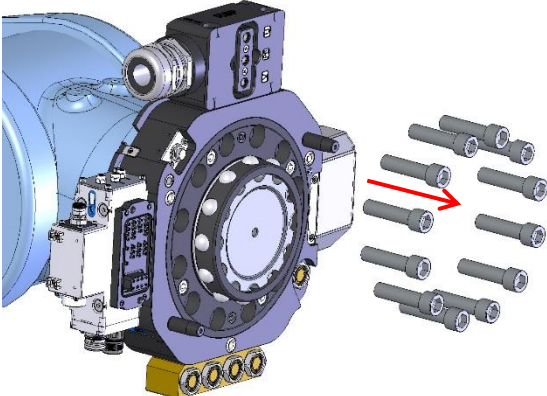
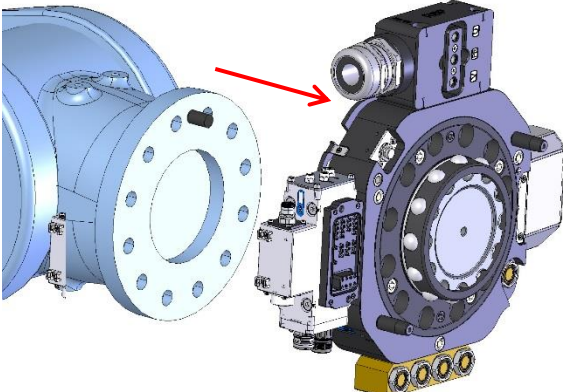
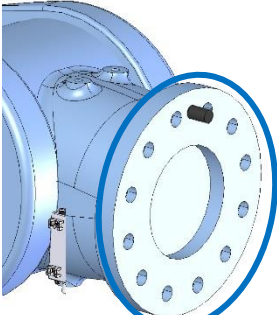

	Action	Note
1	Safety	Read the safety section (1.2).
2	Dismount tool	Leave tool, with tool attachment mounted, in tool stand.
3	Service position	Place the robot in service position. NOTE! The tool change function shall be in locked position.
4	Power off	Switch the power off and lock the circuit breaker. NOTE! Read the safety chapter for the robot.
5	Pneumatic air off	Switch off the pneumatic air. NOTE! The pressure in the pneumatic system must be released before dismounting begins.
6	Dismount hoses 	Dismount the water/air hoses from the tool changer. NOTE! Make sure that no dirt enters the air hoses.
7	Disconnect electric connections 	Disconnect electric power and signals. NOTE! Handle the contacts with care, as they are sensitive to mechanical damage. Make sure that no dirt enters the contacts.



8	Remove screws 	Remove the screws holding the tool changer to the robot flange. WARNING! The tool changer is heavy and may cause personal injury and equipment damage if dropped.
9	Dismount tool changer 	NOTE! Be careful not to damage the signal pins at the tool side of the tool changer. NOTE! A guide pin is mounted between the tool changer and the robot flange.
10	Cleaning 	Clean the robot flange.
11	Mount tool changer	Follow instructions in section 2.1.

6.2 Replacement of tool attachment

	Action	Note
	1 Safety	Read the safety section (1.2).
	2 Undock tool	Place and undock tool attachment, with tool mounted, in a safe and fully supported position for dismantling.
	3 Dismount hoses	<p>Dismount the water/air hoses from the tool attachment.</p> <p>NOTE! Make sure that no dirt enters the water/air hoses.</p>
 	4 Disconnect electric connections	<p>Disconnect electric power and signals.</p> <p>NOTE! Handle contacts with care, as they are sensitive to mechanical damage. Make sure that no dirt enters the contacts.</p> <p>NOTE! Be careful not to damage the servo and weld power pins.</p>
 	5 Remove screws	<p>Remove the screws holding the tool attachment to the tool.</p> <p>NOTE! The tool attachment can be fitted to the gripper/tool in two ways.</p> <p>WARNING! The tool attachment is heavy and may cause personal injury and equipment damage if dropped.</p>

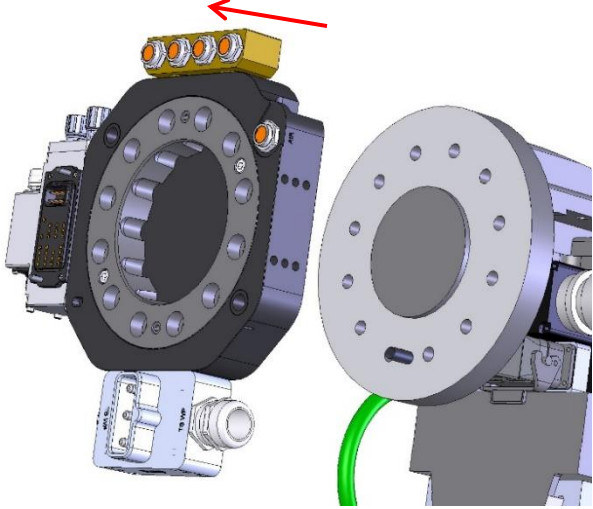

6	Dismount tool attachment 	NOTE! A guide pin is mounted between the tool attachment and the tool.
7	Clean the flange at the tool	
8	Mount tool attachment	Follow instructions in section 2.2.

6.3 Replacement of wear parts

6.3.1 Replacement of dampers on tool changers

Replace dampers when damaged.

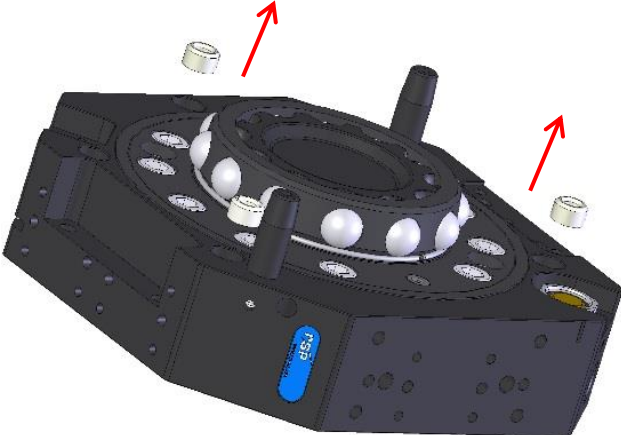
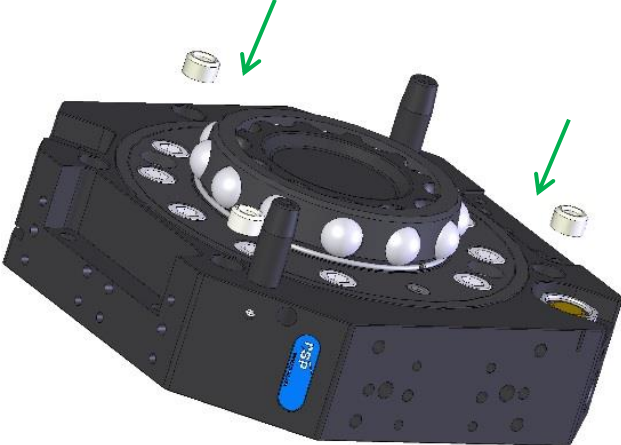

	Action	Note
1	<p>Remove dampers</p> 	<p>Remove dampers with a screw driver.</p> <p>NOTE! There are totally 4 dampers on TC240 and totally 3 on TC480, TC720 and TC960 respectively.</p>
2	<p>Mount new dampers</p> 	<p>Tap in new dampers with a plastic mallet.</p>

6.3.2 Replacement of guide pins on tool changers

Replace guide pins when worn-out or damaged.

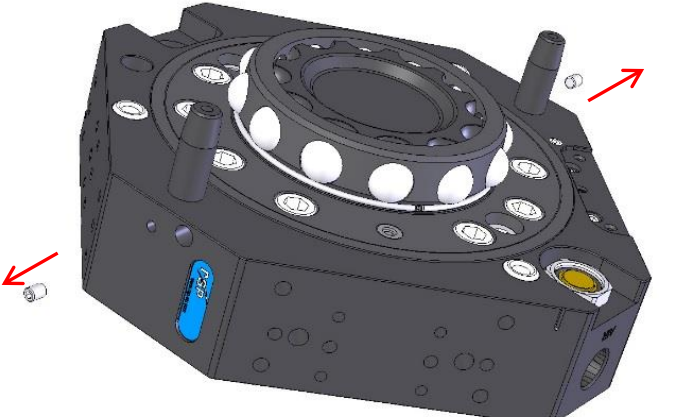
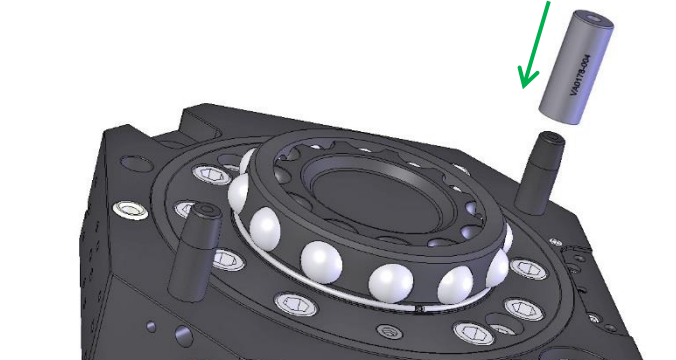
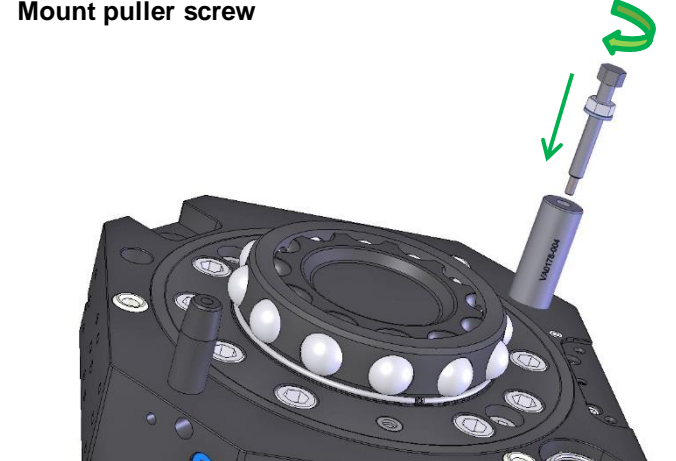
	Action	Note
1	<p>Loosen stop screws</p> 	<p>Loosen the two M6 socket head cap screws securing the guide pins.</p>
2	<p>Mount puller housing</p> 	<p>Enter the puller housing of the Guide pin puller (VA0178.004) over the guide pin.</p>
3	<p>Mount puller screw</p> 	<p>Enter the puller screw through the puller housing and guide pin. Fasten to the tool changer by screwing clockwise with a 16 mm spanner.</p> <p>NOTE! Tightening torque max 10Nm.</p>



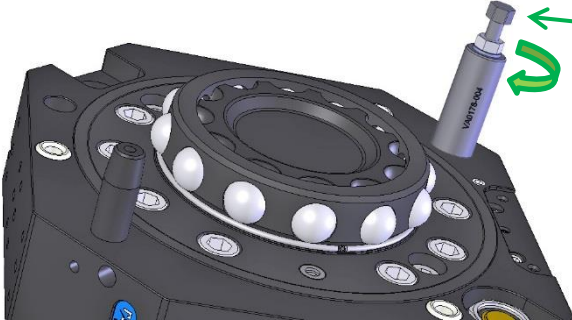
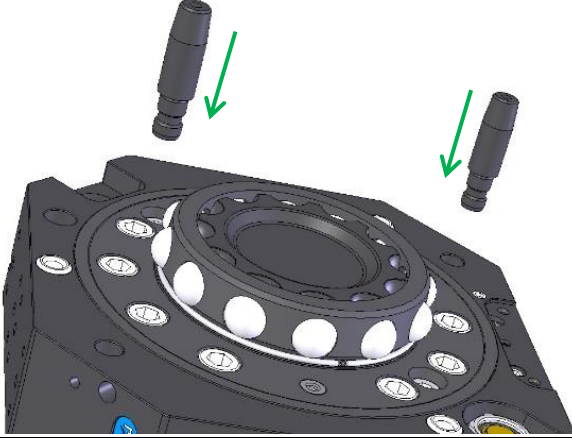
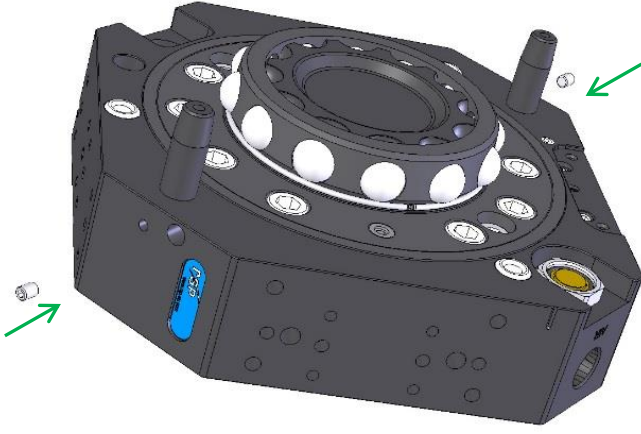

4	Dismount guide pins 	Pull out the guide pin by screwing the M10 nut clockwise with a 16 mm spanner. NOTE! The puller screw shall be kept in position with a 16 mm spanner!
5	Mount new guide pins 	Apply Loctite 638 on the guide pins and in the guide pin holes. Press the new guide pins into the tool changer.
6	Fasten stop screws 	Apply Loctite 638 on the M6 socket head cap screws and fasten them.

6.3.3 Replacement of guide bushings on tool attachments



Replace guide bushings when worn-out or damaged.

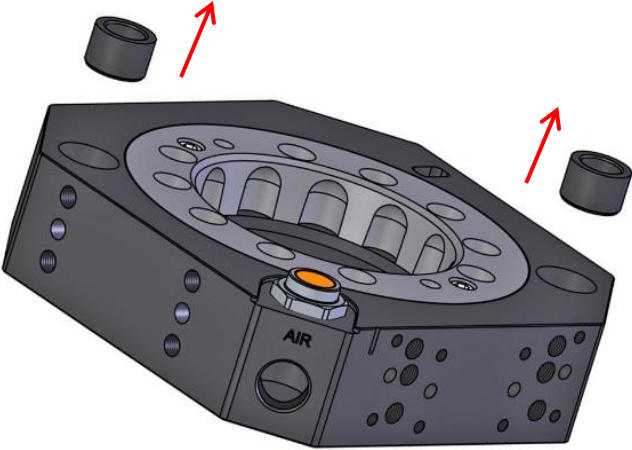
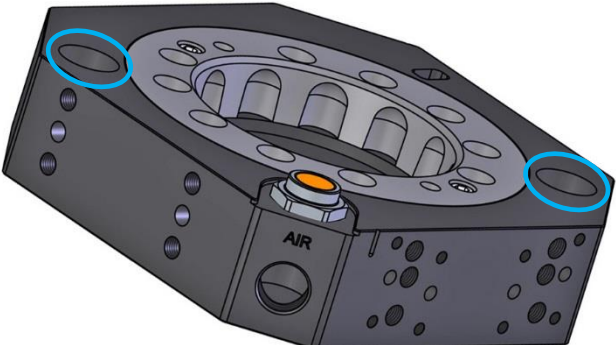
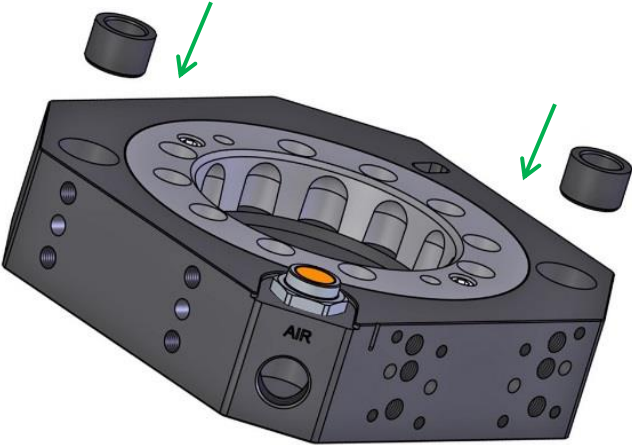

	Action	Note
1	<p>Dismount guide bushings</p> 	<p>Dismount the guide bushings. Use a sliding hammer with bearing puller.</p> <p>NOTE! A special demounting tool, P0230-141, can be ordered from RSP.</p>
2	<p>Clean bushing holes</p> 	<p>Remove all remaining parts of glue and clean with industrial alcohol or similar.</p>
3	<p>Mount new guide bushings</p> 	<p>Apply Loctite 638 on the guide bushings and in the guide bushing holes. Press the new guide bushing into the tool changer.</p>

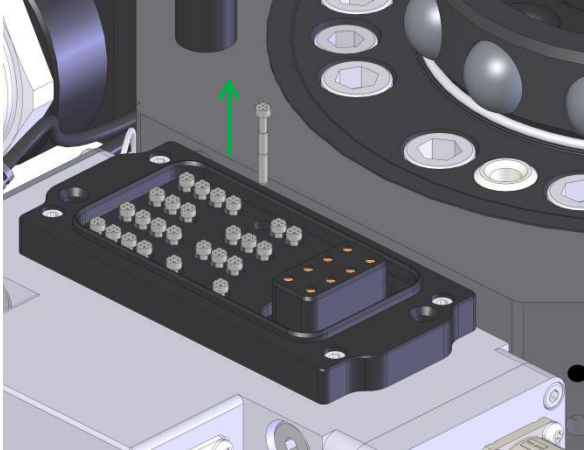
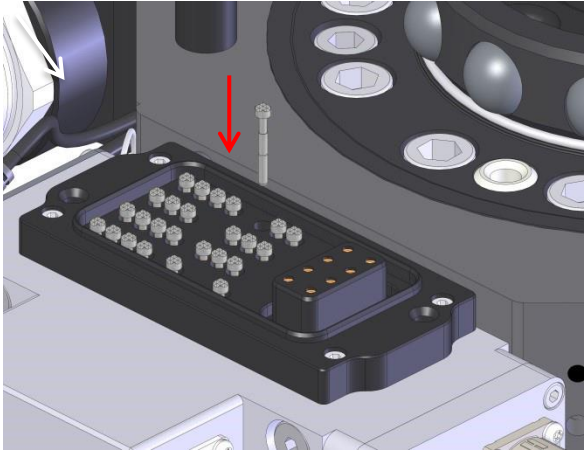

6.3.4 Replacement of spring-loaded signal pins

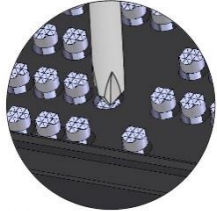
Replace spring-loaded signal pins when worn-out or damaged.

	Action	Note
1	Switch power off	Switch the power off and lock the circuit breaker.
2	Remove signal pins 	Pull out the signal pins with a pair of pliers.
3	Replace signal pins  	Fit the new signal pins by pushing them into the sleeves. NOTE! The signal pins must be individually pressed fully into the sleeves using a small screw driver! 
4	Switch power on	Unlock the circuit breaker and switch the power on.

6.3.5 Replacement of water/air couplings

Replace water/air couplings when worn-out, leaking or damaged.

	Action	Note
1	Water and air off	Switch off and evacuate water and pneumatic air.
2	Clean water/air couplings 	Clean the area around the water/air couplings.
3	Remove water/air couplings 	Remove the water/air couplings with a 27mm socket wrench. NOTE! Don't mix up female/male couplings.
4	Clean around the water/air couplings 	Wipe clean the area around the hole of the water/air couplings.



5	Lubricate new water/air couplings 	Apply a small amount of grease (Magnalube-G) on the O-ring and threads.
6	Mount new water/air couplings 	Mount the new water/air coupling and apply a small amount of grease (Magnalube-G) on the contact surface. NOTE! Tightening torque 20Nm.
7	Water and air on	Switch on water and pneumatic air.









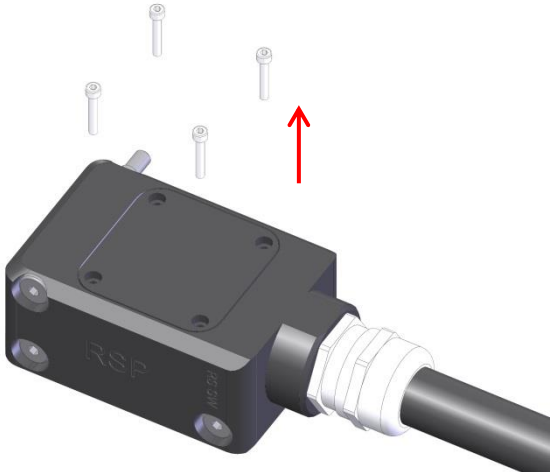
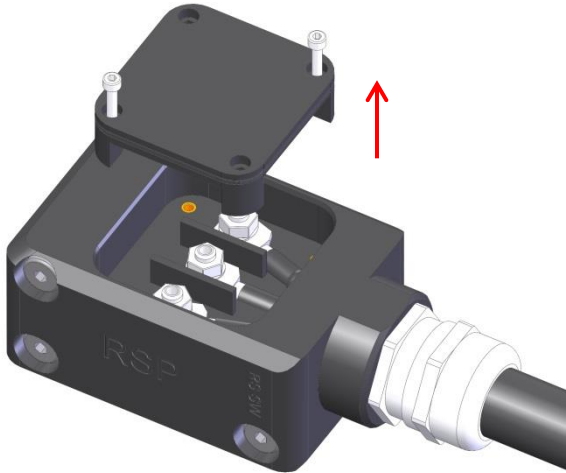
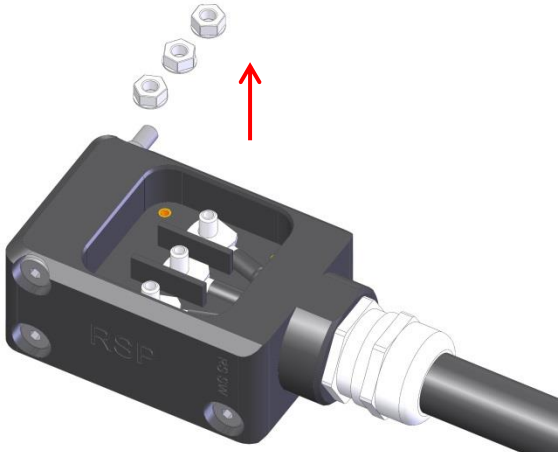

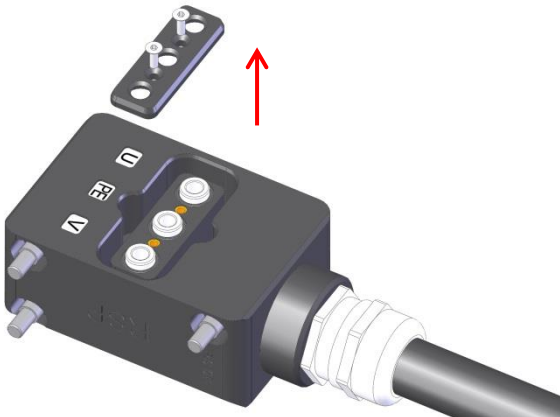
6.3.6 Replacement of weld power sockets

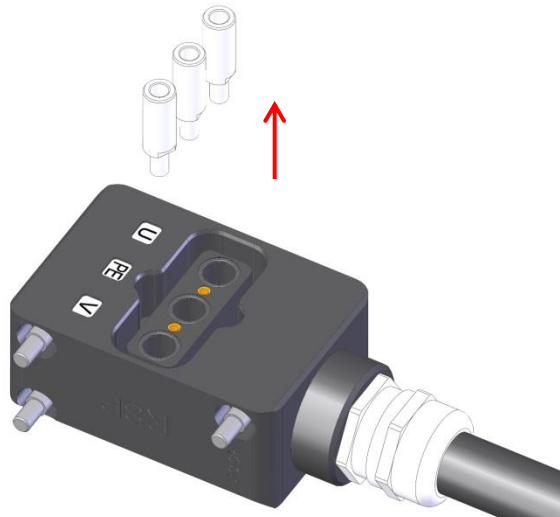
Replace weld power sockets when worn-out or damaged.

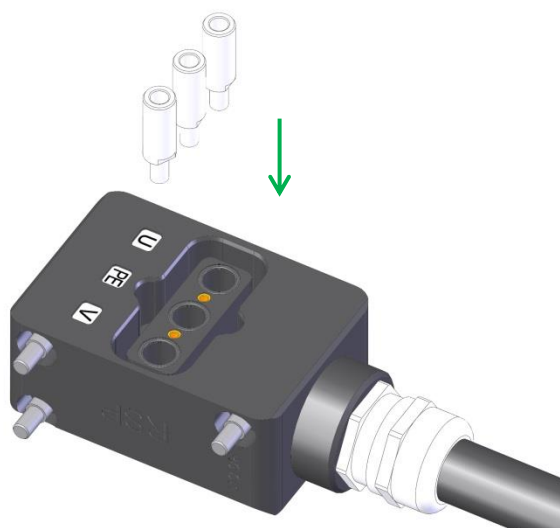

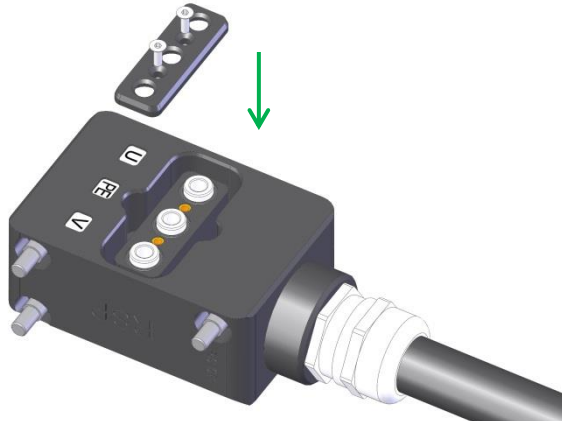
	Action	Note
1	Switch power off	Switch the power off and lock circuit breaker. NOTE! Both weld and robot power must be switched off.
2	Remove screws 	Remove the four M4 screws which are holding the cover on the rear side of the weld power connector.
3	Remove cover 	Insert two M5 screws to remove the cover.
4	Remove nuts and cable lugs 	Remove the three M8 nuts, the washers and the cable lugs.

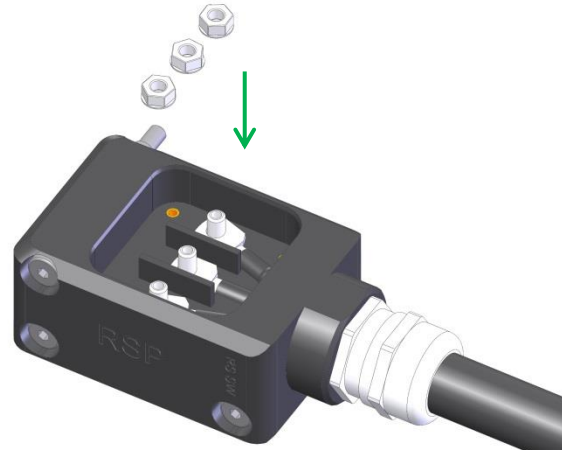
5	<p>Remove cover</p> 	<p>Remove the two M4 screws and the cover on the front side.</p>
6	 <p>Pull out weld power sockets</p> 	<p>Pull out the three weld power sockets.</p> <p>NOTE! Be careful not to drop or damage the O-rings around the sockets.</p>
7	  <p>Replace weld power sockets</p> 	<p>Push in the new weld power sockets.</p> <p>NOTE! The sockets have to be rotated to the correct position in order to be fully pushed into the weld contact.</p> <p>NOTE! Be careful not to damage the O-rings.</p>

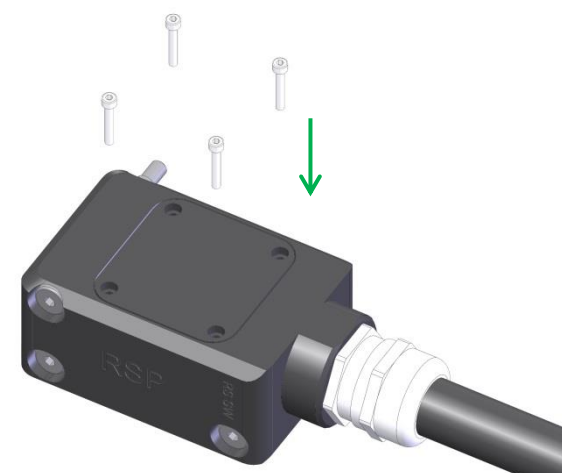
8	<p>Mount cover</p> 	<p>Mount the cover on the front side with two M4 screws.</p>
9	 <p>Mount cable lugs and nuts</p> 	<p>Mount the cable lugs at the weld cable with washers and M8 nuts, on the rear side of the weld power connector.</p> <p>NOTE! Maximum torque for the M8 nuts are 6 Nm.</p>
10	 <p>Mount rear cover</p> 	<p>Mount the rear cover with four M4 screws. Apply a small amount of grease (Electrolube SGB) inside the weld power socket.</p> <p>NOTE! Be careful not to damage the O-ring.</p>
11	<p>Switch power on</p>	<p>Unlock circuit breaker and switch the power on.</p>

6.3.7 Replacement of weld power pins

Replace weld power pins when worn-out or damaged.

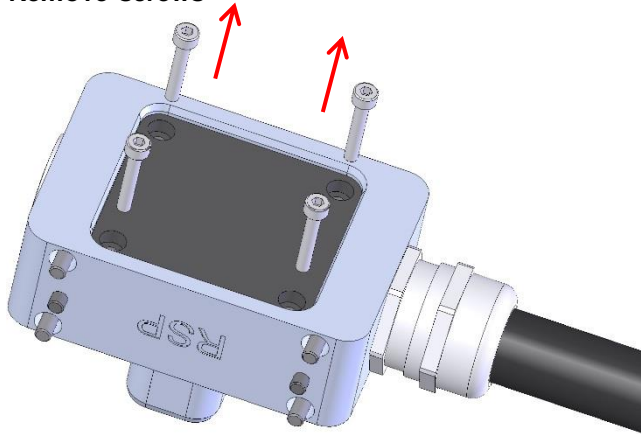
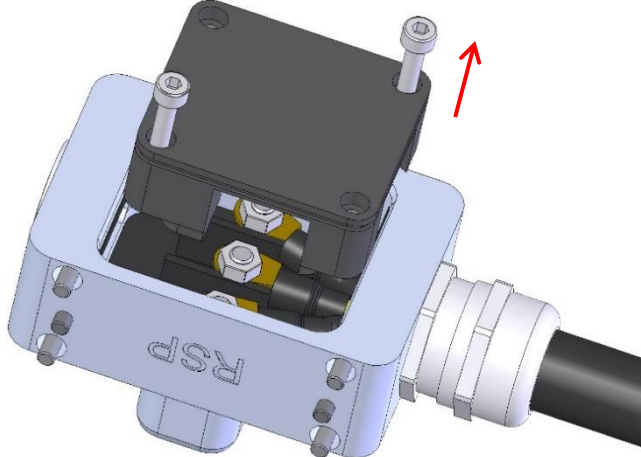
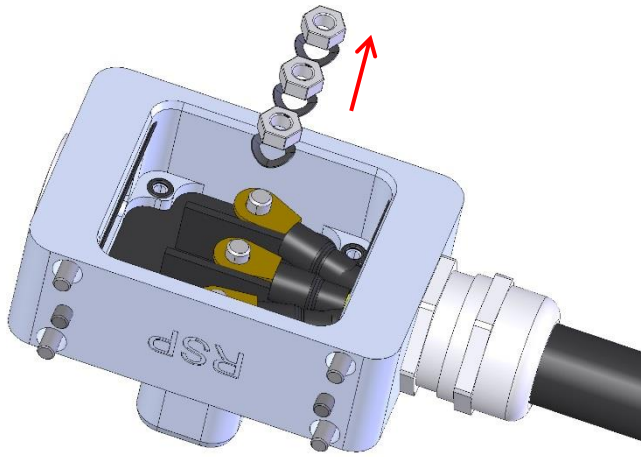
	Action	Note
1	Remove screws 	Unscrew and remove the four M5 screws holding the cover on the rear side of the weld power connector.
2	Remove cover 	Insert two M6 screws to remove the cover.
3	Remove nuts 	Remove the three M8 nuts and the washers.

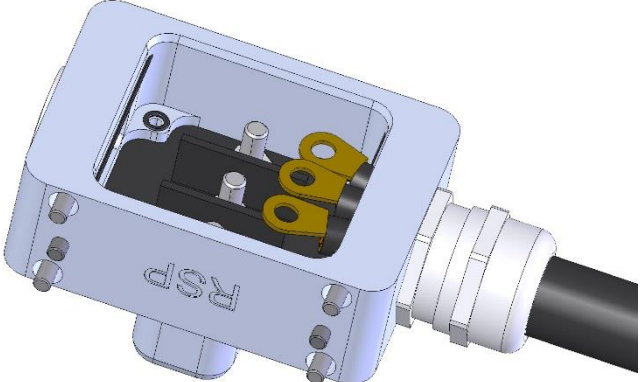
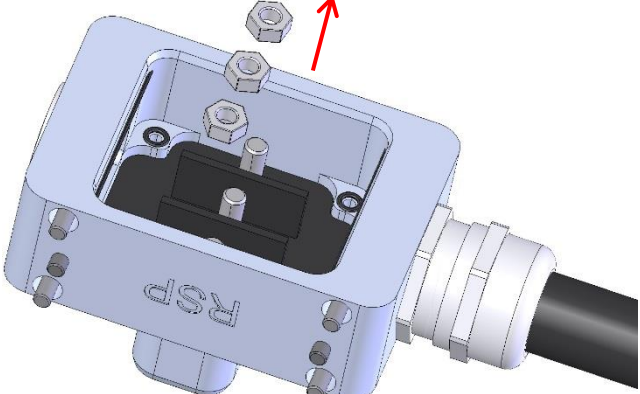
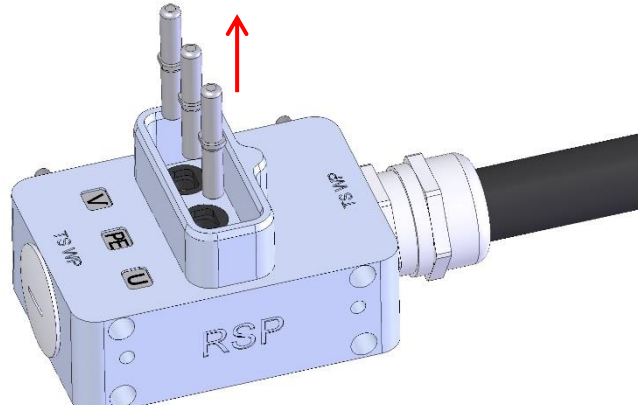
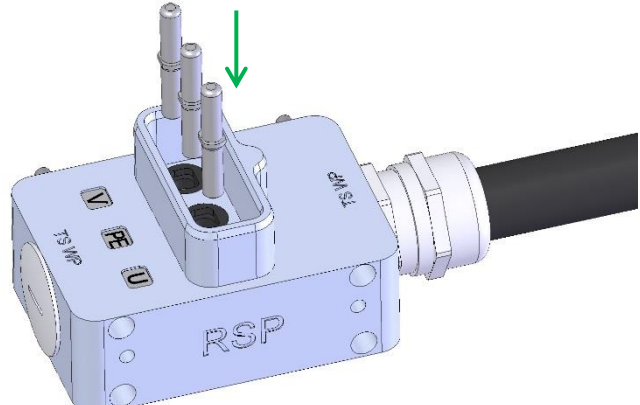
<p>4</p>	<p>Remove nuts and weld cable</p> 	<p>Remove the cable lugs from the backside of the weld power pins.</p>
<p>5</p>	<p>Release weld power pins</p> 	<p>Unscrew and remove the three M8 nuts holding the weld power pins</p>
<p>6</p>	<p>Pull out weld power pins</p> 	<p>Pull out the three weld power pins from the opposite side of the interface.</p>
<p>7</p>	<p>Replace weld power pins</p> 	<p>Push in new weld power pins.</p> <p>NOTE! The pins have to be rotated to the correct position in order to be fully pushed into the weld power connector.</p>





8

Fasten weld power pins

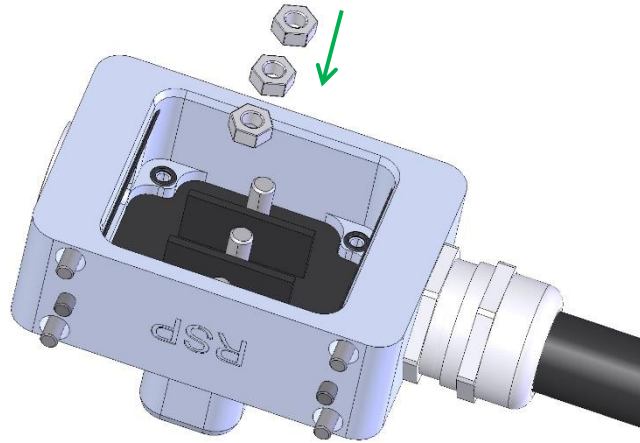

Fasten the replaced weld power pins with three M8 nuts from the rear side of the weld contact.

NOTE! Maximum torque is 6 Nm.



9

Mount weld cable

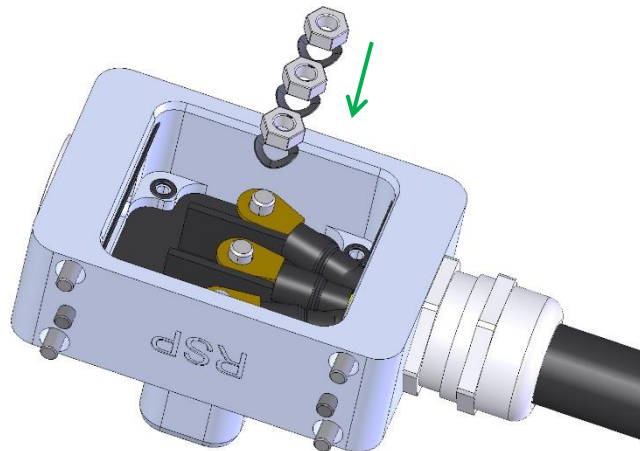

Mount the cable lugs of the weld cable with washers and three M8 nuts

NOTE! Maximum torque is 6 Nm.



10

Mount rear cover

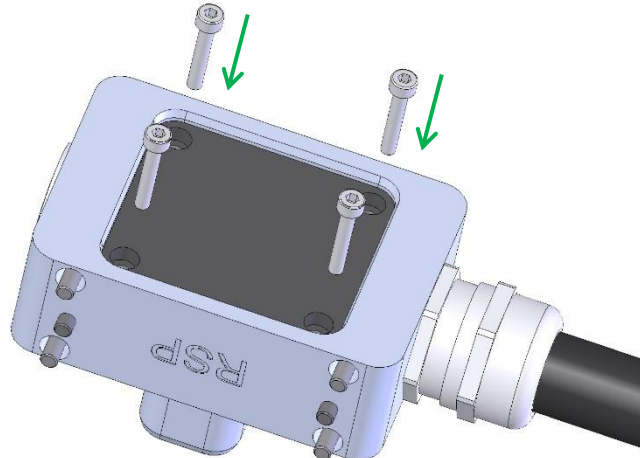

Mount the rear cover with the four M5 screws.



NOTE! Be careful not to damage the O-ring.

NOTE! Apply a small amount of grease (Electrolube SGB) on the weld power pins.

6.3.8 Replacement of air sealings

Replace air sealings when damaged.

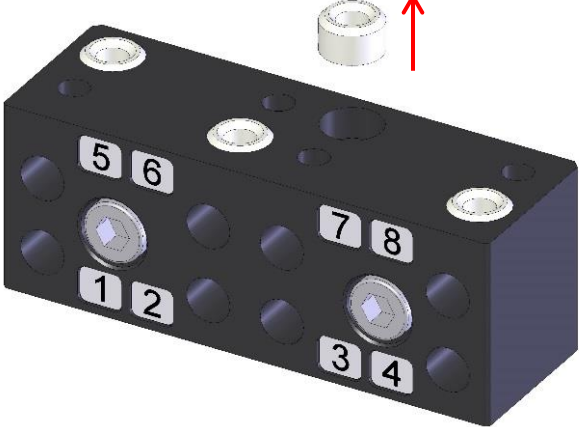

	Action	Note
1	Air off	Switch off pneumatic air.
2	Remove air sealings 	Remove the air sealings with a screw driver. NOTE! There are totally 4 air sealings on each unit.
3	Clean sealing holes 	Remove all remaining parts of the sealing.
4	Mount new air sealings 	Tap in the air sealings with a plastic mallet.
5	Air on	Switch on pneumatic air.

6.3.9 Replacement of O-rings on signal modules

Replace O-rings when worn-out or damaged.

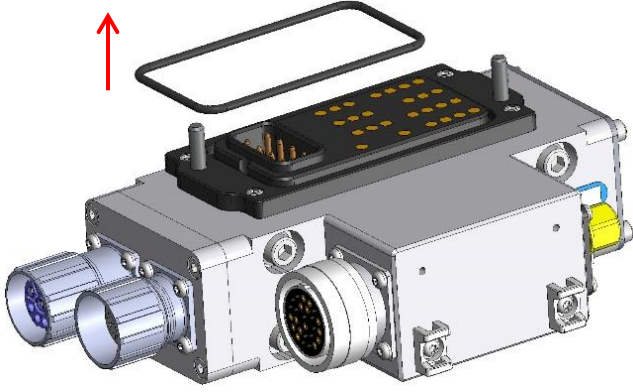
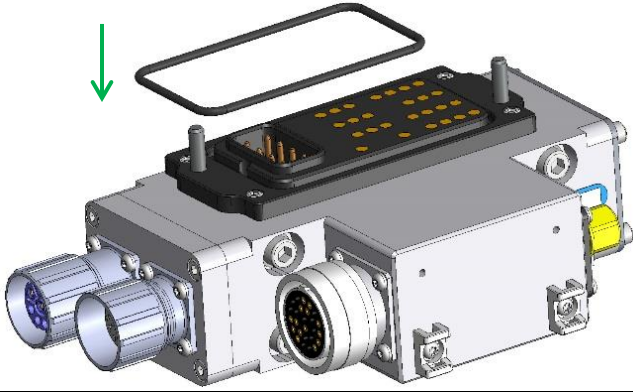
	Action	Note
1	Remove O-rings 	Remove the O-ring/O-rings on the tool attachments signal contact.
2	Replace O-rings 	Put small amount of grease (Magnalube-G) on the new O-rings before they are mounted.

6.3.10 Replacement of electric modules on tool changer or tool attachment

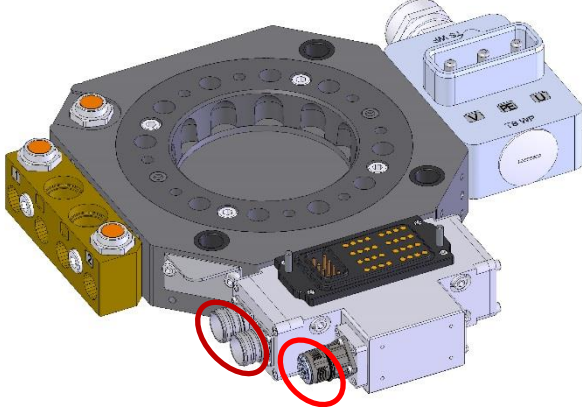
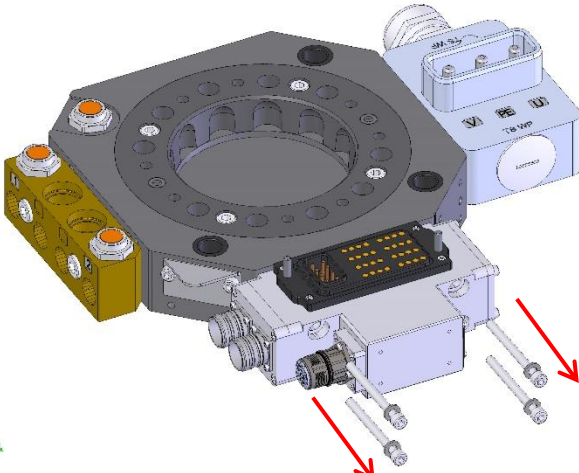
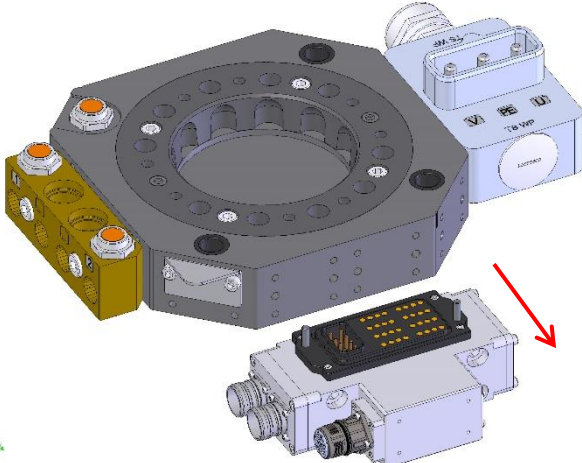

	Action	Note
1	<p>Disconnect electric connections</p> 	<p>Disconnect electrical and field bus connectors from the module.</p> <p>NOTE! Handle contacts with care, as they are sensitive to mechanical damage. Make sure that no dirt enters the contacts.</p>
2	<p>Release module</p> 	<p>Unscrew and remove the four M6-screws holding the module.</p> <p>WARNING! The module may be heavy and may cause personal injury and equipment damage if dropped.</p>
3	<p>Remove module</p> 	<p>Remove the module from the tool changer/tool attachment.</p> <p>NOTE! Guide pins may be mounted between the module and the tool changer/tool attachment.</p> <p>NOTE! Clean the surface of the tool changer/tool attachment where the module was mounted.</p>
4	<p>Mount replacement module</p>	<p>Follow the instructions in section 2.4.</p>

6.3.11 Replacement of water/air modules on tool changer or tool attachment

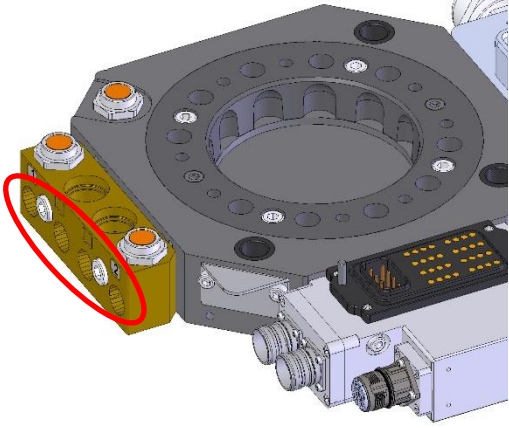
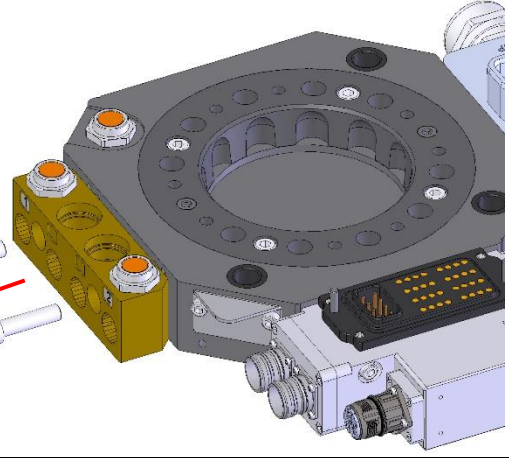
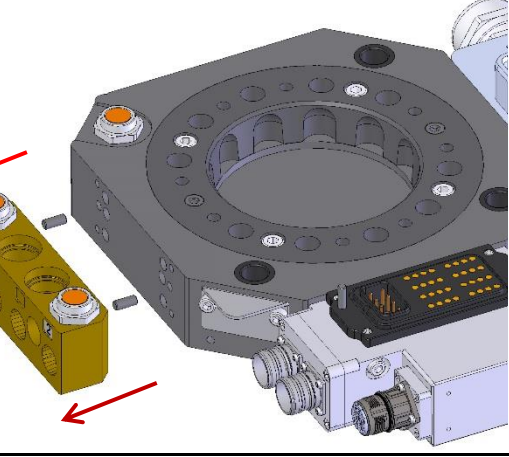
	Action	Note
1	Disconnect air/water 	Disconnect air and water hoses from the air/water-module.
2	Release module 	Unscrew and remove the two M10-screws holding the module. WARNING! The module may be heavy and may cause personal injury and equipment damage if dropped.
3	Remove module 	Remove the module from the tool changer/tool attachment. NOTE! Guide pins may be mounted between the module and the tool changer/tool attachment. NOTE! Clean the surface of the tool changer/tool attachment where the module was mounted.
4	Mount replacement module	Follow the instructions in section 2.5.



7 DISPOSAL AND RECYCLING

Taking care of spent equipment

Used equipment must be taken care of in an environmentally-friendly way.

When disposed of, a major share of the material, or its energy content, can be recycled. The quantities possible to recycle vary depending on technical resources and practises in respective country. Non-recyclable components shall be handed over to an authorized environmental waste treatment facility for destruction or disposal.

Electronics

Electronic equipment shall be sent to an authorized recycling company or sorted into different component materials and treated as such.

Metals

Metals can, in general, be melted down, recycled and used in new products. They shall be sorted according to type and surface coating and handed over to an authorized recycling facility.

Metal components of steel and aluminium are substantial in size and easy to identify. Copper is primarily used in transmission of power for spot welding. Silver or gold plating of contact surfaces may occur.

Plastics

Thermoplastics can, in general, be re-heated and recycled without any major loss of quality. They shall be handed over to an authorized recycling facility. POM occurs in swivel housings, etc. PTFE in some sealings.

Rubber

Rubber shall be handed over to an authorized environmental waste treatment facility either for recycling, disposal or destruction. Rubber occurs in O-rings.

Other material

All other material shall be sorted and handed to an authorized environmental waste treatment facility in accordance with national legislation.

