

SITOP power supply

SITOP PSU6200 1ph

Equipment Manual

SITOP PSU6200 12 V/7 A
6EP3323-7SB00-0AX0
SITOP PSU6200 12 V/12 A
6EP3324-7SB00-3AX0
SITOP PSU6200 24 V/3.7 A
6EP3333-7LB00-0AX0
SITOP PSU6200 24 V/5 A
6EP3333-7SB00-0AX0
SITOP PSU6200 24 V/10 A
6EP3334-7SB00-3AX0
SITOP PSU6200 24 V/20 A
6EP3336-7SB00-3AX0
SITOP PSU6200 48 V/5 A
6EP3344-7SB00-3AX0
SITOP PSU6200 48 V/10 A
6EP3346-7SB00-3AX0

SITOP PSU6200 Ex 24 V/5 A
6EP3333-7SC00-0AX0
SITOP PSU6200 Ex 24 V/10 A
6EP3334-7SC00-3AX0
SITOP PSU6200 Ex 24 V/20 A
6EP3336-7SC00-3AX0

Overview

Safety instructions

1

Description, device design,
dimension drawing

2

Mounting/removal

3

Mounting position,
mounting clearances

4

Installation

5

Technical data

6

Safety, approvals, EMC

7

Ambient conditions

8

Applications

9

Environment

10



Service & Support

11

Legal information

Warning notice system

This manual contains notices you have to observe in order to ensure your personal safety, as well as to prevent damage to property. The notices referring to your personal safety are highlighted in the manual by a safety alert symbol, notices referring only to property damage have no safety alert symbol. These notices shown below are graded according to the degree of danger.

 DANGER
indicates that death or severe personal injury will result if proper precautions are not taken.
 WARNING
indicates that death or severe personal injury may result if proper precautions are not taken.
 CAUTION
indicates that minor personal injury can result if proper precautions are not taken.
NOTICE
indicates that property damage can result if proper precautions are not taken.

If more than one degree of danger is present, the warning notice representing the highest degree of danger will be used. A notice warning of injury to persons with a safety alert symbol may also include a warning relating to property damage.

Qualified Personnel

The product/system described in this documentation may be operated only by **personnel qualified** for the specific task in accordance with the relevant documentation, in particular its warning notices and safety instructions. Qualified personnel are those who, based on their training and experience, are capable of identifying risks and avoiding potential hazards when working with these products/systems.

Proper use of Siemens products

Note the following:

 WARNING
Siemens products may only be used for the applications described in the catalog and in the relevant technical documentation. If products and components from other manufacturers are used, these must be recommended or approved by Siemens. Proper transport, storage, installation, assembly, commissioning, operation and maintenance are required to ensure that the products operate safely and without any problems. The permissible ambient conditions must be complied with. The information in the relevant documentation must be observed.

Trademarks

All names identified by ® are registered trademarks of Siemens AG. The remaining trademarks in this publication may be trademarks whose use by third parties for their own purposes could violate the rights of the owner.

Disclaimer of Liability

We have reviewed the contents of this publication to ensure consistency with the hardware and software described. Since variance cannot be precluded entirely, we cannot guarantee full consistency. However, the information in this publication is reviewed regularly and any necessary corrections are included in subsequent editions.

Overview



The 1-phase SITOP PSU6200 from the product line is a powerful, regulated standard power supply for automated machines and systems. In addition to a high efficiency, these low-profile power supply units have an outstanding overload behavior.

The key benefits of the product include:

- Wide-range input that allows it to be connected to almost any 1-phase line supply around the world – or to a DC power source
- The output voltage can be set in the range 12 V - 15.5 V respectively 24 V - 28 V or 48 V - 56 V
- Brief overload capability of 150% for 5 s/min (extra power)
- Continuous overload capability of 120% up to an ambient temperature of 45 °C
- Integrated signaling contact for "12 V O.K.", respectively "24 V O.K." or "48 V O.K."
- Push-in connections facilitate fast wiring
- Diagnostic monitor with utilization and service life display using LEDs
- Diagnostics interface to connect to the automation system via only one digital PLC input
- Ambient temperature -30 °C ... 70 °C, for 12 V devices and 24 V/3.7 A and 24 V/5 A -25 °C ... 70 °C
- To increase the system availability, these reliable power supplies can be expanded using SITOP supplementary modules (redundancy module, selectivity module, buffer module), as well as SITOP DC-UPS modules.

Ordering data

The following device options are available:

Regulated power supply unit SITOP PSU6200	
Type	Order number
Input 1 AC 120/240 V, 110 - 240 V DC Output 12 V DC/7 A	6EP3323-7SB00-0AX0
Input 1 AC 120/240 V, 110 - 240 V DC Output 12 V DC/12 A	6EP3324-7SB00-3AX0
Input 1 AC 120/240 V, 120 - 240 V DC Output 24 V DC/3.7 A	6EP3333-7LB00-0AX0
Input 1 AC 120/240 V, 120 - 240 V DC Output 24 V DC/5 A	6EP3333-7SB00-0AX0
Input 1 AC 120/240 V, 120 - 240 V DC Output 24 V DC/10 A	6EP3334-7SB00-3AX0
Input 1 AC 120/240 V, 120 - 240 V DC Output 24 V DC/20 A	6EP3336-7SB00-3AX0
Input 1 AC 120/240 V, 110 - 240 V DC Output 48 V DC/5 A	6EP3344-7SB00-3AX0
Input 1 AC 120/240 V, 110 - 240 V DC Output 48 V DC/10 A	6EP3346-7SB00-3AX0

Regulated power supply unit SITOP PSU6200 Ex	
Type	Order number
Input 1 AC 120/240 V, 120 - 240 V DC Output 24 V DC/5 A	6EP3333-7SC00-0AX0
Input 1 AC 120/240 V, 120 - 240 V DC Output 24 V DC/10 A	6EP3334-7SC00-3AX0
Input 1 AC 120/240 V, 120 - 240 V DC Output 24 V DC/20 A	6EP3336-7SC00-3AX0

Accessories	
Type	Order number
Reference labeling plate (160 plates)	6ES7193-6LF30-0AW0

Table of contents

- Overview..... 3**
- 1 Safety instructions..... 7**
 - 1.1 General safety instructions..... 7
 - 1.2 Safety instructions for hazardous zones..... 8
- 2 Description, device design, dimension drawing 9**
 - 2.1 Device description 9
 - 2.2 Connections and terminal designation 10
 - 2.3 Potentiometer 11
 - 2.4 Status displays and signaling..... 13
 - 2.5 Operating mode 16
 - 2.6 Block diagram 17
 - 2.7 Dimensions and weight 19
- 3 Mounting/removal 21**
- 4 Mounting position, mounting clearances 23**
 - 4.1 Standard mounting position..... 23
 - 4.2 Other mounting positions 27
 - 4.2.1 6EP3323-7SB00-0AX0..... 27
 - 4.2.2 6EP3324-7SB00-3AX0..... 29
 - 4.2.3 6EP3333-7LB00-0AX0..... 31
 - 4.2.4 6EP3333-7SB00-0AX0 and 6EP3333-7SC00-0AX0 33
 - 4.2.5 6EP3334-7SB00-3AX0 and 6EP3334-7SC00-3AX0 35
 - 4.2.6 6EP3336-7SB00-3AX0 and 6EP3336-7SC00-3AX0 37
 - 4.2.7 6EP3344-7SB00-3AX0..... 39
 - 4.2.8 6EP3346-7SB00-3AX0..... 41
- 5 Installation..... 43**
 - 5.1 Line-side connection..... 43
 - 5.2 Output-side connection 45
- 6 Technical data..... 47**
 - 6.1 Input 47
 - 6.2 Output 50
 - 6.3 Efficiency..... 59
 - 6.4 Closed-loop control..... 64
 - 6.5 Protection and monitoring 66
 - 6.6 MTBF..... 67

6.7	Mechanical system	68
6.8	Accessories	71
6.9	Dimension drawing.....	72
7	Safety, approvals, EMC.....	73
7.1	Safety.....	73
7.2	Test voltage.....	74
7.3	Approvals	75
7.4	EMC	76
8	Ambient conditions	77
9	Applications	79
9.1	Parallel connection to increase the power rating	79
9.2	Series connection for increased voltage	81
9.3	Overload protection in the 24 V output circuit.....	83
9.4	Protection against short-time voltage dips.....	84
9.5	Protecting against longer power failures	85
10	Environment	87
11	Service & Support	89

Safety instructions

1.1 General safety instructions



WARNING

Correct handling of the devices

When operating electrical devices, it is inevitable that certain components will carry dangerous voltages.

Therefore, failure to handle the units properly can result in death or serious physical injury as well as extensive property damage.

Only appropriately qualified personnel may work on or in the vicinity of this equipment.

Perfect, safe, and reliable operation of this equipment is dependent on proper transportation, storage, installation and mounting.

Before installation or maintenance work can begin, the system's main switch must be switched off and measures taken to prevent it being switched on again.

If this instruction is not observed, touching live parts can result in death or serious injury.

1.2 Safety instructions for hazardous zones

It is permissible that the following devices are used in hazardous zones:

Type	Order number
SITOP PSU6200 Ex 24 V/5 A	6EP3333-7SC00-0AX0
SITOP PSU6200 Ex 24 V/10 A	6EP3334-7SC00-3AX0
SITOP PSU6200 Ex 24 V/20 A	6EP3336-7SC00-3AX0

The devices comply with ATEX directive 2014/34/EU; EN 60079-0; EN 60079-7.

 **WARNING**

OPERATE VOLTAGE ADJUSTMENT IN NON-HAZARDOUS AREAS ONLY!

 **WARNING**

EXPLOSION HAZARD – DO NOT CONNECT OR DISCONNECT EQUIPMENT UNLESS POWER HAS BEEN SWITCHED OFF OR THE AREA IS KNOWN TO BE NON-HAZARDOUS

Description, device design, dimension drawing

2.1 Device description

SITOP PSU6200 is a primary-clocked power supply for connection to a 1-phase AC line supply and a DC supply. An electronically regulated DC voltage that can be set via a potentiometer is available at the output of the device. The output of the device is isolated, no-load proof and short-circuit proof. The LED display indicates the operating status. The operating state of the device can be processed via the signaling contact.

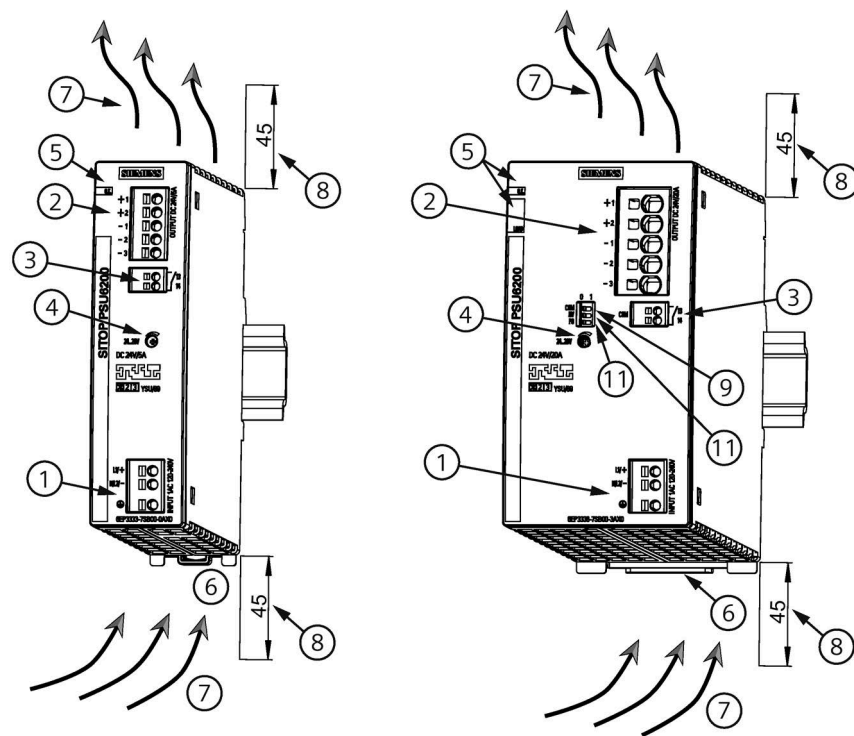

- ① AC/DC input
- ② DC output
- ③ Signaling contact (13, 14)
- ④ Potentiometer 12 V - 15.5 V, 24 V - 28 V or 48 V - 56 V
- ⑤ Indicator light, diagnostics monitor (O.K., LOAD)
- ⑥ DIN rail slider
- ⑦ Convection
- ⑧ Clearance above/below
- ⑨ Diagnostics interface (COM)
- ⑩ DC voltage level increase (HV)
- ⑪ Parallel operation (PO)

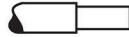



Figure 2-1 Design

2.2 Connections and terminal designation

The line input terminals ① can be used to establish the connection to the supply voltage. The output terminals ② are used to connect to the loads to be supplied (see also Chapter Installation (Page 43)).





The operating state of the device can be processed via the signaling contact ③ (function and contact rating, see Chapter Status displays and signaling (Page 13)).

Connections and terminal designations	
① Line input L1, N (L2), PE	one spring-loaded terminal each
② Output +	2 spring-loaded terminals
② Output -	3 spring-loaded terminals
③ Signaling contact 13, 14	one spring-loaded terminal each

	① + ②	③	④
	0,6 x 3,5	0,6 x 3,5	0,6 x 3 / PZ1 / PH1 max. Ø 3,5 mm
	1 x 0,2 - 4 mm ²	1 x 0,2 - 1,5 mm ²	-
	1 x 0,2 - 2,5 mm ²	1 x 0,2 - 1,5 mm ²	-
	1 x 0,25 - 2,5 mm ²	1 x 0,25 - 1,5 mm ²	-
AWG	24 - 12	24 - 16	-
Nm	-	-	0,04 Nm ^{*1)}
	10 mm	10 mm	-

*1) Do not subject the end stop to higher loads

Figure 2-2 Terminal data for 6EP3323-7SB00-0AX0, 6EP3324-7SB00-3AX0, 6EP3333-7LB00-0AX0, 6EP3333-7SB00-0AX0, 6EP3334-7SB00-3AX0, 6EP3344-7SB00-3AX0 and 6EP3333-7SC00-0AX0, 6EP3334-7SC00-3AX0

	①	②	③	④
	0,6 x 3,5	0,6 x 3,5	0,6 x 3,5	0,6 x 3 / PZ1 / PH1 max. Ø 3,5 mm
	1 x 0,2 - 4 mm ²	1 x 0,2 - 10 mm ²	1 x 0,2 - 1,5 mm ²	-
	1 x 0,2 - 2,5 mm ²	1 x 0,5 - 6 mm ²	1 x 0,2 - 1,5 mm ²	-
	1 x 0,25 - 2,5 mm ²	1 x 0,5 - 6 mm ²	1 x 0,25 - 1,5 mm ²	-
AWG	24 - 12	24 - 8	24 - 16	-
Nm	-	-	-	0,04 Nm ^{*1)}
	10 mm	15 mm	10 mm	-

*1) Do not subject the end stop to higher loads

Figure 2-3 Terminal data for 6EP3336-7SB00-3AX0, 6EP3346-7SB00-3AX0 and 6EP3336-7SC00-3AX0

2.3 Potentiometer

The potentiometer ④ on the front of the device is used to adjust the output voltage. The output voltage is set to the rated value at the factory and can be set within certain limits; for example, to compensate voltage drops across long supply lines to the connected load.

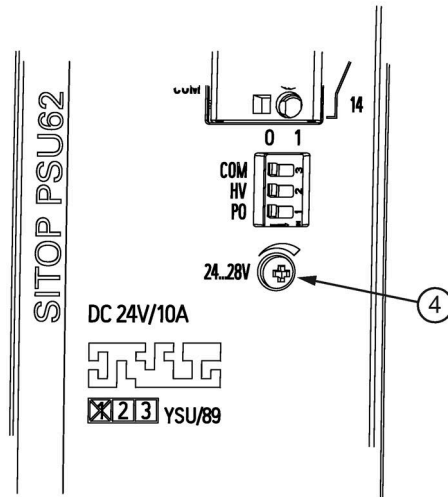

Figure 2-4 Potentiometer

Type	Factory setting	Adjustment range
6EP3323-7SB00-0AX0 6EP3324-7SB00-3AX0	12 V	12 V - 15.5 V
6EP3333-7LB00-0AX0 6EP3333-7SB00-0AX0 6EP3333-7SC00-0AX0 6EP3334-7SB00-3AX0 6EP3334-7SC00-3AX0 6EP3336-7SB00-3AX0 6EP3336-7SC00-3AX0	24 V	24 V - 28 V
6EP3344-7SB00-3AX0 6EP3346-7SB00-3AX0	48 V	48 V - 56 V

NOTICE

Thermal overload possible

When adjusting the output voltage to higher than the rated voltage, the output current must be derated by 8 %/V (for devices with a rated output voltage of 12 V), 4 %/V (for devices with a rated output voltage of 24 V) and 2 %/V (for devices with a rated output voltage of 48 V), or take into account the permissible ambient temperature of 3 °C/V.

Note

It is only permissible to use an insulated screwdriver when actuating the potentiometer.

2.3 Potentiometer

For information on actuating the potentiometer (screwdriver, torque), see Connections and terminal designation (Page 10).

2.4 Status displays and signaling

	6EP3323-7SB00-0AX0 (12 V/7 A) 6EP3324-7SB00-3AX0 (12 V/12 A)	6EP3333-7LB00-0AX0 (24 V/3.7 A) 6EP3333-7SB00-0AX0 6EP3333-7SC00-0AX0 (24 V/5 A) 6EP3334-7SB00-3AX0 6EP3334-7SC00-3AX0 (24 V/10 A) 6EP3336-7SB00-3AX0 6EP3336-7SC00-3AX0 (24 V/20 A)	6EP3344-7SB00-3AX0 (48 V/5 A) 6EP3346-7SB00-3AX0 (48 V/10 A)
Status display	LED green for 12 V O.K. LED yellow	LED green for 24 V O.K. LED yellow	LED green for 48 V O.K. LED yellow
Signaling contact (13, 14)	Relay contact (NO contact, isolated (SELV (ES1) must be complied with), contact rating 30 V DC/0.1 A)		

Device without diagnostics monitor

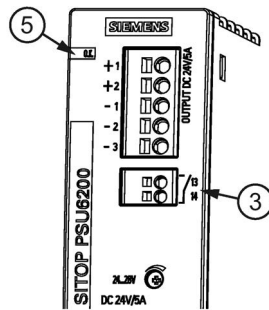

Figure 2-5 Signaling, signaling contact

Signaling signaling contact	6EP3323-7SB00-0AX0 (12 V/7 A)	6EP3333-7LB00-0AX0 (24 V/3.7 A) 6EP3333-7SB00-0AX0 6EP3333-7SC00-0AX0 (24 V/5 A)
LED "O.K.":		
<i>green:</i>	Output voltage $U_{out} > 10$ V or $U_{out} > 11.8$ V	Output voltage $U_{out} > 20$ V or $U_{out} > 23$ V
<i>green flashing (0.5 Hz):</i>	shutdown as a result of thermal overload	shutdown as a result of thermal overload
Signaling contact (13, 14) closed:	Output voltage $U_{out} > 10$ V NOTICE: It is not permissible that the signaling contact is connected on the primary side!	Output voltage $U_{out} > 20$ V NOTICE: It is not permissible that the signaling contact is connected on the primary side!

Device with diagnostics monitor

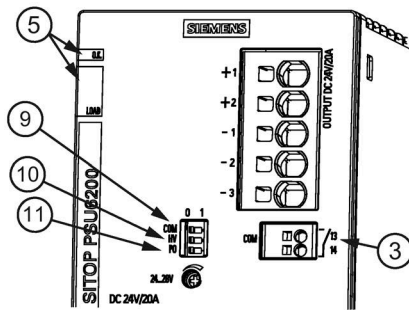
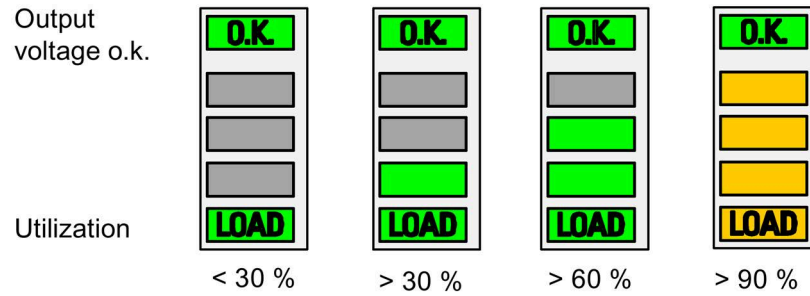

Figure 2-6 Signaling, signaling contact

Signaling signaling contact	6EP3324-7SB00-3AX0 (12 V/12 A)	6EP3334-7SB00-3AX0 6EP3334-7SC00-3AX0 (24 V/10 A) 6EP3336-7SB00-3AX0 6EP3336-7SC00-3AX0 (24 V/20 A)	6EP3344-7SB00-3AX0 (48 V/5 A) 6EP3346-7SB00-3AX0 (48 V/10 A)
LED "O.K.":			
<i>green:</i>	Output voltage $U_{out} > 10\text{ V}$ or $U_{out} > 11.8\text{ V}$	Output voltage $U_{out} > 20\text{ V}$ or $U_{out} > 23\text{ V}$	Output voltage $U_{out} > 43\text{ V}$ or $U_{out} > 46\text{ V}$
<i>green flashing (0.5 Hz):</i>	shutdown as a result of thermal overload	shutdown as a result of thermal overload	shutdown as a result of thermal overload
LED "LOAD":			
<i>green:</i>	reached service life $< 90\%$	reached service life $< 90\%$	reached service life $< 90\%$
<i>yellow:</i>	reached service life $\geq 90\%$; $I_{out\ rated} \geq 90\%$	reached service life $\geq 90\%$; $I_{out\ rated} \geq 90\%$	reached service life $\geq 90\%$; $I_{out\ rated} \geq 90\%$
LEDs above LED "LOAD":			
<i>LED 5.1 green:</i>	$I_{out\ rated} 30 - 60\%$	$I_{out\ rated} 30 - 60\%$	$I_{out\ rated} 30 - 60\%$
<i>LEDs 5.1+5.2 green:</i>	$I_{out\ rated} 60 - 90\%$	$I_{out\ rated} 60 - 90\%$	$I_{out\ rated} 60 - 90\%$
<i>LEDs 5.1+5.2+5.3 yellow:</i>	$I_{out\ rated} > 90\%$	$I_{out\ rated} > 90\%$	$I_{out\ rated} > 90\%$
Contact "COM" (13, 14): <i>closed:</i>	Output voltage $U_{out} > 10\text{ V}$ or $U_{out} > 11.8\text{ V}$; alternative data transfer (DIP switch COM = 1) NOTICE: It is not permissible that the contact is connected on the primary side!	Output voltage $U_{out} > 20\text{ V}$ or $U_{out} > 23\text{ V}$; alternative data transfer (DIP switch COM = 1) NOTICE: It is not permissible that the contact is connected on the primary side!	Output voltage $U_{out} > 43\text{ V}$ or $U_{out} > 46\text{ V}$; alternative data transfer (DIP switch COM = 1) NOTICE: It is not permissible that the contact is connected on the primary side!

Diagnostic monitor display:



Service life < 10 %

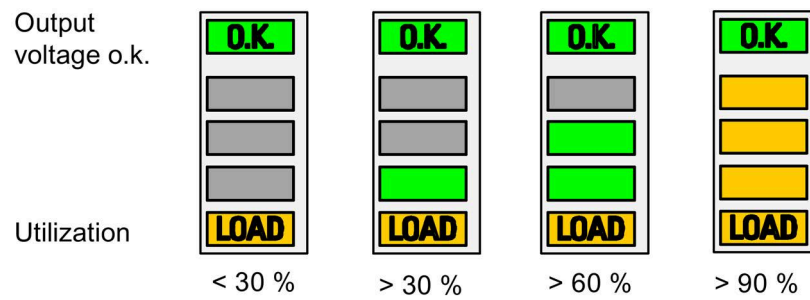

2.5 Operating mode

The selection is made using individual DIP switches (when supplied, these are in the 0 position).

It is only permissible to connect two identical devices in parallel to increase the power by changing over the output characteristic using selector switch PO ⑾ to 1

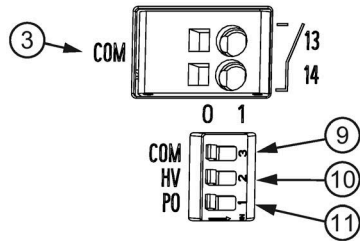

DIP switch	6EP3324-7SB00-3AX0 (12 V/12 A)	6EP3334-7SB00-3AX0 6EP3334-7SC00-3AX0 (24 V/10 A) 6EP3336-7SB00-3AX0 6EP3336-7SC00-3AX0 (24 V/20 A)	6EP3344-7SB00-3AX0 (48 V/5 A) 6EP3346-7SB00-3AX0 (48 V/10 A)
COM ⑨:	Selector switch to toggle between the U_{out} status display and the communication 0: Display of the output voltage status 1: Internal device parameters are transferred via signaling contact (13, 14) (diagnostics interface) NOTICE: It is not permissible that the signaling contact is connected on the primary side! Contact rating: 30 V DC/0.1 A		
HV ⑩:	Setting, above which the "O.K." LED is lit 0: > 10 V 1: > 11.8 V	Setting, above which the "O.K." LED is lit 0: > 20 V 1: > 23 V	Setting, above which the "O.K." LED is lit 0: > 43 V 1: > 46 V
PO ⑾:	Switching over the output characteristic 0: Constant output voltage "single operation" 1: Load-dependent output voltage "parallel operation"		

Additional information can be found in the documents:

- Diagnostics interface (<https://support.industry.siemens.com/cs/ww/en/view/109763467>)
- Faceplates and communication blocks (<https://support.industry.siemens.com/cs/ww/en/view/109760217>)

2.6 Block diagram

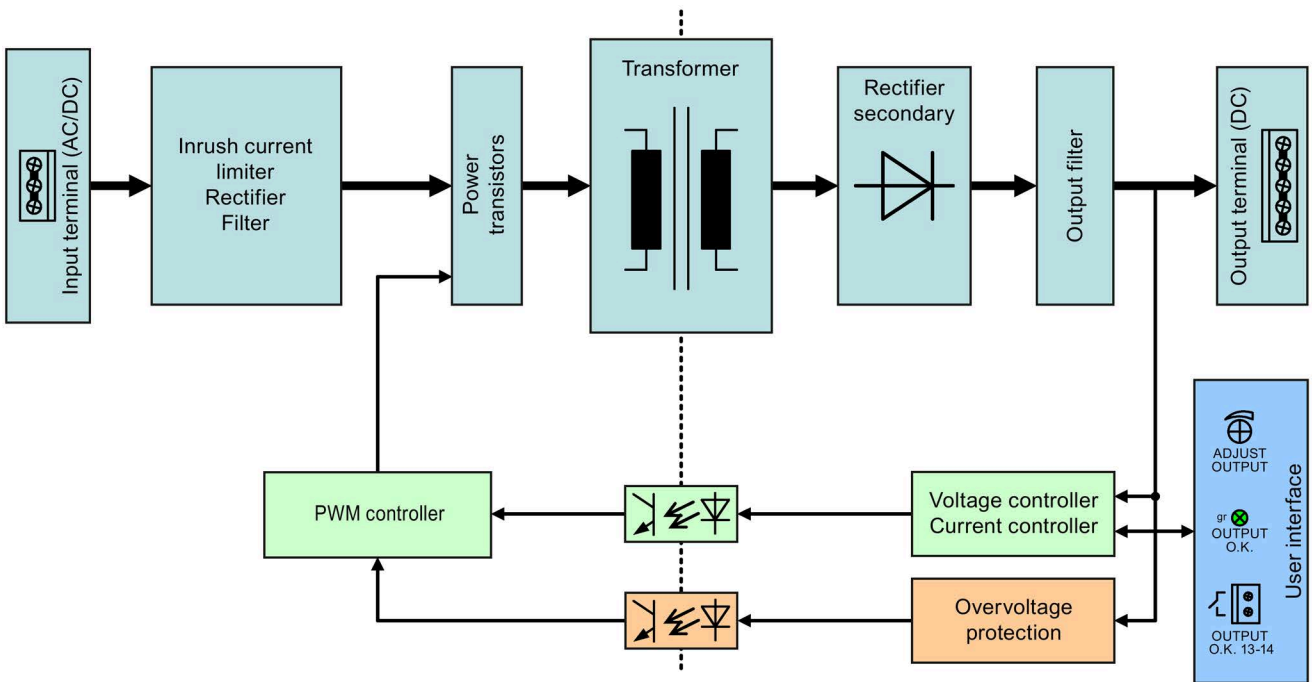

Figure 2-7 Block diagram 12 V/7 A and 24 V/3.7 A, 24 V/5 A devices

2.6 Block diagram

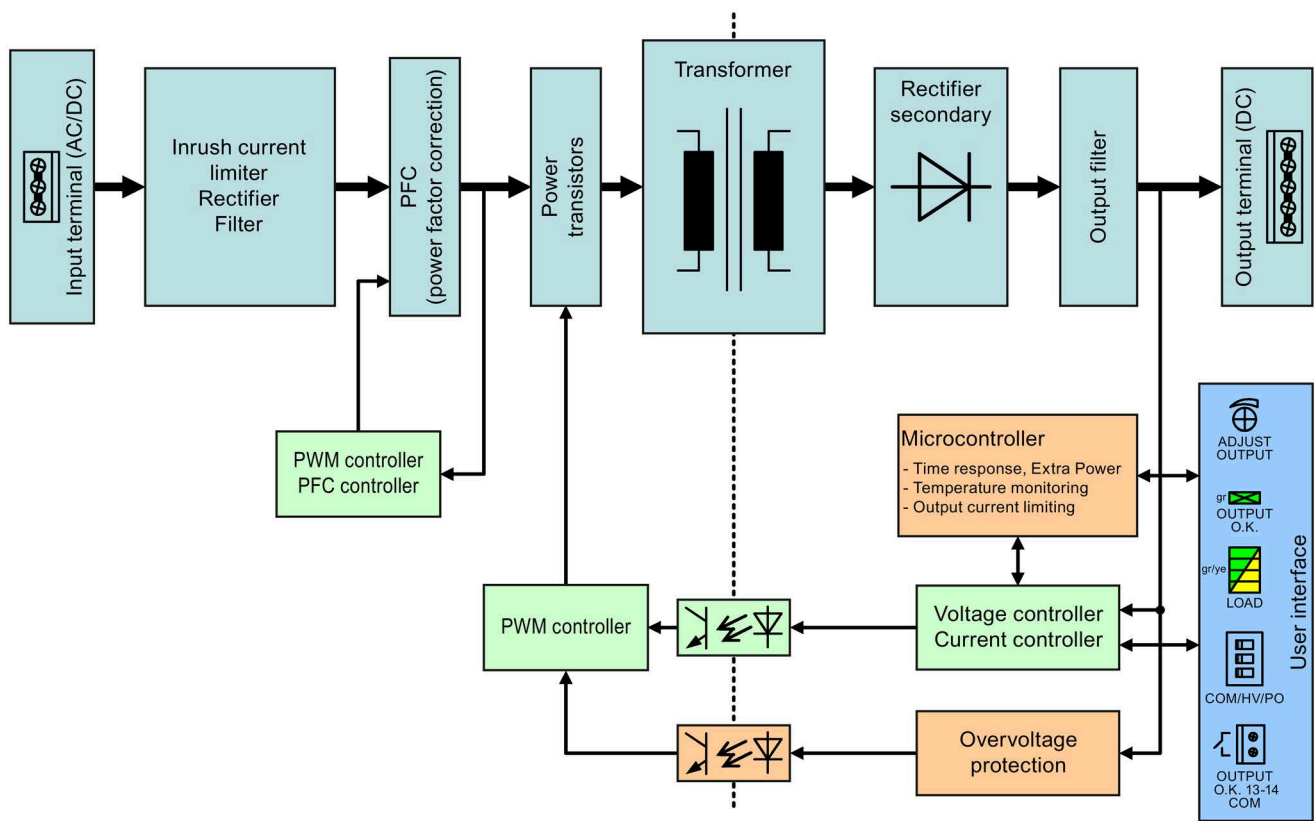

Figure 2-8 Block diagram 12 V/12 A and 24 V/10 A, 24 V/20 A and 48 V/5 A, 48 V/10 A devices

2.7 Dimensions and weight

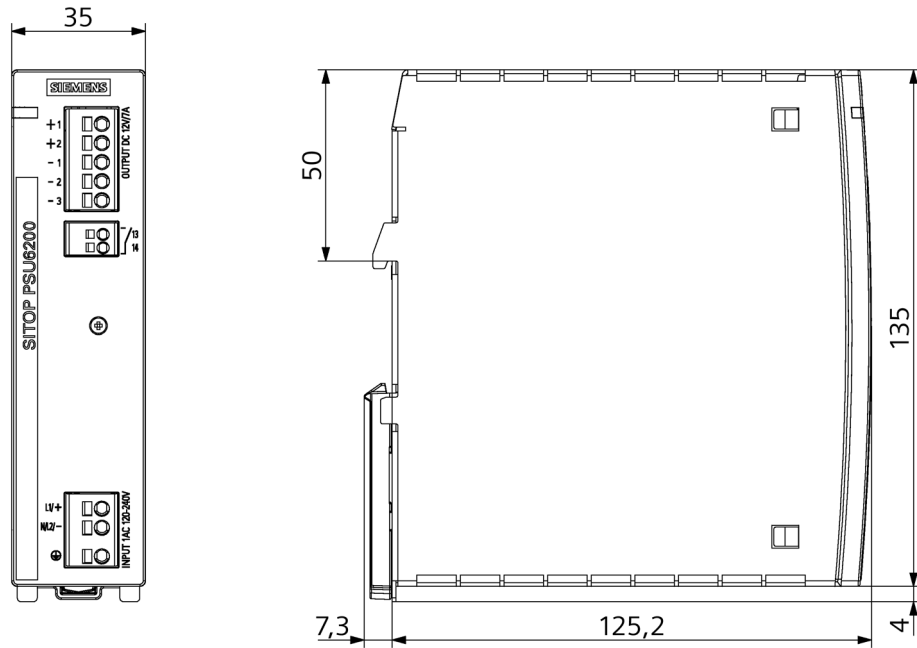

Figure 2-9 Dimension drawing 6EP3323-7SB00-0AX0, 6EP3333-7LB00-0AX0, 6EP3333-7SB00-0AX0 and 6EP3333-7SC00-0AX0

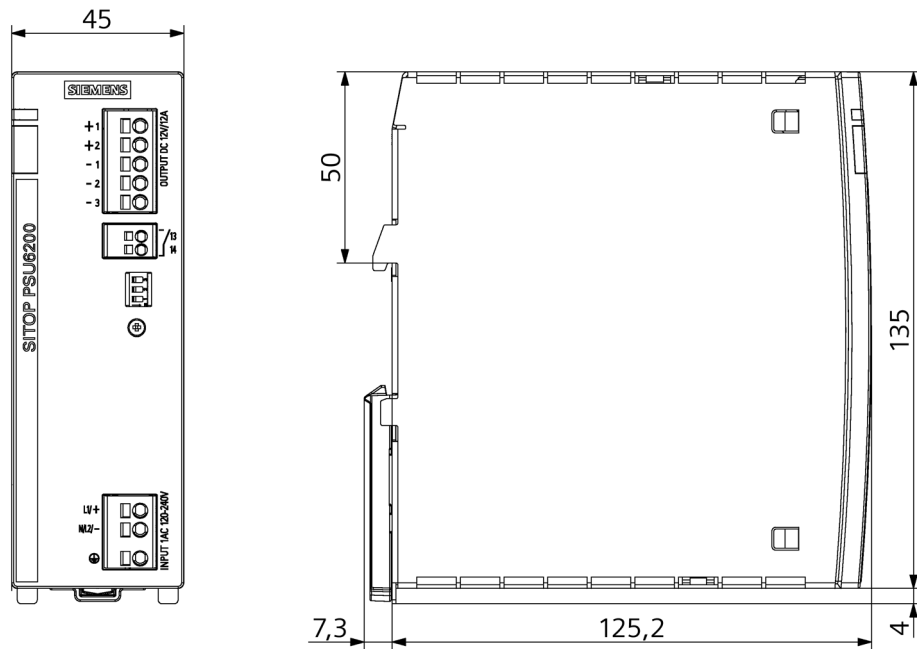

Figure 2-10 Dimension drawing 6EP3324-7SB00-3AX0, 6EP3334-7SB00-3AX0, 6EP3344-7SB00-3AX0 and 6EP3334-7SC00-3AX0

2.7 Dimensions and weight

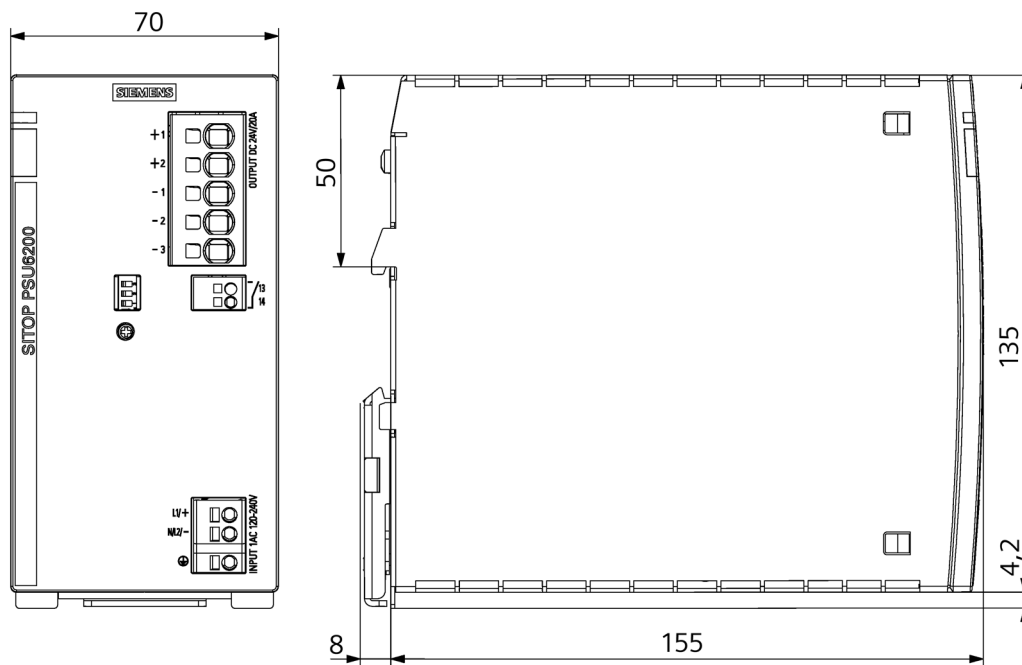

Figure 2-11 Dimension drawing 6EP3336-7SB00-3AX0, 6EP3346-7SB00-3AX0 and 6EP3336-7SC00-3AX0

	6EP3323-7SB00-0AX0 (12 V/7 A)	6EP3324-7SB00-3AX0 (12 V/12 A)
Dimensions (W × H × D) in mm	35 × 135 × 125	45 × 135 × 125
Weight	Approx. 0.7 kg	Approx. 0.9 kg

	6EP3333-7LB00-0AX0 (24 V/3.7 A)	6EP3334-7SB00-3AX0 6EP3334-7SC00-3AX0 (24 V/10 A)	6EP3336-7SB00-3AX0 6EP3336-7SC00-3AX0 (24 V/20 A)
Dimensions (W × H × D) in mm	35 × 135 × 125	45 × 135 × 125	70 × 135 × 155
Weight	Approx. 0.7 kg	Approx. 0.9 kg	Approx. 1.5 kg

	6EP3344-7SB00-3AX0 (48 V/5 A)	6EP3346-7SB00-3AX0 (48 V/10 A)
Dimensions (W × H × D) in mm	45 × 135 × 125	70 × 135 × 155
Weight	Approx. 0.9 kg	Approx. 1.5 kg

Mounting/removal

! WARNING

Installing the device in a housing or a control cabinet

SITOP PSU6200 power supplies are built-in devices. They must be installed in a housing or control cabinet where only qualified personnel have access.

The device can be mounted in a control cabinet on standard mounting rails (see Chapter Mechanical system (Page 68))

Mounting

The device must be mounted in such a way that the input terminals are at the bottom and the output terminals at the top. A clearance of at least 45 mm must be maintained above and below the device (max. cable duct depth 50 mm).

Removal

To remove, pull up the slider ⑥ using a screwdriver and disengage the device at the bottom edge of the standard mounting rail (see Removal diagram (Page 21)). Then you can remove the device from the upper edge of the standard mounting rail.

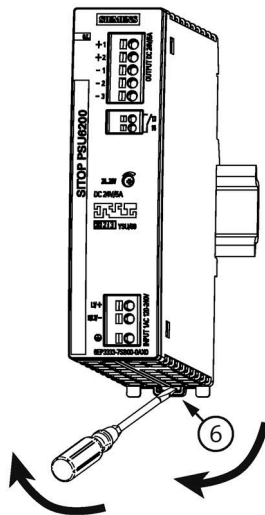

Figure 3-1 Mounting/removal

 **WARNING**

Use in hazardous zones

When installing the device in a hazardous zone (6EP3333-7SC00-0AX0: II 3G Ex ec IIC T3 Gc; 6EP3334-7SC00-3AX0: II 3G Ex ec nC IIC T3 Gc; 6EP3336-7SC00-3AX0: II 3G Ex ec nC IIC T4 Gc) this must be installed in a distribution box with degree of protection IP54 or higher. This distribution box must comply with the requirements laid down in EN 60079-0 and EN 60079-15 and must require a tool for opening.

Mounting position, mounting clearances

4.1 Standard mounting position

The device is mounted on standard mounting rails. The device must be mounted vertically in such a way that the input terminals are at the bottom and the output terminals are at the top to ensure correct cooling.

A clearance of at least 45 mm must always be maintained above and below the device (max. cable channel depth, 50 mm).

Lateral clearances do not have to be maintained.

Output current as a function of the ambient temperature and mounting height

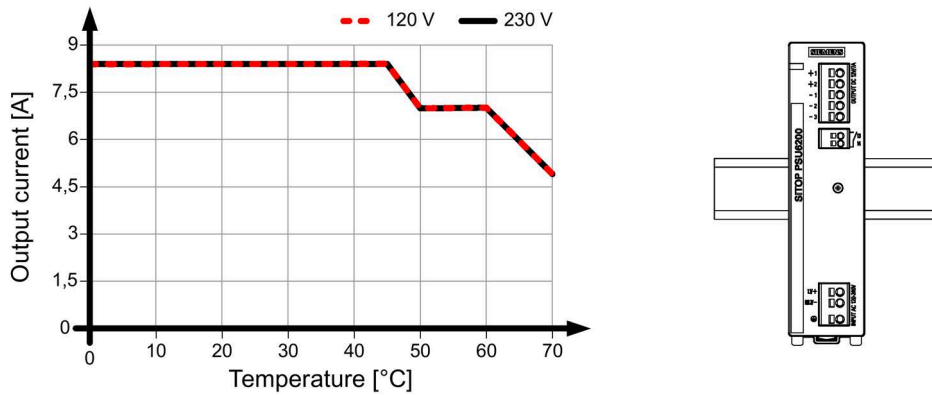

Figure 4-1 6EP3323-7SB00-0AX0 output current for the standard mounting position

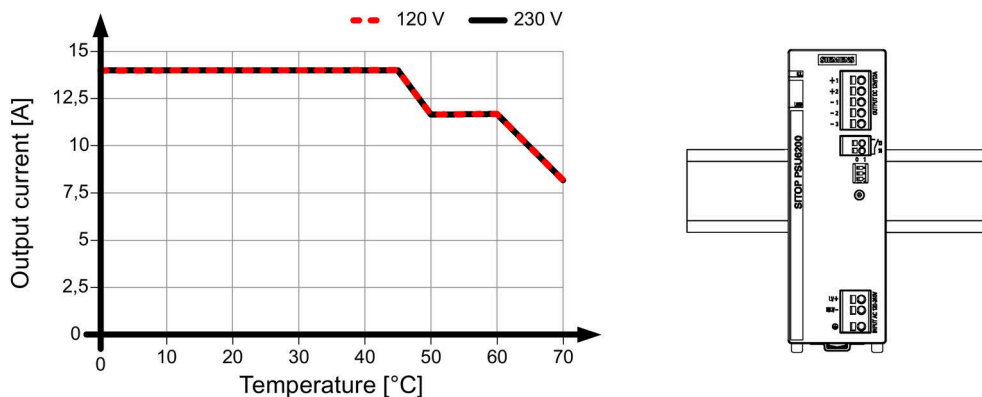

Figure 4-2 6EP3324-7SB00-3AX0 output current for the standard mounting position

4.1 Standard mounting position

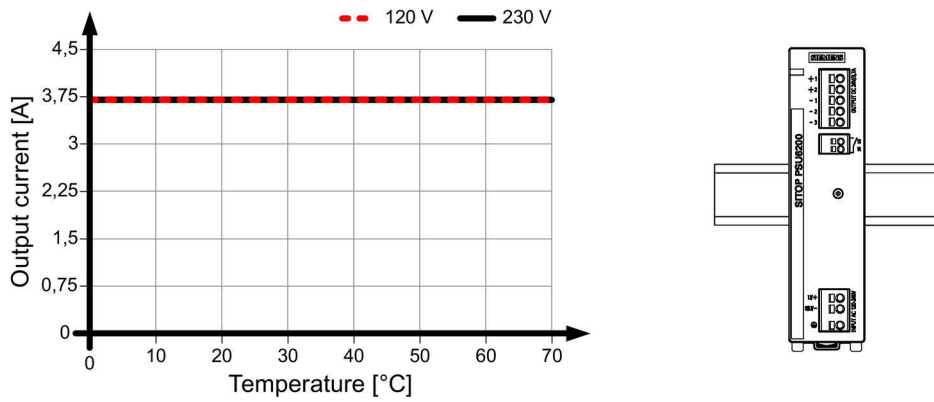

Figure 4-3 6EP3333-7LB00-0AX0 output current for the standard mounting position

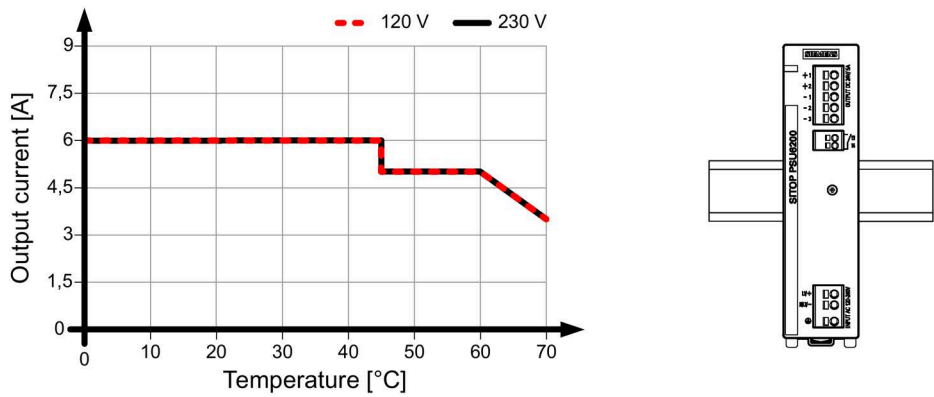

Figure 4-4 6EP3333-7SB00-0AX0 and 6EP3333-7SC00-0AX0 output current for the standard mounting position

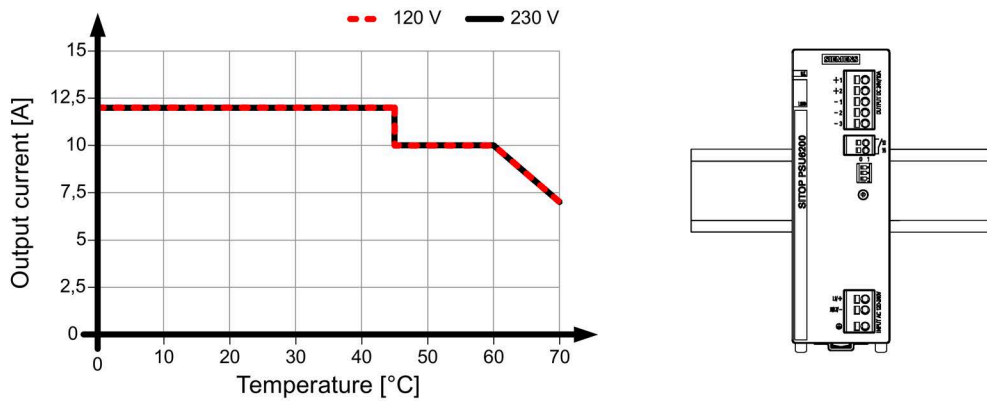

Figure 4-5 6EP3334-7SB00-3AX0 and 6EP3334-7SC00-3AX0 output current for the standard mounting position

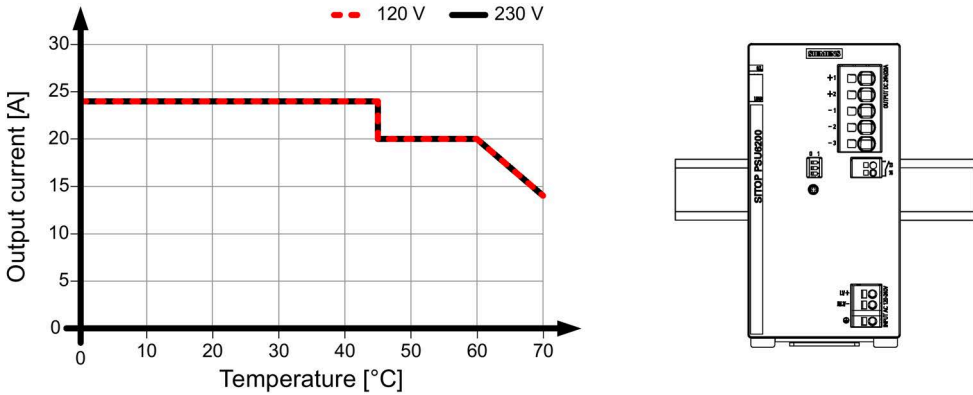

Figure 4-6 6EP3336-7SB00-3AX0 and 6EP3336-7SC00-3AX0 output current for the standard mounting position

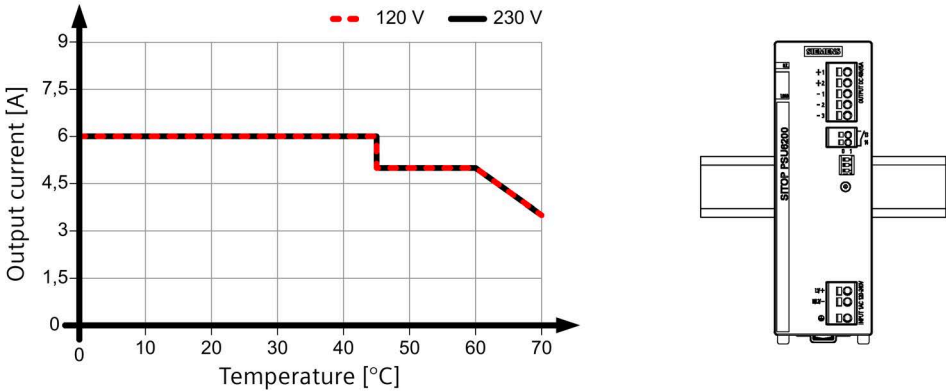

Figure 4-7 6EP3344-7SB00-3AX0 output current for the standard mounting position

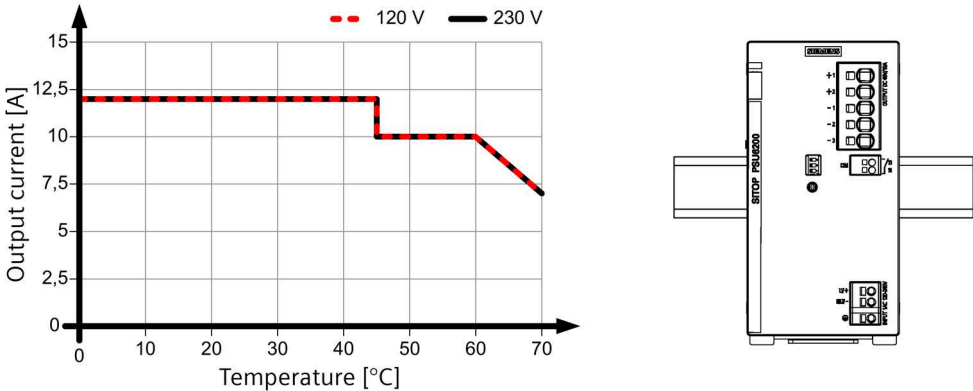

Figure 4-8 6EP3346-7SB00-3AX0 output current for the standard mounting position

4.1 Standard mounting position

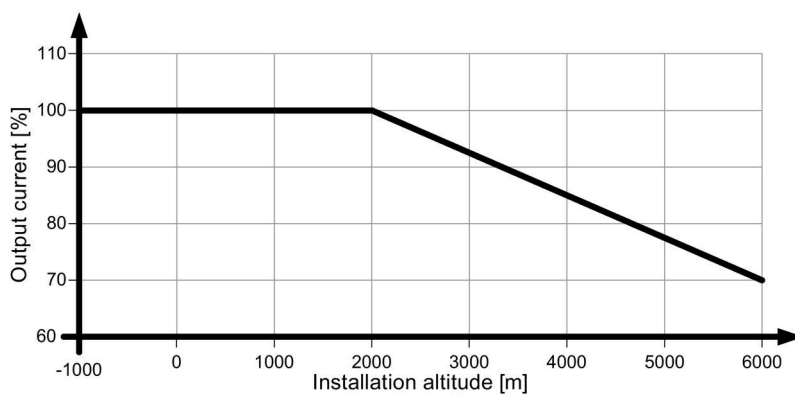

Figure 4-9 Mounting height derating

For details, see Chapter Ambient conditions (Page 77)

4.2 Other mounting positions

For mounting positions that deviate from the standard mounting position, derating factors (reduction of the output power or the permissible ambient temperature) must be observed in accordance with the following diagrams.

Note

In the case of mounting positions that deviate from the standard mounting position, reduced mechanical resistance of the devices against vibration and shock must be expected.

Particularly when installing on a vertically fastened standard mounting rail, additional measures may be required, e.g. to prevent the device from slipping on the standard mounting rail.

4.2.1 6EP3323-7SB00-0AX0

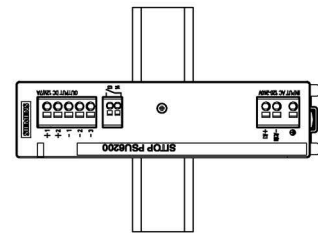
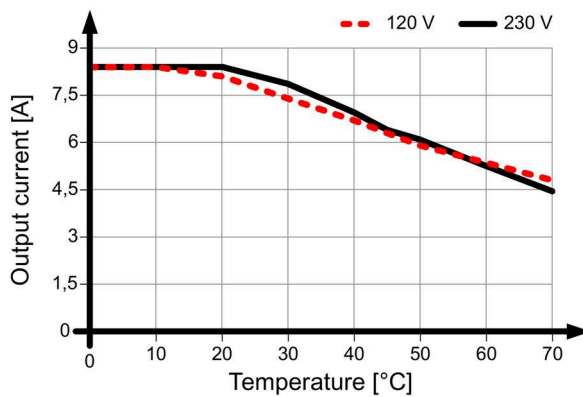

Figure 4-10 Mounting position 1

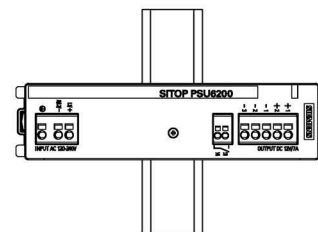
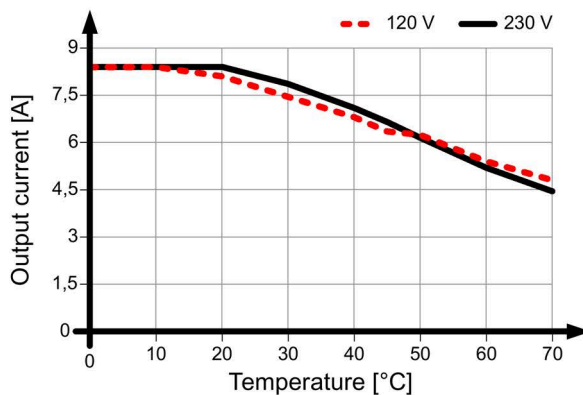

Figure 4-11 Mounting position 2

4.2 Other mounting positions

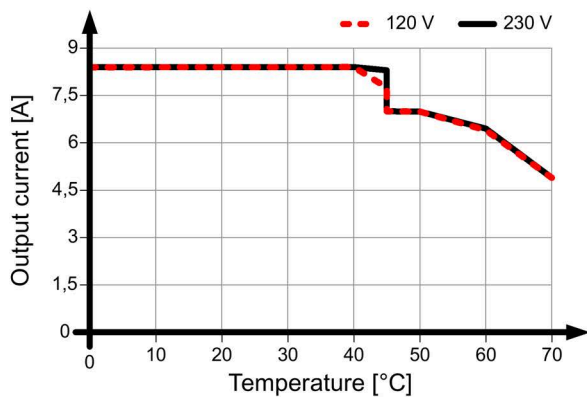

Figure 4-12 Mounting position 3

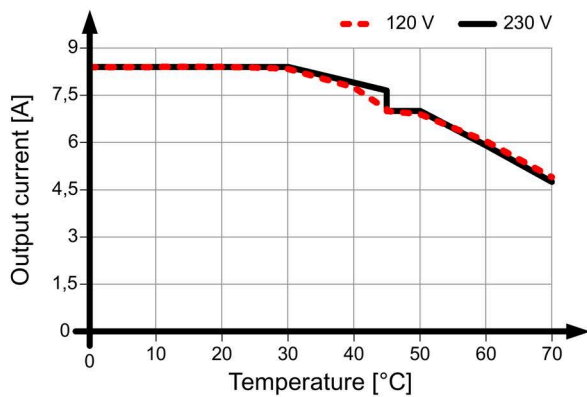

Figure 4-13 Mounting position 4

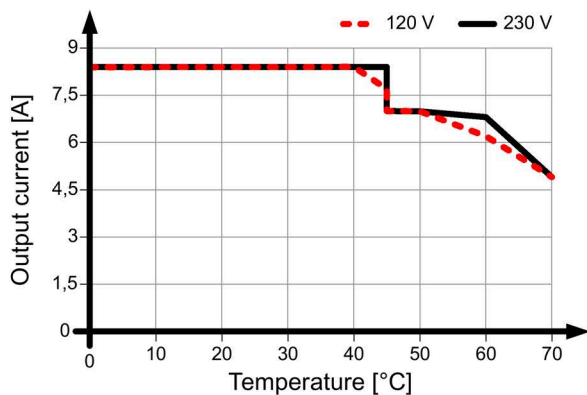

Figure 4-14 Mounting position 5

4.2.2 6EP3324-7SB00-3AX0

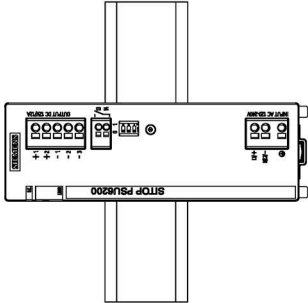
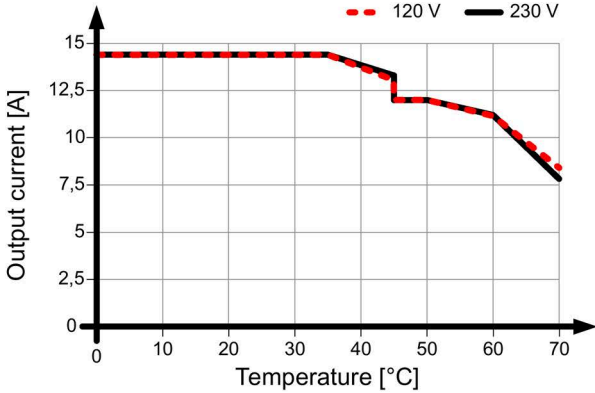

Figure 4-15 Mounting position 1

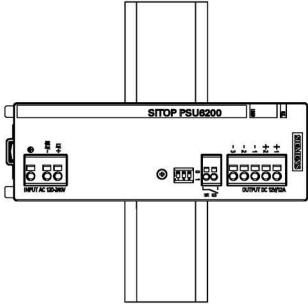
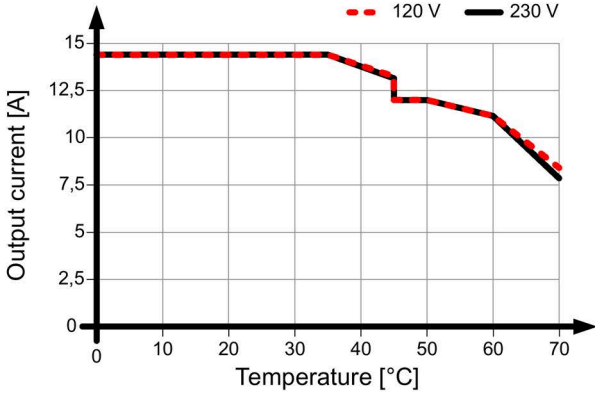

Figure 4-16 Mounting position 2

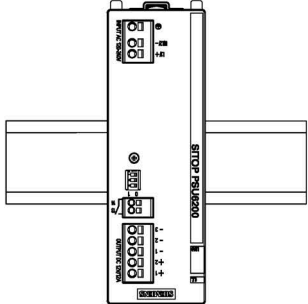
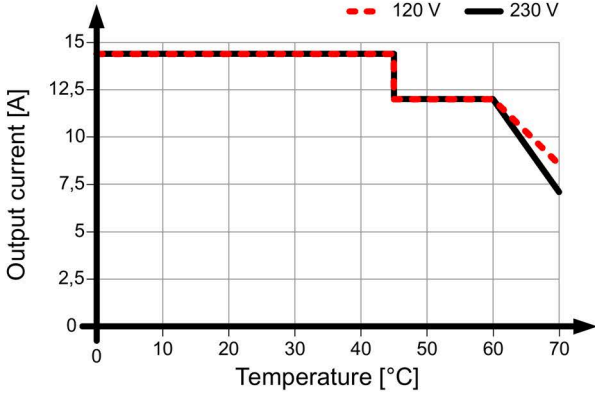

Figure 4-17 Mounting position 3

4.2 Other mounting positions

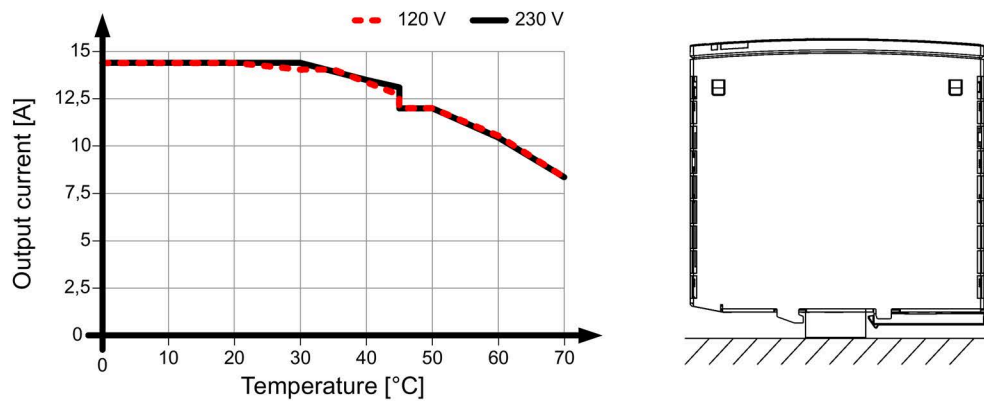

Figure 4-18 Mounting position 4

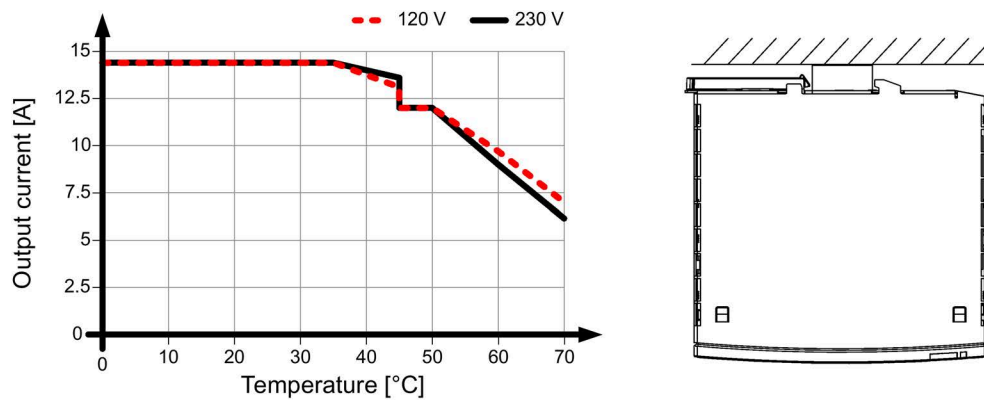

Figure 4-19 Mounting position 5

4.2.3 6EP3333-7LB00-0AX0

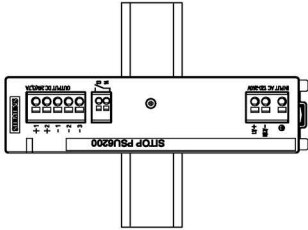
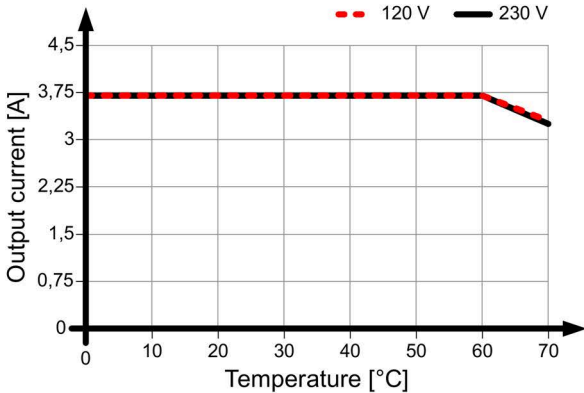

Figure 4-20 Mounting position 1

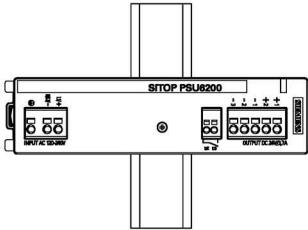
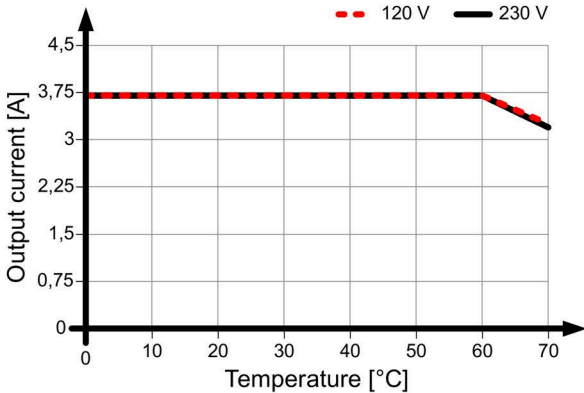

Figure 4-21 Mounting position 2

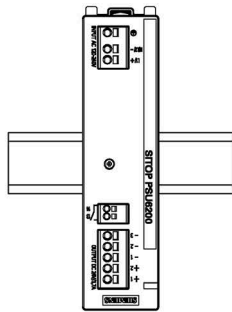
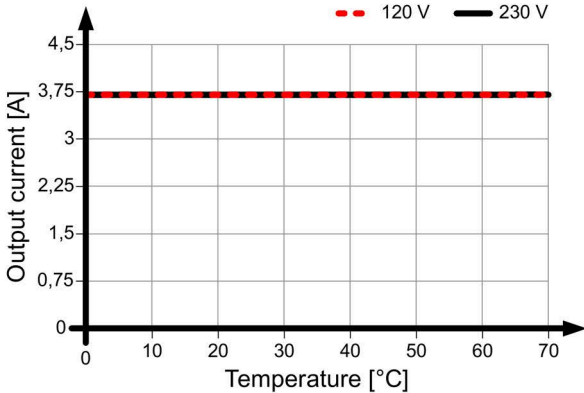

Figure 4-22 Mounting position 3

4.2 Other mounting positions

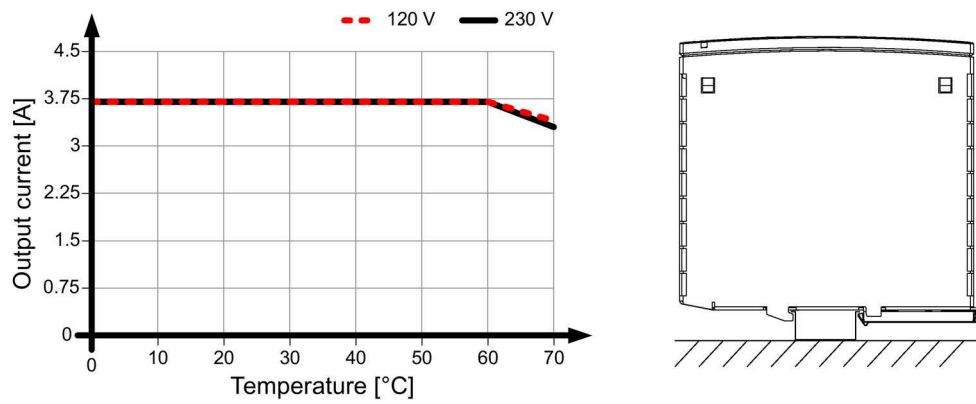

Figure 4-23 Mounting position 4

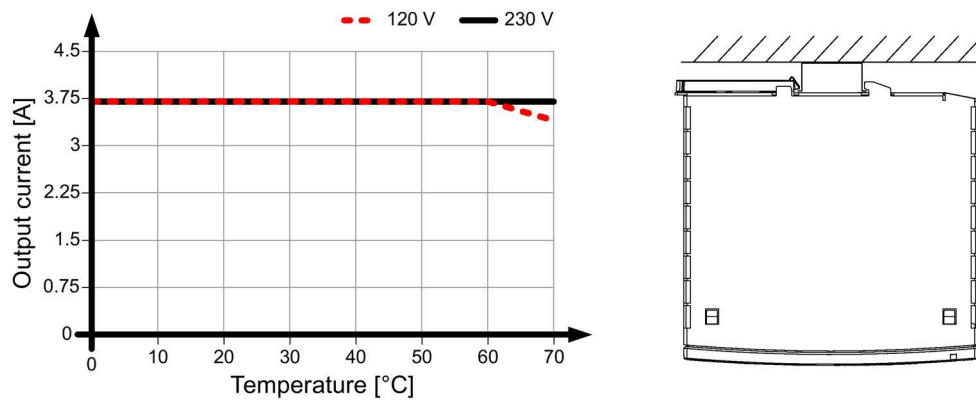

Figure 4-24 Mounting position 5

4.2.4 6EP3333-7SB00-0AX0 and 6EP3333-7SC00-0AX0

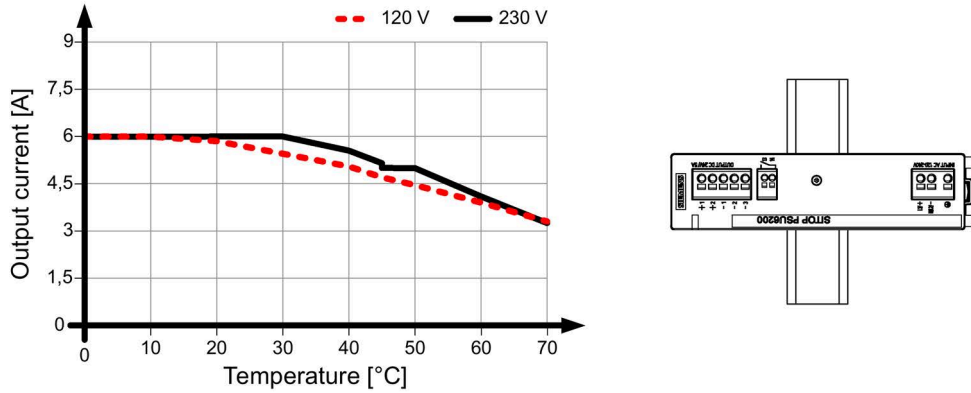

Figure 4-25 Mounting position 1

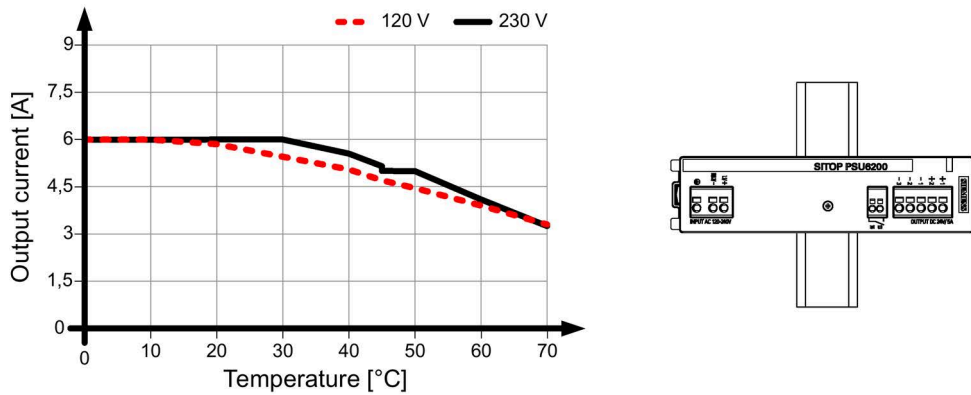

Figure 4-26 Mounting position 2

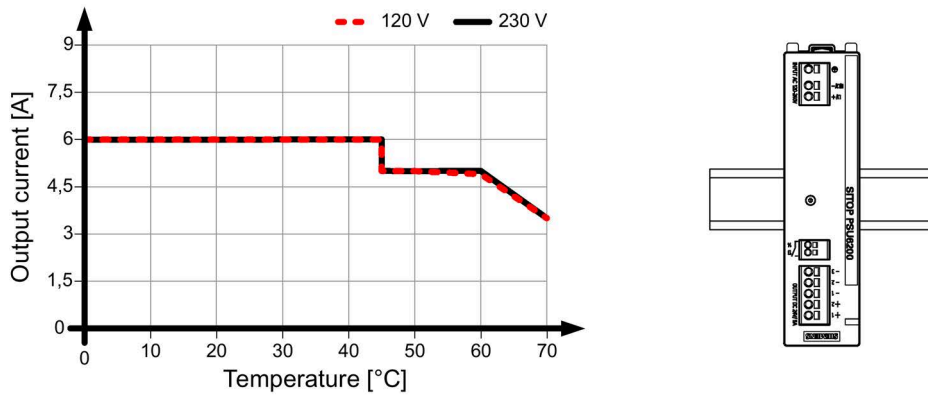

Figure 4-27 Mounting position 3

4.2 Other mounting positions

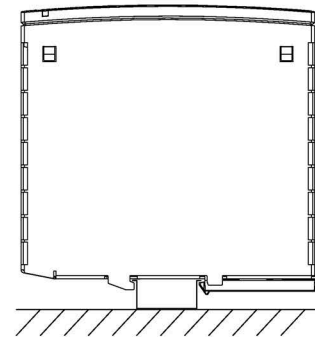
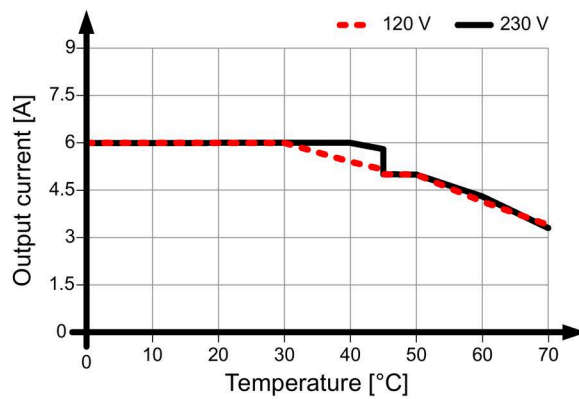

Figure 4-28 Mounting position 4

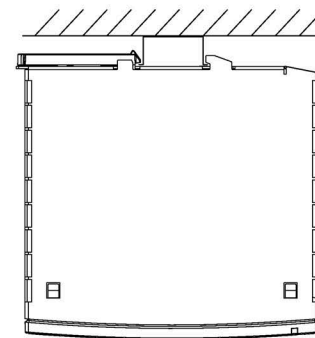
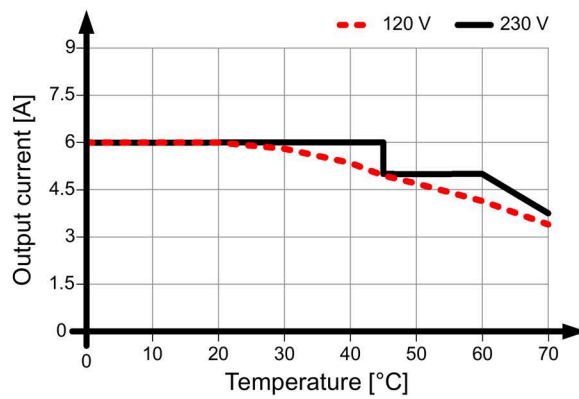

Figure 4-29 Mounting position 5

4.2.5 6EP3334-7SB00-3AX0 and 6EP3334-7SC00-3AX0

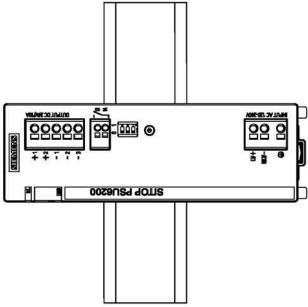
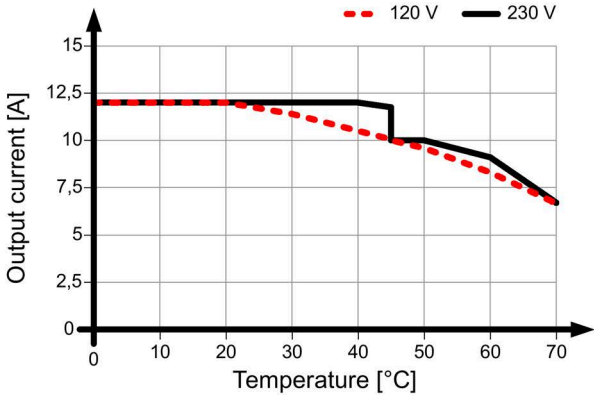

Figure 4-30 Mounting position 1

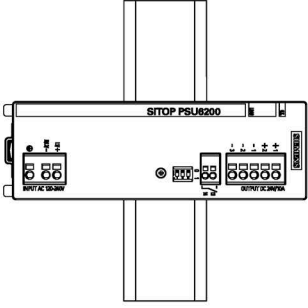
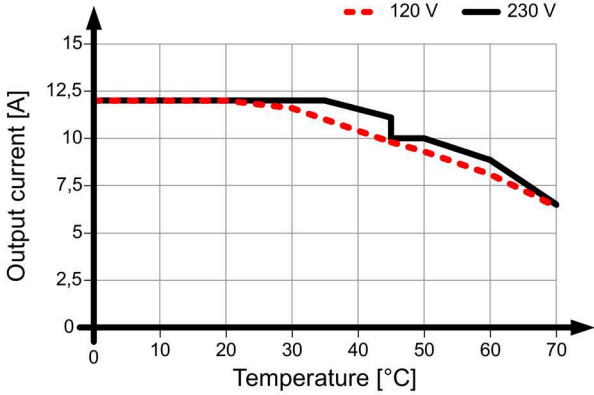

Figure 4-31 Mounting position 2

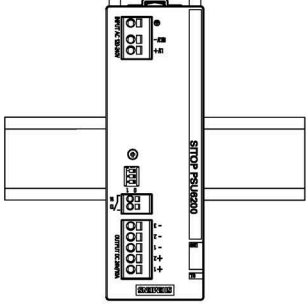
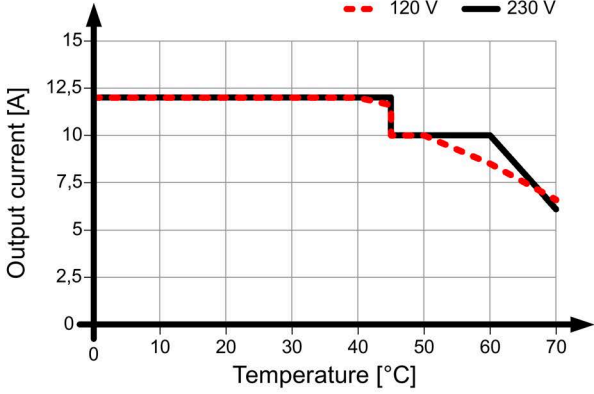

Figure 4-32 Mounting position 3

4.2 Other mounting positions

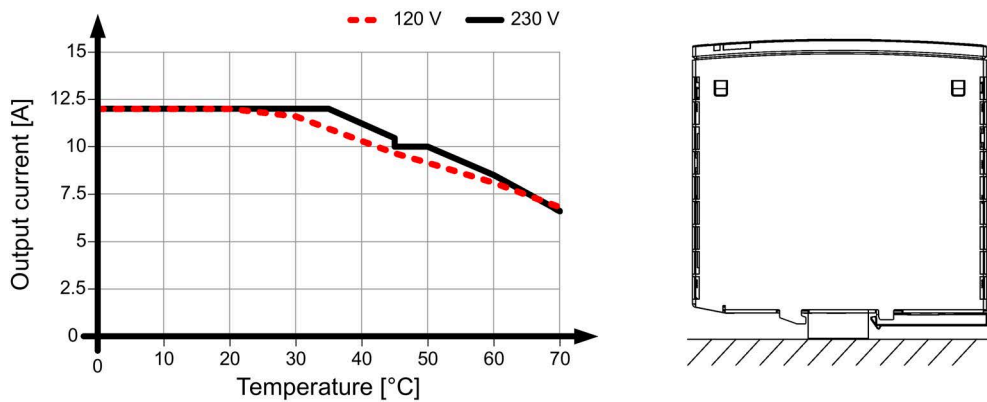

Figure 4-33 Mounting position 4

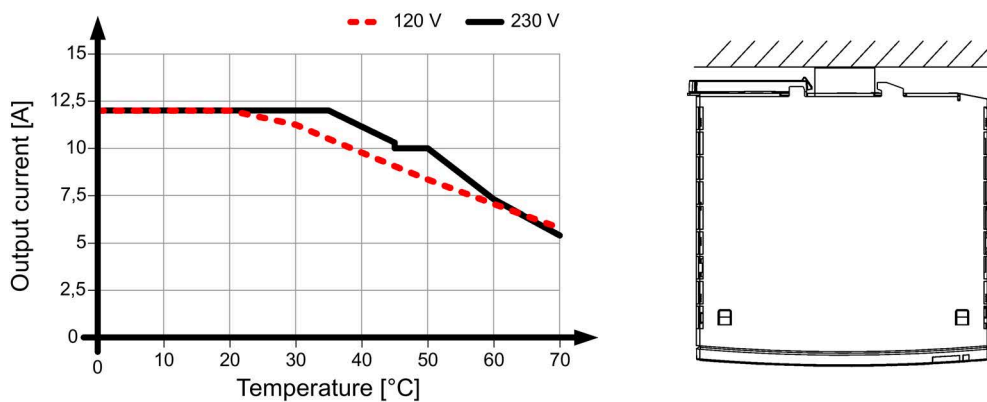

Figure 4-34 Mounting position 5

4.2.6 6EP3336-7SB00-3AX0 and 6EP3336-7SC00-3AX0

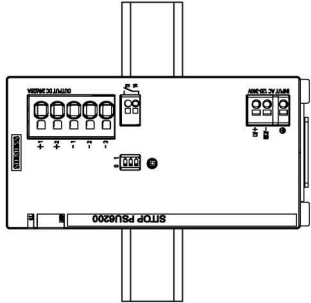
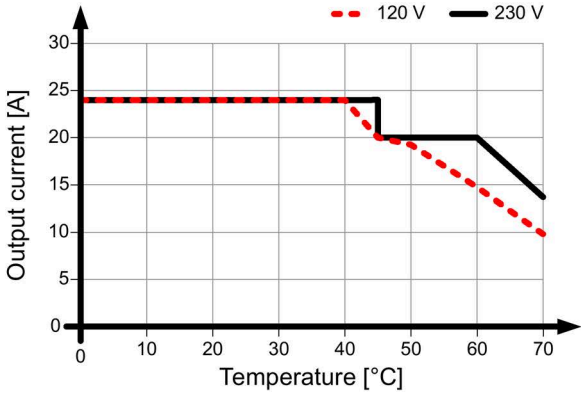

Figure 4-35 Mounting position 1

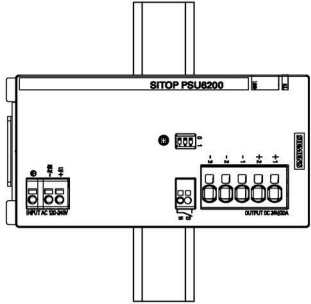
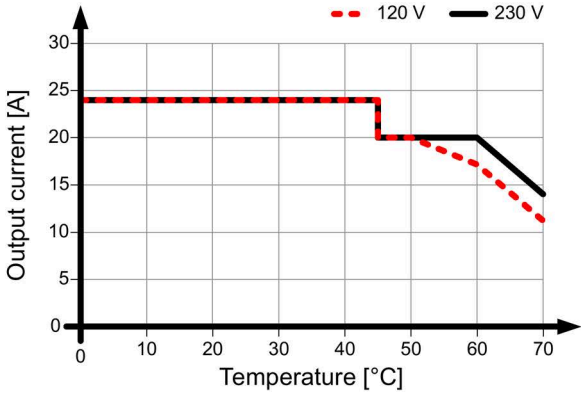

Figure 4-36 Mounting position 2

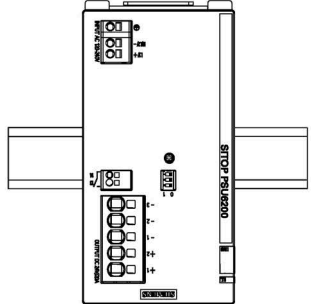
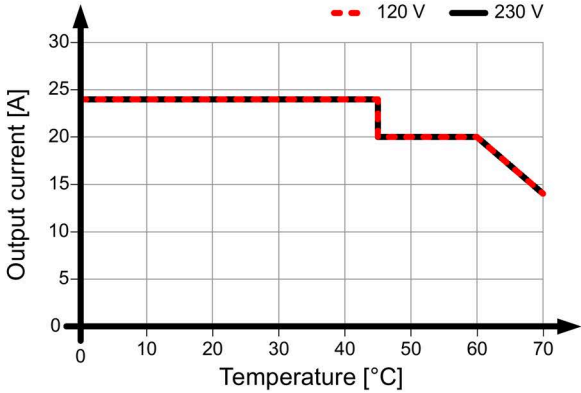

Figure 4-37 Mounting position 3

4.2 Other mounting positions

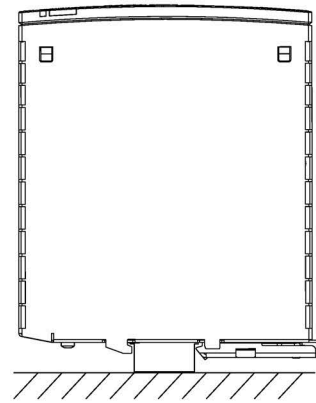
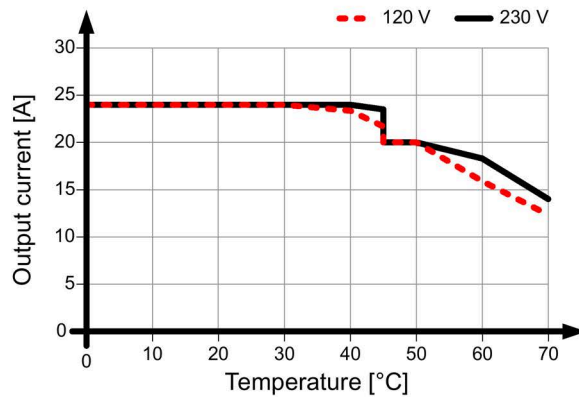

Figure 4-38 Mounting position 4

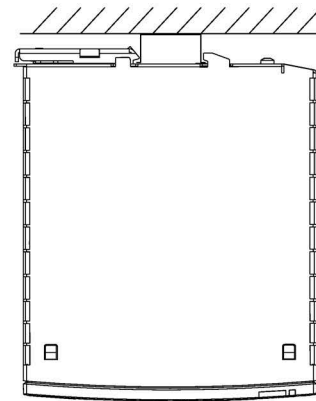
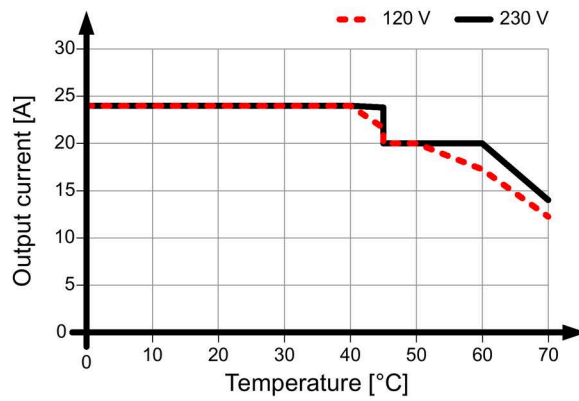

Figure 4-39 Mounting position 5

4.2.7 6EP3344-7SB00-3AX0

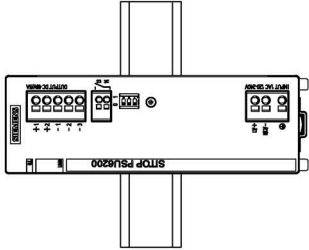
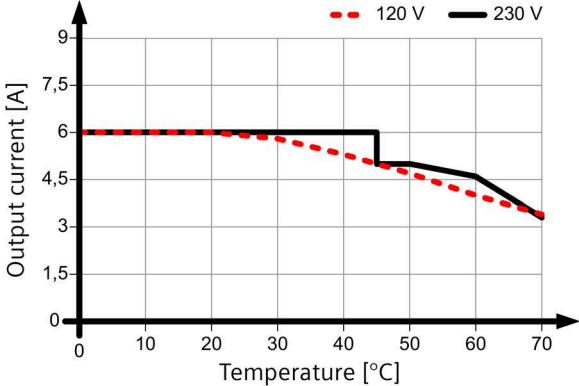

Figure 4-40 Mounting position 1

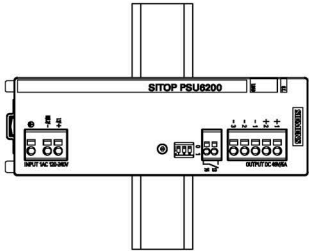
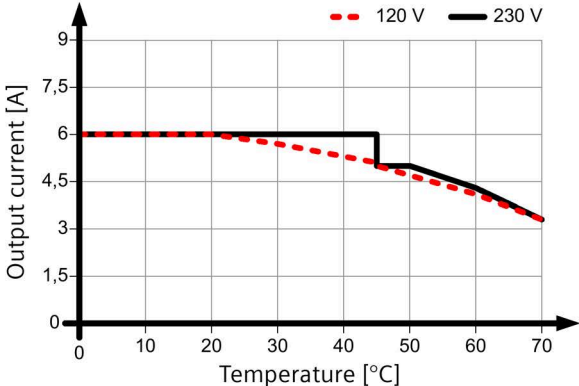

Figure 4-41 Mounting position 2

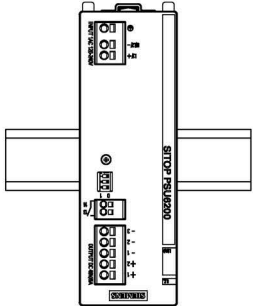
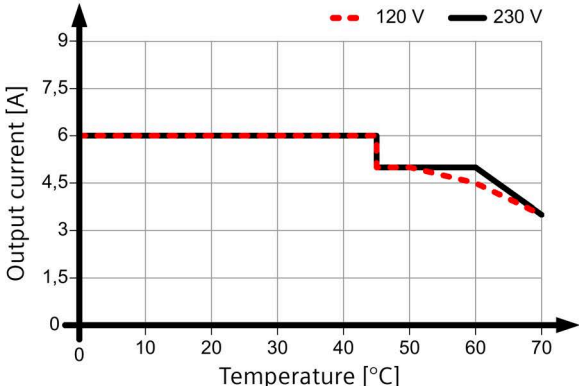

Figure 4-42 Mounting position 3

4.2 Other mounting positions

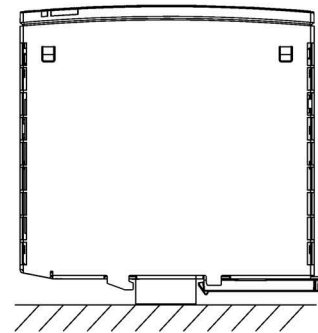
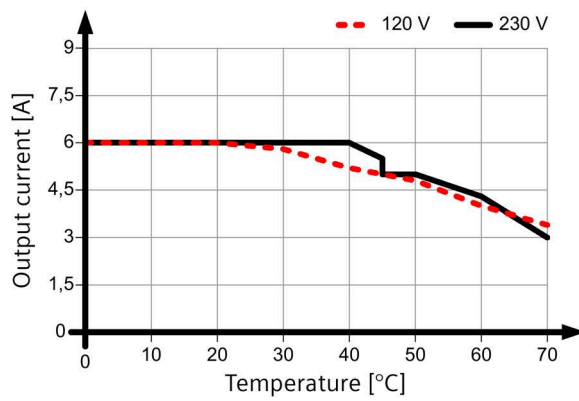

Figure 4-43 Mounting position 4

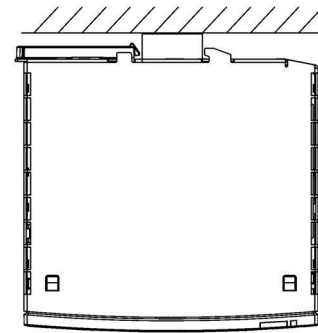
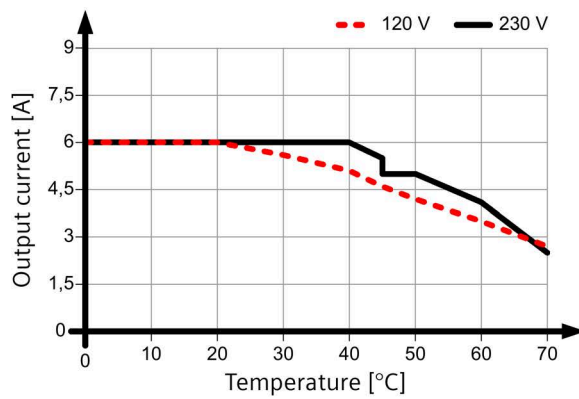

Figure 4-44 Mounting position 5

4.2.8 6EP3346-7SB00-3AX0

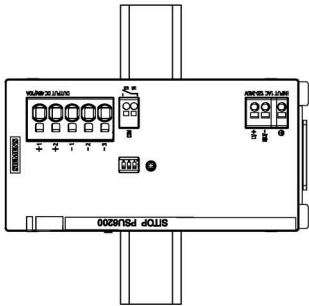
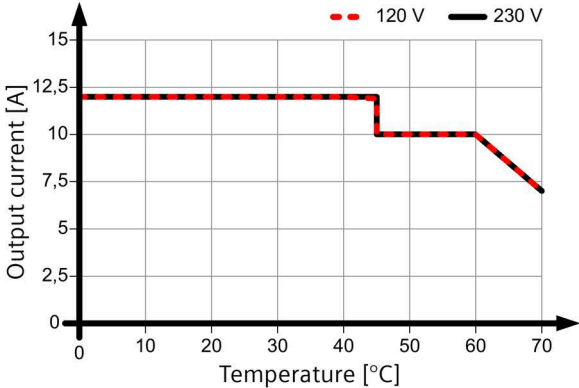

Figure 4-45 Mounting position 1

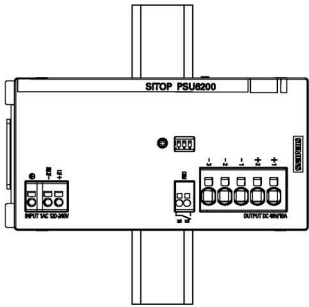
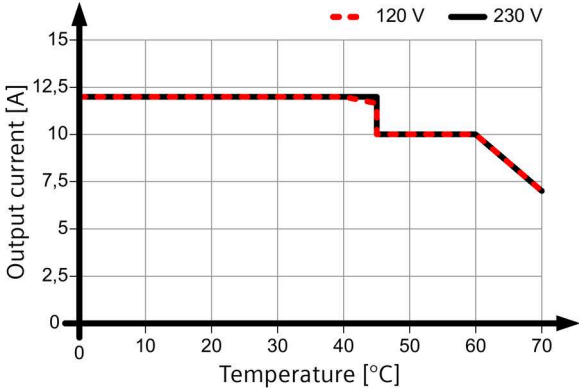

Figure 4-46 Mounting position 2

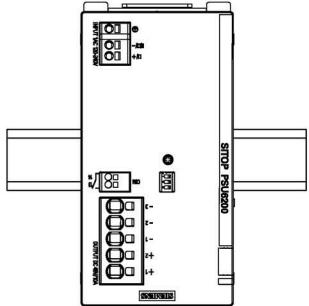
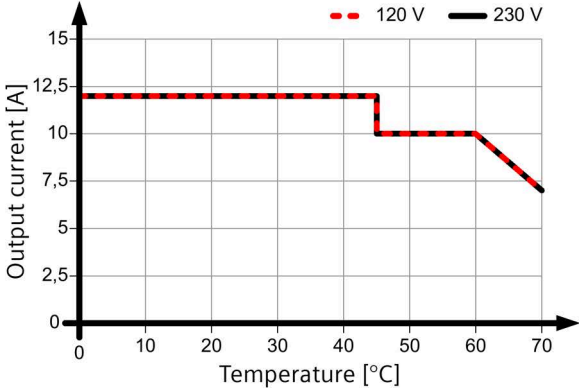

Figure 4-47 Mounting position 3

4.2 Other mounting positions

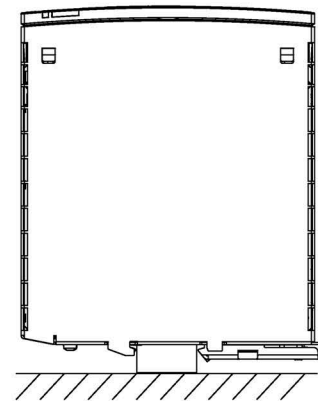
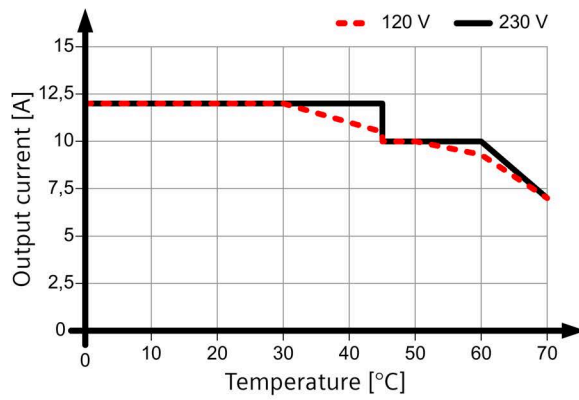

Figure 4-48 Mounting position 4

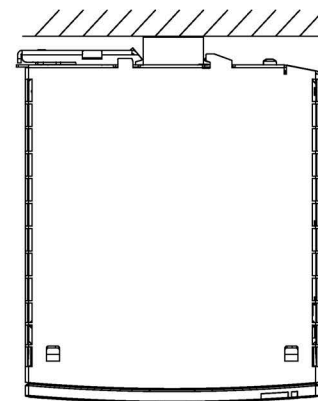
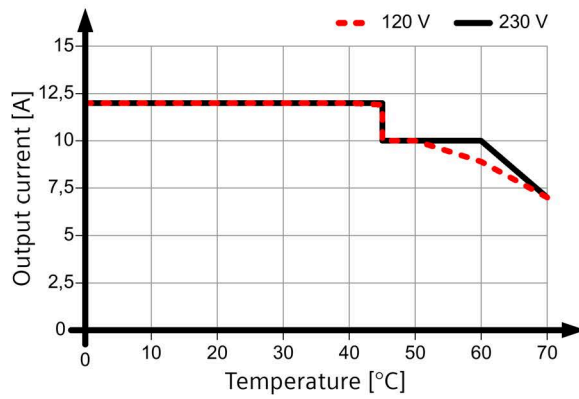

Figure 4-49 Mounting position 5

<p>! WARNING</p> <p>Hazard due to electric shock</p> <p>Before installation or maintenance work can begin, the system's main switch must be switched off and measures taken to prevent it being switched on again. If this instruction is not observed, touching live parts can result in death or serious injury.</p>
--

Use copper wire approved for 80 °C for the wiring.

5.1 Line-side connection

SITOP PSU6200 power supplies are designed for a 1-phase AC line voltage (TN-, TT or IT line supply according to IEC 60364-1 with a line voltage of 120 - 240 V AC, 50 - 60 Hz or a DC supply with 120 - 240 V DC (12 V/7 A, 24 V/3.7 A, 24 V/5 A) or 110 - 240 V DC (12 V/12 A, 24 V/10 A, 48 V/5 A, 48 V/10 A).



Figure 5-1 Line-side connection

The line supply is connected using terminals L1, N (L2), and PE (see Figure 5-1 Line-side connection (Page 43)), and must be implemented according to IEC 60364 and EN 50178. A protective device (miniature circuit breaker or circuit breaker) and a disconnection unit for the power supply must be provided. A ground-fault circuit interrupter is not permissible against indirect contact as the only protective measure. This is true for the complete line supply protected by the ground-fault circuit interrupter.

Protection

SITOP PSU6200	Recommended line-side protection
6EP3323-7SB00-0AX0 (12 V/7 A) 6EP3324-7SB00-3AX0 (12 V/12 A) 6EP3333-7LB00-0AX0 (24 V/3.7 A) 6EP3333-7SB00-0AX0 6EP3333-7SC00-0AX0 (24 V/5 A)	Miniature circuit breaker (IEC 898) characteristic C, 6 A
6EP3334-7SB00-3AX0 6EP3334-7SC00-3AX0 (24 V/10 A) 6EP3336-7SB00-3AX0 6EP3336-7SC00-3AX0 (24 V/20 A) 6EP3344-7SB00-3AX0 (48 V/5 A) 6EP3346-7SB00-3AX0 (48 V/10 A)	Miniature circuit breaker (IEC 898) characteristic C, 10 A

The protective conductor of the line supply must be connected at the PE terminal.

Other country-specific regulations may have to be observed when installing the device.

NOTICE

Country-specific regulations must be observed when installing.

Note

For operation on a DC power system (DC), the plus pole (+) must be connected to L1 and the minus pole (–) to N.

5.2 Output-side connection

SITOP PSU6200 power supplies provide an isolated (= ungrounded) SELV (ES1) output voltage (Safety Extra Low Voltage (Electrical energy source class 1)). The output of the power supply is no-load, overload, and short-circuit proof. If an overload occurs, the electronic current limitation limits the output current to a maximum value (refer to chapter Technical data (Page 47)).

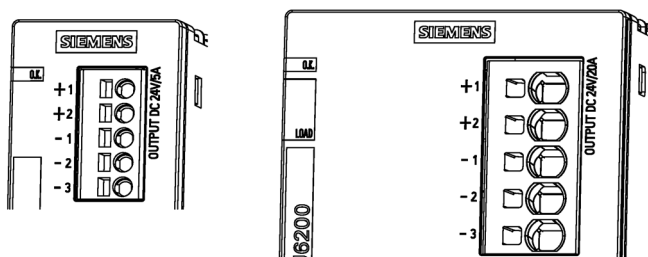

Figure 5-2 Output-side connection

The output voltage is connected via the "+" and "-" terminals at the output of the power supply (see Figure Output-side connection (Page 45)). Ensure that the output cables are dimensioned correctly for the maximum output current rms value and fused accordingly.

The subsequent digit, e.g.: "+1" designates the unique terminal connection, therefore simplifying correct wiring.

Note

If the safety concept of the plant or system specifies that the DC output circuit should be grounded (PELV), then it is permissible that the output voltage of the SITOP power supply is grounded. In this case, ideally, the grounding at the output should be directly connected from terminal "-" of the power supply to a suitable connection point of the protective conductor system (PE) of the plant or system.

Technical data

Note

Technical data apply for a rated input voltage, rated load and 25 °C ambient temperature if nothing else is specified.

6.1 Input

	6EP3323-7SB00-0AX0 (12 V/7 A)	6EP3324-7SB00-3AX0 (12 V/12 A)
Rated voltage $U_{in \text{ rated}}$	AC: 120 - 240 V; DC: 120 - 240 V	AC: 120 - 240 V; DC: 110 - 240 V
Voltage range	AC: 102 - 264 V; DC: 99 - 275 V	AC: 102 - 264 V; DC: 85 - 275 V
• Remark	Derating at $U_{in} < 110 \text{ V DC}$: max. 80 % $I_{out \text{ rated}}$	-
Wide-range input	Yes	
Switch-in/switch-out threshold, typical	81 V / 49 V	83 V / 58 V
Power failure buffering at $I_{out \text{ rated}}$, min	20 ms	20 ms
Power-failure buffering	at 120 V / 240 V	
Rated line frequency	50 - 60 Hz	
Line frequency range	47 - 63 Hz	
Input current at the rated input voltage of 120 V	1.5 A AC / 0.9 A DC	1.3 A AC / 1.4 A DC
Input current at a rated input voltage of 240 V	0.8 A AC / 0.5 A DC	0.8 A AC / 0.7 A DC
Inrush current limiting (25 °C), max.	29 A	6 A
I^2t , at 120 V AC, max.	0.4 A ² s	1 A ² s
I^2t , at 240 V AC, max.	1.3 A ² s	0.5 A ² s
Integrated input fuse	Fuse T 3.15 A	T 6 A fuse
Protection/fusing in the line feeder cable (IEC 898)	Recommended: Miniature circuit breaker characteristic C, 6 A	Recommended: Miniature circuit breaker characteristic C, 6 A
Power consumption (active power) at full load	98 W	158 W
Overtoltage strength	300 V AC for 30 seconds	

Technical data

6.1 Input

	6EP3333-7LB00-0AX0 (24 V/3.7 A)	6EP3333-7SB00-0AX0 6EP3333-7SC00-0AX0 (24 V/5 A)	6EP3334-7SB00-3AX0 6EP3334-7SC00-3AX0 (24 V/10 A)	6EP3336-7SB00-3AX0 6EP3336-7SC00-3AX0 (24 V/20 A)
Rated voltage $U_{in \text{ rated}}$	AC: 120 - 240 V; DC: 120 - 240 V		AC: 120 - 240 V; DC: 110 - 240 V	
Voltage range	AC: 102 - 264 V; DC: 99 - 275 V	AC: 102 - 264 V; DC: 99 - 275 V	AC: 102 - 264 V; DC: 85 - 275 V	AC: 102 - 264 V; DC: 85 - 275 V
• Remark	-	Derating at U_{in} < 110 V DC: max. 80 % $I_{out \text{ rated}}$	Derating at U_{in} < 110 V DC: max. 80 % $I_{out \text{ rated}}$	Derating at U_{in} < 110 V DC: max. 90 % $I_{out \text{ rated}}$
Wide-range input	Yes			
Switch-in/switch-out threshold, typical	82 V / 51 V	83 V / 53 V	83 V / 74 V	83 V / 74 V
Line failure buffering at $I_{out \text{ rated}}$, min	20 ms	20 ms	20 ms	20 ms
Power-failure buffering	at 120 V / 240 V			
Rated line frequency	50 - 60 Hz			
Line frequency range	47 - 63 Hz			
Input current at rated input voltage 120 V	1.5 A AC / 0.9 A DC	1.9 A AC / 1.1 A DC	2.2 A AC / 2.2 A DC	4.4 A AC / 4.8 A DC
Input current at a rated input voltage of 240 V	0.8 A AC / 0.5 A DC	1.1 A AC / 0.6 A DC	1.2 A AC / 1.1 A DC	2.2 A AC / 2.2 A DC
Inrush current limiting (25 °C), max.	29 A	30 A	6 A	12 A
I^2t , at 120 V AC, max.	0.4 A ² s	0.4 A ² s	1 A ² s	4 A ² s
I^2t , at 240 V AC, max.	1.3 A ² s	1.3 A ² s	0.6 A ² s	1.4 A ² s
Integrated input fuse	Fuse T 3.15 A	Fuse T 3.15 A	T 6 A fuse	T 10 A fuse
Protection/fusing in the line feeder cable (IEC 898)	Recommended: Miniature circuit breaker characteristic C, 6 A	Recommended: Miniature circuit breaker characteristic C, 6 A	Recommended: Miniature circuit breaker characteristic C, 10 A	Recommended: Miniature circuit breaker characteristic C, 10 A
Power consumption (active power) at full load	100 W	133 W	260 W	500 W
Overvoltage strength	300 V AC for 30 seconds			

	6EP3344-7SB00-3AX0 (48 V/5 A)	6EP3346-7SB00-3AX0 (48 V/10 A)
Rated voltage $U_{in \text{ rated}}$	AC: 120 - 240 V; DC: 110 - 240 V	
Voltage range	AC: 102 - 264 V; DC: 85 - 275 V	
• Remark	Derating at $U_{in} < 110 \text{ V DC}$: max. 80 % $I_{out \text{ rated}}$	
Wide-range input	Yes	
Switch-in/switch-out threshold, typical	83 V / 74 V	
Power failure buffering at $I_{out \text{ rated}}$, min	20 ms	
Power-failure buffering	at 120 V / 240 V	
Rated line frequency	50 - 60 Hz	
Line frequency range	47 - 63 Hz	
Input current at the rated input voltage of 120 V	2.2 A AC / 2.5 A DC	4.4 A AC / 5 A DC
Input current at a rated input voltage of 240 V	1.2 A AC / 1.2 A DC	2.2 A AC / 2.2 A DC
Inrush current limiting (25 °C), max.	6 A	12 A
I^2t , at 120 V AC, max.	1 A ² s	4 A ² s
I^2t , at 240 V AC, max.	0.6 A ² s	1.4 A ² s
Integrated input fuse	T 6 A fuse	T 10 A fuse
Protection/fusing in the line feeder cable (IEC 898)	Recommended: Miniature circuit breaker characteristic C, 10 A	
Power consumption (active power) at full load	255 W	502 W
Overvoltage strength	300 V AC for 30 seconds	

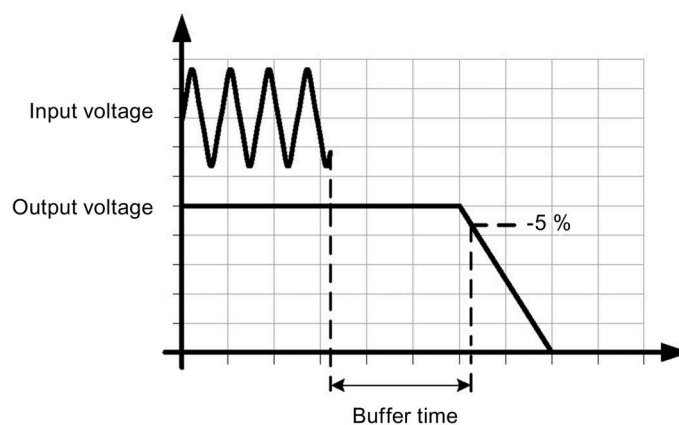

Figure 6-1 Power failure buffering

6.2 Output

	6EP3323-7SB00-0AX0 (12 V/7 A)	6EP3324-7SB00-3AX0 (12 V/12 A)
Output	Regulated, isolated DC voltage	
Rated voltage $U_{out\ rated\ DC}$	12 V	
Total tolerance, static \pm	3 %	3 %
Static line regulation, approx. \pm	0.1 %	0.1 %
Static load regulation, approx. \pm	1 %	1 %
Residual ripple Peak-peak, max.	150 mV	150 mV
Spikes peak-peak, max. (bandwidth, 200 MHz)	240 mV	240 mV
Adjustment range	12 - 15.5 V	
Output voltage can be adjusted	Yes	
Output voltage setting	Using a potentiometer	
Status display	LED green for 12 V O.K.	LED green for 12 V O.K., diagnostics monitor, see Chapter Status displays and signaling (Page 13)
Signaling	Relay contact (NO contact, contact rating 60 V DC/0.3 A) for 12 V O.K.	
Response when switching on/off	Overshoot of $U_{out} < 100\text{ mV}$	
Starting delay, max.	90 ms	310 ms
Starting delay, typ.	30 ms	140 ms
Voltage rise 120 V / 240 V AC max.	50 ms	100 ms
Voltage rise 120 V / 240 V AC typ.	30 ms	80 ms
Rated current $I_{out\ rated}$	7 A	12 A
Current range	0 - 7 A	0 - 12 A
• Remark	8.4 A to 45 °C 60 ... 70 °C derating: 3 % $I_{out\ rated}/K$	14.4 A to 45 °C 60 ... 70 °C derating: 3 % $I_{out\ rated}/K$
Active power output, typ.	84 W	144 W
Overload capability (Extra Power)	10.5 A for 5 s/min	18 A for 5 s/min
Can be connected in parallel to increase the power rating	No	Yes
Number of devices that can be connected in parallel to increase the power rating, units	-	2
Output characteristic	see Figure 6-3 Output characteristic 6EP3323-7SB00-0AX0 single operation (Page 53)	see Figure 6-4 Output characteristic 6EP3324-7SB00-3AX0 single operation (Page 54)
Capacitive load, max.	2 mF/A	

	6EP3333-7LB00-0AX0 (24 V/3.7 A)	6EP3333-7SB00-0AX0 6EP3333-7SC00-0AX0 (24 V/5 A)	6EP3334-7SB00-3AX0 6EP3334-7SC00-3AX0 (24 V/10 A)	6EP3336-7SB00-3AX0 6EP3336-7SC00-3AX0 (24 V/20 A)
Output	Regulated, isolated DC voltage			
Rated voltage $U_{out\ rated\ DC}$	24 V			
Total tolerance, static \pm	3 %	3 %	3 %	3 %
Static line regulation, approx. \pm	0.1 %	0.1 %	0.1 %	0.5 %
Static load regulation, approx. \pm	1 %	1 %	1 %	1 %
Residual ripple Peak-peak, max.	150 mV	150 mV	150 mV	150 mV
Spikes peak-peak, max. (bandwidth, 200 MHz)	240 mV	240 mV	240 mV	240 mV
Adjustment range	24 V - 28 V			
Output voltage can be adjusted	Yes			
Output voltage setting	Using a potentiometer			
Status display	LED green for 24 V O.K.		LED green for 24 V O.K., diagnostics monitor, see Chapter Status displays and signaling (Page 13)	LED green for 24 V O.K., diagnostics monitor, see Chapter Status displays and signaling (Page 13)
Signaling	Relay contact (NO contact, contact rating 60 V DC/0.3 A) for 24 V O.K.			
Response when switching on/off	Overshoot of $U_{out} < 100\text{ mV}$			Overshoot of $U_{out} < 520\text{ mV}$
Starting delay, max.	90 ms	90 ms	310 ms	230 ms
Starting delay, typ.	30 ms	30 ms	140 ms	80 ms
Voltage rise 120 V / 240 V AC max.	150 ms	100 ms	200 ms	100 ms
Voltage rise 120 V / 240 V AC typ.	130 ms	50 ms	180 ms	80 ms
Rated current $I_{out\ rated}$	3.7 A	5 A	10 A	20 A
Current range	0 - 3.7 A	0 - 5 A	0 - 10 A	0 - 20 A
• Remark		6 A to 45 °C 60 ... 70 °C derating: 3 % $I_{out\ rated}/K$	12 A to 45 °C 60 ... 70 °C derating: 3 % $I_{out\ rated}/K$	24 A to 45 °C 60 ... 70 °C derating: 3 % $I_{out\ rated}/K$
Active power output, typ.	89 W	120 W	240 W	480 W
Overload capability (Extra Power)	-	7.5 A for 5 s/min	15 A for 5 s/min	30 A for 5 s/min
Can be connected in parallel to increase the power rating	No	No	Yes	Yes
Number of devices that can be connected in parallel to increase the power rating, units	-	-	2	2

Technical data

6.2 Output

	6EP3323-7SB00-0AX0 (12 V/7 A)	6EP3324-7SB00-3AX0 (12 V/12 A)
Output characteristic	see Figure 6-5 Output characteristic 6EP3333-7LB00-0AX0 single operation (Page 54)	see Figure 6-6 Output characteristic 6EP3333-7SB00-0AX0 and 6EP3333-7SC00-0AX0 single operation (Page 54)
Capacitive load, max.	2 mF/A	see Figure 6-7 Output characteristic 6EP3334-7SB00-3AX0 and 6EP3334-7SC00-3AX0 single operation (Page 55)
		see Figure 6-8 Output characteristic 6EP3336-7SB00-3AX0 and 6EP3336-7SC00-3AX0 single operation (Page 55)
	6EP3344-7SB00-3AX0 (48 V/5 A)	6EP3346-7SB00-3AX0 (48 V/10 A)
Output	Regulated, isolated DC voltage	
Rated voltage $U_{out\ rated\ DC}$	48 V	
Total tolerance, static \pm	3 %	3 %
Static line regulation, approx. \pm	0.1 %	0.5 %
Static load regulation, approx. \pm	1 %	1 %
Residual ripple Peak-peak, max.	150 mV	
Spikes peak-peak, max. (bandwidth, 200 MHz)	240 mV	
Adjustment range	48 - 56 V	
Output voltage can be adjusted	Yes	
Output voltage setting	Using a potentiometer	
Status display	LED green for 48 V O.K., diagnostics monitor, see Chapter Status displays and signaling (Page 13)	LED green for 48 V O.K., diagnostics monitor, see Chapter Status displays and signaling (Page 13)
Signaling	Relay contact (NO contact, contact rating 60 V DC/0.3 A) for 48 V O.K.	
Response when switching on/off	Overshoot of $U_{out} < 100\text{ mV}$	
Starting delay, max.	310 ms	230 ms
Starting delay, typ.	140 ms	80 ms
Voltage rise 120 V / 240 V AC max.	200 ms	100 ms
Voltage rise 120 V / 240 V AC typ.	180 ms	80 ms
Rated current $I_{out\ rated}$	5 A	10 A
Current range	0 ... 10 A	0 ... 20 A
• Remark	12 A to 45 °C 60 ... 70 °C derating: 3 % $I_{out\ rated}/K$	24 A to 45 °C 60 ... 70 °C derating: 3 % $I_{out\ rated}/K$
Active power output, typ.	240 W	480 W
Overload capability (Extra Power)	15 A for 5 s/min	30 A for 5 s/min
Can be connected in parallel to increase the power rating	Yes	Yes

	6EP3344-7SB00-3AX0 (48 V/5 A)	6EP3346-7SB00-3AX0 (48 V/10 A)
Number of devices that can be connected in parallel to increase the power rating, units	2	2
Output characteristic	see Figure 6-9 Output characteristic 6EP3344-7SB00-3AX0 single operation (Page 55)	see Figure 6-10 Output characteristic 6EP3346-7SB00-3AX0 single operation (Page 56)
Capacitive load, max.	2 mF/A	

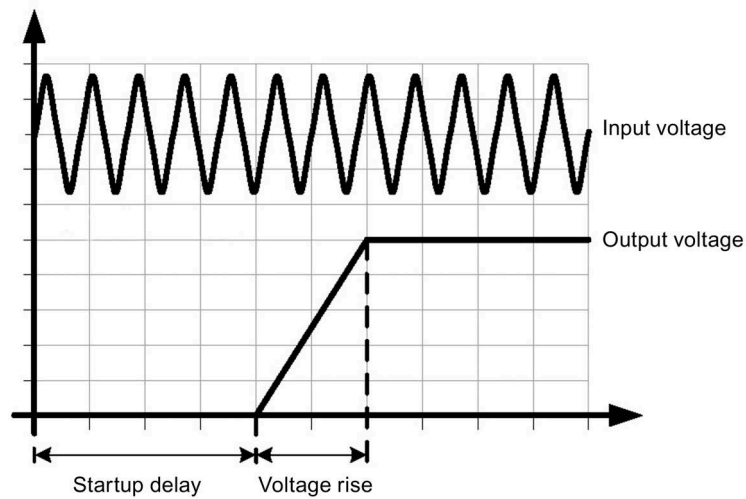

Figure 6-2 Startup delay/voltage rise

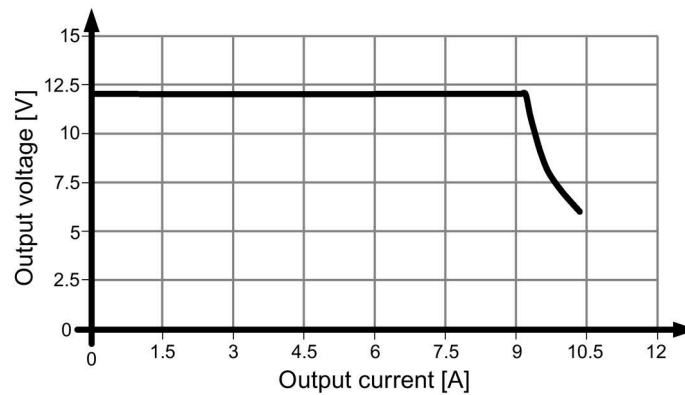

Figure 6-3 Output characteristic 6EP3323-7SB00-0AX0 single operation

6.2 Output

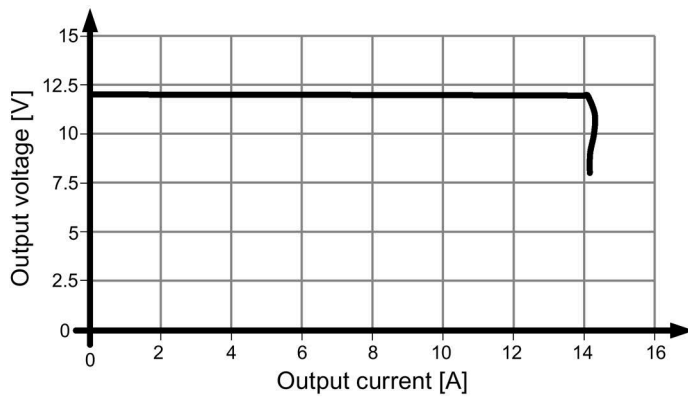

Figure 6-4 Output characteristic 6EP3324-7SB00-3AX0 single operation

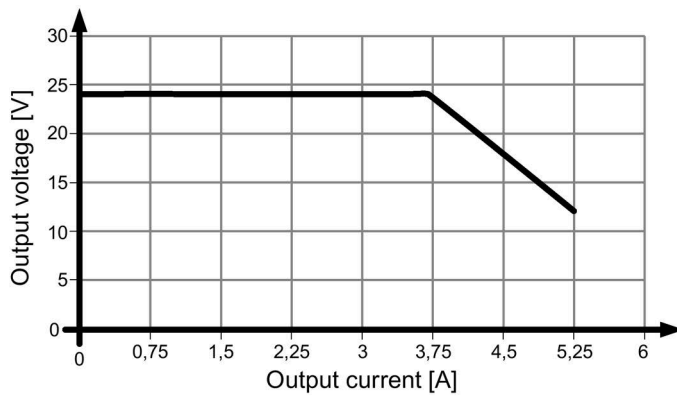

Figure 6-5 Output characteristic 6EP3333-7LB00-0AX0 single operation

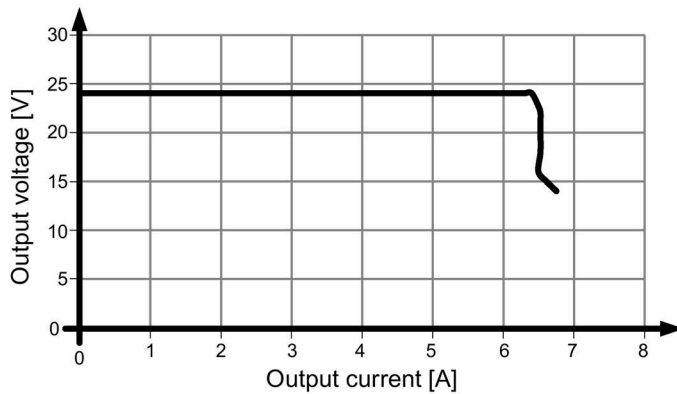

Figure 6-6 Output characteristic 6EP3333-7SB00-0AX0 and 6EP3333-7SC00-0AX0 single operation

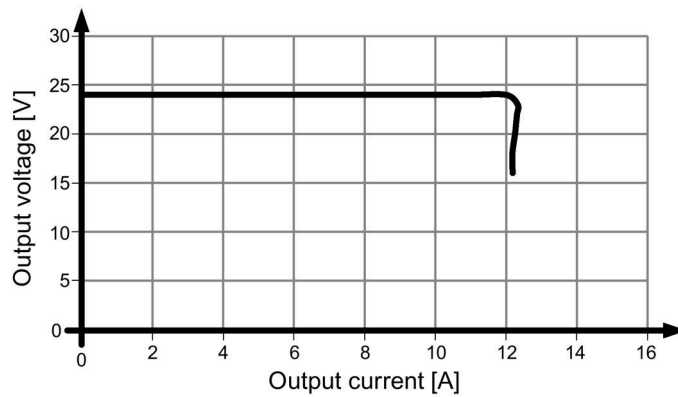

Figure 6-7 Output characteristic 6EP3334-7SB00-3AX0 and 6EP3334-7SC00-3AX0 single operation

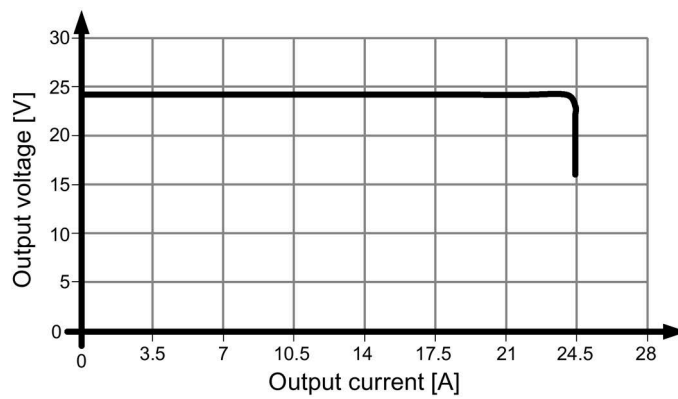

Figure 6-8 Output characteristic 6EP3336-7SB00-3AX0 and 6EP3336-7SC00-3AX0 single operation

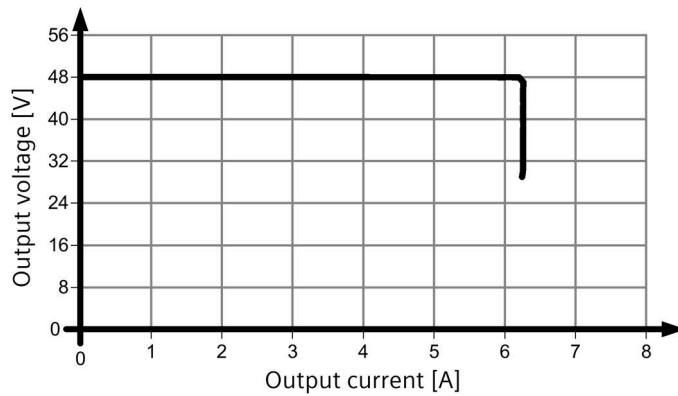

Figure 6-9 Output characteristic 6EP3344-7SB00-3AX0 single operation

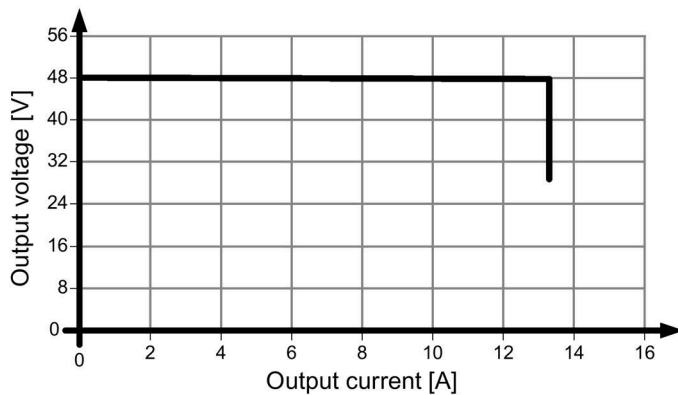

Figure 6-10 Output characteristic 6EP3346-7SB00-3AX0 single operation

The devices supply a constant output voltage until the current limit is reached. In the event of an overload, the output current and the output voltage are reduced.

When the output voltage falls below approx. 60 % of the rated output voltage, the devices switch off and then automatically restart. This response is repeated as long as the overload condition is present.

Selector switch A on (parallel operation):

The output voltage falls with increasing output current.

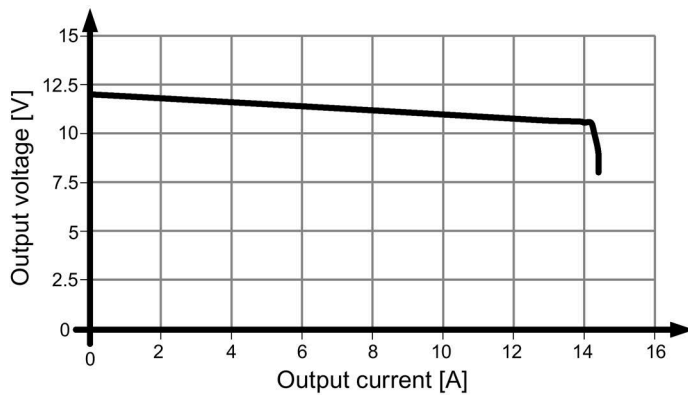

Figure 6-11 Output characteristic 6EP3324-7SB00-3AX0 parallel operation

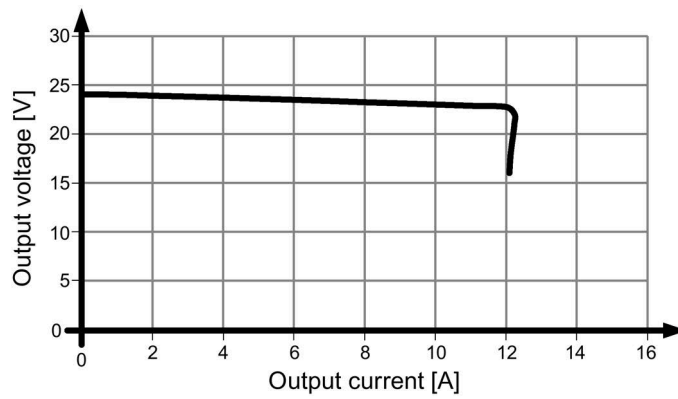

Figure 6-12 Output characteristic 6EP3334-7SB00-3AX0 and 6EP3334-7SC00-3AX0 parallel operation

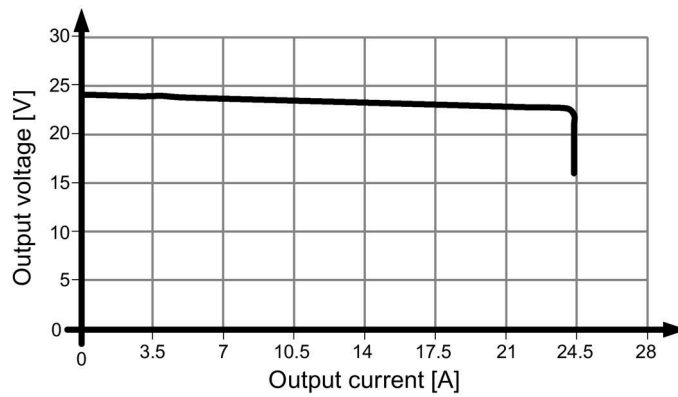

Figure 6-13 Output characteristic 6EP3336-7SB00-3AX0 and 6EP3336-7SC00-3AX0 parallel operation

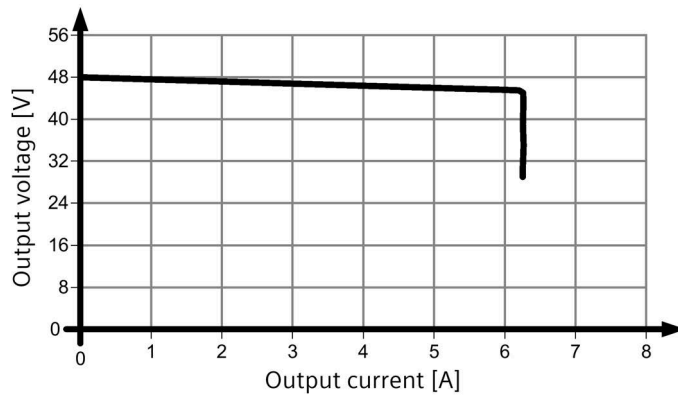

Figure 6-14 Output characteristic 6EP3344-7SB00-3AX0 parallel operation

6.2 Output

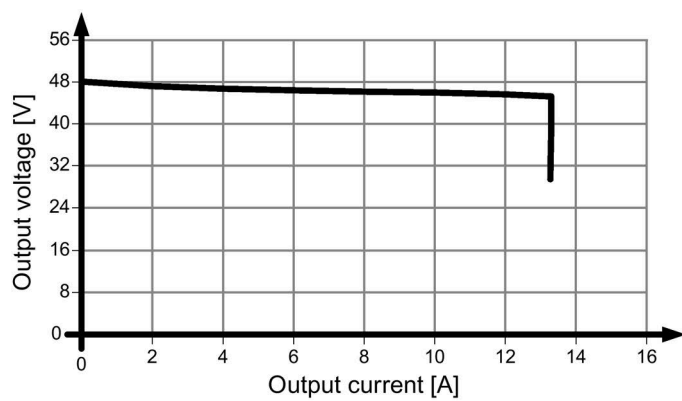

Figure 6-15 Output characteristic 6EP3346-7SB00-3AX0 parallel operation

6.3 Efficiency

	6EP3323-7SB00-0AX0 (12 V/7 A)	6EP3324-7SB00-3AX0 (12 V/12 A)		
Efficiency at $U_{out\ rated}$, $I_{out\ rated}$ 120 V / 240 V AC approx.	86.2 % / 87.1 %	89.4 % / 89.9 %		
Power loss at $U_{out\ rated}$, $I_{out\ rated}$ 120 V / 240 V AC approx.	14 W / 13 W	17 W / 17 W		
Power loss when idling 120 V / 240 V AC approx.	1.2 W / 1.7 W	3.1 W / 2.6 W		

	6EP3333-7LB00-0AX0 (24 V/3.7 A)	6EP3333-7SB00-0AX0 6EP3333-7SC00-0AX0 (24 V/5 A)	6EP3334-7SB00-3AX0 6EP3334-7SC00-3AX0 (24 V/10 A)	6EP3336-7SB00-3AX0 6EP3336-7SC00-3AX0 (24 V/20 A)
Efficiency at $U_{out\ rated}$, $I_{out\ rated}$ 120 V / 240 V AC approx.	88.0 % / 89.0 %	88.6 % / 90.2 %	92.2 % / 93.0 %	94.0 % / 95.5 %
Power loss at $U_{out\ rated}$, $I_{out\ rated}$ 120 V / 240 V AC approx.	12 W / 12 W	16 W / 14 W	21 W / 19 W	31 W / 23 W
Power loss when idling 120 V / 240 V AC approx.	1.5 W / 2.3 W	1.3 W / 2 W	2.6 W / 2.2 W	2.5 W / 2.5 W

	6EP3344-7SB00-3AX0 (48 V/5 A)	6EP3346-7SB00-3AX0 (48 V/10 A)
Efficiency at $U_{out\ rated}$, $I_{out\ rated}$ 120 V / 240 V AC approx.	92.2 % / 93.0 %	94.0 % / 95.5 %
Power loss at $U_{out\ rated}$, $I_{out\ rated}$ 120 V / 240 V AC approx.	21 W / 19 W	31 W / 23 W
Power loss when idling 120 V / 240 V AC approx.	2.6 W / 2.2 W	2.5 W / 2.5 W

6.3 Efficiency

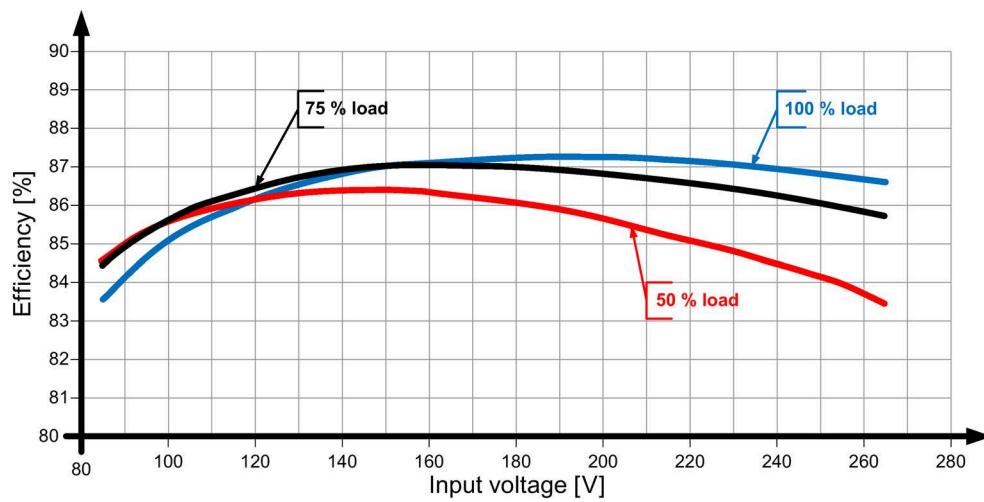

Figure 6-16 Efficiency 6EP3323-7SB00-0AXO

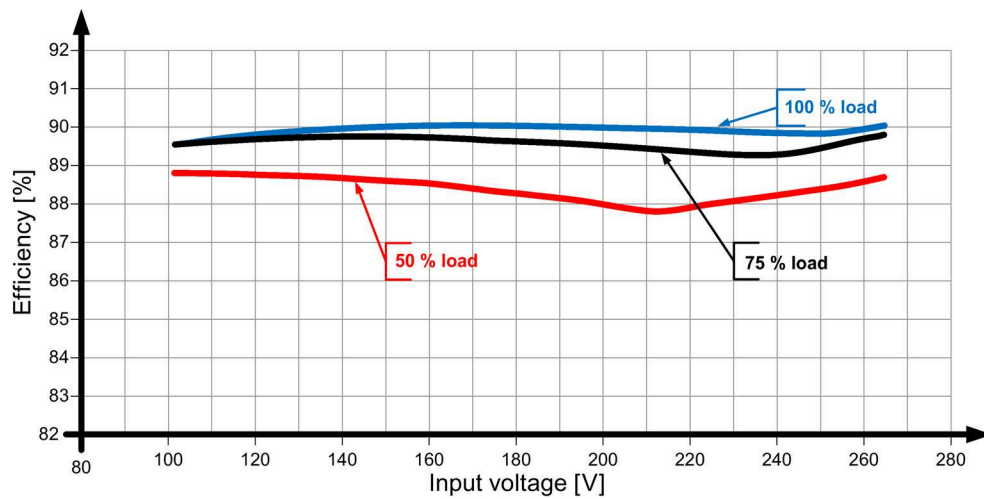

Figure 6-17 Efficiency 6EP3324-7SB00-3AXO

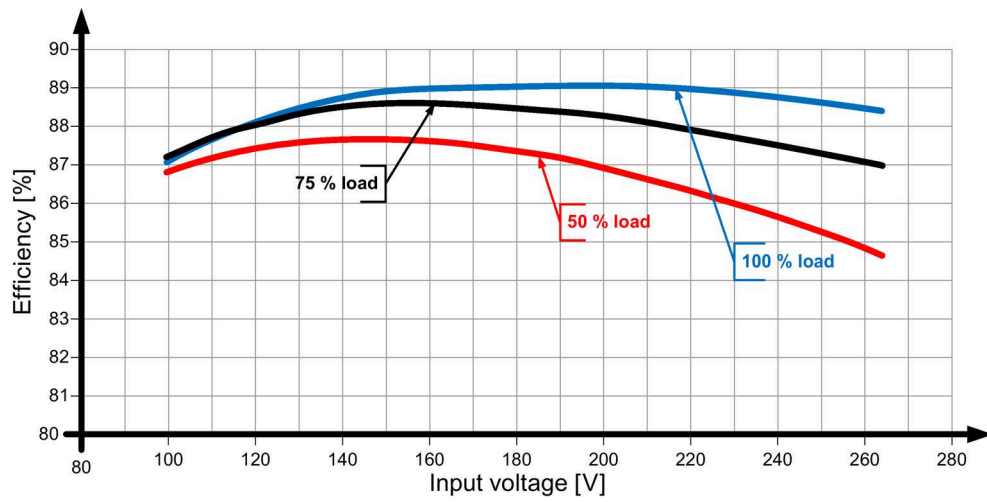

Figure 6-18 Efficiency 6EP3333-7LB00-0AX0

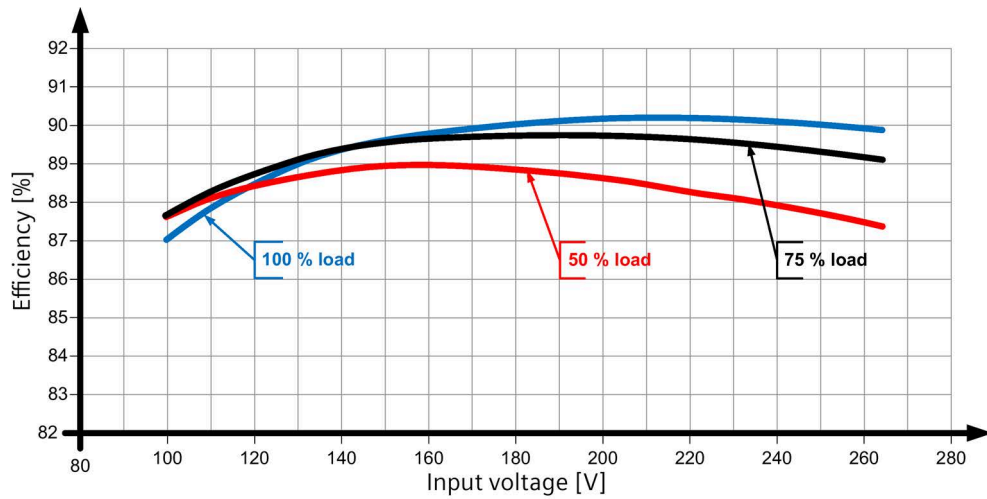

Figure 6-19 Efficiency 6EP3333-7SB00-0AX0 and 6EP3333-7SC00-0AX0

6.3 Efficiency

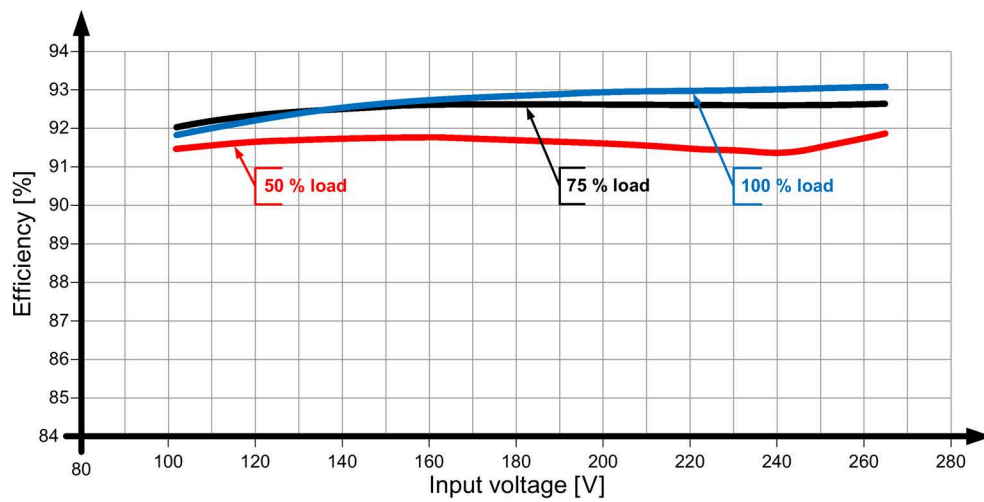

Figure 6-20 Efficiency 6EP3334-7SB00-3AX0 and 6EP3334-7SC00-3AX0

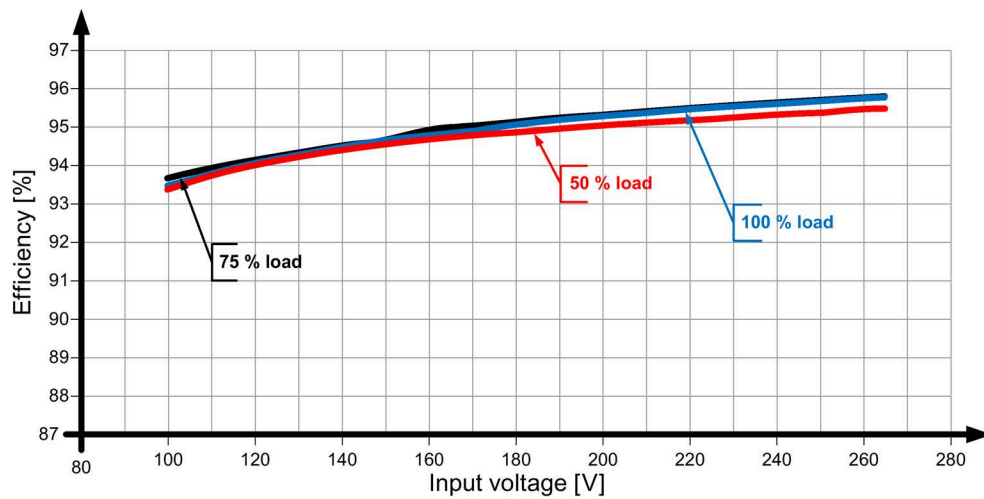

Figure 6-21 Efficiency 6EP3336-7SB00-3AX0 and 6EP3336-7SC00-3AX0

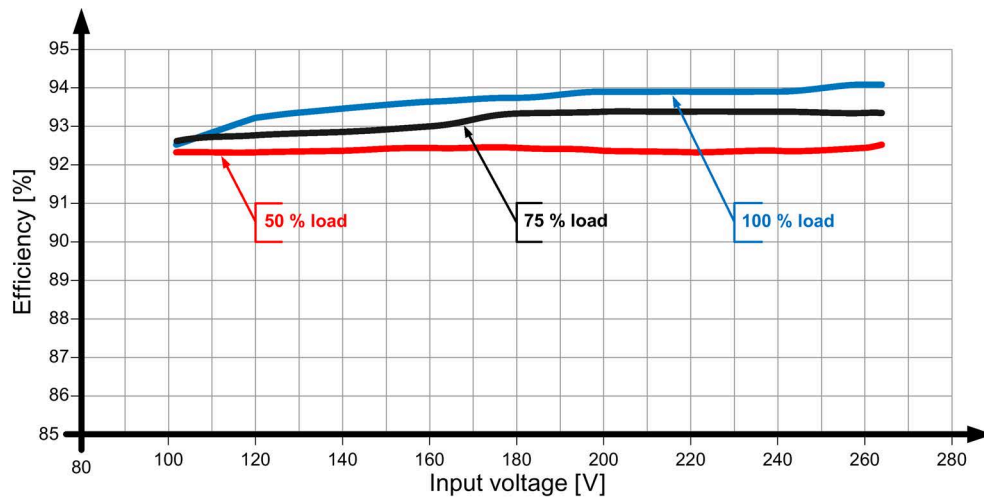

Figure 6-22 Efficiency 6EP3344-7SB00-3AX0

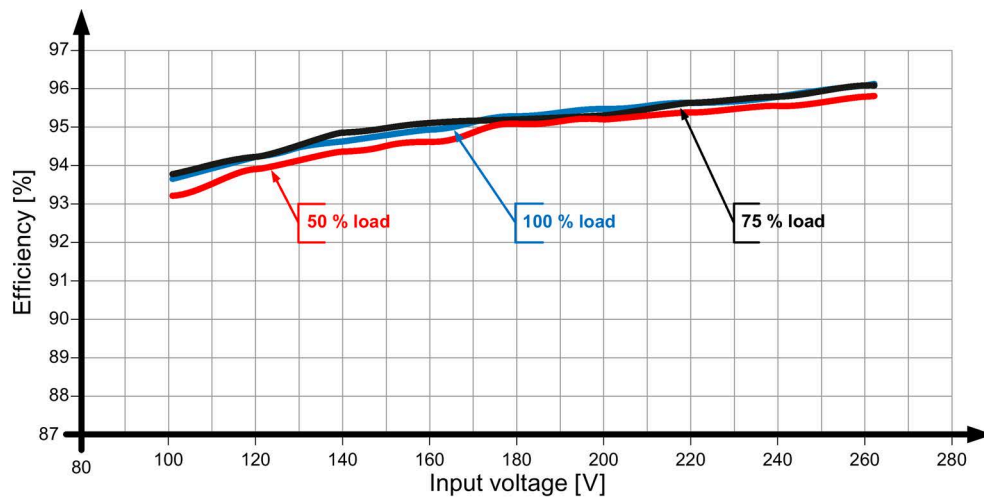

Figure 6-23 Efficiency 6EP3346-7SB00-3AX0

6.4 Closed-loop control

	6EP3323-7SB00-0AX0 (12 V/7 A)	6EP3324-7SB00-3AX0 (12 V/12 A)	
Dyn. line regulation ($U_{in\ rated} \pm 15\%$), max.	0.3 % U_{out}	0.3 % U_{out}	
Dyn. load regulation ($I_{out}: 10/90/10\%$), max.	$\pm 5\%$ U_{out}	$\pm 5\%$ U_{out}	
Dyn. load regulation ($I_{out}: 10/90/10\%$), typ.	$\pm 3\%$ U_{out}	$\pm 3\%$ U_{out}	
Load step regulation time 10 to 90 %, max.	1 ms	1 ms	
Load step regulation time 10 to 90 %, typ.	0.5 ms	0.5 ms	
Load step regulation time 90 to 10 %, max.	1 ms	1 ms	
Load step regulation time 90 to 10 %, typ.	0.5 ms	0.5 ms	

	6EP3333-7LB00-0AX0 (24 V/3.7 A)	6EP3334-7SB00-3AX0 6EP3334-7SC00-3AX0 (24 V/10 A)	6EP3336-7SB00-3AX0 6EP3336-7SC00-3AX0 (24 V/20 A)
Dyn. line regulation ($U_{in\ rated} \pm 15\%$), max.	0.3 % U_{out}	0.3 % U_{out}	0.3 % U_{out}
Dyn. load regulation ($I_{out}: 10/90/10\%$), max.	$\pm 5\%$ U_{out}	$\pm 5\%$ U_{out}	$\pm 5\%$ U_{out}
Dyn. load regulation ($I_{out}: 10/90/10\%$), typ.	$\pm 3\%$ U_{out}	$\pm 3\%$ U_{out}	$\pm 3\%$ U_{out}
Load step regulation time 10 to 90 %, max.	1 ms	1 ms	1 ms
Load step regulation time 10 to 90 %, typ.	0.5 ms	0.5 ms	0.5 ms
Load step regulation time 90 to 10 %, max.	1 ms	1 ms	1 ms
Load step regulation time 90 to 10 %, typ.	0.5 ms	0.5 ms	0.5 ms

	6EP3344-7SB00-3AX0 (48 V/5 A)	6EP3346-7SB00-3AX0 (48 V/10 A)
Dyn. line regulation ($U_{in rated} \pm 15\%$), max.	0.3 % U_{out}	0.3 % U_{out}
Dyn. load regulation ($I_{out}: 10/90/10\%$), max.	$\pm 5\%$ U_{out}	$\pm 5\%$ U_{out}
Dyn. load regulation ($I_{out}: 10/90/10\%$), typ.	$\pm 3\%$ U_{out}	$\pm 3\%$ U_{out}
Load step regulation time 10 to 90 %, max.	1 ms	1 ms
Load step regulation time 10 to 90 %, typ.	0.5 ms	0.5 ms
Load step regulation time 90 to 10 %, max.	1 ms	1 ms
Load step regulation time 90 to 10 %, typ.	0.5 ms	0.5 ms

6.5 Protection and monitoring

	6EP3323-7SB00-0AX0 (12 V/7 A)		6EP3324-7SB00-3AX0 (12 V/12 A)	
Output overvoltage protection	in the case of an internal fault $U_{out} < 20$ V		in the case of an internal fault $U_{out} < 20$ V	
Current limitation, typ.	9.3 A		14.7 A	
• Remark	Overload capability with 150 % $I_{out rated}$ up to 5 s/min		Overload capability with 150 % $I_{out rated}$ up to 5 s/min	
Short-circuit protection	Electronic trip, automatic restart (hiccup)			
Overload / short-circuit display	-		Diagnostics monitor, see Chapter Status displays and signaling (Page 13)	

	6EP3333-7LB00-0AX0 (24 V/3.7 A)	6EP3333-7SB00-0AX0 6EP3333-7SC00-0AX0 (24 V/5 A)	6EP3334-7SB00-3AX0 6EP3334-7SC00-3AX0 (24 V/10 A)	6EP3336-7SB00-3AX0 6EP3336-7SC00-3AX0 (24 V/20 A)
Output overvoltage protection	in the case of an internal fault $U_{out} < 32$ V			
Current limitation, typ.	3.7 A	6.5 A	12.2 A	24.5 A
• Remark		Overload capability with 150 % $I_{out rated}$ up to 5 s/min	Overload capability with 150 % $I_{out rated}$ up to 5 s/min	Overload capability with 150 % $I_{out rated}$ up to 5 s/min
Short-circuit protection	electronic trip, automatic restart (hiccup)			
Overload / short-circuit display	-	-	Diagnostics monitor, see Chapter Status displays and signaling (Page 13)	

	6EP3344-7SB00-3AX0 (48 V/5 A)	6EP3346-7SB00-3AX0 (48 V/10 A)
Output overvoltage protection	in the case of an internal fault $U_{out} < 32$ V	
Current limitation, typ.	12.2 A	24.5 A
• Remark	Overload capability with 150 % $I_{out rated}$ up to 5 s/min	Overload capability with 150 % $I_{out rated}$ up to 5 s/min
Short-circuit protection	electronic trip, automatic restart (hiccup)	
Overload / short-circuit display	Diagnostics monitor, see Chapter Status displays and signaling (Page 13)	

6.6 MTBF

6EP3323-7SB00-0AX0 (12 V/7 A)	6EP3333-7LB00-0AX0 (24 V/3.7 A)	6EP3344-7SB00-3AX0 (48 V/5 A)
6EP3324-7SB00-3AX0 (12 V/12 A)	6EP3333-7SB00-0AX0 6EP3333-7SC00-0AX0 (24 V/5 A)	6EP3346-7SB00-3AX0 (48 V/10 A)
	6EP3334-7SB00-3AX0 6EP3334-7SC00-3AX0 (24 V/10 A)	
	6EP3336-7SB00-3AX0 6EP3336-7SC00-3AX0 (24 V/20 A)	
Mean Time Between Failures	SN29500: > 500000 h at 40 °C, rated load, 24 h operation	

6.7 Mechanical system

	6EP3323-7SB00-0AX0 (12 V/7 A) 6EP3324-7SB00-3AX0 (12 V/12 A)
Connection system	Spring-loaded terminal
Connections: Line input	L, N, PE: 1 spring-loaded terminal each for 4 mm ² solid and 2.5 mm ² finely stranded conductors
Connections: Output	2 spring-loaded terminals for "+" and 3 spring-loaded terminals for "-" for 4 mm ² solid and 2.5 mm ² finely stranded
Connections: Auxiliary contacts	Signaling contact: 2 spring-loaded terminals for 1.5 mm ²
Width of the housing	35 mm
Height of the housing	135 mm
Depth of the housing	125 mm
Installation width	35 mm
Mounting height	225 mm
Weight, approx.	0.7 kg
Product feature of the housing: housing that can be lined up next to one another	Yes
Type of mounting: Wall/panel mounting	No
Type of mounting: Rail mounting	Yes
Type of mounting: S7-300 rail mounting	No
Mounting	Can be snapped onto standard TH35-15/7,5 mounting rails (EN 60715)

	6EP3333-7LB00-0AX0 (24 V/3.7 A)	6EP3333-7SB00-0AX0 6EP3333-7SC00-0AX0 (24 V/5 A) 6EP3334-7SB00-3AX0 6EP3334-7SC00-3AX0 (24 V/10 A)	6EP3336-7SB00-3AX0 6EP3336-7SC00-3AX0 (24 V/20 A)
Connection system	Spring-loaded terminal		
Connections: Line input	L, N, PE: 1 spring-loaded terminal each for 4 mm ² solid and 2.5 mm ² finely stranded conductors		L, N, PE: 1 spring-loaded terminal each for 4 mm ² solid and 2.5 mm ² finely stranded conductors
Connections: Output	2 spring-loaded terminals for "+" and 3 spring-loaded terminals for "-" for 4 mm ² solid and 2.5 mm ² finely stranded		2 spring-loaded terminals for "+" and 3 spring-loaded terminals for "-" for 10 mm ² solid and 6 mm ² finely stranded
Connections: Auxiliary contacts	Signaling contact: 2 spring-loaded terminals for 1.5 mm ²		
Width of the housing	35 mm	45 mm	70 mm
Height of the housing	135 mm	135 mm	135 mm
Depth of the housing	125 mm	125 mm	155 mm
Installation width	35 mm	45 mm	70 mm
Mounting height	225 mm	225 mm	225 mm
Weight, approx.	0.7 kg	0.9 kg	1.5 kg
Product feature of the housing: housing that can be lined up next to one another	Yes		
Type of mounting: Wall/panel mounting	No		
Type of mounting: Rail mounting	Yes		
Type of mounting: S7-300 rail mounting	No		
Mounting	Can be snapped onto standard TH35-15/7,5 mounting rails (EN 60715)		

Technical data

6.7 Mechanical system

	6EP3344-7SB00-3AX0 (48 V/5 A)	6EP3346-7SB00-3AX0 (48 V/10 A)
Connection system	Spring-loaded terminal	
Connections: Line input	L, N, PE: 1 spring-loaded terminal each for 4 mm ² solid and 2.5 mm ² finely stranded conductors	L, N, PE: 1 spring-loaded terminal each for 4 mm ² solid and 2.5 mm ² finely stranded conductors
Connections: Output	2 spring-loaded terminals for "+" and 3 spring-loaded terminals for "-" for 4 mm ² solid and 2.5 mm ² finely stranded	2 spring-loaded terminals for "+" and 3 spring-loaded terminals for "-" for 10 mm ² solid and 6 mm ² finely stranded
Connections: Auxiliary contacts	Signaling contact: 2 spring-loaded terminals for 1.5 mm ²	
Width of the housing	45 mm	70 mm
Height of the housing	135 mm	135 mm
Depth of the housing	125 mm	155 mm
Installation width	45 mm	70 mm
Mounting height	225 mm	225 mm
Weight, approx.	0.9 kg	1.5 kg
Product feature of the housing: housing that can be lined up next to one another	Yes	
Type of mounting: Wall/panel mounting	No	
Type of mounting: Rail mounting	Yes	
Type of mounting: S7-300 rail mounting	No	
Mounting	Can be snapped onto standard TH35-15/7,5 mounting rails (EN 60715)	

6.8 Accessories

	6EP3333-7LB00-0AX0 (24 V/3.7 A)	6EP3323-7SB00-0AX0 (12 V/7 A)
	6EP3333-7SB00-0AX0	6EP3324-7SB00-3AX0
	6EP3333-7SC00-0AX0 (24 V/5 A)	(12 V/12 A)
	6EP3334-7SB00-3AX0	6EP3344-7SB00-3AX0 (48 V/5 A)
	6EP3334-7SC00-3AX0 (24 V/10 A)	6EP3346-7SB00-3AX0 (48 V/10 A)
	6EP3336-7SB00-3AX0	
	6EP3336-7SC00-3AX0 (24 V/20 A)	
Electrical accessories	Redundancy module, buffer module, selectivity module or DC UPS	Redundancy module SITOP RED1200
Mechanical accessories	Reference labeling plate (160 plates) 6ES7193-6LF30-0AW0	

6.9 Dimension drawing

See chapter Dimensions and weight (Page 19)

CAD data that can be downloaded from the Internet:

6EP3323-7SB00-0AX0

(http://www.automation.siemens.com/bilddb/index.aspx?objKey=G_KT01_XX_01489)

6EP3324-7SB00-3AX0

(http://www.automation.siemens.com/bilddb/index.aspx?objKey=G_KT01_XX_01492)

6EP3333-7LB00-0AX0

(http://www.automation.siemens.com/bilddb/index.aspx?objKey=G_KT01_XX_01501)

6EP3333-7SB00-0AX0

(http://www.automation.siemens.com/bilddb/index.aspx?objKey=G_KT01_XX_01504)

6EP3333-7SC00-0AX0

(http://www.automation.siemens.com/bilddb/index.aspx?objKey=G_KT01_XX_01718)

6EP3334-7SB00-3AX0

(http://www.automation.siemens.com/bilddb/index.aspx?objKey=G_KT01_XX_01507)

6EP3334-7SC00-3AX0

(http://www.automation.siemens.com/bilddb/index.aspx?objKey=G_KT01_XX_01721)

6EP3336-7SB00-3AX0

(http://www.automation.siemens.com/bilddb/index.aspx?objKey=G_KT01_XX_01510)

6EP3336-7SC00-3AX0

(http://www.automation.siemens.com/bilddb/index.aspx?objKey=G_KT01_XX_01724)

6EP3346-7SB00-3AX0

(http://www.automation.siemens.com/bilddb/index.aspx?objKey=G_KT01_XX_01516)

6EP3344-7SB00-3AX0

(http://www.automation.siemens.com/bilddb/index.aspx?objKey=G_KT01_XX_01513)

Safety, approvals, EMC

7.1 Safety

	6EP3323-7SB00-0AX0 (12 V/7 A)	6EP3333-7LB00-0AX0 (24 V/3.7 A)	6EP3344-7SB00-3AX0 (48 V/5 A)
	6EP3324-7SB00-3AX0 (12 V/12 A)	6EP3333-7SB00-0AX0 6EP3333-7SC00-0AX0 (24 V/5 A)	6EP3346-7SB00-3AX0 (48 V/10 A)
		6EP3334-7SB00-3AX0 6EP3334-7SC00-3AX0 (24 V/10 A)	
		6EP3336-7SB00-3AX0 6EP3336-7SC00-3AX0 (24 V/20 A)	
Primary/secondary galvanic isolation	Yes		
Galvanic isolation	SELV (ES1) output voltage U_{out} acc. to EN 61204-7 and EN 50178 Transformer according to EN 61558-2-16		
Protection class	Class I		
Degree of protection (EN 60529)	IP20		
Leakage current, typ.	1 mA		
Leakage current, max.	3.5 mA		
Test voltage	see Table 7-1 Test voltage (Page 74)		

7.2 Test voltage

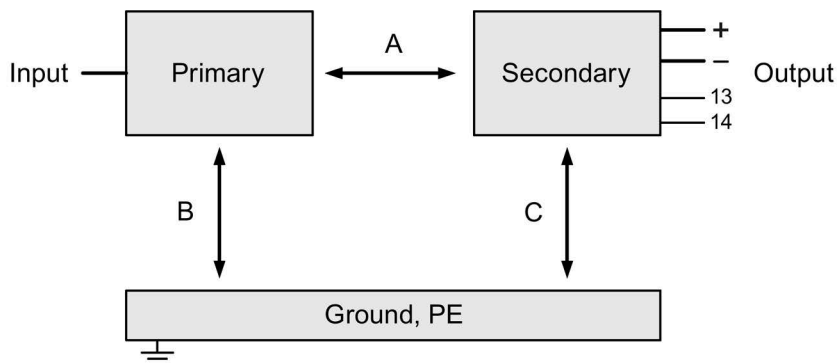

Figure 7-1 Test voltage diagram

Only the manufacturer can perform the type test and production test; users can also perform the field test.

Preconditions for performing the field test:

Tests (A) & (B)

- Connect the input terminals with one another (L1, N (L2))
- Connect the output terminals, signaling contact and PE with one another

Test (C)

- Connect the output terminals and signaling contact with one another and measure with respect to PE

Table 7- 1 Test voltage

	Test time	Prim ↔ sec (A)	Prim ↔ PE (B)	Sec ↔ PE (C)
Type test	60 s	4200 V DC	2200 V DC	850 V DC
Production test	1 s	4200 V DC	2200 V DC	850 V DC
Field test	1 s	4200 V DC	2200 V DC	850 V DC

Remark:

Tripping current for DC measurement: max. 10 mA

7.3 Approvals

	6EP3323-7SB00-0AX0 (12 V/7 A)	6EP3333-7LB00-0AX0 (24 V/3.7 A)	6EP3344-7SB00-3AX0 (48 V/5 A)
	6EP3324-7SB00-3AX0 (12 V/12 A)	6EP3333-7SB00-0AX0 (24 V/5 A)	6EP3346-7SB00-3AX0 (48 V/10 A)
		6EP3334-7SB00-3AX0 (24 V/10 A)	
		6EP3336-7SB00-3AX0 (24 V/20 A)	
CE marking	Yes, (2014/35/EU, 2014/30/EU and 2011/65/EU)		
CB certificate	Yes		
UL/cUL approval	cULus-listed (UL 508, CSA 22.2 No. 107.1), File E197259, for 6EP3333-7LB00-0AX0: NEC class2 (acc. to UL 60950-1/UL 1310), File E151273		
cCSAus approval	Yes, CSA C22.2 No. 62368-1		
SEMI F47	Yes (IEC 61000-4-11)		
Marine approval	Available soon		
RCM approval	Yes		
EAC approval	Yes		
SONCAP certificate	Yes		
	6EP3333-7SC00-0AX0 (24 V/5 A)	6EP3334-7SC00-3AX0 (24 V/10 A)	6EP3336-7SC00-3AX0 (24 V/20 A)
CE marking	Yes, (2014/35/EU, 2014/30/EU, 2011/65/EU and 2014/34/EU)		
CB certificate	Yes		
UL/cUL approval	cULus-listed (UL 508, CSA 22.2 No. 107.1), File E197259		
cCSAus approval	Yes, CSA C22.2 No. 62368-1		
Explosion protection	Yes		
ATEX approval	II 3G Ex ec IIC T3 Gc	II 3G Ex ec nC IIC T3 Gc	II 3G Ex ec nC IIC T4 Gc
IECEex approval	Yes	Yes	Yes
CCC HazLoc approval	II 3G Ex ec IIC T3 Gc	II 3G Ex ec nC IIC T3 Gc	II 3G Ex ec nC IIC T4 Gc
cULus HazLoc approval	Available soon		
SEMI F47	Yes		
Marine approval	Available soon		
RCM approval	Yes		
EAC approval	Yes		
SONCAP certificate	Yes		

7.4 EMC

		6EP3323-7SB00-0AX0 (12 V/7 A)	6EP3333-7LB00-0AX0 (24 V/3.7 A)	6EP3344-7SB00-3AX0 (48 V/5 A)
		6EP3324-7SB00-3AX0 (12 V/12 A)	6EP3333-7SB00-0AX0 6EP3333-7SC00-0AX0 (24 V/5 A)	6EP3346-7SB00-3AX0 (48 V/10 A)
			6EP3334-7SB00-3AX0 6EP3334-7SC00-3AX0 (24 V/10 A)	
			6EP3336-7SB00-3AX0 6EP3336-7SC00-3AX0 (24 V/20 A)	
Electrostatic discharge	EN 61000-4-2	8 kV contact, 8 kV air		
Electromagnetic fields	EN 61000-4-3	80 ... 1000 MHz 10 V/m 1400 ... 2000 MHz 10 V/m 2000 ... 2700 MHz 10 V/m 895 ... 905 MHz and 1.89 GHz 10 V/m		
High-speed transient disturbance variables (burst)	EN 61000-4-4	2 kV at line supply connections 1 kV at the DC output		
Surge voltages	EN 61000-4-5	2 kV symmetrical at the line connections 4 kV unsymmetrical at the line connections 500 V symmetrical/unsymmetrical at DC output cables		
High-frequency fields	EN 61000-4-6	10 V; 0.15 ... 80 MHz		
Magnetic fields	EN 61000-4-8	30 A/m; 50 Hz		
Voltage dips	EN 61000-4-11	100% for 20 ms, 60% for 200 ms, 30% for 500 ms		
Voltage interruptions	EN 61000-4-11	100% for 5000 ms		
Emitted interference	EN 55022	Class B		
Line harmonics limitation	EN 61000-3-2	Class A		
Generic standards	EN 61000-6-2	Immunity for industrial environments		
	EN 61000-6-3	Emission for residential areas		

Ambient conditions

	6EP3323-7SB00-0AX0 (12 V/7 A) 6EP3324-7SB00-3AX0 (12 V/12 A) 6EP3333-7LB00-0AX0 (24 V/3.7 A) 6EP3333-7SB00-0AX0 6EP3333-7SC00-0AX0 (24 V/5 A)	6EP3334-7SB00-3AX0 6EP3334-7SC00-3AX0 (24 V/10 A) 6EP3336-7SB00-3AX0 6EP3336-7SC00-3AX0 (24 V/20 A) 6EP3344-7SB00-3AX0 (48 V/5 A) 6EP3346-7SB00-3AX0 (48 V/10 A)
Ambient temperature	-25 ... 70 °C for natural convection (self convection)	-30 ... 70 °C for natural convection (self convection)
	Tested according to: <ul style="list-style-type: none"> • EN 60068-2-1 Cold • EN 60068-2-2 Dry heat • EN 60068-2-78 Humid heat, constant • EN 60068-2-14 Temperature change 	
Transport and storage temperature	-40 ... 85 °C Tests (packed for shipping) according to: <ul style="list-style-type: none"> • EN 60068-2-1 Cold • EN 60068-2-2 Dry heat • EN 60068-2-30 Humid heat, cyclic 	
Humidity class	Climatic class 3K3 acc. to EN 60721, 5 - 95 % without condensation	
Mechanical stressing in operation	Tested according to: <ul style="list-style-type: none"> • EN 60068-2-6 vibration, test Fc: 3.5 mm deflection in the range 5 – 8.4 Hz 2 g acceleration in the range 8.4 – 150 Hz • EN 60068-2-27 shock, test Ea: acceleration 150 m/s², test duration 11 ms 	

6EP3323-7SB00-0AX0 (12 V/7 A)	6EP3334-7SB00-3AX0
6EP3324-7SB00-3AX0 (12 V/12 A)	6EP3334-7SC00-3AX0 (24 V/10 A)
6EP3333-7LB00-0AX0 (24 V/3.7 A)	6EP3336-7SB00-3AX0
6EP3333-7SB00-0AX0	6EP3336-7SC00-3AX0 (24 V/20 A)
6EP3333-7SC00-0AX0 (24 V/5 A)	6EP3344-7SB00-3AX0 (48 V/5 A)
	6EP3346-7SB00-3AX0 (48 V/10 A)

Damaging gases

Tested according to:

- EN 60068-2-42 sulfur dioxide
- EN 60068-2-43 hydrogen sulfide

Atmospheric pressure

Operation:

- 1080 - 795 hPa (0 - 2000 m)
- For operation at altitudes of 2000 m up to 6000 m above sea level:
output must be derated by -7.5% / 1000 m or
the ambient temperature must be reduced by 5 K / 1000 m
see Figure 4-9 Mounting height derating (Page 26)
- Overvoltage category:
III to 2000 m (EN 50178)
II from 2000 m to 6000 m (EN 50178)
II to 2000 m (EN 61204-7)
I from 2000 m to 6000 m (EN 61204-7)

Storage:

- 1080 - 660 hPa (0 - 3500 m)

Applications

9.1 Parallel connection to increase the power rating

To increase the power rating, power supplies of the same type can be directly connected in parallel.

The following must be observed:

- The cables connected to each power supply at terminals "+" and "-" must have identical lengths and the same cable cross-sections (or the same impedance) up to a common external connection point (terminal strip) if possible.
- The power supplies connected in parallel must be switched on simultaneously with a common switch in the line feeder cable (e.g. with the main switch available in control cabinets).
- The output voltages measured in no-load operation for the power supplies that are not yet connected in parallel should not deviate more than a maximum of 50 mV. This usually corresponds to the factory setting. If the output voltage is changed, you should connect the "-" terminals and then, in no-load operation, measure the voltage difference between the "+" terminals that have not yet been connected. The voltage difference should not exceed 50 mV.

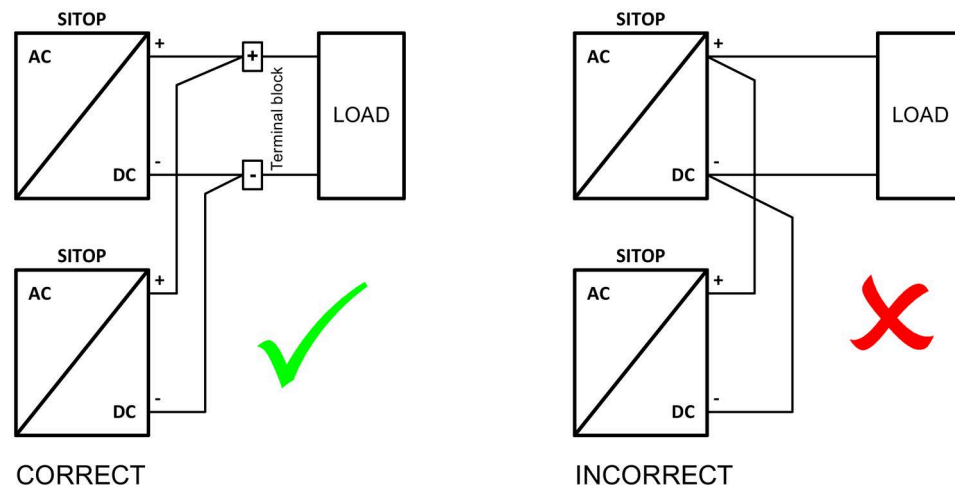

Figure 9-1 Parallel connection

Note

It is not permissible to take into account simultaneous overload capability (Extra-Power 150% for 5 s/min) of several power supplies connected in parallel when configuring the power supply system.

9.1 Parallel connection to increase the power rating

NOTICE

Protective circuit for the parallel connection of more than two power supplies

When connecting more than two power supplies in parallel, additional measures must be taken to prevent high reverse currents in the event of a secondary device fault. For this purpose, a suitable protective circuit (e.g. decoupling diode or DC-capable circuit breaker) must be installed between each "+" terminal of the power supply and the common connection point.

9.2 Series connection for increased voltage

To achieve an output voltage of 48 V DC, two 24 V SITOP power supplies of the same type can be connected in series.

Depending on the grounding point of the secondary output voltages, voltages of +48 V, ± 24 V or -48 V can be realized.

Note

For additional details, see Catalog KT 10.1 Chapter 15 Technical information and configuring (see (<https://support.industry.siemens.com/cs/ww/de/view/109745655>)).

! WARNING

SELV (ES1) in the case of fault, not guaranteed

When connecting two power supplies in series, SELV (ES1) according to EN 61204-7, cannot be guaranteed in the case of a fault.

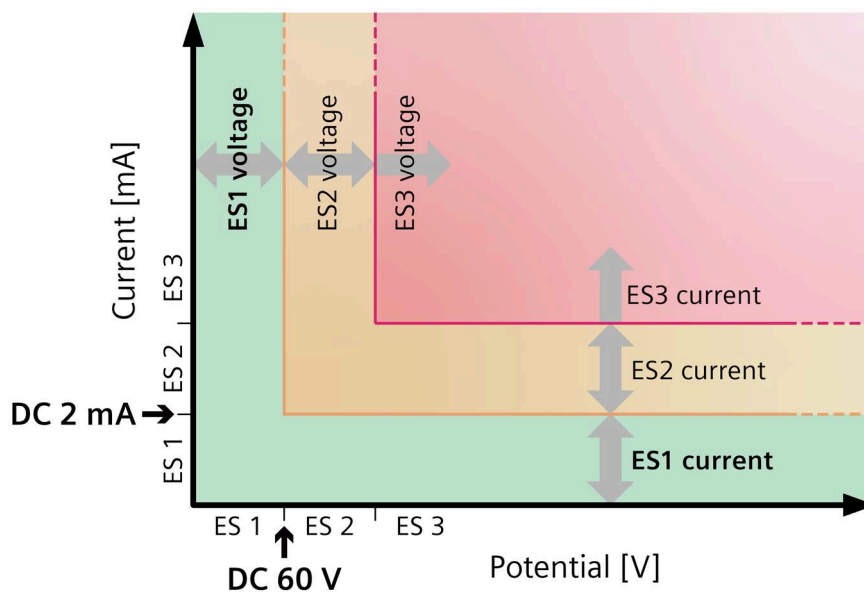

Figure 9-2 Representation of the ES limit values for voltage and current

To guarantee safe and reliable operation of the power supplies in all operating states, for the series circuit, the subsequent wiring using two redundancy modules SITOP RED1200 is recommended.

9.2 Series connection for increased voltage

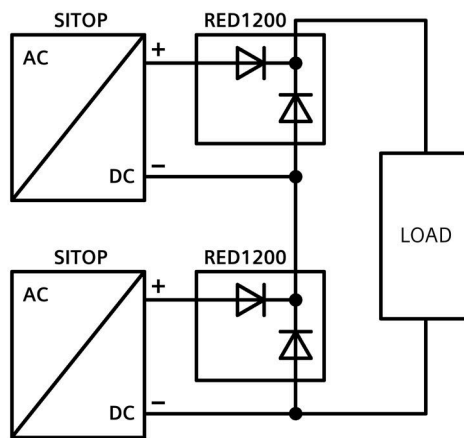

Figure 9-3 Series connection

9.3 Overload protection in the 24 V output circuit

If an overload occurs, the electronic current limiting function of the 24 V power supply limits the output current to a maximum value (see Section Technical data (Page 47)). The output cables are protected against a thermal overload if they are dimensioned corresponding to the maximum rms output current, or protected using additional components (for example, miniature circuit breaker, fuses).

However, a load circuit that fails as a result of overload, for instance, should frequently be reliably and quickly identified and specifically switched off before the power supply goes into current-limiting mode (in current-limiting mode, the supply voltage would also be reduced for all of the remaining 24 V loads).

The SITOP PSE200U selectivity module with 4 outputs (versions with adjustable output current range for each output from 0.5 - 3 A and 3 - 10 A) is available for this purpose; this monitors the 24 V branches for overload and short circuit (Figure 9-4 Electronic protection of 24 V loads using the SITOP PSE200U selectivity module (Page 83)). Brief current peaks, e.g. as a result of a high inrush current, are permitted, and branches with a longer overload are switched into a no-current condition. This is also ensured for cables in a high-ohmic condition and for short circuits that slowly develop over time.

When an output fails, the fault is signaled using a group signal contact or as a single channel signal, and the branch of the module involved is displayed using an LED.

For variants with single-channel signaling, function blocks for evaluation purposes are available for SIMATIC S7-1200/1500/300/400, for STEP 7 Classic and TIA Portal at no charge.

You can find additional information at:

Manual SITOP selectivity modules

(<https://support.industry.siemens.com/cs/ww/en/view/108989004>)

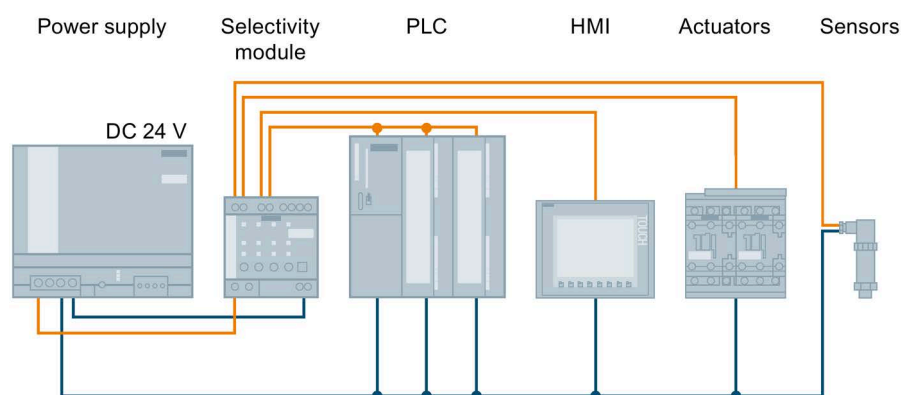

Figure 9-4 Electronic protection of 24 V loads using the SITOP PSE200U selectivity module

9.4 Protection against short-time voltage dips

For a drop in the line-side supply voltage, the 24 V power supply still maintains the output voltage for a short time in the millisecond range (see Chapter Technical data (Page 47)).

For line supplies that manifest frequent brief voltage dips, in order to increase the power supply reliability, it may make sense to increase the line buffering time in the device using an additional SITOP PSE201U buffer module.

The SITOP PSE201U buffer module, based on electrolytic capacitors, is connected in parallel to the power supply output (Figure 9-5 Buffering brief power failures using the SITOP PSE201U buffer module (Page 84)). The buffer time is 200 ms at 40 A up to 1.6 s for a load current of 5 A. This time can be increased a multiple number of times by connecting buffer modules in parallel; the maximum buffer time is 10 s.

You can find additional information at:

Manual SITOP expansion modules

(<https://support.industry.siemens.com/cs/ww/en/view/109768676>)

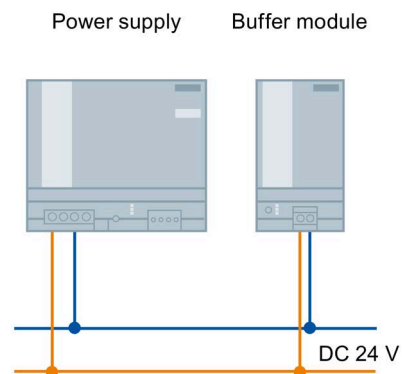

Figure 9-5 Buffering brief power failures using the SITOP PSE201U buffer module

9.5 Protecting against longer power failures

Sudden and longer failures of the line supply voltage can result in undefined states and significant danger as a result of the associated failure of the plant or system control. The SITOP power supply product portfolio includes various DC-UPS solutions to prevent the failure of the 24 V power supply voltage.

Power supply failures up into the minutes range can be buffered using the maintenance-free SITOP UPS500 DC-UPS modules based on capacitors (Figure 9-6 24 V buffering to allow the saving of process data and controlled shutdown of PCs (Page 85)).

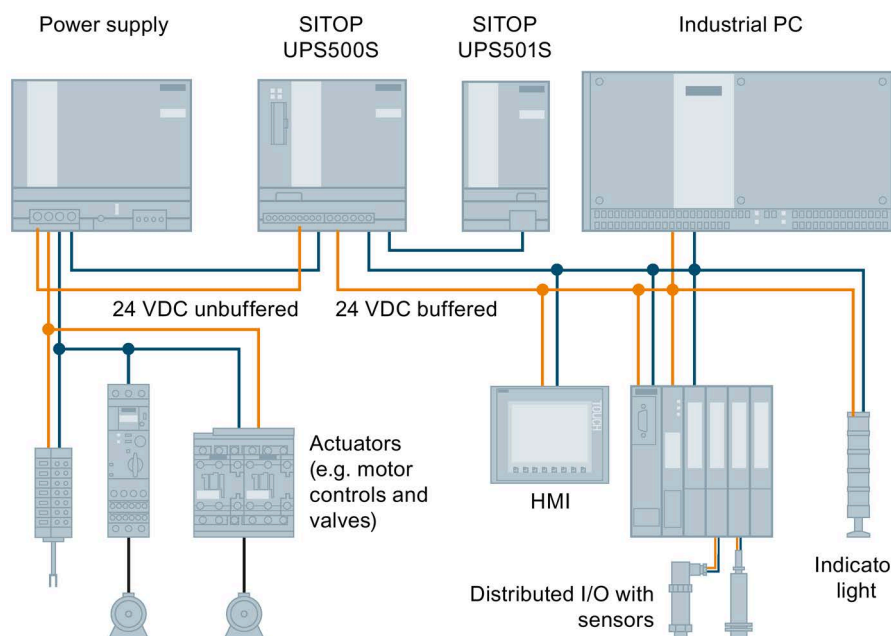

Figure 9-6 24 V buffering to allow the saving of process data and controlled shutdown of PCs

Using the free-of-charge SITOP DC-UPS software tool, DC-UPS systems can be simply integrated into PC-based automation solutions. This supports further processing of the status signals and safely running down the PC.

You can find additional information at:

Manual, DC UPS with capacitors

(<https://support.industry.siemens.com/cs/ww/en/ps/18042/man>)

Using the SITOP UPS1600 DC UPS and battery modules SITOP BAT1600 or SITOP UPS1100, buffer times in the range of hours can be implemented. Intelligent battery management using Energy Storage Link automatically detects the UPS1100 energy storage device, and ensures optimum temperature-controlled charging and continuous monitoring. The UPS1600 with its digital inputs/outputs as well as optional USB interface or Ethernet/PROFINET port can be flexibly integrated into the widest range of automation applications.

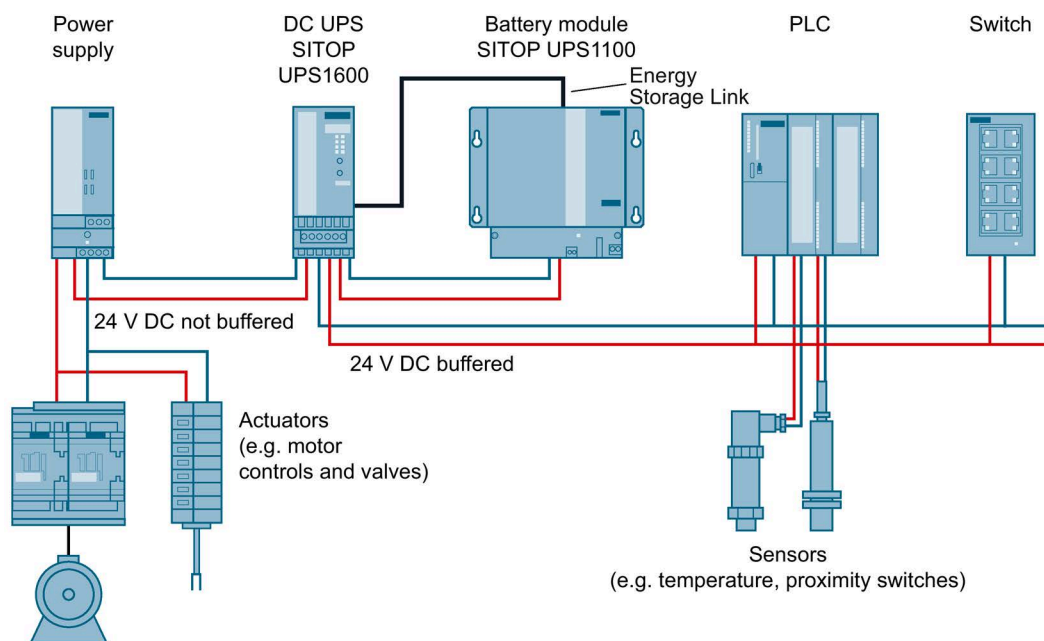

Figure 9-7 24 V buffering with SITOP UPS1600 to maintain communication, signaling functions, sensor measured values and position values

For open, PC-based automation systems, configuration and monitoring is realized using the free-of-charge SITOP Manager, or for devices with an older software release, using PC software SITOP UPS Manager (compatibility list, see DC-UPS Manual SITOP UPS1600//BAT1600/UPS1100 (<https://support.industry.siemens.com/cs/ww/en/view/84977415>)). This allows PC responses to the operating states of the DC UPS to be freely selected – and offers comprehensive diagnostic functions.

For TIA-based automation systems, the UPS1600 is engineered using the TIA Portal. Special function blocks for SIMATIC S7-300/400/1200 and S7-1500 are available at no charge, and make it easy to integrate operating and diagnostics information into STEP 7 user programs. Preconfigured UPS faceplates for WinCC visualization can be downloaded at no charge.

You can find additional information at:

Manual DC-USV SITOP UPS1600/BAT1600/UPS1100
(<https://support.industry.siemens.com/cs/ww/en/view/84977415>)

Environment

The devices are in conformance with RoHS.

Only substances in conformance with PWIS are used (paint-wetting impairment substances).

Disposal guidelines



Packaging and packaging aids can and should always be recycled. The product itself may not be disposed of as domestic refuse.

Service & Support

Service & Support Portal

On the main support page, you can find a wealth of useful information about the range of services we offer, documents, downloads and much more:

Industry Online Support (<https://support.industry.siemens.com>)

Technical support

You can access technical support through the following communication channels:

- Internet:
Web form for support request (<http://www.siemens.com/SupportRequest>)
- Smartphone:
Siemens Industry Online Support App
(<https://new.siemens.com/global/en/products/software/mobile-apps/industry-online-support.html>)

Technical documentation on the Internet

Operating instructions and manuals for SITOP are available in the Internet:

Operating instructions/manuals (<https://www.siemens.com/sitop-manuals>)

SITOP power supply homepage

Current information about our power supplies is available in the Internet at the SITOP home page:

SITOP (<http://www.siemens.com/sitop>)

Texts for invitation to tender

You can find invitation to tender texts for SITOP power supplies here:

Link to the portal (<http://www.siemens.de/ausschreibungstexte>)

CAX data

You can find 2D-/3D data, devices circuit diagrams according to IEC and ANSI as well as EPLAN macros as download in the Internet:

Siemens image database (<http://www.siemens.com/sitop-cax>)

Request all CAX data via the CAX download manager:

CAX shopping cart (<http://www.siemens.com/cax>)

TIA Selection Tool

Simply and quickly select the optimum power supply, add-on modules and DC-UPS:

TIA Selection Tool cloud (<http://www.siemens.com/tst-powersupply>)

In addition, the 24 V load view in the TIA Selection Tool allows you to simply select the power supply for your particular project as the current demand of the automation products being

supplied is automatically calculated.

Download the TIA Selection Tool (<http://www.siemens.de/tia-selection-tool-standalone>)

Online catalog and ordering system

The online catalog and the online ordering system are available through the Industry Mall homepage:

Industry Mall (<http://www.siemens.com/industrymall/de>)

Contact persons

If you have any questions regarding the use of our products, then contact the Siemens contact person in your regional Siemens sales office.

You can find these addresses as follows:

- Internet (<http://www.automation.siemens.com/partner>)
- Industry Mall (<http://www.siemens.com/industrymall/de>)