

SITOP power supply

Selectivity modules

Manual

SITOP select 4 x 10 A
6EP1961-2BA00

SITOP PSE200U 4 x 3 A
6EP1961-2BA11
6EP1961-2BA31
6EP1961-2BA51
6EP1961-2BA61

SITOP PSE200U 4 x 10 A
6EP1961-2BA21
6EP1961-2BA41

Overview

Safety notes

1

Description, device design,
dimension drawing

2

Mounting/removal

3

Mounting position, mounting
clearances

4

Installation

5

Technical data

6

Safety, approvals, EMC

7

Environmental conditions

8

Environment

9



Service & Support

10

Legal information

Warning notice system

This manual contains notices you have to observe in order to ensure your personal safety, as well as to prevent damage to property. The notices referring to your personal safety are highlighted in the manual by a safety alert symbol, notices referring only to property damage have no safety alert symbol. These notices shown below are graded according to the degree of danger.

 DANGER
indicates that death or severe personal injury will result if proper precautions are not taken.
 WARNING
indicates that death or severe personal injury may result if proper precautions are not taken.
 CAUTION
indicates that minor personal injury can result if proper precautions are not taken.
NOTICE
indicates that property damage can result if proper precautions are not taken.

If more than one degree of danger is present, the warning notice representing the highest degree of danger will be used. A notice warning of injury to persons with a safety alert symbol may also include a warning relating to property damage.

Qualified Personnel

The product/system described in this documentation may be operated only by **personnel qualified** for the specific task in accordance with the relevant documentation, in particular its warning notices and safety instructions. Qualified personnel are those who, based on their training and experience, are capable of identifying risks and avoiding potential hazards when working with these products/systems.

Proper use of Siemens products

Note the following:

 WARNING
Siemens products may only be used for the applications described in the catalog and in the relevant technical documentation. If products and components from other manufacturers are used, these must be recommended or approved by Siemens. Proper transport, storage, installation, assembly, commissioning, operation and maintenance are required to ensure that the products operate safely and without any problems. The permissible ambient conditions must be complied with. The information in the relevant documentation must be observed.

Trademarks

All names identified by ® are registered trademarks of Siemens AG. The remaining trademarks in this publication may be trademarks whose use by third parties for their own purposes could violate the rights of the owner.

Disclaimer of Liability

We have reviewed the contents of this publication to ensure consistency with the hardware and software described. Since variance cannot be precluded entirely, we cannot guarantee full consistency. However, the information in this publication is reviewed regularly and any necessary corrections are included in subsequent editions.

Overview

Description



Figure 1 View of devices

In conjunction with a 24 V power supply, the selectivity module is used to distribute the load current across several branches and to monitor the individual currents in these branches. Faults in the individual branches caused by overload or short-circuit are detected and selectively switched off, so that the fault does not impact the other load circuits. This means fast troubleshooting and minimized downtimes.

The key benefits of the product include:

- A maximum of 4 load branches are monitored for each module
- The response threshold can be continually set for each output using a potentiometer
- Overcurrents are reliably switched off, independent of the cable length and cable cross-section
- The 24 V supply for the other loads is maintained
- Multi-colored LED for each output for faster troubleshooting on-site
- Floating group signal contact for remote diagnostics (for -2BA00, -2BA11, -2BA21, -2BA51)
- Single-channel signal to serially indicate the state of the individual outputs (for -2BA31, -2BA41, -2BA61)
- Evaluation using free-of-charge SIMATIC S7 function blocks (S7-300/400/1200/1500) for modules with single channel signal
- It can be selected that the load branches are sequentially switched on to reduce the total inrush current
- Versions for limited output power ratings according to NEC Class 2 (maximum, 100 VA).

Ordering data

The following device options are available:

Selectivity modules	
Type	Order number
SITOP select 24 V DC input Number of outputs: 4 Setting range of the response threshold: 2 - 10 A with group signaling contact	6EP1961-2BA00
SITOP PSE200U 24 V DC input Number of outputs: 4 Setting range of the response threshold: 0.5 - 3 A with group signaling contact	6EP1961-2BA11
SITOP PSE200U 24 V DC input Number of outputs: 4 Setting range of the response threshold: 3 - 10 A with group signaling contact	6EP1961-2BA21
SITOP PSE200U 24 V DC input Number of outputs: 4 Setting range of the response threshold: 0.5 - 3 A with group signaling contact	6EP1961-2BA31
SITOP PSE200U 24 V DC input Number of outputs: 4 Setting range of the response threshold: 3 - 10 A with group signaling contact	6EP1961-2BA41
SITOP PSE200U 24 V DC input Number of outputs: 4 Setting range of the response threshold: 0.5 - 3 A with group signaling contact, NEC Class 2	6EP1961-2BA51
SITOP PSE200U 24 V DC input Number of outputs: 4 Setting range of the response threshold: 0.5 - 3 A with single-channel signal, NEC Class 2	6EP1961-2BA61

Accessories	
Type	Order number
Flat insertable fuse: Manufacturer, Littelfuse, series FKS or PXS, 19 mm long (for 6EP1961-2BA00)	02870*.PXS, 166.7000.* (FKS-80)
Device name plate 20 mm × 7 mm, T1 grey (for 6EP1961-2BA11, -2BA21, -2BA31, -2BA41, -2BA51, -2BA61)	3RT2900-1SB20

Validity

This manual provides information on the following products:

- Selectivity module SITOP select 10 A
Article number: 6EP1961-2BA00
Product State: 4
- Selectivity module SITOP PSE200U 3 A
Article number: 6EP1961-2BA11, 6EP1961-2BA31
Product state: 3
changes with respect to the previous version (PS: 2):
– temperature range extended to -25 ... 60 °C
– terminal labeling changed from "NC" to "NF"
- Selectivity module SITOP PSE200U 3 A NEC Class 2
Article number: 6EP1961-2BA51, 6EP1961-2BA61
Product state: 2
changes with respect to the previous version (PS: 1):
– temperature range extended to -25 ... 60 °C
– terminal labeling changed from "NC" to "NF"
- Selectivity module SITOP PSE200U 10 A
Article number: 6EP1961-2BA21, 6EP1961-2BA41
Product state: 3
changes with respect to the previous version (PS: 2):
– temperature range extended to -25 ... 60 °C
– terminal labeling changed from "NC" to "NF"

Table of contents

	Overview.....	3
1	Safety notes.....	9
1.1	General safety instructions	9
1.2	Safety instructions for hazardous zones.....	10
1.2.1	SITOP select (6EP1961-2BA00)	10
1.2.2	SITOP PSE200U (6EP1961-2BA11, -2BA31, -2BA51, -2BA61, -2BA21, -2BA41)	10
2	Description, device design, dimension drawing	11
2.1	Device description.....	11
2.2	Connections and terminal designation.....	12
2.3	Potentiometer.....	14
2.4	Status displays and signaling	15
2.5	Buttons and selector switches	19
2.5.1	SITOP select.....	19
2.5.2	SITOP PSE200U	20
2.6	Electronic overload shutdown and reset.....	21
2.6.1	SITOP select.....	21
2.6.2	SITOP PSE200U	23
2.7	Setting the switch-on delay time	28
2.7.1	SITOP select.....	28
2.7.2	SITOP PSE200U	30
2.8	Block diagram	31
2.9	Dimensions and weight.....	33
3	Mounting/removal	35
4	Mounting position, mounting clearances.....	37
4.1	Standard mounting position	37
4.2	Other mounting positions.....	39
4.2.1	6EP1961-2BA00	39
4.2.2	6EP1961-2BA11, 6EP1961-2BA31, 6EP1961-2BA51 and 6EP1961-2BA61	41
4.2.3	6EP1961-2BA21 and 6EP1961-2BA41	43
5	Installation	45
5.1	Input side connection.....	45
5.2	Output-side connection	47
6	Technical data	49
6.1	Input	49
6.2	Output	50

6.3	Efficiency.....	55
6.4	Protection and monitoring.....	55
6.5	MTBF.....	56
6.6	Mechanical system.....	56
6.7	Accessories.....	57
6.8	Dimension drawing.....	58
7	Safety, approvals, EMC.....	59
7.1	Safety.....	59
7.2	Approvals.....	60
7.3	EMC.....	61
8	Environmental conditions.....	63
9	Environment.....	65
10	Service & Support.....	67

Safety notes

1.1 General safety instructions

 **WARNING**

Correct handling of the devices

When operating electrical devices, it is inevitable that certain components will carry dangerous voltages.

Therefore, failure to handle the units properly can result in death or serious physical injury as well as extensive property damage.

Only appropriately qualified personnel may work on or in the vicinity of this equipment.

Perfect, safe, and reliable operation of this equipment is dependent on proper transportation, storage, installation and mounting.

Before installation or maintenance work can begin, the system's main switch must be switched off and measures taken to prevent it being switched on again.

If this instruction is not observed, touching live parts can result in death or serious injury.

1.2 Safety instructions for hazardous zones

1.2.1 SITOP select (6EP1961-2BA00)

The device complies with ATEX directive 2014/34/EU; EN 60079-0; EN 60079-15.

 WARNING
--

OPERATE POTENTIOMETERS OR SWITCHES IN NON-HAZARDOUS AREAS ONLY! REMOVE / INSERT THE FUSE IN NON-HAZARDOUS AREAS ONLY!
--

1.2.2 SITOP PSE200U (6EP1961-2BA11, -2BA31, -2BA51, -2BA61, -2BA21, -2BA41)

The devices comply with ATEX directive 2014/34/EU; EN 60079-0; EN 60079-7.

 WARNING

OPERATE POTENTIOMETERS OR SWITCHES IN NON-HAZARDOUS AREAS ONLY!

Description, device design, dimension drawing

2

2.1 Device description

Using the selectivity module, a 24 V DC output voltage from a regulated power supply can be distributed across four load circuits. The response threshold of the output current can be individually set for each output using a potentiometer. When the set response threshold is exceeded, the output is automatically switched off according to a defined switch off characteristic, and can be switched on again after a wait time using a pushbutton or remote reset (SITOP PSE200U). The status of the output is displayed using a multi-color LED for each output. The status of the outputs can be processed via a group signaling contact or via a serial single-channel signal.

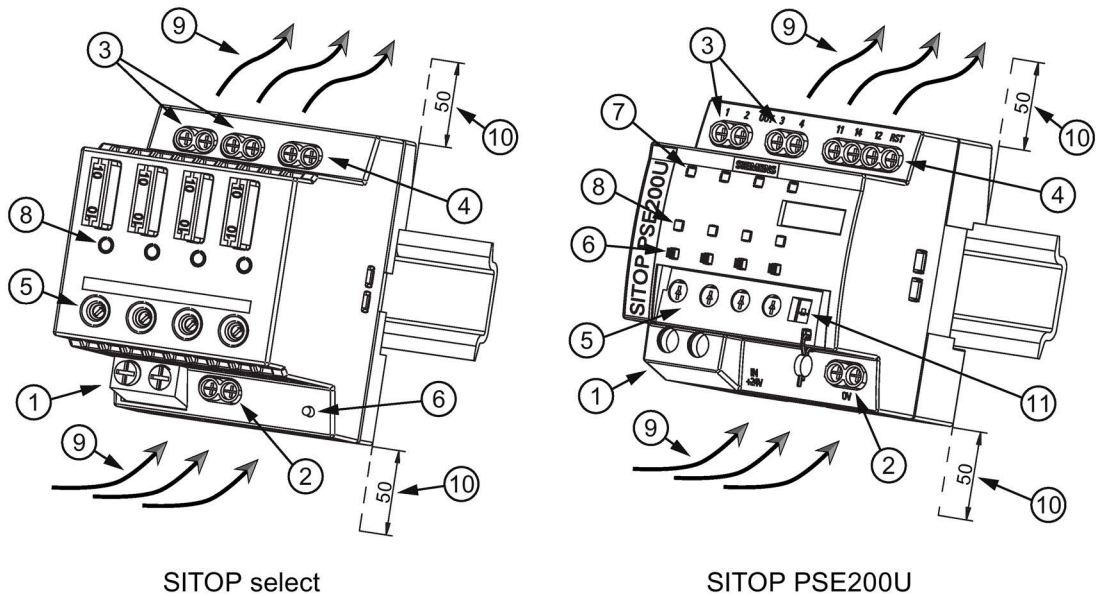

- ① +24 V input
- ② 0 V connection for the internal supply
- ③ +24 V outputs
- ④ Group signal contact/status output/remote reset input
- ⑤ Potentiometer for each output
- ⑥ Button
- ⑦ Measuring point
- ⑧ Indicator light for each output
- ⑨ Natural convection
- ⑩ Clearance above/below
- ⑪ Selector switch for switch-on delay

Figure 2-1 Design

2.2 Connections and terminal designation

The input terminals ① can be used to establish the connection to the supply voltage. The 0 V connection ② is used to supply the internal electronics. Output terminals ③ are used to connect to the loads to be supplied (also see Chapter Installation (Page 45)).





Using the group signal contact or status output ④, the operating state of the device can be processed (function and contact rating, see Chapter Figure 2-4 Operating displays and signaling (SITOP select and SITOP PSE200U) (Page 15)).

The remote reset input ④ is used to reset outputs that have been automatically shut down (function, see Chapter Status displays and signaling (Page 15)).

Connections and terminal designations for 6EP1961-2BA00	
① + 24 V input	2 screw terminals
② 0 V connection	2 screw terminals
③ + 24 V output: 1, 2, 3, 4	One screw terminal each
④ group signal contact (13, 14)	One screw terminal each

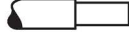
Connections and terminal designations for 6EP1961-2BA11, 6EP1961-2BA21 and 6EP1961-2BA51	
① + 24 V input	2 screw terminals
② 0 V connection	2 screw terminals
③ + 24 V output: 1, 2, 3, 4	One screw terminal each
④ group signal contact (11, 12, 14); remote reset (RST)	One screw terminal each

Connections and terminal designations for 6EP1961-2BA31, 6EP1961-2BA41 and 6EP1961-2BA61	
① + 24 V input	2 screw terminals
② 0 V connection	2 screw terminals
③ + 24 V output: 1, 2, 3, 4	One screw terminal each
④ not assigned (NF)	2 screw terminals
④ status output (S); remote reset (RST)	One screw terminal each

	①	② + ③ + ④	⑤
	1 x 5,5 / PZ2 / PH2	0,6 x 3,5 / PZ1	0,6 x 3,5 / PZ1
	0,5 - 16 mm ²	0,2 - 6 mm ²	-
	0,5 - 16 mm ²	0,2 - 4 mm ²	-
	2,5 - 10 mm ²	0,25 - 4 mm ²	-
AWG	26 - 6	24 - 10	-
Nm	1,2 - 1,5 Nm	0,5 Nm	0,04 Nm ^{*)}
	12 mm	8 mm	-

^{*)} Do not subject the end stop to higher loads

Figure 2-2 Terminal data

NOTICE
<p>Overload of the wiring</p> <p>The "0 V" connection is only used to supply the internal electronics of the selectivity module. The 0 V of the connected loads must be routed directly to the power supply using separate cables!</p>

2.3 Potentiometer

The potentiometer ⑤ on the front of the device is used to set the response threshold of the output current. When delivered, the maximum possible response threshold is set.

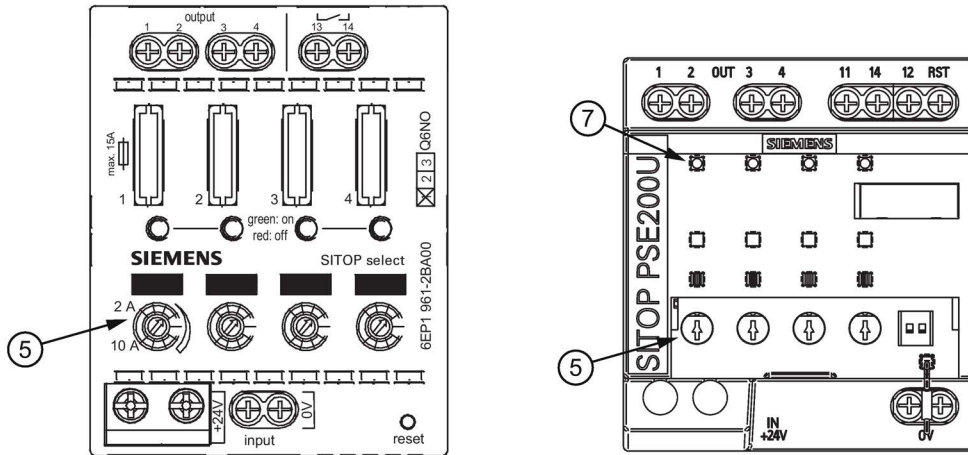

Figure 2-3 Potentiometer (SITOP select and SITOP PSE200U)

Note

It is only permissible to use an insulated screwdriver when actuating the potentiometer.

For information on actuating the potentiometer (screwdriver, torque), see Figure 2-2 Terminal data (Page 13).

Note

For SITOP PSE200U, the actual output current of a branch can be determined by measuring the voltage at measuring point "MP" ⑦ with respect to the "0 V" terminal. A measured voltage of 1 V corresponds to an output current of 1 A.

2.4 Status displays and signaling

	6EP1961-2BA00	6EP1961-2BA11 6EP1961-2BA21 6EP1961-2BA51	6EP1961-2BA31 6EP1961-2BA41 6EP1961-2BA61
Operating display ⑧	Two-color LED	Three-color LED	Three-color LED
Group signal contact (13, 14 or 11, 12, 14) ④	floating relay contact (NO contact), contact rating: 24 V/0.5 A	floating relay contact (changeover contact), contact rating: 24 V/0.1 A	-
Status output (S) ④	-	-	non-isolated 24 V DC output, max. 30 mA
Remote reset input (RST) ④	-	non-isolated 24 V DC input Signal level "High" for > 15 V	non-isolated 24 V DC input Signal level "High" for > 15 V

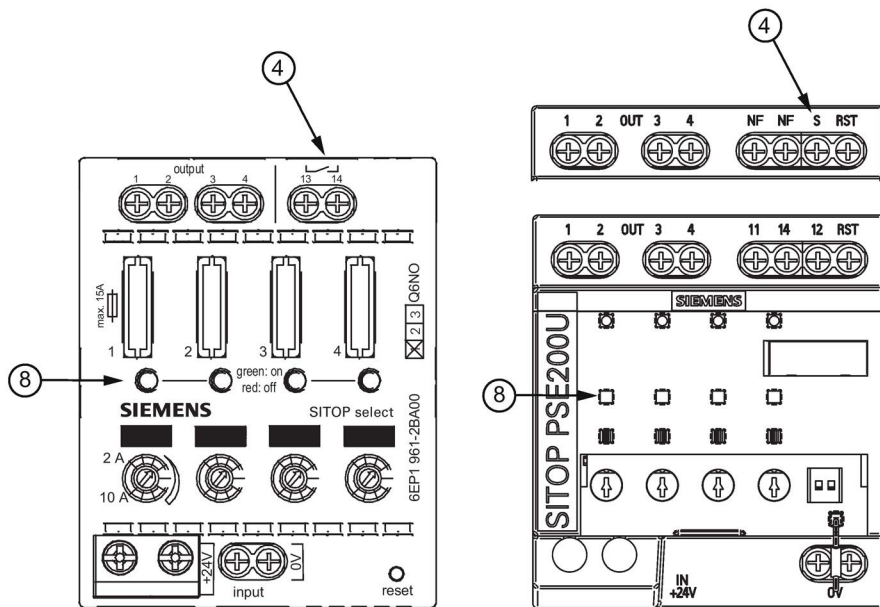

Figure 2-4 Operating displays and signaling (SITOP select and SITOP PSE200U)

The operating state of the outputs is displayed using multi-color LEDs at the front of the device. Symbols indicate the significance of each LED, which are listed in the following table.

○	LED off
●	LED is continuously lit
*	LED flashes

SITOP select

LED ⑧ and group signaling contact ④

Signaling		6EP1961-2BA00
○	Off	All LEDs: <ul style="list-style-type: none"> No supply voltage Device powering up: After the device has powered up, the outputs are switched on, taking into consideration the switch-on delay that has been set.
●	Lights up green	Normal operation, output is switched on
●	Lights up red	Output switched off automatically to due overload
*	Flashes red	Outputs ready to be reset after an automatic switch off by pressing the button
● ● ● ●	Light up red	All LEDs are red (after actuating the reset button for a minimum of 8 s): programming mode for the switch-on delay
* * * *	Flashes red	All LEDs flash red (in the programming mode): signals the programmed switch-on delay time: <ul style="list-style-type: none"> all LEDs flash 1x simultaneously red, followed by a 2 s pause: 0 ms all LEDs flash 2x simultaneously red, followed by a 2 s pause: 24 ms all LEDs flash 3x simultaneously red, followed by a 2 s pause: 100 ms
Group signaling contact (NO contact)		Signal contact (13-14) opens (=quiescent position) when one/several outputs are switched off as a result of overload or when a fuse ruptures.

SITOP PSE200U

LED ⑧ and group signaling contact or status output ④

Signaling		6EP1961-2BA11 6EP1961-2BA21 6EP1961-2BA51	6EP1961-2BA31 6EP1961-2BA41 6EP1961-2BA61
○	Off	All LEDs:	
		<ul style="list-style-type: none"> No supply voltage Device powering up: After the device has powered up, the outputs are switched on, taking into consideration the switch-on delay that has been set. 	
		Group signal: Inactive	Status output ^{1*} : -
		LED, individual output: Output defective (internal fuse has ruptured)	
●	Lights up green	Group signal: Inactive	Status output ^{1*} : Ci = '0'
		Normal operation, output is switched on	
✱	Flash-es green	Group signal: Active	Status output ^{1*} : Ci = '1'
		<p>The output current is in the overload range according to the shutdown characteristic (see Chapter SITOP PSE200U (Page 23))</p> <p>-2BA11, -2BA21, -2BA31, -2BA41: overload at the output: Output current 101 - 150 % of the response threshold (for 5 s)</p> <p>-2BA51, -2BA61: overload at the output: Output current 101 - 110 % of the response threshold (for 5 s)</p>	
●	Lights up red	Group signal: Active	Status output ^{1*} : Ci = '1'
		Output automatically shut down due to overload or external overvoltage > typ. 30 V/100 ms. The output can be switched on again after a typical wait time of 20 s. The wait time still to elapse is saved when switching off the device – and is reactivated after the device has been switched on again.	
✱	Flash-es red	Group signal: Inactive	Status output ^{1*} : Ci = '0'
		Output ready to be reset after an automatic switch off by actuating the button or remote reset (effective for all outputs that have been automatically switched off)	
✱	Flash-es orange	Group signal: Active	Status output ^{1*} : Ci = '0'
		Output manually switched off using the button: The state is saved when the device is switched off, and can only be reset again by pressing the up button again. (Delivery state)	
✱ ○ ○ ○ ➔ ➔ ➔ ➔	Red running light	Group signal: Inactive	Status output ^{1*} : Ci = '0'
		Device overtemperature: The outputs can be switched-on again once the temperature is in the normal range.	
Group signaling contact (changeover contact)		In the "inactive" state, 11-12 are connected and 11-14 open	-

2.4 Status displays and signaling

Signaling	6EP1961-2BA11 6EP1961-2BA21 6EP1961-2BA51	6EP1961-2BA31 6EP1961-2BA41 6EP1961-2BA61
Status output	-	Serial signaling (see Figure 2-5 Status signaling (Page 18)), '1' = 24 V DC / '0' = 0 V (pull down)

* The status of all four outputs is serially signaled using status output ④ (see Figure 2-5 Status signaling (Page 18)). A frame comprises a start bit START and four status bits C_i ($i=1 \dots 4$), which are each separated by a pause bit P. While the device powers up, or if the supply voltage is missing, nothing is signaled, the status remains continuously at '0'. For SIMATIC-S7 controllers (S7-300/400/1200/1500), a function block for evaluation is available under (<http://www.siemens.com/sitop>) or the direct link (<https://support.industry.siemens.com/cs/us/en/view/61450284>).

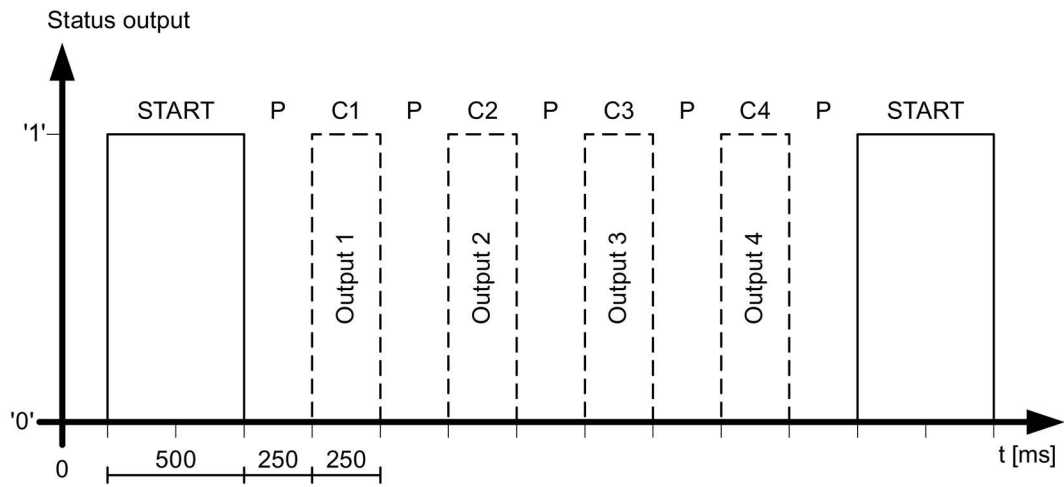

Figure 2-5 Status signaling

2.5 Buttons and selector switches

2.5.1 SITOP select

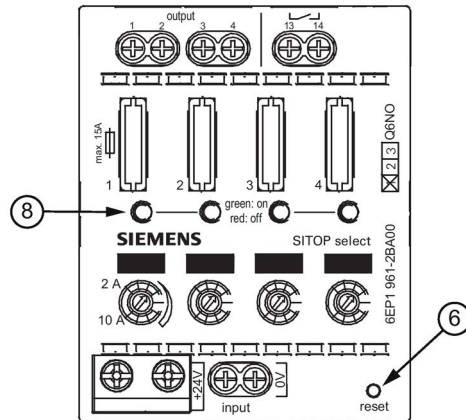

Figure 2-6 Reset button SITOP select

The reset button ⑥ for the SITOP select selectivity module has the following two functions:

1. resets all outputs automatically switched off due to an overload condition (see Chapter Electronic overload shutdown and reset (Page 21)).
2. is used to program the sequential switch-on delay (see Chapter Setting the switch-on delay time (Page 28)).

Note

Switching off and switching on an output while commissioning the device

For selectivity module SITOP select, an output can be manually switched off and switched on, e.g. during commissioning, by removing and inserting the flat fuse of the corresponding output.

2.5.2 SITOP PSE200U

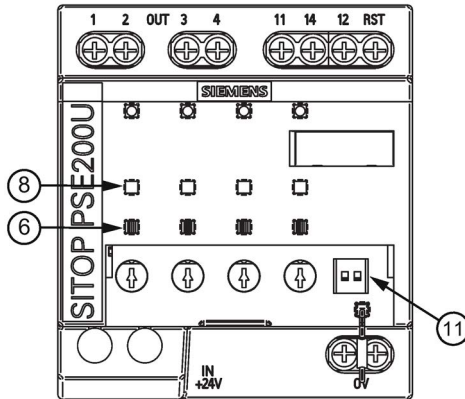

Figure 2-7 Buttons and selector switches, SITOP PSE200U

The button ⑥ for the SITOP PSE200U selectivity module has the following two functions:

1. manually switching an output off and on (see the following).
2. resetting an output automatically switched off due to an overload condition (see Chapter Electronic overload shutdown and reset (Page 21)).

The selector switch ⑪ can be used to select the delay time when switching on the individual outputs (see Chapter Setting the switch-on delay time (Page 28)).

Manually switching an output on and off

An individual output can be switched on and switched off using the button. When the device is delivered, the outputs are manually switched off.

Switching off an output:

For outputs that are switched on, LED ⑧ of the particular output is lit green. You can switch off the output by pressing the assigned button ⑥. The LED then flashes orange (output has been manually switched off).

Switching on an output:

For outputs that have been manually switched off, LED ⑧ of the particular output is lit orange. You can switch on the output by pressing the assigned button ⑥. The LED is then lit green (output is switched on).

Note

An output that has been manually switched-off can only be manually switched-on again by manually pressing the button again. It is not possible to switch on an output that has been manually switched off using the remote reset signal.

An output that has been manually switched off remains saved (latch) even when the supply voltage is no longer available, and is a manually switched off when the supply voltage returns.

2.6 Electronic overload shutdown and reset

An overload is permitted for a defined period of time for each selectivity module output. The output is electronically shut down according to the "Shutdown characteristic" diagram after the limit value has been exceeded.

2.6.1 SITOP select

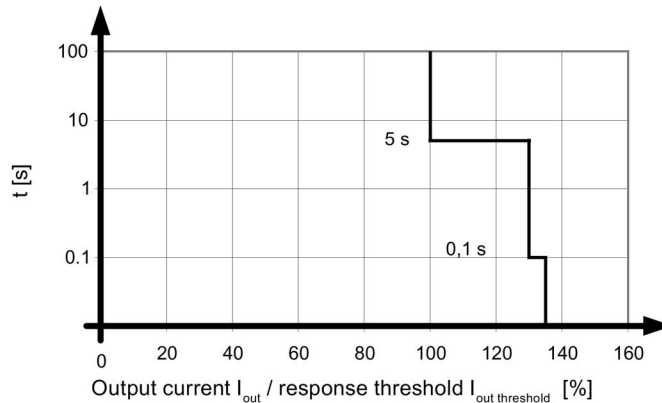

Figure 2-8 Shutdown characteristic SITOP select

- An output current is continuously permissible up to the selected current response threshold (LED of the output is lit green).
- In the range 101 - 129 % of the selected current response threshold, an overload current is permissible for 5 seconds; after this time, the output is electronically shut down (LED of the output is lit red).
- In the range > 130 % of the selected current response threshold, the current is limited to 130 %, after approx. 50 - 100 ms the output is electronically shut down (LED of the output is lit red).
- When the output current exceeds the selected current response threshold, and if the supply voltage simultaneously dips below 20 V, then the output is electronically shutdown (the LED of the output is lit red).

Reset of an electronic overload shutdown using the reset button

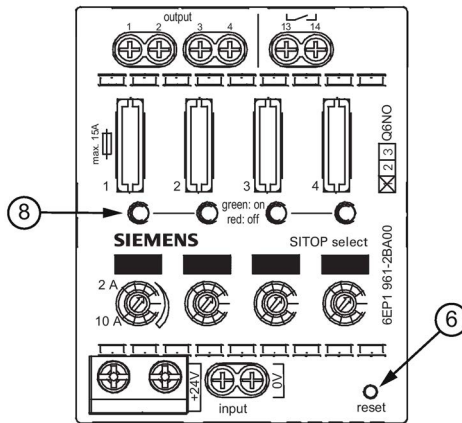

Figure 2-9 Reset button SITOP select

Using the reset button ⑥, after a delay time has elapsed, outputs that have been shut down due to an overload can be reset, i.e. the electronic shutdown can be reset.

The initial situation is an electronic shutdown of individual outputs as a result of an overload condition. This is signaled using the LED ③ of the particular output.

LED	Meaning/handling
Lit red	Electronic shutdown as a result of an overload; wait time until a reset is possible: approx. 20 seconds.
Flashes red	Output ready for a reset; press the button to switch-on the output again.
Lit green	The reset was carried out, the output was switched-on again.

Procedure to reset an electronic shutdown:

1. After an electronic shutdown (LED of the output is lit red), allow a wait time of 20 seconds to elapse.
2. Press the reset button ⑥
Electronic shutdown was reset, and the output has been switched-on again (LED of the output is lit green).

Note

When pressing the button, all of the outputs shut down due to an overload, which are ready for reset (LED flashes red), are switched-in again together.

Note

If, after a reset, the cause of the overload is still present, then the output is again automatically shut down. Before carrying out a reset, remove the cause of the overload to prevent a new shutdown.

2.6.2 SITOP PSE200U

Shutdown characteristics SITOP PSE200U (with the exception of -2BA51, -2BA61) product version 1:

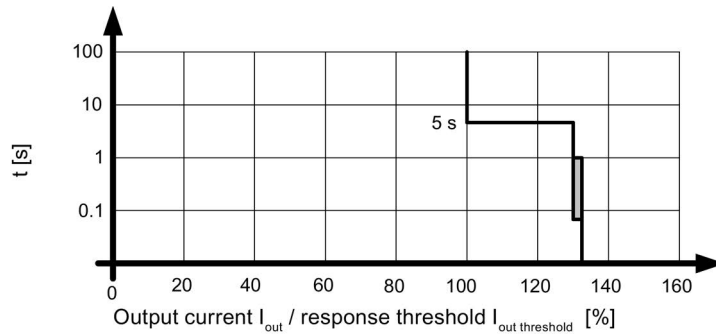

Figure 2-10 Shutdown characteristics SITOP PSE200U (product version 1)

- An output current is continuously permissible up to the selected current response threshold.
- In the range 101 - 129 % of the selected current response threshold, an overload current is permissible for 5 seconds; after this time, the output is electronically shut down.
- In the range > 130 % of the selected current response threshold, the current is limited to 130 %; typically after 100 ms the output is electronically shut down.
- When the output current exceeds the selected current response threshold, and if the supply voltage simultaneously dips below 20 V, then the output is electronically shutdown.

Shutdown characteristic SITOP PSE200U (with the exception of -2BA51, -2BA61) from product version 2 and higher:

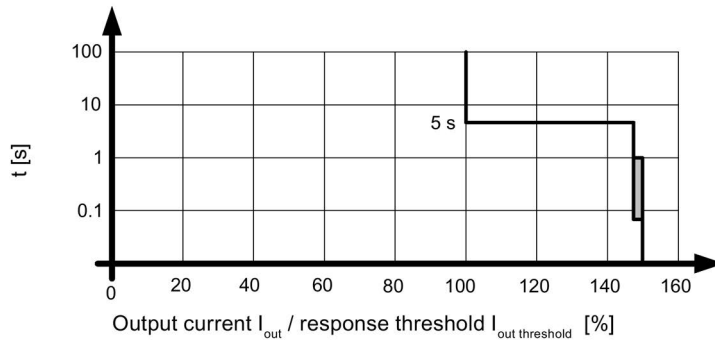

Figure 2-11 Shutdown characteristics SITOP PSE200U (from product version 2 and higher)

- An output current is continuously permissible up to the selected current response threshold (LED of the output is lit green).
- An overload current for 5 seconds is permissible in the range 101 - 149 % of the set current response threshold value (the LED of the output flashes green) - and then the output is electronically shut down (LED of the output is red).
- In the range > 150 % of the selected current response threshold, the current is limited to 150 %, typically after 100 ms, the output is electronically shut down (LED of the output is lit red).
- When the output current exceeds the selected current response threshold, and if the supply voltage simultaneously dips below 20 V, then the output is electronically shutdown (the LED of the output is lit red).

Shutdown characteristic 6EP1961-2BA51, -2BA61:

Figure 2-12 Shutdown characteristic 6EP1961-2BA51, -2BA61

- An output current is continuously permissible up to the selected current response threshold (LED of the output is lit green).
- An overload current for 5 seconds is permissible in the range 101 - 109 % of the set current response threshold value (the LED of the output flashes green) - and then the output is electronically shut down (LED of the output is red).
- In the range > 110 % of the selected current response threshold, the current is limited to 110 %, typically after 100 ms, the output is electronically shut down (LED of the output is lit red).
- When the output current exceeds the selected current response threshold, and if the supply voltage simultaneously dips below 20 V, then the output is electronically shutdown (the LED of the output is lit red).

Reset of an electronic overload shutdown using the reset button and remote reset

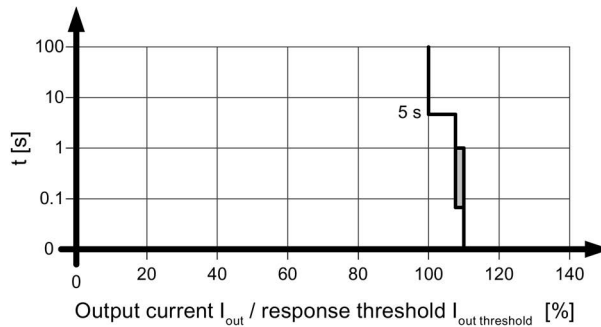
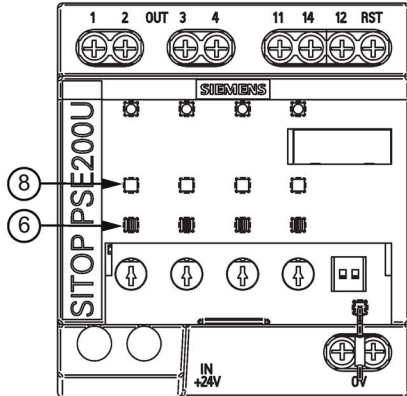

Figure 2-13 SITOP PSE200U button

An individual output can be reset using the button. This resets the electronic shutdown of the output, caused by an overload condition.

The initial situation is an electronic shutdown of individual outputs as a result of an overload condition. This is signaled using the LED ⑧ of the particular output.

LED	Meaning/handling
Lit red	Electronic shutdown as a result of an overload; wait time until a reset is possible: approx. 20 seconds.
Flashes red	Output ready for a reset; press the button to switch-on the output again.
Lit green	The reset was carried out, the output was switched-on again.

Procedure to reset an electronic shutdown:

1. After an electronic shutdown (LED of the output is lit red), allow a wait time of 20 seconds to elapse.
2. Press the reset button ⑥ of the particular output
Electronic shutdown was reset, and the output has been switched-on again (LED of the output is lit green).

Remote reset:

Alternatively, a remote reset signal can be used. The non-isolated 24 V input (referred to the "0 V" terminal of the module) can be used at terminal "RST". A reset is executed for an input level of > 15 V.

Note

The rising edge of the remote reset signal is evaluated, i.e. for an additional remote reset signal, initially a voltage level of 13 V must be fallen below.

Using a remote reset signal at terminal "RST" all outputs that were shut down electronically due to an overload are reset at this time. Prerequisite: The output is ready to be reset, i.e. the electronic overload shutdown occurred longer than 20 s ago (LED of the output flashes red).

Note

If, after a reset, the cause of the overload is still present, then the output is again automatically shut down. Before carrying out a reset, remove the cause of the overload to prevent a new shutdown.

2.7 Setting the switch-on delay time

For specific loads, it can make sense to sequentially switch-on the outputs in order to reduce the peak inrush currents, and therefore the load on the power supply. To achieve this, the individual outputs of the selectivity module can be switched-in with a time delay between one another in a fixed sequence (output 1 → 2 → 3 → 4). The delay time set between the individual outputs is the same for all of the outputs. When supplied, the delay time is set to 0 ms (all outputs switch on simultaneously).

2.7.1 SITOP select

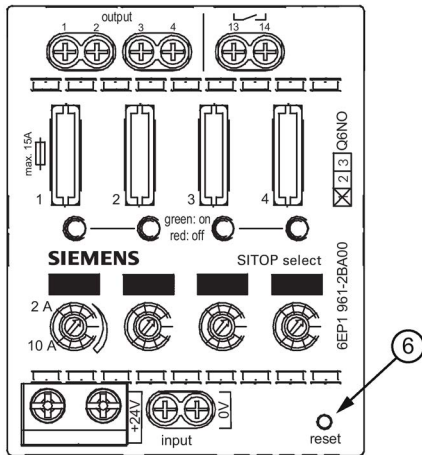

Figure 2-14 Reset button SITOP select

Programming the sequential switch-on delay

For specific loads, it can make sense to sequentially switch-on the outputs in order to reduce the peak inrush currents, and therefore the load on the power supply. To achieve this, the individual outputs of the selectivity module can be switched-in with a time delay between one another in a fixed sequence (output 1 → 2 → 3 → 4). The delay time between the individual outputs is the same for all outputs, and can be set to 0 ms, 24 ms or 100 ms. The selected setting is also kept for an unlimited time even when the power fails, and can be changed as often as required. When supplied, the delay time is set to 0 ms (all outputs switch on simultaneously).

Procedure when setting the delay time:

1. Keep the reset button ⑥ pressed for approximately 8 seconds. The selectivity module changes into the programming mode, all LEDs are lit red and the outputs are shut down.
2. Release the reset button. The LEDs signal the selected delay time using a specific flash rhythm. The meaning is as follows:

LED	Meaning
flash 1x simultaneously red, followed by a 2 s pause	Delay time of 0 ms selected
flash 2x simultaneously red, followed by a 2 s pause	Delay time of 24 ms selected
flash 3x simultaneously red, followed by a 2 s pause	Delay time of 100 ms selected

The flashing rhythm is repeated after a pause of approx. 2 s.

3. Briefly press the reset button; this causes the actual setting to be moved forward by one stage (0 ms \Rightarrow 24 ms \Rightarrow 100 ms \Rightarrow 0 ms). Press the reset button several times until the required setting is signaled.
4. Then keep the reset button pressed for approximately 8 seconds. All LEDs light up red.
5. Release the reset button. The selectivity module saves the delay time that has been set and sequentially switches on the outputs.

The LEDs of the outputs are lit green, and the selectivity module is again in its normal operating mode.

Note

In the programming mode, if the reset button is not pressed within 30 s, then the selectivity module automatically returns to the normal operating state without saving any change made to the delay time. The setting is also not saved if, while programming, the supply voltage fails.

Note

The selectivity module outputs are shut down while programming, and are automatically switched-on again after the programming mode is either manually or automatically exited. They are also automatically switched on again after the voltage returns after a power failure!

2.7.2 SITOP PSE200U

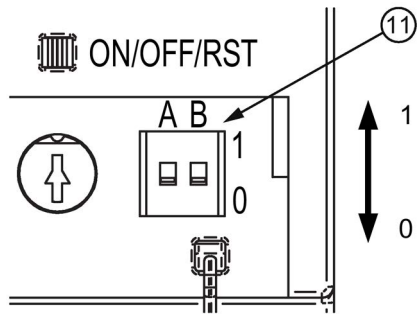

Figure 2-15 SITOP PSE200U selector switch

Setting the sequential switch-on delay

The switch-on delay is set at selector switch ⑪. When delivered, DIP switches "A" and "B" are in position "0" (no switch-on delay).

Procedure when setting the delay time:

With the selectivity module in a no-voltage condition, set DIP switches "A" and "B" to the required delay time.

	No delay, all four outputs are simultaneously switched-on (condition when delivered).
	25 ms delay between the outputs being switched on.
	100 ms delay between the outputs being switched on.
	Outputs switched on depending on the load: The next output is switched on as soon as the current of the previous output lies below the selected response threshold.

The next time that the selectivity module powers up, the outputs are sequentially switched on corresponding to the selected delay time.

2.8 Block diagram

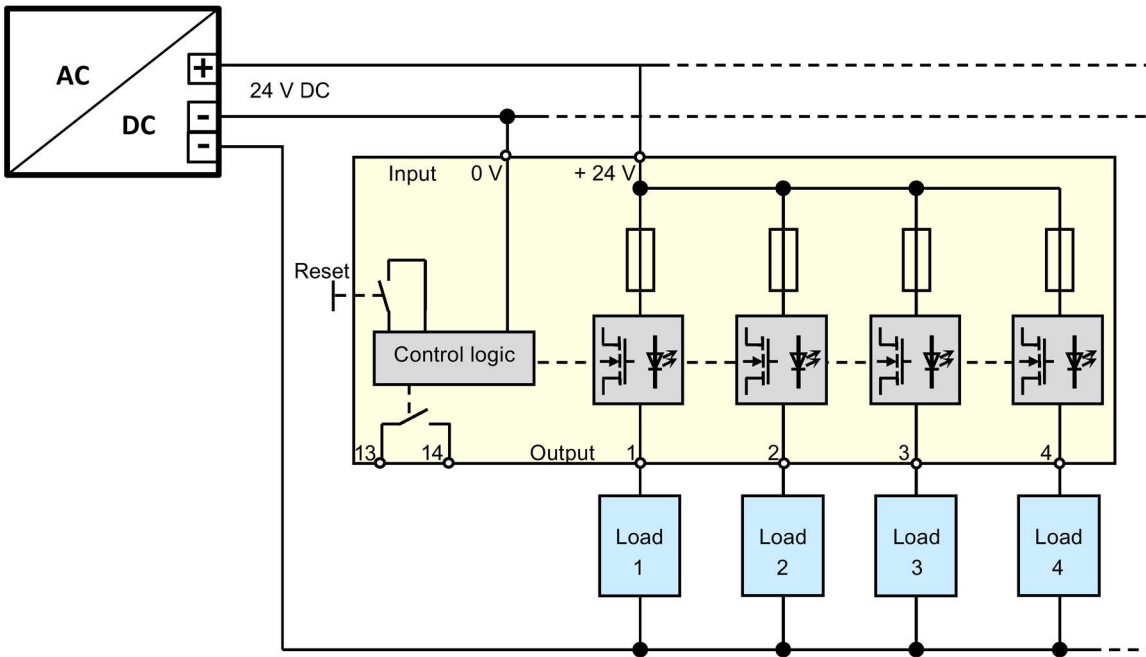

Figure 2-16 Block diagram of the 6EP1961-2BA00

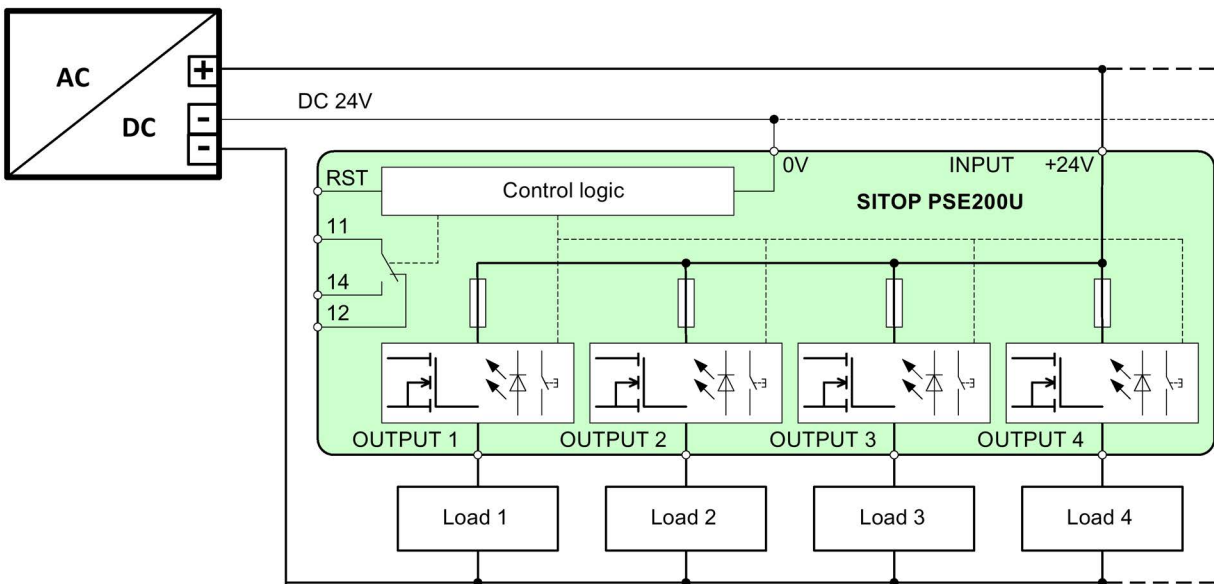

Figure 2-17 Block diagram for 6EP1961-2BA11, 6EP1961-2BA21 and 6EP1961-2BA51

2.8 Block diagram

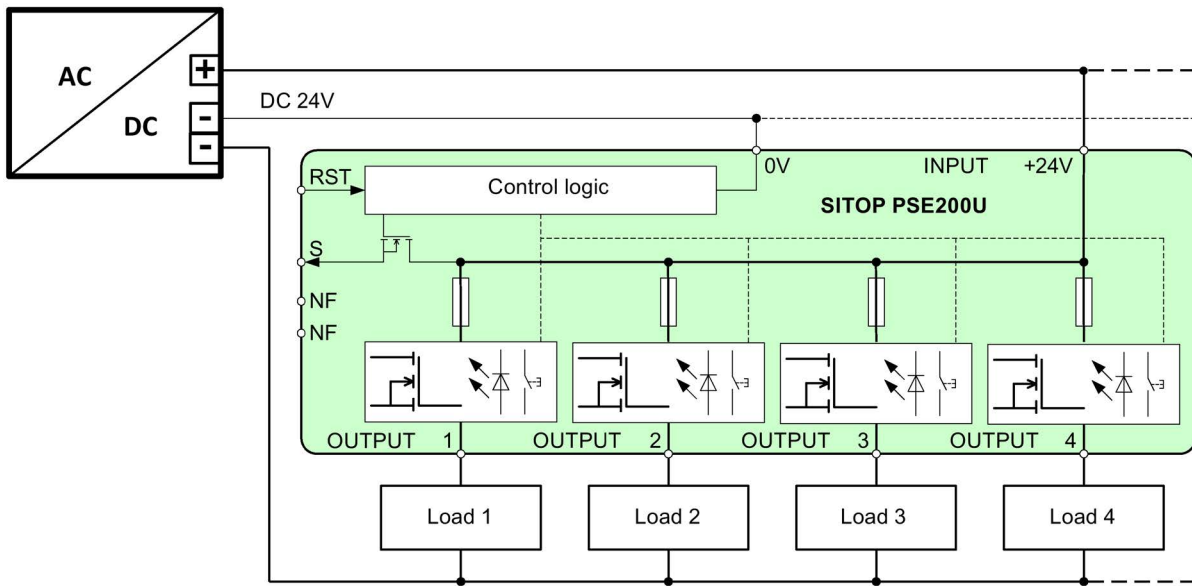

Figure 2-18 Block diagram 6EP1961-2BA31, 6EP1961-2BA41 and 6EP1961-2BA61

2.9 Dimensions and weight

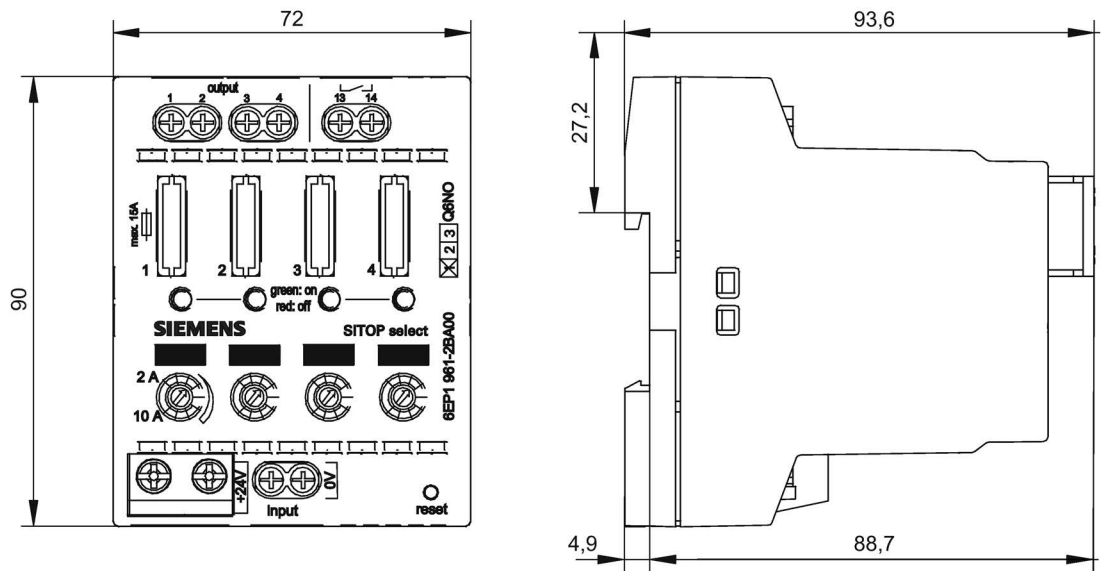

Figure 2-19 Dimension drawing 6EP1961-2BA00

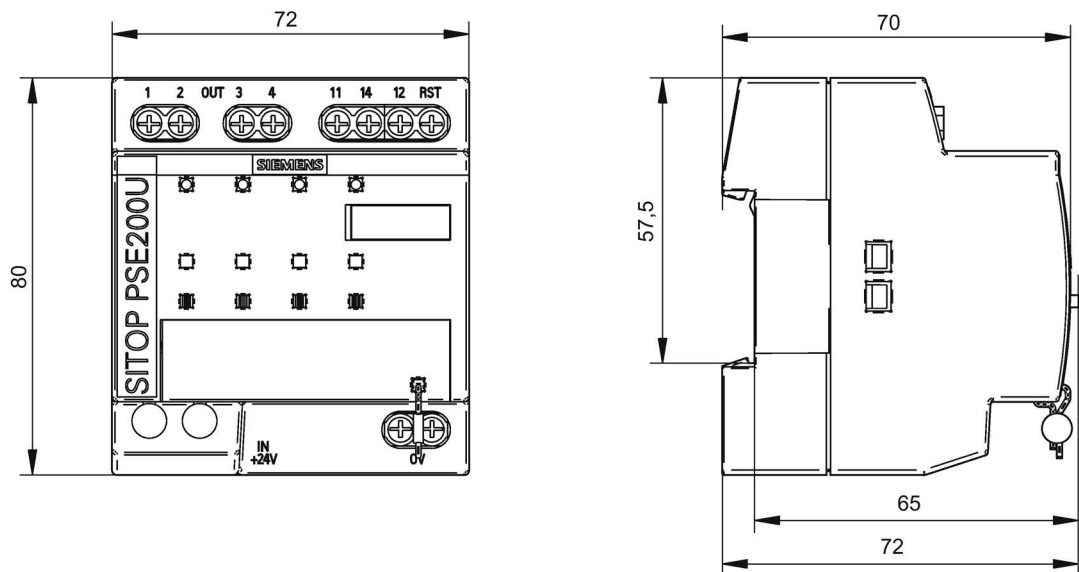

Figure 2-20 Dimension drawing 6EP1961-2BA*1

2.9 Dimensions and weight

	6EP1961-2BA00	6EP1961-2BA11 6EP1961-2BA31 6EP1961-2BA21 6EP1961-2BA41 6EP1961-2BA51 6EP1961-2BA61
Dimensions (W × H × D) in mm	72 × 90 × 88.7	72 × 80 × 65
Weight	Approx. 0.4 kg	Approx. 0.2 kg

Mounting/removal

<p>! WARNING</p> <p>Installing the device in a housing or a control cabinet</p> <p>The SITOP select and SITOP PSE200U selectivity modules are built-in units. They must be installed in a housing or control cabinet where only qualified personnel have access.</p>
--

The device can be mounted in a control cabinet on standard mounting rails (see Chapter Mechanical system (Page 56))

Mounting

To mount the device, position it with the mounting rail guide at the upper edge of the standard mounting rail and press down to lock it into place. If it is too difficult to snap them into place, press slider ① at the same time, as described under "Removal".

Removal

To remove the device, pull slider ① using a screwdriver ② (see Figure 3-1 Mounting/removal (example: 6EP1961-2BA11) (Page 35)) and detach it at the lower edge of the standard mounting rail. Then you can remove the device from the upper edge of the standard mounting rail.

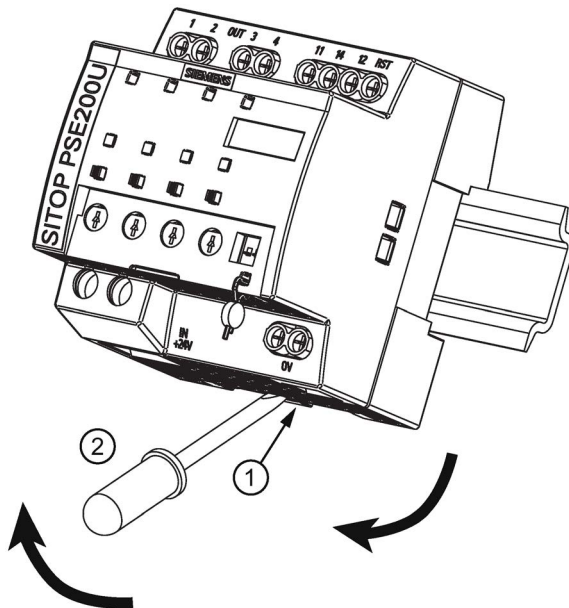

Figure 3-1 Mounting/removal (example: 6EP1961-2BA11)

 **WARNING**

Use in hazardous zones

If the device is installed in a hazardous zone (II 3G Ex nA nC IIC T4 Gc (6EP1961-2BA00, -2BA11, -2BA21, -2BA51) / II 3G Ex nA IIC T4 Gc (-2BA31, -2BA41, -2BA61)), then it must be installed in a distribution box with degree of protection IP54 or higher. This distribution box must comply with the requirements of EN 60079-15 and must require a tool for opening.

Mounting position, mounting clearances

4.1 Standard mounting position

The device is mounted on standard mounting rails. The device must be mounted vertically in such a way that the input terminals are at the bottom.

A clearance of at least 50 mm should be maintained above and below the device (maximum depth of the cable duct, 50 mm).

No space is required at the side.

Individual output current as a function of the ambient temperature and installation altitude

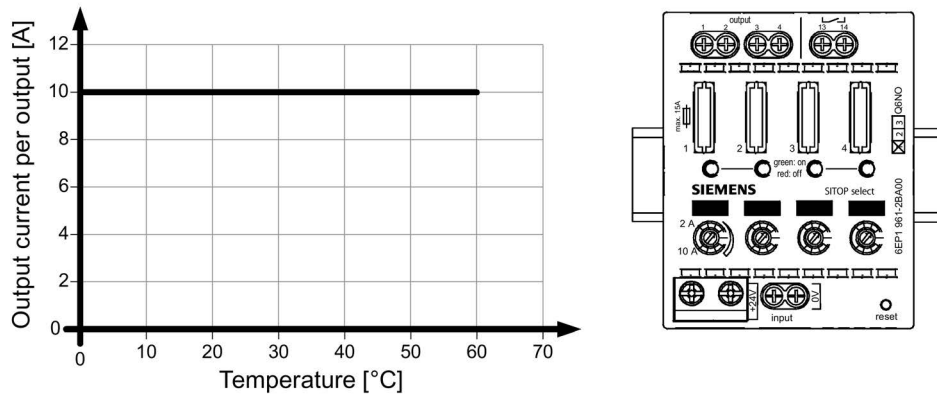

Figure 4-1 6EP1961-2BA00: Output current in the standard mounting position

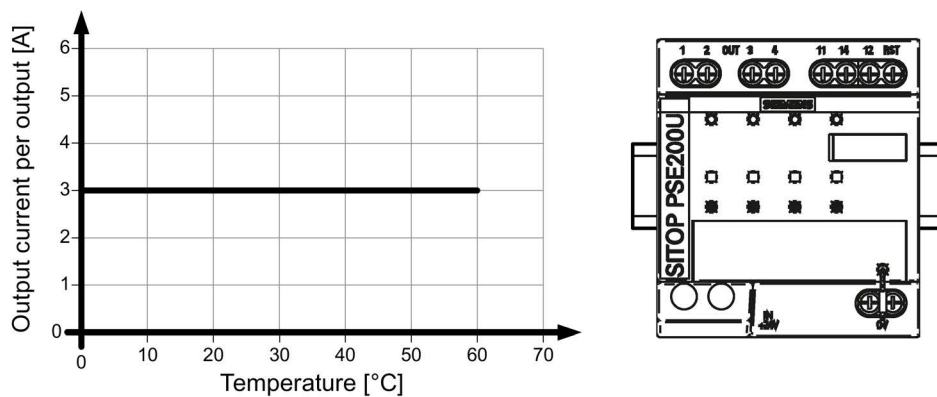

Figure 4-2 6EP1961-2BA11, 6EP1961-2BA31, 6EP1961-2BA51 and 6EP1961-2BA61 output current in the standard mounting position

4.1 Standard mounting position

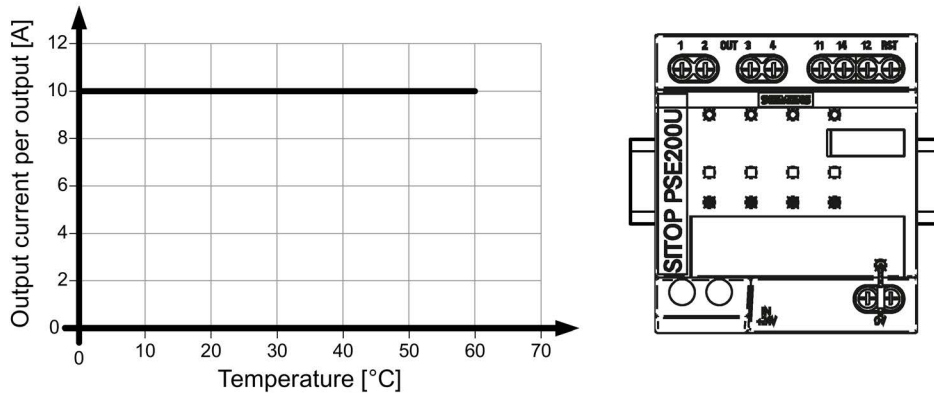

Figure 4-3 6EP1961-2BA21 and 6EP1961-2BA41: Output current in the standard mounting position

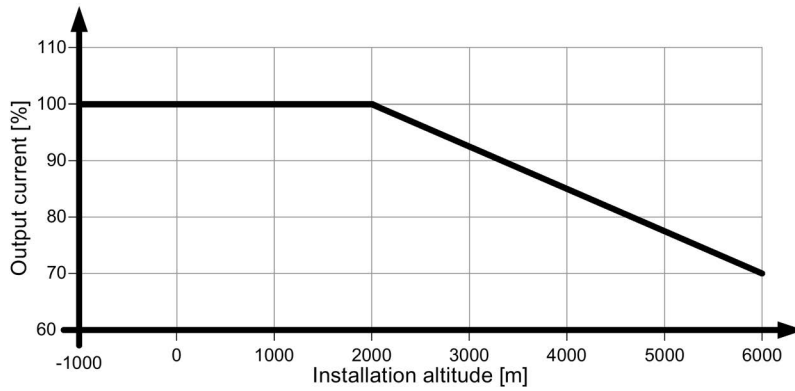

Figure 4-4 Mounting height derating

4.2 Other mounting positions

For mounting positions that deviate from the standard mounting position, derating factors (reduction of the output power or the permissible ambient temperature) must be observed in accordance with the following diagrams.

Note

In the case of mounting positions that deviate from the standard mounting position, reduced mechanical resistance of the devices against vibration and shock must be expected.

Particularly when installing on a vertically fastened standard mounting rail, additional measures may be required, e.g. to prevent the device from slipping on the standard mounting rail.

4.2.1 6EP1961-2BA00

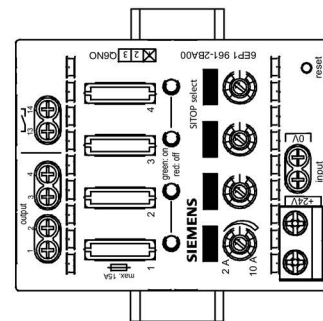
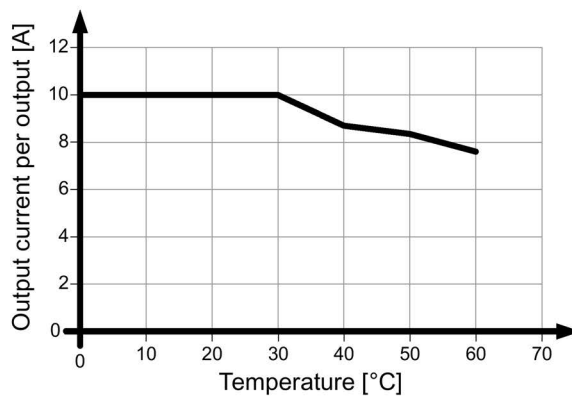

Figure 4-5 Mounting position (1)

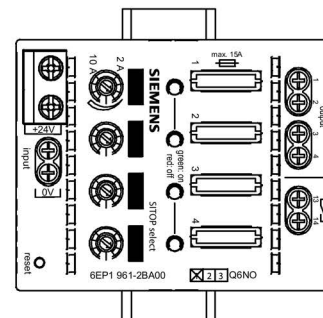
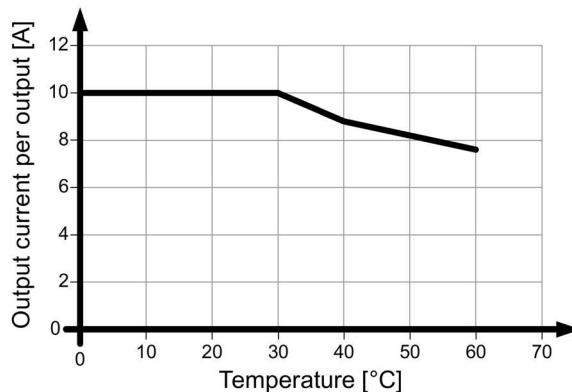

Figure 4-6 Mounting position (2)

4.2 Other mounting positions

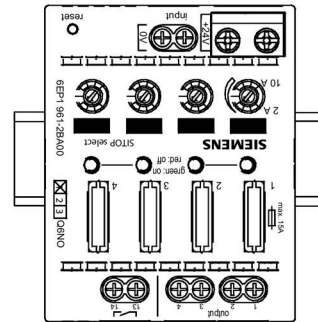
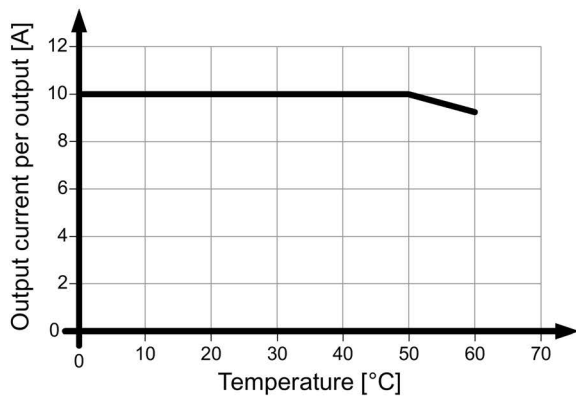

Figure 4-7 Mounting position (3)

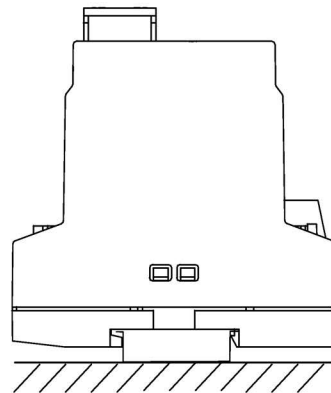
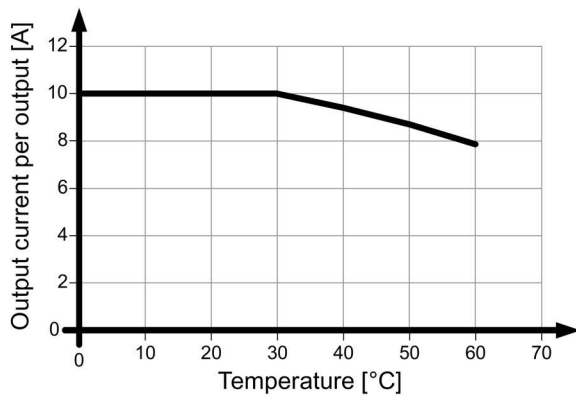

Figure 4-8 Mounting position (4)

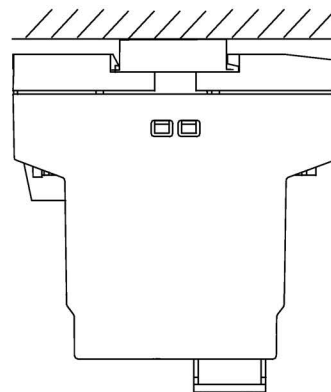
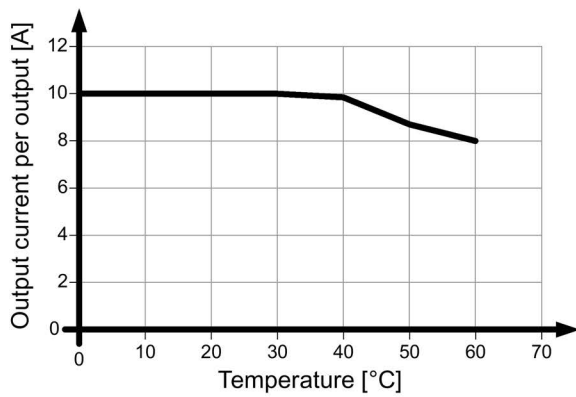

Figure 4-9 Mounting position (5)

4.2.2 6EP1961-2BA11, 6EP1961-2BA31, 6EP1961-2BA51 and 6EP1961-2BA61

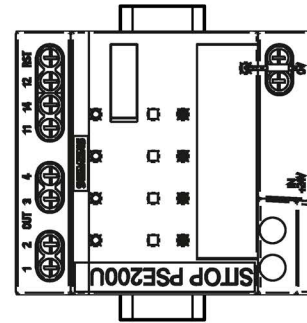
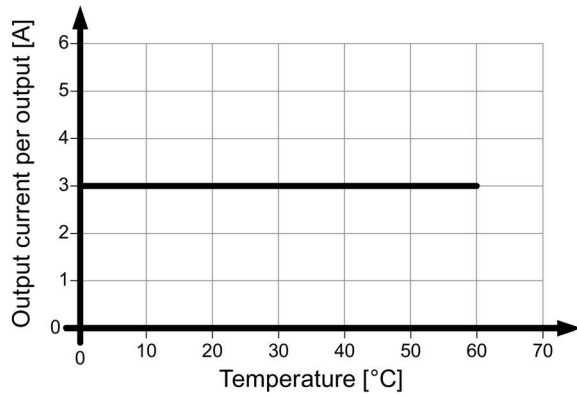

Figure 4-10 Mounting position (1)

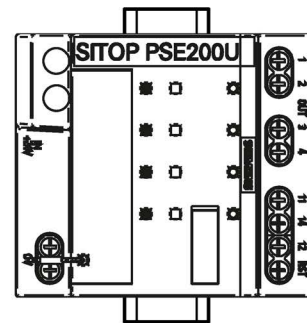
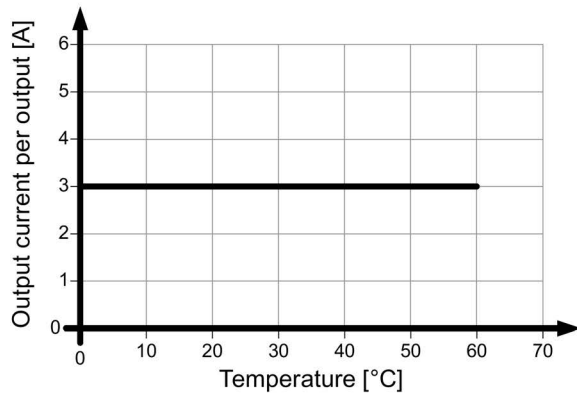

Figure 4-11 Mounting position (2)

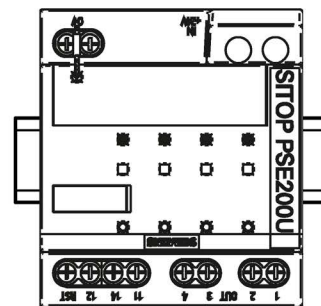
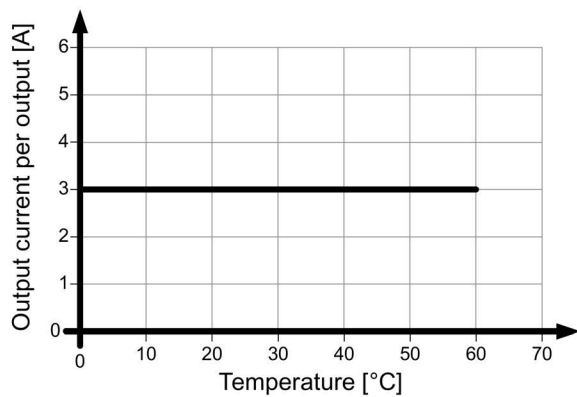

Figure 4-12 Mounting position (3)

4.2 Other mounting positions

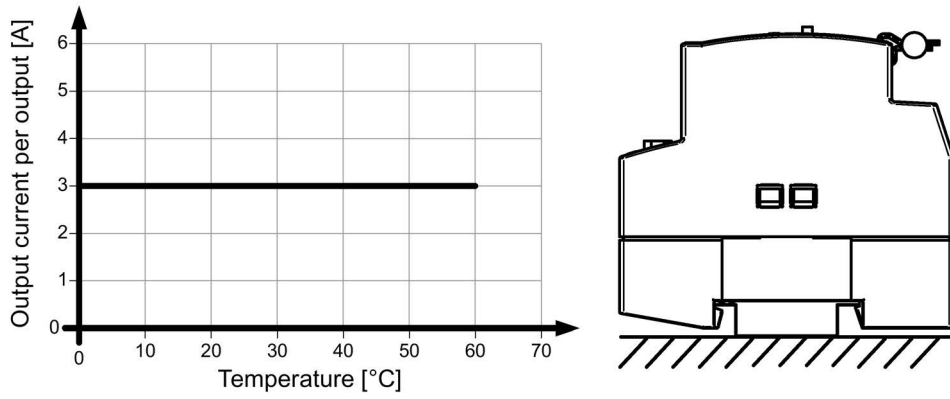

Figure 4-13 Mounting position (4)

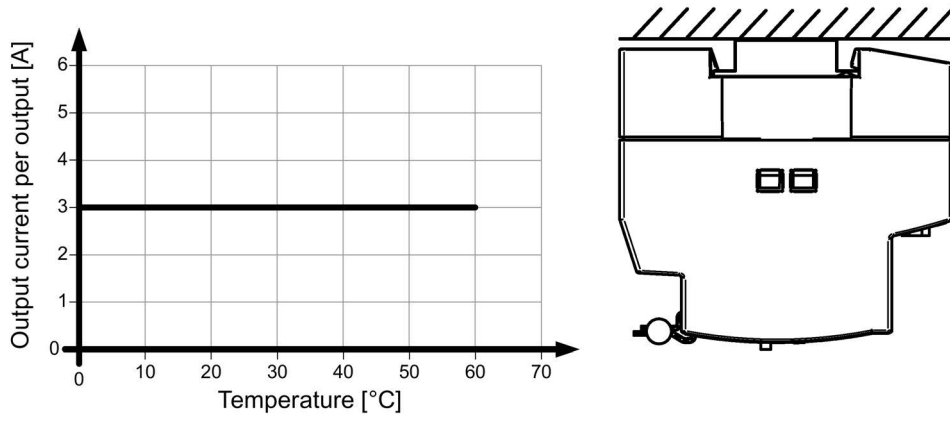

Figure 4-14 Mounting position (5)

4.2.3 6EP1961-2BA21 and 6EP1961-2BA41

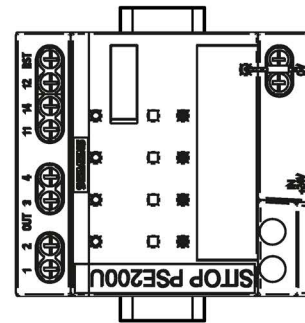
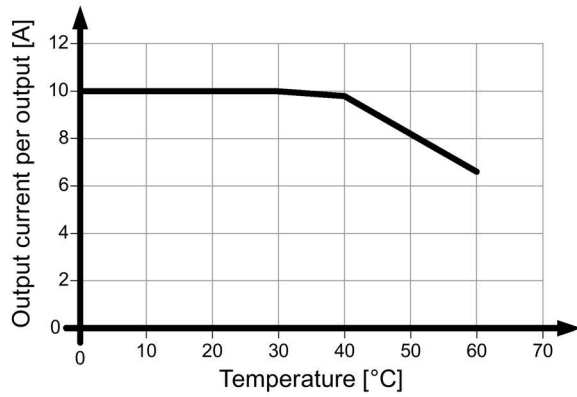

Figure 4-15 Mounting position (1)

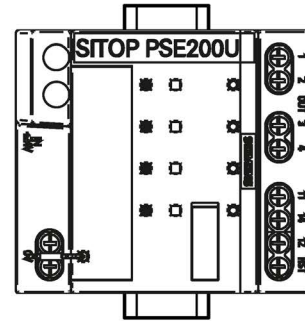
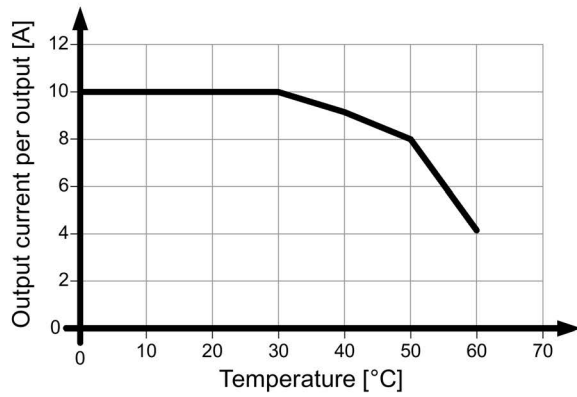

Figure 4-16 Mounting position (2)

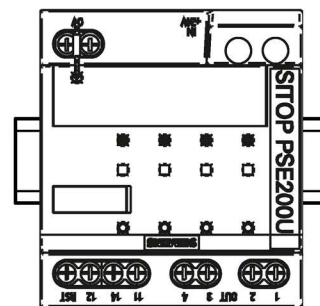
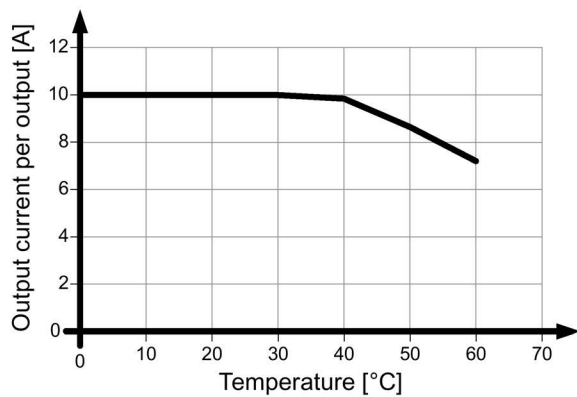

Figure 4-17 Mounting position (3)

4.2 Other mounting positions

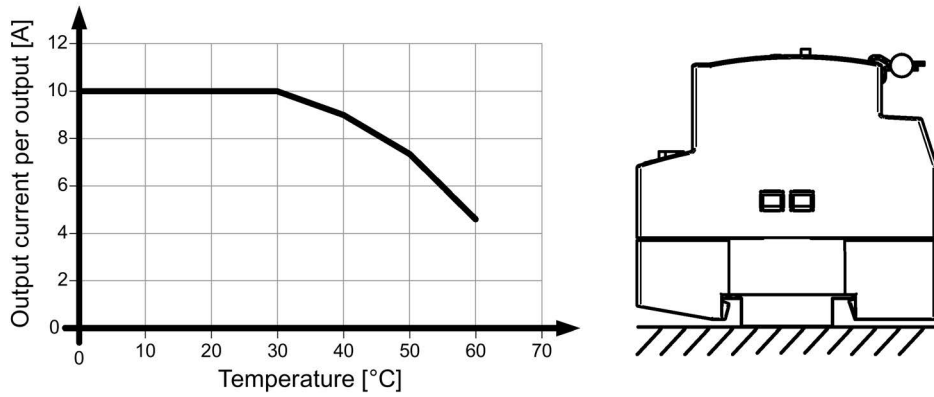

Figure 4-18 Mounting position (4)

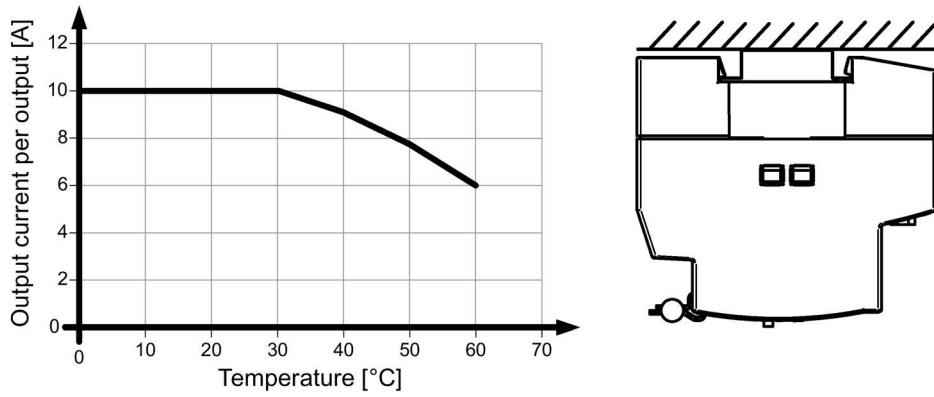



Figure 4-19 Mounting position (5)

 WARNING
Hazard due to electric shock
Before installation or maintenance work can begin, the system's main switch must be switched off and measures taken to prevent it being switched on again. If this instruction is not observed, touching live parts can result in death or serious injury.

5.1 Input side connection

 WARNING
The device is only suitable for operation with 24 V DC voltages (safety extra low voltage). If this device is connected to line supplies with higher voltage levels this can result in death or serious injury as well as extensive material damage.
Only appropriately qualified personnel may work on or in the vicinity of this equipment. Perfect, safe, and reliable operation of this equipment is dependent on proper transportation, storage, installation and mounting.

5.1 Input side connection

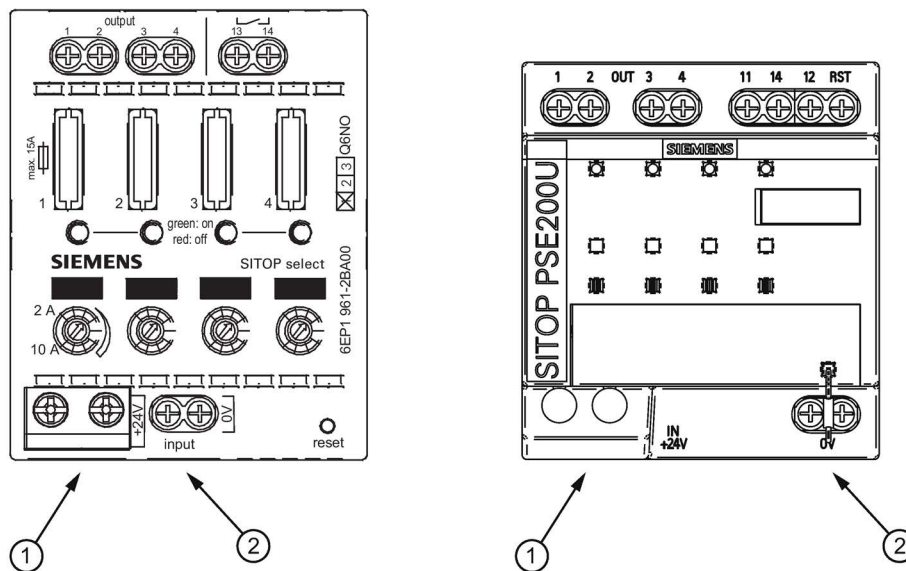

Figure 5-1 Input connection

The supply is connected via input terminal ①, designated "24 V" and the 0 V terminal ②, designated "0 V"; the "0 V" connection is not used for the load supply, but only to supply the internal electronics of the selectivity module (terminal cross-sections, see Figure 2-2 Terminal data (Page 13)).

NOTICE

Overload of the wiring

The "0 V" connection is only used to supply the internal electronics of the selectivity module. The 0 V of the connected loads must be routed directly to the power supply using separate cables!

NOTICE

Overload of the wiring

The input terminals of the selectivity module are designed for a maximum input current of 40 A. This must be taken into account when connecting several selectivity modules in parallel using "loop through". If the total current demand of all selectivity modules connected in parallel is more than 40 A, then the maximum current should be reduced to 40 A per branch by using additional feeder cables directly from the power supply to the selectivity modules connected in parallel.

5.2 Output-side connection

(see Chapter Technical data (Page 49))

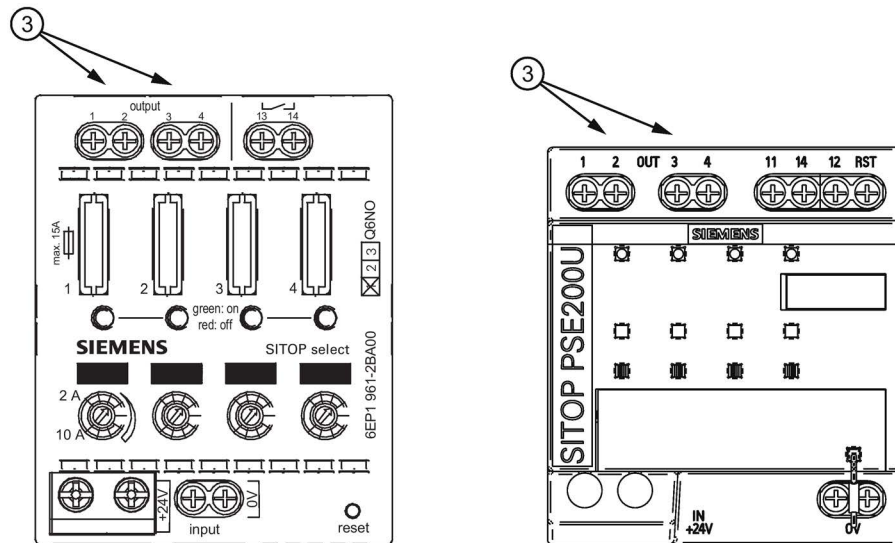

Figure 5-2 Output connection

The loads to be supplied are connected through output terminals ③ labeled OUT 1, 2, 3, 4. (terminal cross-sections, see Figure Terminal data (Page 13)).

Note

The 0 V of the loads must be routed directly to the power supply using separate cables!

When delivered, the status of all channels is "Output switched off manually" ⇒ Press the button to switch-on the particular output (see Chapter SITOP PSE200U (Page 20))

Technical data

Note

Technical data apply for a rated input voltage, rated load and 25 °C ambient temperature if nothing else is specified.

6.1 Input

	6EP1961-2BA00	6EP1961-2BA11 6EP1961-2BA31 6EP1961-2BA51 6EP1961-2BA61	6EP1961-2BA21 6EP1961-2BA41
Input	Regulated DC voltage ^{1*)}	Regulated DC voltage	Regulated DC voltage
Rated voltage $U_{in \text{ rated}}$	24 V	24 V	24 V
Voltage range	22 - 30 V	22 - 30 V	22 - 30 V
Overvoltage strength	35 V; 100 ms	35 V	35 V
Input current at $U_{in \text{ rated}}$	40 A	12 A	40 A

^{1*)} SITOP select (6EP1961-2BA00) cannot be operated with the DC-UPS module 40 A (6EP1931-2FC21/-2FC42).

6.2 Output

	6EP1961-2BA00	6EP1961-2BA11 6EP1961-2BA31 6EP1961-2BA51 6EP1961-2BA61	6EP1961-2BA21 6EP1961-2BA41
Output	Regulated DC voltage	Regulated DC voltage	Regulated DC voltage
Output voltage	U_{in} - approx. 0.3 V	U_{in} - approx. 0.2 V	U_{in} - approx. 0.2 V
Total tolerance	Corresponding to the supplying input voltage	Corresponding to the supplying input voltage	Corresponding to the supplying input voltage
Number of outputs	4	4	4
Output current up to 60 °C for each output (rated value)	10 A	3 A	10 A
Adjustable response threshold	2 - 10 A	0.5 - 3 A	3 - 10 A
Connecting outputs in parallel	No	No	No
Residual current at shutdown (typ.)	20 mA	< 1 mA	< 1 mA
Switching on outputs	All outputs are simultaneously switch on after the supply voltage has ramped up, delay time of 24 ms or 100 ms can be programmed for outputs to be sequentially switched on.	All outputs are simultaneously switched-on after the supply voltage ramps up > 20 V, delay time of 25 ms, 100 ms – or "load optimized" where the outputs are sequentially switched-on, selected using the DIP switch.	

Shutdown characteristics SITOP select:

Figure 6-1 Shutdown characteristic SITOP select

- An output current is continuously permissible up to the selected current response threshold.
- In the range 101 - 129 % of the selected current response threshold, an overload current is permissible for 5 seconds; after this time, the output is electronically shut down.
- In the range > 130 % of the selected current response threshold, the current is limited to 130 %; after approximately 50 - 100 ms, the output is electronically shut down.
- When the output current exceeds the selected current response threshold, and if the supply voltage simultaneously dips below 20 V, then the output is electronically shutdown.

Shutdown characteristics SITOP PSE200U (with the exception of -2BA51, -2BA61) product version 1:

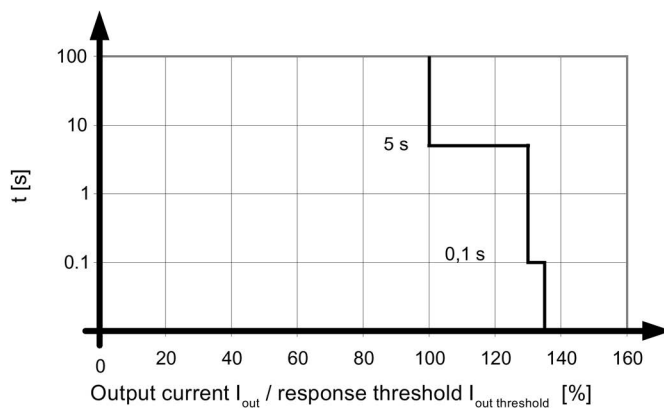
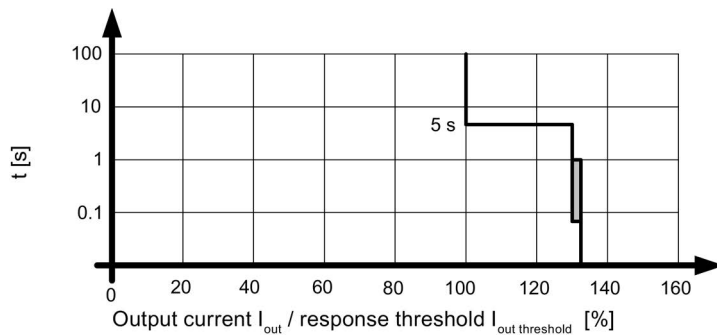

Figure 6-2 Shutdown characteristics SITOP PSE200U (product version 1)

- An output current is continuously permissible up to the selected current response threshold.
- In the range 101 - 129 % of the selected current response threshold, an overload current is permissible for 5 seconds; after this time, the output is electronically shut down.
- In the range > 130 % of the selected current response threshold, the current is limited to 130 %; typically after 100 ms the output is electronically shut down.
- When the output current exceeds the selected current response threshold, and if the supply voltage simultaneously dips below 20 V, then the output is electronically shutdown.

Shutdown characteristics SITOP PSE200U (with the exception of -2BA51, -2BA61) from product version 2 and higher:

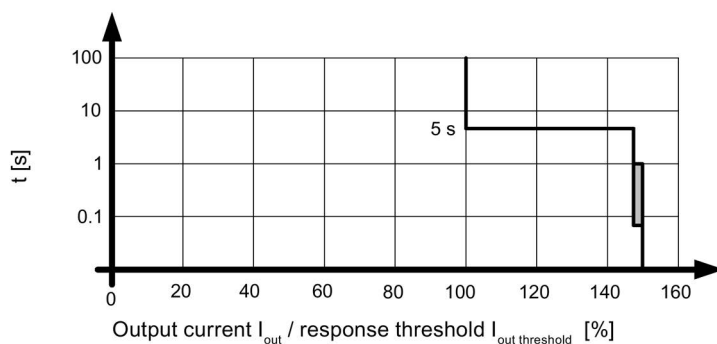

Figure 6-3 Shutdown characteristics SITOP PSE200U (from product version 2 and higher)

- An output current is continuously permissible up to the selected current response threshold.
- In the range 101 - 149 % of the selected current response threshold, an overload current is permissible for 5 seconds; after this time, the output is electronically shut down.
- In the range > 150 % of the selected current response threshold, the current is limited to 150 %; typically after 100 ms the output is electronically shut down.
- When the output current exceeds the selected current response threshold, and if the supply voltage simultaneously dips below 20 V, then the output is electronically shutdown.

Shutdown characteristic 6EP1961-2BA51, -2BA61:

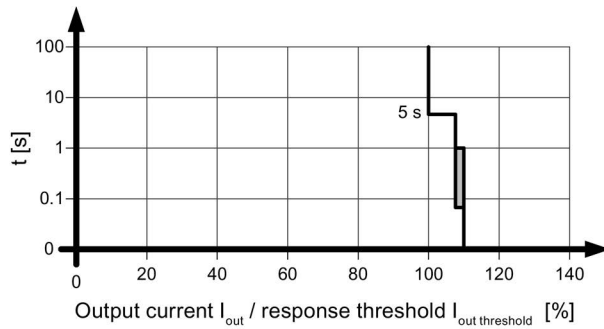

Figure 6-4 Shutdown characteristic 6EP1961-2BA51, -2BA61

- An output current is continuously permissible up to the selected current response threshold (LED of the output is lit green).
- In the range 101 - 109 % of the selected current response threshold, an overload current is permissible for 5 seconds (LED of the output flashes green), then the output is electronically shut down (LED of the output is lit red).
- In the range > 110 % of the selected current response threshold, the current is limited to 110 %, typically after 100 ms, the output is electronically shut down (LED of the output is lit red).
- When the output current exceeds the selected current response threshold, and if the supply voltage simultaneously dips below 20 V, then the output is electronically shutdown (the LED of the output is lit red).

6.3 Efficiency

	6EP1961-2BA00	6EP1961-2BA11 6EP1961-2BA31 6EP1961-2BA51 6EP1961-2BA61	6EP1961-2BA21 6EP1961-2BA41
Efficiency at $U_{out rated}$, $I_{out rated}$, approx.	97 %	97 %	99 %
Power loss at $U_{out rated}$, $I_{out rated}$, approx.	30 W	9 W	10 W

6.4 Protection and monitoring

	6EP1961-2BA00	6EP1961-2BA11 6EP1961-2BA51	6EP1961-2BA21	6EP1961-2BA31 6EP1961-2BA61	6EP1961-2BA41
Device protection	Flat fuse for each output (a 15 A fuse is inserted when the device is shipped) ¹⁾	Internal fuse 5 A for each output (not accessible)	Internal fuse 15 A for each output (not accessible)	Internal fuse 5 A for each output (not accessible)	Internal fuse 15 A for each output (not accessible)
Operating display	One LED per output: Green LED for "Output switched through", red LED for "Output shutdown due to overcurrent"	One LED per output: Green LED for "Output switched through", orange LED for "Output manually switched off", red LED for "Output shutdown due to overcurrent".			
Signaling	Group signaling contact (NO contact, contact rating 0.5 A/24 V)	Group signaling contact (changeover contact, contact rating 0.1 A/24 V)		Status signal output (pulse position signal that can be evaluated using a Simatic function block)	

¹⁾ Note for 6EP1961-2BA00:

When required, depending on the potentiometer setting, lower fuse values can be selected.

Setting to → fuse from

2 A → 3 A

3 A → 4 A

4 A → 5 A

6 A → 7.5 A

8 A → 10 A

10 A → 15 A

6.5 MTBF

	6EP1961-2BA00	6EP1961-2BA31	6EP1961-2BA51
	6EP1961-2BA11	6EP1961-2BA41	6EP1961-2BA61
	6EP1961-2BA21		
Mean Time Between Failures	> 500,000 hours at 40 °C, rated load, 24 hour operation		

6.6 Mechanical system

	6EP1961-2BA00	6EP1961-2BA11	6EP1961-2BA31
		6EP1961-2BA21	6EP1961-2BA41
		6EP1961-2BA51	6EP1961-2BA61
Connection system	Screw connection	Screw connection	Screw connection
+24 V input	2 screw terminals for 0.5 - 16 mm ²	2 screw terminals for 0.5 - 16 mm ²	2 screw terminals for 0.5 - 16 mm ²
0 V connection	2 screw terminals for 0.2 - 6 (4) mm ² solid (finely stranded)	2 screw terminals for 0.2 - 6 (4) mm ² solid (finely stranded)	2 screw terminals for 0.2 - 6 (4) mm ² solid (finely stranded)
Output 1, 2, 3, 4	One screw-type terminal for each output for 0.2 - 6 (4) mm ² solid (finely stranded)	One screw-type terminal for each output for 0.2 - 6 (4) mm ² solid (finely stranded)	One screw-type terminal for each output for 0.2 - 6 (4) mm ² solid (finely stranded)
Group signal contact	2 screw terminals for 0.2 - 6 (4) mm ² solid (finely stranded)	3 screw terminals for 0.2 - 6 (4) mm ² solid (finely stranded)	-
Status output	-	-	One screw terminal for 0.2 - 6 (4) mm ² solid (finely stranded)
Remote reset	-	One screw terminal for 0.2 - 6 (4) mm ² solid (finely stranded)	One screw terminal for 0.2 - 6 (4) mm ² solid (finely stranded)
Width of the housing	72 mm	72 mm	72 mm
Height of the housing	90 mm	80 mm	80 mm
Depth of the housing	approx. 90 mm	72 mm	72 mm
Installation width	72 mm	72 mm	72 mm
Mounting height	190 mm	180 mm	180 mm
Weight, approx.	0.4 kg	0.2 kg	0.2 kg
Mounting	Can be snapped onto standard TH35-15/7,5 mounting rails (EN 60715)		

6.7 Accessories

Accessories

	6EP1961-2BA00	6EP1961-2BA11 6EP1961-2BA21 6EP1961-2BA31 6EP1961-2BA41 6EP1961-2BA51 6EP1961-2BA61
Electrical accessories	Flat insertable fuse: Manufacturer, Littelfuse, series FKS or PXS, 19 mm long	-
Mechanical accessories	-	Device name plate 20 mm x 7 mm TI grey 3RT2900-1SB20

6.8 Dimension drawing

See chapter Dimensions and weight (Page 33)

CAD data that can be downloaded from the Internet:

6EP1961-2BA00

(http://www.automation.siemens.com/bilddb/index.aspx?objKey=G_KT01_XX_00575)

6EP1961-2BA11

(http://www.automation.siemens.com/bilddb/index.aspx?objKey=G_KT01_XX_00423)

6EP1961-2BA21

(http://www.automation.siemens.com/bilddb/index.aspx?objKey=G_KT01_XX_00427)

6EP1961-2BA31

(http://www.automation.siemens.com/bilddb/index.aspx?objKey=G_KT01_XX_00742)

6EP1961-2BA41

(http://www.automation.siemens.com/bilddb/index.aspx?objKey=G_KT01_XX_00745)

6EP1961-2BA51

(http://www.automation.siemens.com/bilddb/index.aspx?objKey=G_KT01_XX_01240)

6EP1961-2BA61

(http://www.automation.siemens.com/bilddb/index.aspx?objKey=G_KT01_XX_01241)

Safety, approvals, EMC

7.1 Safety

	6EP1961-2BA00	6EP1961-2BA31	6EP1961-2BA51
	6EP1961-2BA11	6EP1961-2BA41	6EP1961-2BA61
	6EP1961-2BA21		
Standard for safety	acc. to EN 60950-1 and EN 50178		
Protection class	Class III		
Degree of protection (EN 60529)	IP20		

7.2 Approvals

	6EP1961-2BA00	6EP1961-2BA11 6EP1961-2BA21 6EP1961-2BA51	6EP1961-2BA31 6EP1961-2BA41 6EP1961-2BA61
CE marking	Yes, (2014/35/EU, 2014/30/EU, 2011/65/EU and 2014/34/EU)		
CB approval	Yes	Yes	Yes
UL/cUL (CSA) approval	cURus (UL 2367) File E328600; cULus (UL 508, CSA C22.2 No. 107.1) File E197259; cURus (UL 60950, CSA C22.2 No. 60950) File E151273	cURus (UL 2367) File E328600; cULus (UL 508, CSA C22.2 No. 107.1) File E197259	
• Remark:		<p>The combination of the listed Siemens AG power supply and solid-state overcurrent protector models 6EP1961, followed by -2BA51 or -2BA61 additionally create a limited voltage/current circuit.</p> <p>Devices 6EP1961-2BA51 and -2BA61 additionally fulfill the conditions for "Class 2 output" according to UL 1310 (maximum 100 VA)</p>	
Explosion protection	Yes	Yes	Yes
ATEX approval	II 3G Ex nA nC IIC T4 Gc	II 3G Ex nA nC IIC T4 Gc (EPS 9 ATEX 1 169 X)	II 3G Ex nA IIC T4 Gc (EPS 9 ATEX 1 169 X)
IECEX approval	-	IECEX EPS 14.0067X	IECEX EPS 14.0067X
cCSAus HazLoc	Class I, Div 2, Group A,B,C,D T4 Class I Zone 2		
cULus HazLoc	-	Class I, Div 2, Group A,B,C,D T4	Class I, Div 2, Group A,B,C,D T4
Marine approvals	-	DNV-GL, ABS	DNV-GL, ABS
RCM	Yes	Yes	Yes
EAC	Yes	Yes	Yes

7.3 EMC

	6EP1961-2BA00	6EP1961-2BA31	6EP1961-2BA51
	6EP1961-2BA11	6EP1961-2BA41	6EP1961-2BA61
	6EP1961-2BA21		
Emitted interference	EN 55022 Class B		
Noise immunity	EN 61000-6-2		

Environmental conditions

	6EP1961-2BA00	6EP1961-2BA11 6EP1961-2BA21 6EP1961-2BA51	6EP1961-2BA31 6EP1961-2BA41 6EP1961-2BA61
Ambient temperature	0 ... 60 °C for natural convection (self convection) -25 ... 60 °C for natural convection		
	Tested according to: <ul style="list-style-type: none"> • EN 60068-2-1 cold • EN 60068-2-2 dry heat • EN 60068-2-78 humid heat, constant • EN 60068-2-14 temperature change 		
Transport and storage temperature	-40 ... 85 °C		
	Tests (packed for shipping) according to: <ul style="list-style-type: none"> • EN 60068-2-1 cold • EN 60068-2-2 dry heat • EN 60068-2-30 humid heat, cyclic 		
Humidity class	Climatic class 3K3 according to EN 60721, 5 - 95 % no condensation		
Degree of pollution	2		
Mechanical stressing in operation	<ul style="list-style-type: none"> • Tested according to EN 60068-2-6 vibration, test Fc: <ul style="list-style-type: none"> 3.5 mm deflection in the range 5 - 8.4 Hz 2 g acceleration in the range 8.4 - 150 Hz • Tested according to EN 60068-2-27 shock, test Ea: <ul style="list-style-type: none"> acceleration 150 m/s², test duration 11 ms 		
Damaging gases	Tested according to: <ul style="list-style-type: none"> • EN 60068-2-42 sulfur dioxide • EN 60068-2-43 hydrogen sulfide 		
Atmospheric pressure	Operation: <ul style="list-style-type: none"> • 1080 - 795 hPa (-1000 - 2000 m) • For operation at altitudes of 2000 - 6000 m above sea level: <ul style="list-style-type: none"> output must be derated by -7.5% / 1000 m or the ambient temperature must be reduced by 5 K / 1000 m (see Figure 4-4 Mounting height derating (Page 38)) Storage: <ul style="list-style-type: none"> • 1080 - 660 hPa (-1000 - 3500 m) 		

Environment

The devices are in conformance with RoHS.

As a rule, only non-silicon precipitating materials are used.

Disposal guidelines



Packaging and packaging aids can and should always be recycled. The product itself may not be disposed of as domestic refuse.

Service & Support

Technical support

Technical support for all IA/DT products can be accessed through the following communication channels:

- Telephone: + 49 (0) 911 895 7222
- Internet:
Web form for support request (<http://www.siemens.de/automation/support-request>)

Technical documentation on the Internet

Operating instructions and manuals for SITOP are available in the Internet:
Operating instructions/manuals (<http://www.siemens.com/sitop/manuals>)

SITOP power supply homepage

General news about our power supplies is available in the Internet at the SITOP home page:
SITOP (<http://www.siemens.com/sitop>)

Information material

SITOP information can be downloaded from the Internet:
Information and download center (<http://www.siemens.com/sitop-infomaterial>)

CAX data

2D/3D data and circuit diagram macros can be downloaded from the Internet:
Siemens image database (<http://www.siemens.com/sitop-cax>)

Request all CAX data via the CAX download manager:
CAX shopping cart (<http://www.siemens.com/cax>)

SITOP Selection Tool

Simply and quickly select the optimum the power supply or DC-UPS:
SITOP Selection Tool (<http://www.siemens.com/sitop-selection-tool>)

Online catalog and ordering system

The online catalog and the online ordering system are available through the Industry Mall homepage:
Industry Mall (<http://www.siemens.com/industrymall/de>)

Contact persons

If you have any questions regarding the use of our products, then contact the Siemens contact person in your regional Siemens sales office.

You can find these addresses as follows:

- On the Internet (<http://www.automation.siemens.com/partner>)
- Industry Mall (<http://www.siemens.com/industrymall/de>)