

WAGO I/O System 750/753

Decentralized Automation Technology

Serie 750, 753

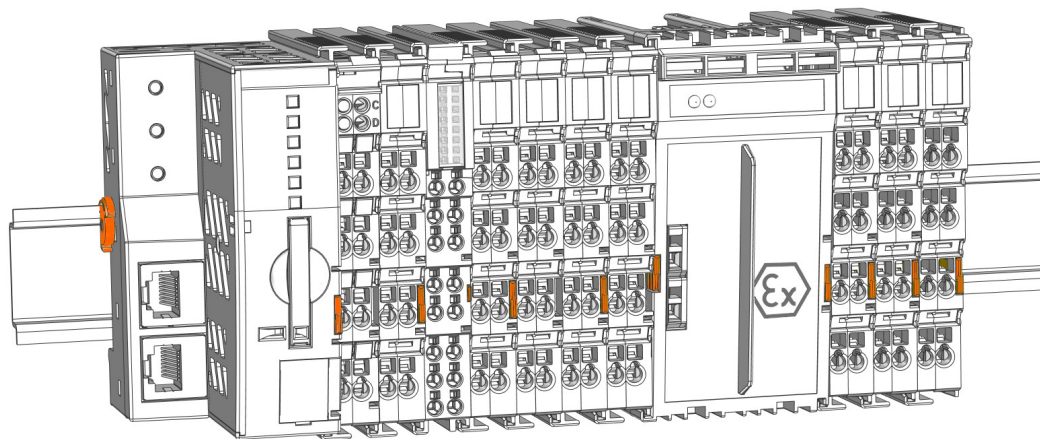

© 2023 WAGO GmbH & Co. KG
All rights reserved.

WAGO GmbH & Co. KG

Hansastraße 27
D - 32423 Minden

Phone: +49 571/887 – 0
Fax: +49 571/887 – 844169
E-Mail: ✉ info@wago.com
Internet: 🌐 www.wago.com

Technical Support

Phone: +49 571/887 – 44555
Fax: +49 571/887 – 844555
E-Mail: ✉ support@wago.com

Every conceivable measure has been taken to ensure the accuracy and completeness of this documentation. However, as errors can never be fully excluded, we always appreciate any information or suggestions for improving the documentation.

E-Mail: ✉ documentation@wago.com

We wish to point out that the software and hardware terms as well as the trademarks of companies used and/or mentioned in the present manual are generally protected by trademark or patent.

WAGO is a registered trademark of WAGO Verwaltungsgesellschaft mbH.

Table of Contents

Provisions	6
1.1 Validity of this Documentation	6
1.2 Intended Use	6
1.3 Typographical Conventions	7
1.4 Legal Information	9
Safety	10
2.1 General Safety Regulations	10
2.2 Elektrische Sicherheit	10
2.3 Mechanical Safety	11
2.4 Thermal Safety	11
2.5 Indirect Safety	11
System Features	12
3.1 Component Structure	12
3.1.1 Designs	12
3.1.2 Structure of the Head Stations	13
3.1.3 I/O Module Configuration	15
3.1.4 Product Identification	18
3.1.4.1 Versions	18
3.1.4.2 Marking	19
3.1.4.3 Identification	21
3.1.4.4 Update Matrix	21
3.1.5 System Contacts	21
3.1.5.1 Data Contacts	21
3.1.5.2 Power Jumper Contacts	22
3.1.5.3 DIN-Rail Contact	23
3.1.6 Coding Keys	23
3.1.7 Marking Elements	23
3.2 Electrical Structure	24
3.2.1 Potential Levels	24
3.2.2 System Supply	25
3.2.3 Field Supply	26
3.2.4 Power Supply Components	26
Functions	28
4.1 Process Image	28
Planning	29
5.1 Node Structure	29
5.2 Structure Guidelines	30
5.2.1 Warning Messages for Structure Guidelines	30
5.2.2 Safety Measures at the Installation Location	30
5.2.3 Overcurrent Protection	30
5.2.4 Protective Conductor and Protective Ground	31
5.2.5 Buffering	31

5.2.6	Mounting Position and Clearances.....	31
5.2.7	DIN-Rail Characteristics	32
5.2.8	EMC Installations.....	33
5.2.9	Data Security.....	33
5.3	Designing the System Supply.....	34
5.4	Field Supply Layout	35
5.5	Special Applications and Environments	35
5.5.1	Marine and Offshore.....	35
5.5.2	Ex i Applications	38
5.5.3	Marine and Offshore Ex i Applications	39
5.5.4	Functional Safety.....	41
5.5.4.1	Power Supply Concept.....	41
5.6	Examples and Aids.....	42
5.6.1	Aids.....	42
5.6.2	I/O Test.....	43
	Transport and Storage	45
	Assembly and Disassembly	46
7.1	Warning Messages for Assembly and Disassembly.....	46
7.2	Assembly Sequence.....	46
7.3	Snapping the Head Station to the DIN-Rail	46
7.4	Attaching an I/O Module	47
7.5	Removing a Head Station from the DIN-Rail.....	48
7.6	Removing an I/O Module.....	49
7.7	Inserting Coding Keys	51
	Conductor Termination	53
8.1	Conductor Termination	53
8.1.1	Connecting Conductors to CAGE CLAMP®.....	53
8.1.2	Connecting Conductors to Push-in CAGE CLAMP®	54
	Decommissioning.....	55
9.1	Shutting Down	55
9.2	Disposal and Recycling	55
	Appendix	56
10.1	Installation Regulations Specified by Approvals.....	56
10.1.1	Special Notes Regarding Explosion Protection.....	56
10.1.2	UL Requirements from Installation Regulations	57
10.1.2.1	UL Ordinary Locations per Report Reference E175199-19970402	57
10.1.2.2	UL Ordinary Locations per Report Reference E175199-20180807	57
10.1.2.3	UL Ordinary Locations per Report Reference E175199-20181019	58
10.1.2.4	UL Ordinary Locations per Report Reference E175199-20210716	58
10.1.2.5	UL Ordinary Locations per Report Reference E175199-20230421	59
10.1.2.6	UL Hazardous Locations per Report Reference E198726-19980911	59
10.1.2.7	UL Hazardous Locations per Report Reference E198726-2023-01-31	61

10.2 Protected Rights	61
10.3 Accessories	62

Provisions

1.1 Validity of this Documentation

This document applies to the I/O system:

WAGO I/O System 750/753 (Series 750, 753).

The complete operating instructions for the I/O system consists of several, applicable documents. The I/O system must only be installed and operated in accordance with the complete operating instructions. Knowledge of all applicable documents is required for proper use. Please find all documents and information on the product detail pages.

Please find all documents and information at:

 www.wago.com/all_750_753

Applicable documents

 **Product manuals** of used products

1.2 Intended Use

The I/O system is used to receive digital and analog signals from sensors and to control actuators. Higher-level controllers can be communicated with through fieldbus interfaces. The signals can be (pre-)processed with the controllers.

The products are open type devices and are designed for installation in an additional enclosure. In order to use them, it is connect to take protective measures suitable for the specific application.

- The products are intended for installation in automation technology systems.
- The products are designed for use in dry indoor rooms.
- Operation of the products in industrial areas is permitted.
- The products meet the EMC requirements for the residential, office and commercial area as well as small business, if the products used comply with the required emissions of interference (emission limits).
- Operation of the products in other application areas is only permitted when corresponding approvals and labeling are present.

Improper Use

Improper use of the products is not permitted. Specifically, improper use occurs in the following cases:

- Non-observance of the intended use
- Use without protective measures in an environment in which moisture, salt water, salt spray mist, dust, corrosive fumes, gases, direct sunlight or ionizing radiation can occur
- Use of the products in areas with special risk that require continuous fault-free operation and in which failure or operation of the product can result in an imminent risk to life, limb or health or cause serious damage to property or the environment (such as the operation of nuclear power plants, weapon systems, aircraft and motor vehicles)

Warranty and Liability

The provisions of the latest WAGO General Terms and Conditions of Deliveries and Services (GTC) apply as well as the Software License Terms for Standard Software (SW-Li-cense) applicable to software products und software embedded in WAGO hardware prod-ucts, both available at: www.wago.com.

In particular, the warranty is void if:

- The products are used improperly.
- The deficiency (hardware and software configurations) is due to special instructions.
- Modifications to the hardware or software have been made by the user or third parties that are not described in this documentation and that has contributed to the fault.

Individual agreements always have priority.

Obligations of Installers/Operators

The installers and operators bear responsibility for the safety of an installation or a sys-tem assembled with the products. The installer/operator is responsible for proper con-struction and safety of the installation. All laws, standards, guidelines, local regulations and accepted technology standards and practices applicable at the time of installation, and the instructions in the the products' Instructions for Use, must be complied with. In addition, the installment requirements for licensing must be observed. In the event of non-compliance, the products may not be operated within the scope of the approval.

1.3 Typographical Conventions





Number Notation

100	Decimals: Normal notation
0x64	Hexadecimals: C-notation
'100'	Binary: In single quotation marks
'0110.0100'	Nibbles separated by a period

Text Formatting

<i>italic</i>	Names of paths or files
bold	Menu items, entry or selection fields, emphasis
Code	Sections of program code
>	Selection of a menu point from a menu
"Value"	Value entries
[F5]	Identification of buttons or keys

Cross References / Links

	Cross references/links to a topic in a document
	Cross references / links to a separate document
	Cross references / links to a website
	Cross references / links to an email address

Sequence of Action

- ✓ This symbol identifies a precondition.
- 1. Action step
- 2. Action step
 - ⇒ This symbol identifies an intermediate result.
- ⇒ This symbol identifies the result of an action.
- Individual action step

Lists

- Lists, first level
 - Lists, second level

Figures

Figures in this documentation are for better understanding and may differ from the actual product design.

Warning Messages

DANGER

Type and source of hazard

Indicates an imminently hazardous situation which, if not avoided, will result in death or serious injury.

- Action step to reduce risk

WARNING

Type and source of hazard

Indicates a potentially hazardous situation which, if not avoided, could result in death or serious injury.

- Action step to reduce risk

CAUTION

Type and source of hazard

Indicates a potentially hazardous situation which, if not avoided, may result in minor or moderate injury.

- Action step to reduce risk

! NOTICE**Type and source of malfunction (property damage only)**

Indicates a potentially hazardous situation which, if not avoided, may result in damage to property.

- Action step to reduce risk

Information Notices**i Note****Information**

Indicates information, clarifications, recommendations, referrals, etc.

1.4 Legal Information

Intellectual property

The intellectual property of this document belongs to WAGO GmbH & Co. KG. The reproduction and distribution of its content (in whole or in part) is prohibited, unless otherwise provided by statutory provisions, written agreements or this document. In case of doubt, the written consent of WAGO GmbH & Co. KG must be obtained in advance.

Third-party products are always mentioned without any reference to patent rights. WAGO GmbH & Co. KG, or the manufacturer of third-party products, retains all rights regarding patent, utility model or design registration.

Third-party trademarks are referred to in the product documentation. The “®” and “™” symbols are omitted hereinafter. The trademarks are listed in the Appendix:  **Protected Rights [▶ 61]**.

Subject to Change

The instructions, guidelines, standards, etc., in this manual correspond to state of the art at the time the documentation was created and are not subject to updating service. The installer and operator bear sole responsibility to ensure they are complied with in their currently applicable form. WAGO GmbH & Co. KG retains the right to carry out technical changes and improvements of the products and the data, specifications and illustrations of this manual. All claims for change or improvement of products that have already been delivered – excepting change or improvement performed under guarantee agreement – are excluded.

Licenses

The products may contain open-source software. The requisite license information is saved in the products. This information is also available under:  www.wago.com.

Safety



This section lists installation regulations that must be observed for safe operation of the I/O System.

2.1 General Safety Regulations

- This documentation is part of the Products. Retain the documentation for the entire service life of the Products. Pass on the documentation to any subsequent user of the Products. In addition, ensure that any supplement to this documentation is included, if necessary.
- The Products must only be installed and put into operation by qualified electrical specialists per EN 50110-1/-2 and IEC 60364.
- Comply with the laws, standards, guidelines, local regulations and accepted technology standards and practices applicable at the time of installation.

2.2 Elektrische Sicherheit

- Disconnect all power supplies from the product before performing any installation, repair or maintenance.
- Make sure the products do not carry any voltage before starting work.

Power Supply

- For non-hazardous active voltage per EN/UL/IEC 61010-1, SELV/PELV power supplies shall be used.
- When configuring the system, make sure that the maximum total current of the field supply of the node is not exceeded. Where needed, include an additional supply module.
- When configuring the system, make sure that the maximum total current of the system supply of the node is not exceeded. Where needed, include an additional supply module.
- Pay attention to the permissible voltage and frequency ranges of the products when using different supplies.
- Plan for voltage buffering if the requirement for voltage buffering according to EN 61131-2 is to be met.
- Take suitable measures to protect against overload (e.g., a supply module with fuse or an external fuse).
- In mixed operation, always separate the areas in the XTR version and the areas with the standard version with the separate potential supply modules for the field supply and separate power supply units of the respective version in different potential groups. Do not mix the versions within a potential group.

Grounding/Protection/Fuses

- Establish sufficient grounding. Make sure there is a flawless electrical connection between the DIN-rail and frame / additional enclosure.
- Connect the DIN-rail to protective earth (PE) when using hazardous active voltages.

- In systems operated within the scope of UL, only use UL-approved fuses.

Cables

- To minimize interference (e.g., by electromagnetic interference), maintain a spatial separation between control, signal and data lines and the power supply lines.
- SELV/PELV circuits must be safely disconnected from circuits with hazardous active voltage or all connecting cables must be designed for the maximum current load.
- The conductor cross-sections specified in the product manual refer exclusively to the mechanical connection capacity of the clamping points. Always use connecting cables designed for the maximum current load.
- Additional heat can be produced at the clamping point by high currents and inherent heat generated by the product. Plan a higher temperature range for the conductors, or reduce inherent heat by selecting larger conductor cross-sections.
- Only one conductor may be connected to each connection point (e.g., CAGE CLAMP® connection).

Protection

- When working on the system (e.g., during maintenance), protect the facility part in question from accidental or unauthorized restart.

2.3 Mechanical Safety

- Before start-up, check the product for any damage that may have occurred during shipping. Do not put the product into operation if there is any mechanical damage.
- Do not open the product housing.
- Do not touch the power jumper contacts.
- Avoid conductive contamination.

2.4 Thermal Safety

2.5 Indirect Safety

- Do not use any contact spray for cleaning.
- Clean product housings and soiled contacts with propanol.
- The products are not resistant to materials having seeping and insulating properties such as aerosols, silicones and triglycerides (found in some hand creams). If these substances occur in the environment of the products, install the products in an additional housing that is also resistant to these substances.
- Replace any defective or damaged devices.
- Do not place products on the data or power jumper contacts.
- If product fails, communication to downstream products may be interrupted.
- Products from the WAGO I/O System 750/753 can be operated in combination with those of the WAGO I/O System 750 XTR. For combined operation, take the specifications for the ambient conditions for both I/O Systems into account.
- Operate ETHERNET and PROFINET interfaces in separate networks.
- Only use accessories authorized by WAGO.

System Features

3.1 Component Structure

3.1.1 Designs

Head Stations

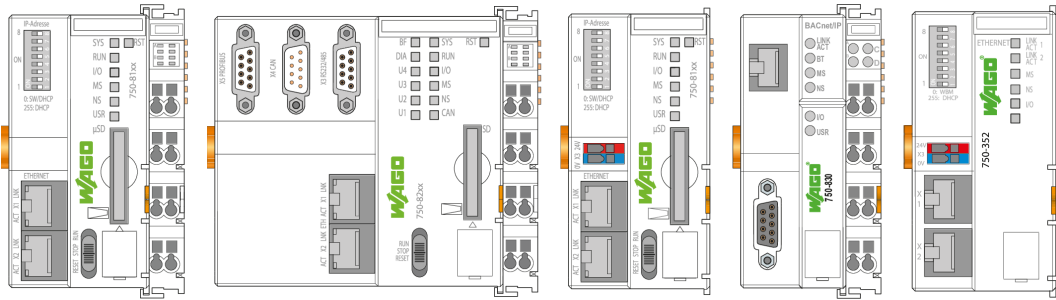

Figure 1: Example Head Station Housings

The housings of head stations (fieldbus couplers or controllers) may differ, for instance in terms of:

- The connection level with or without field-side power supply (Eco)
- The operator control elements and indicators
- The specific fieldbus interfaces
- Further communication interfaces

I/O Modules

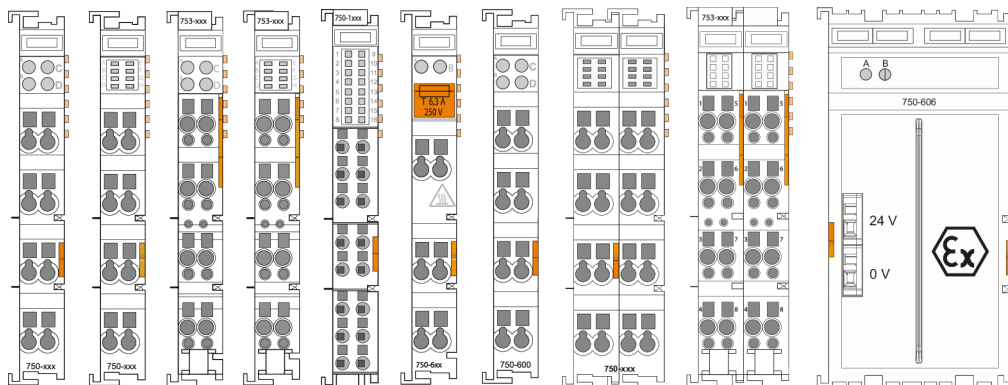

Figure 2: Example I/O Module Housings

The housings of the I/O modules differ in terms of:

The housings of the I/O modules may differ, for instance in terms of:

- The module width (12 mm, 24 mm or 48 mm)
- The structure of the wiring interface (CAGE CLAMP® or Push-in CAGE CLAMP® connections)
- Different indicators
- The number of power jumper contacts
- The fuse holder (supply module)
- The protective cover (distance module)

3.1.2 Structure of the Head Stations

Beispielansicht PFC

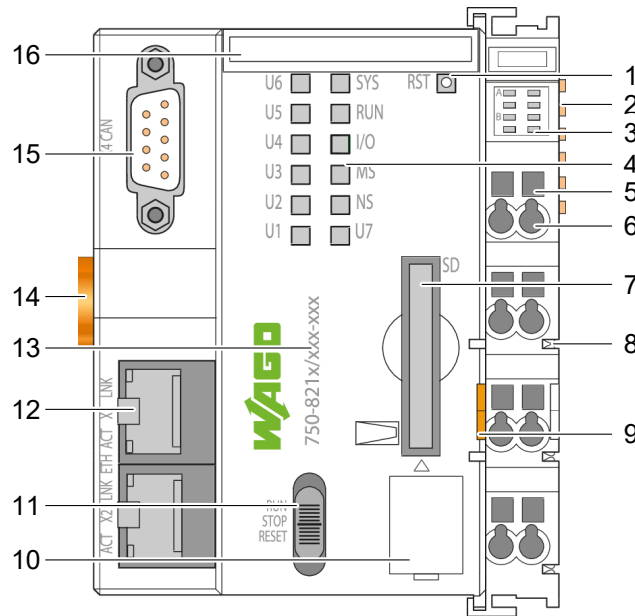

Figure 3: Beispielansicht PFC

1	Reset button	Product Manual
2	Data contacts	System Contacts [▶ 21]
3	Display elements: Power supply status	Product Manual
4	Display elements: System status	Product Manual
5	Access to open the associated CAGE CLAMP® connection	Conductor Termination [▶ 53]
6	CAGE CLAMP® connection for the power supply connection	
7	Memory card slot with protective flap	Product Manual
8	Power jumper contact (spring)	System Contacts [▶ 21]
9	Release tab	Assembly and Disassembly [▶ 46]
10	Service interface cover	Product Manual
11	Mode selector switch	Product Manual
12	Network connection	Product Manual
13	Item number	Product Identification [▶ 18]
14	DIN-rail locking cam	Assembly and Disassembly [▶ 46]
15	Serial interface (optional)	Product Manual
16	Slot for Mini-WSB (optional)	Marking Elements [▶ 23] Versions [▶ 18]

Beispielansicht Feldbuskoppler/Controller

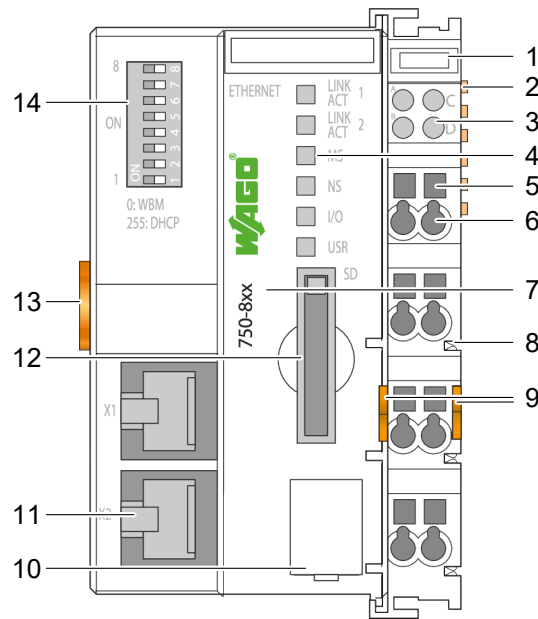

Figure 4: Beispielansicht Controller

1	Slot for Mini-WSB (optional)	✔ Marking Elements [▶ 23] ✔ Versions [▶ 18]
2	Data contacts	✔ System Contacts [▶ 21]
3	Display elements: Power supply status	📖 Product Manual
4	Display elements: Fieldbus status	📖 Product Manual
5	Access to open the associated CAGE CLAMP® connection	✔ Conductor Termination [▶ 53]
6	CAGE CLAMP® connection for the power supply connection	
7	Item number	✔ Product Identification [▶ 18]
8	Power jumper contact (spring)	✔ System Contacts [▶ 21]
9	Release tab	✔ Assembly and Disassembly [▶ 46]
10	Service interface cover	📖 Product Manual
11	Fieldbus connection (optional)	📖 Product Manual
12	Memory card slot with protective flap	📖 Product Manual
13	DIN-rail locking cam	✔ Assembly and Disassembly [▶ 46]
14	Address selection switch (optional)	📖 Product Manual

3.1.3 I/O Module Configuration

Example View of the 750 Series I/O Module (CAGE CLAMP® Connections)

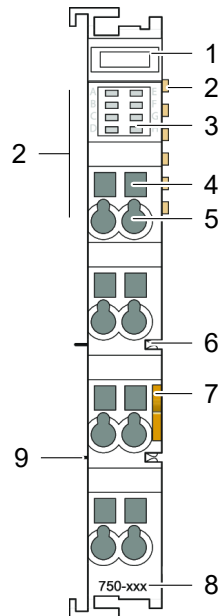

Figure 5: 750 Series I/O Module with CAGE CLAMP® Connections (Example)

1	Slot for Mini-WSB (optional)	🔗 Marking Elements [▶ 23] 🔗 Versions [▶ 18]
2	Data contacts	🔗 System Contacts [▶ 21]
3	Indicators	📖 Product Manual
4	Access to open the associated CAGE CLAMP® connection	🔗 Conductor Termination [▶ 53]
5	CAGE CLAMP® connection	
6	Power jumper contact (spring)	🔗 System Contacts [▶ 21]
7	Release tab	🔗 Assembly and Disassembly [▶ 46]
8	Item number	🔗 Product Identification [▶ 18]
9	Power jumper contact (blade)	🔗 System Contacts [▶ 21]

Example View of the 750 Series I/O Module (Push-in CAGE CLAMP® Connections)

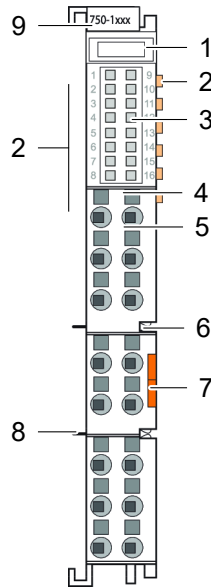

Figure 6: 750 Series I/O Module with Push-in CAGE CLAMP® Connections (Example)

1	Slot for Mini-WSB (optional)	🔗 Marking Elements [▶ 23] 🔗 Versions [▶ 18]
2	Data contacts	🔗 System Contacts [▶ 21]
3	Indicators	📖 Product Manual
4	Access to open the associated Push-in CAGE CLAMP® connection	🔗 Conductor Termination [▶ 53]
5	Push-in CAGE CLAMP® connection	
6	Power jumper contact (spring)	🔗 System Contacts [▶ 21]
7	Release tab	🔗 Assembly and Disassembly [▶ 46]
8	Power jumper contact (blade)	🔗 System Contacts [▶ 21]
9	Item number	🔗 Product Identification [▶ 18]

Example View of the 753 Series I/O Module (Pluggable Connector)

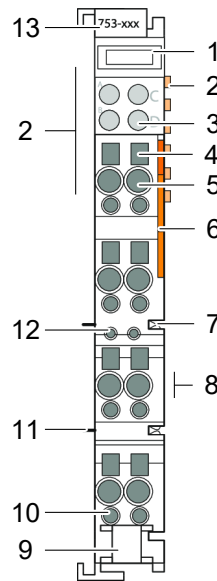

Figure 7: 753 Series I/O Module (Example)

1	Slot for Mini-WSB (optional)	🔗 Marking Elements [▶ 23] 🔗 Versions [▶ 18]
2	Data contacts	🔗 System Contacts [▶ 21]
3	Indicators	📖 Product Manual
4	Access to open the associated CAGE CLAMP® connection	🔗 Conductor Termination [▶ 53]
5	CAGE CLAMP® connection	
6	Release tab for the pluggable connector	🔗 Assembly and Disassembly [▶ 46]
7	Power jumper contact (spring)	🔗 System Contacts [▶ 21]
8	Release tab for the I/O module	🔗 Assembly and Disassembly [▶ 46]
9	Fastening clip for cable ties	
10	Test slot for the associated CAGE CLAMP® connection	
11	Power jumper contact (blade)	🔗 System Contacts [▶ 21]
12	Coding key	🔗 Assembly and Disassembly [▶ 46]
13	Item number	🔗 Product Identification [▶ 18]

3.1.4 Product Identification

3.1.4.1 Versions

Color Coding for Identifying the Component Type

To get an overview of the different I/O components quickly and easily, they are color-coded.

Table 1: Color coding of Component Types

Housing Color	Component Type
Light gray	WAGO I/O System 750/753 (standard modules)
Blue	Intrinsically safe modules (Ex i)
Signal yellow	Modules for functional safety
Blue + signal yellow	Intrinsically safe modules (Ex i) for functional safety
Dark gray	WAGO I/O System 750 XTR
Blue + dark gray	WAGO I/O System 750 XTR – intrinsically safe modules (Ex i)

Color Coding for Identifying Functionality

To allow you to get an overview of the component classes present in a node quickly and easily, they are color-coded.

- Housings with up to four round indicators have permanently installed color-coded pull-out labeling fields.
- I/O modules in the 8-channel housing can be color-coded by attaching marking elements (Mini-WSB) above the indicators.
- For housings with 16 indicators, they are highlighted in color.

Table 2: Color Coding of Component Classes

Coding Key Color	Component Class
Green	Analog inputs
Blue	Analog outputs
Yellow	Digital inputs
Red	Digital outputs
Transparent	Supply modules, function and technology modules

3.1.4.2 Marking

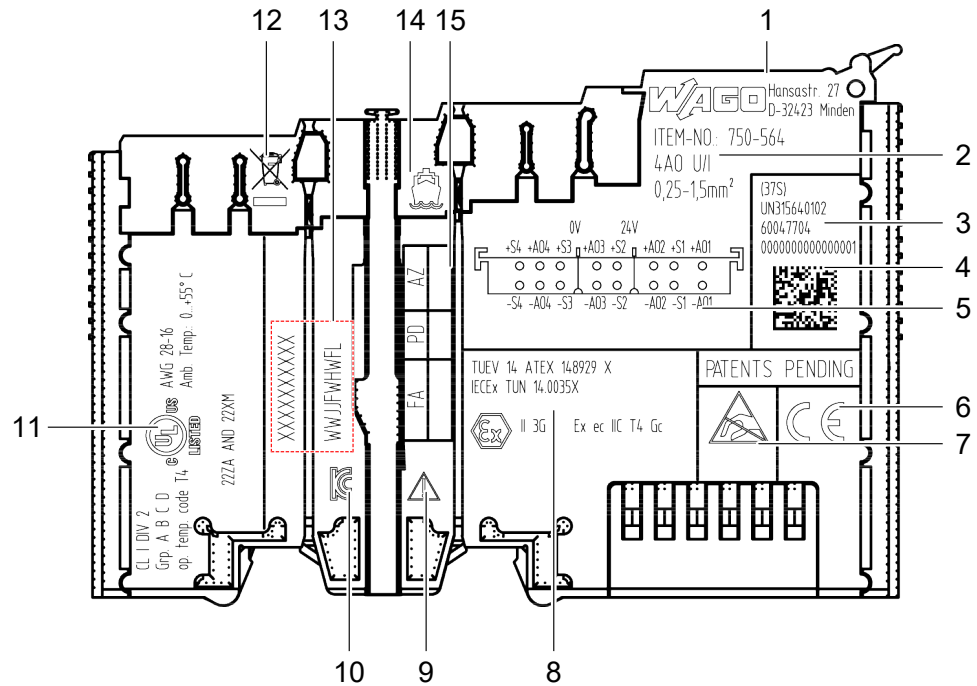

Table 3: Explanation of the Marking Example

No.	Content	Description
1	WAGO logo and address	WAGO GmbH & Co. KG
2	Product information	Item number and product description; conductor cross-section if applicable
3		Production data
4		DataMatrix code (production data)
5	Terminal allocation	For more information on Sprungziel: Anhang, see the corresponding Product Manual .
6	CE mark	With the CE mark, WAGO declares that the product meets the applicable requirements as set out in Community harmonization legislation per EC Regulation 765/2008, which allows the product to carry this mark.
7	"ESD" mark	Note: Avoid electrostatic discharge! The products are equipped with electronic components that may be destroyed by electrostatic discharge when touched. Please following the safety precautions per DIN EN 61340-5-1/-3 to prevent electrostatic discharge.
8	"Ex" registration icon	The product meets the classified requirements according to ATEX for operation in hazardous areas. For more information on approvals, see the corresponding Product Manual .















No.	Content	Description
9	 "Caution" exclamation icon	Note: Observe the product documentation! Applicable information and documents concerning the product exist which must be observed.
10	 "KC" registration icon	This approval mark indicates compliance with Korean product safety requirements for electrical and electronic devices and components.
11	 "UL Listed" mark	"Certification Mark for Safety" of UL-listed product in the North America and Canadian market
12	 "WEEE" mark	Note: Electrical and electronic equipment must not be disposed of with household waste! Electrical and electronic equipment contains materials and substances that can be harmful to the environment and health. Electrical and electronic equipment must be disposed of properly after use. For more information on this topic, see Disposal and Recycling [p. 55] .
13	Production number	Identification [p. 21]
14	 "Marine approvals" icon	Collective icon for marine approvals For more information on this topic, see Special Applications and Environments [p. 35] . For more information on the topic of approvals, see the corresponding Product Manual .
15	Update matrix	Update Matrix [p. 21]

Table 4: Explanation of the Example of Different Marking

No.	Content	Description
	 UKCA	The UKCA (UK Conformity Assessed) mark declares that the conformity requirements for the UK market are met.
	 "RFID" icon	This product contains RFID (Radio Frequency Identification) technology.
	 "Hot surface" warning symbol	Warning: Do not touch hot surfaces! The housing surface can become hot during operation. If the product has been used in high ambient temperatures, let it cool down before touching it.
	 "TÜV" registration icon	TÜV (Technischer Überwachungsverein) Rheinland® as the testing laboratory for functional safety
	 "FS" registration icon	Conformity marks with the keyword "Functional Safety" are issued for electrical/electronic/programmable electronic and electromechanical products that are intended for use in safety-related applications.
	 "RCM" mark	With the RCM mark (Regulatory Compliance Mark), WAGO declares that the product meets the applicable requirements according to Australian standards.
	 "CCC" mark	With the CCC (China Compulsory Certification) mark, WAGO declares that the product meets the applicable requirements according to standards valid for the Chinese market.

No.	Content	Description
		“EAC” icon The EAC mark indicates that the product conforms to the safety requirements set forth in the EEU technical requirements.
		“EAC Ex” icon The EAC Ex mark indicates that the product meets the safety requirements set forth in the EEU technical requirements for operation in hazardous areas.
		“UL Recognized” mark “Certification Mark for Safety” of UL-recognized components for the North America and Canadian market

For head stations, to ensure that the serial number can also be read when they are installed, this is also printed on the front, on the cover flap of the service interface.

3.1.4.3 Identification

The production number contains internal production data, as well as product-specific production data. The production number can be:

- One row: XXXXXXXXXXXX_WWYYFWHWFL
- Two row: XXXXXXXXXXXX
WWYYFWHWFL

Table 5: Production Number

XXXXXXXXXX	Production order number, 10-digit
WWYYFWHWFL	WW: production week YY: production year FW: firmware index HW: hardware index FL: firmware loader index

3.1.4.4 Update Matrix

In the event of a factory update, the updated production data is documented in the update matrix. The initial manufacturing information on the product housing remains unchanged. In the case of a head station, the updated production number is also printed on the cover flap of the service interface.

Table 6: Update Matrix

FA	XXXXXXXXXX	Production order number, 10-digit
PD	WWYY	WW: production week YY: production year
AZ	FWHWFL	FW: firmware index HW: hardware index FL: firmware loader index

3.1.5 System Contacts

3.1.5.1 Data Contacts

The data contacts have the following function:

1. Forwarding of the system supply to subsequent I/O modules
2. Communication between head station and I/O modules

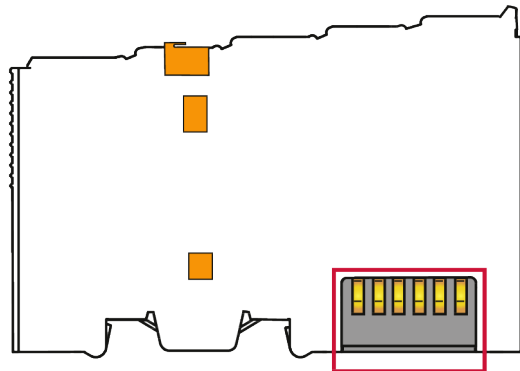

Figure 8: Data Contacts

3.1.5.2 Power Jumper Contacts

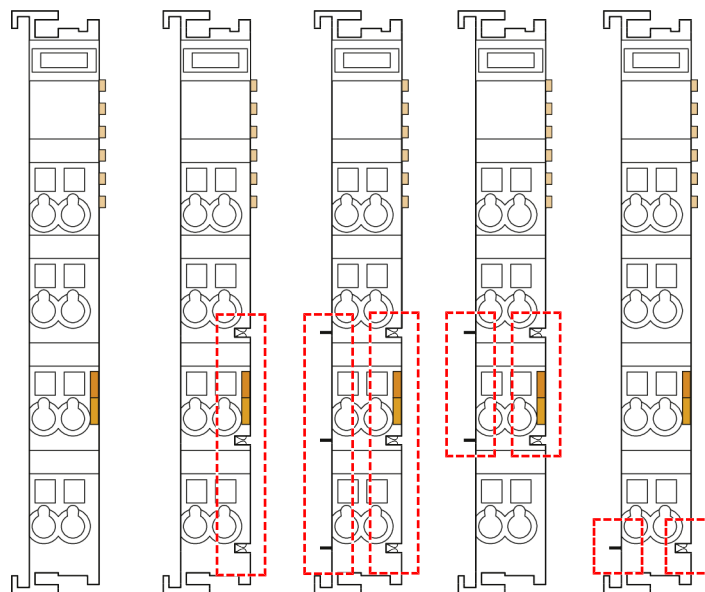

Figure 9: Example of Power Jumper Contact Arrangement (Left: Blade Contacts; Right: Spring Contacts)

Potentials of the Power Jumper Contacts

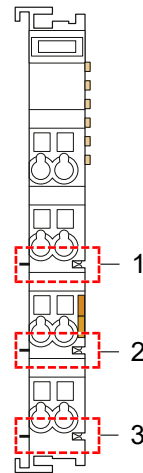

Figure 10: Potentials of the Power Jumper Contacts

1	1st potential of the field power supply
2	2nd potential of the field power supply, usually 0 V/ground potential
3	Functional ground (FE)

3.1.5.3 DIN-Rail Contact

Many components of the I/O system transmit electromagnetic interference to the DIN-rail via DIN-rail contacts. The DIN-rail contacts of the modules are automatically connected when they are snapped on to the DIN-rail.

For the I/O modules, there is usually no direct connection between the DIN-rail contact and the ground connections of the wiring interface and the associated power jumper contacts. The specific design is described in [Product Manual](#).

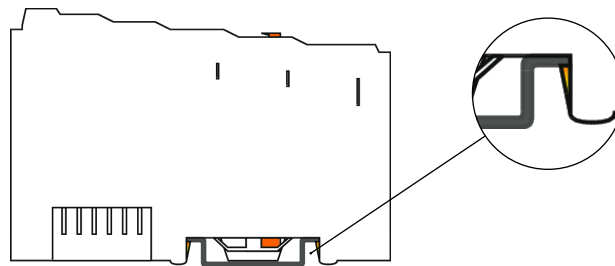

Figure 11: DIN-Rail Contact (example)

3.1.6 Coding Keys

I/O modules of the 753 Series and the associated plug-in wiring interfaces can have coding keys to prevent incorrect insertion. The coding using small plastic pins and sockets simplifies assignment of the wiring interface to the I/O module.

More information about this topic: [Inserting Coding Keys \[► 51\]](#)

3.1.7 Marking Elements

The system components can be provided with labeling elements:

- On head stations:
 - Above the indicators

- If there is a power supply infeed, above the individual connections
- On I/O modules of the 750 and 753 Series:
 - Above the indicators
- On some I/O modules of the 750 Series:
 - Above the individual connections

3.2 Electrical Structure

3.2.1 Potential Levels

The I/O system is divided internally into the following potential groups.

- **System Level**
This potential group encompasses all the system-side electronics and includes the system supply and local bus signals among other things.
- **Field Level**
This potential group contains the field-side power supply and I/O signals. The node structure can be divided into different sections with supply and segment modules. Different field potentials can be used in the individual sections.
- **Fieldbus**
This potential group contains the signals of the corresponding fieldbus interface. The voltage and current levels depend on the fieldbus standard used.
- **Functional Ground**
To discharge EMC interference, the system power supply, the field power supply and the I/O signal inputs and outputs are capacitively coupled within the module to the functional ground via the DIN-rail contacts.

I/O modules with dangerously active voltages on the field level are safely isolated from the system level. Functional isolation from the system level is provided for I/O modules with SELV/PELV voltages on the field level.

You can find product-specific information on “Isolation” in the technical data of the corresponding  **Product Manual**.

Example Potential Groups/Isolation with Electrically Isolated Power Supply Infeed

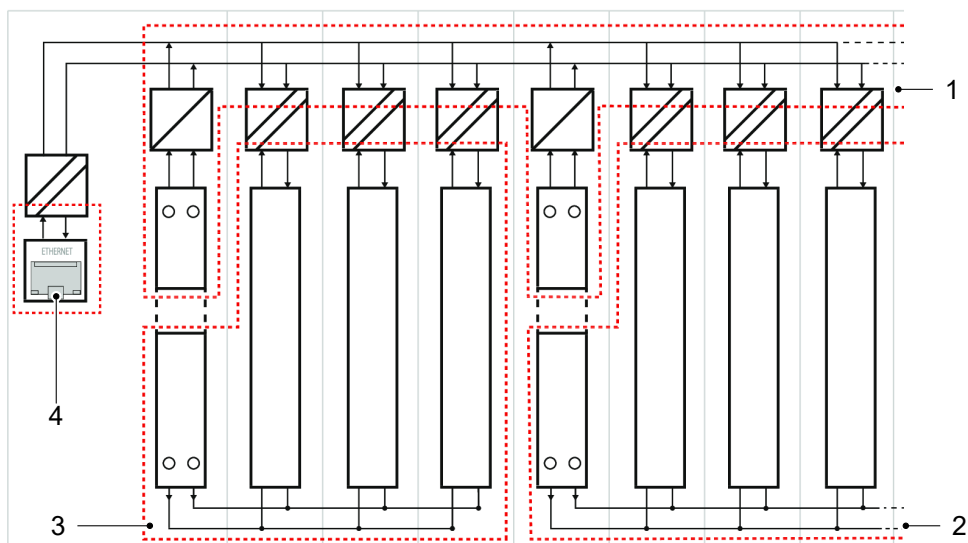

Figure 12: Illustration of the Various Potential Groups

1	System-level potential groups
2	Field-level potential groups in right node section
3	Field-level potential groups in left node section
4	Fieldbus system potential groups

3.2.2 System Supply

The system is supplied through the fieldbus coupler/controller and, where needed, through additional supply modules with bus power supplies. The system-side component electronics are protected against reverse polarity.

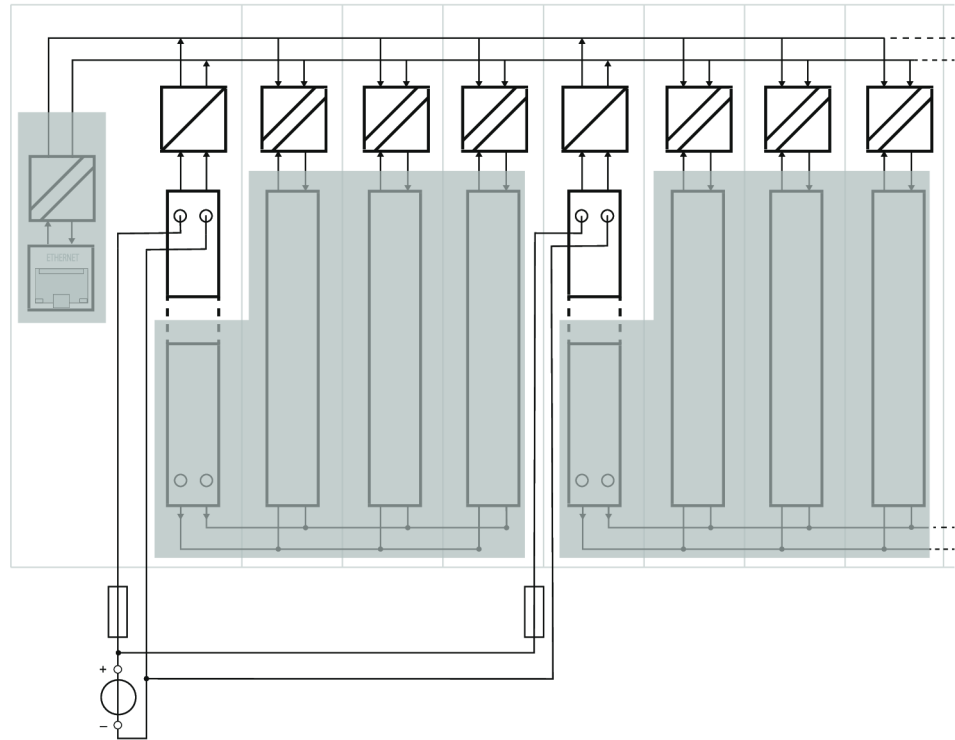



Figure 13: Supplying System Power (Example)

Observe the following requirements for system power supply:

- SELV/PELV power supplies shall be used.
- Power **must** be supplied simultaneously to **all** system power supply units. WAGO recommends using the same voltage source to realize the power supply.
- Use a suitable overcurrent protection for each infeed. Product-specific information is available in the respective  **Product Manual**.

3.2.3 Field Supply

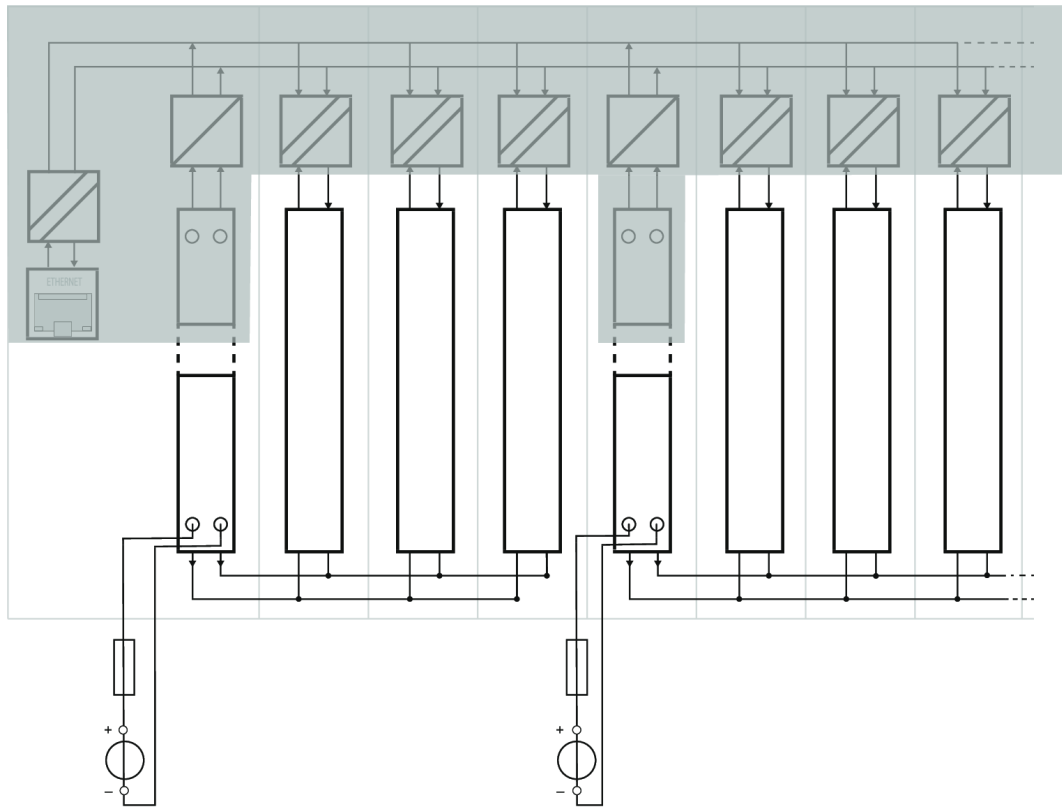



Figure 14: Field Supply Infeed (Example)

Observe the following requirements for the field supply:

- For non-hazardous active voltages per EN/UL/IEC 61010-1, use SELV/PELV power supplies.
- Use suitable overcurrent protection for each infeed. You can find detailed product information in the corresponding  **Product Manual**.

Additional supply modules are needed for:

- Higher power requirements
- Use of different reference voltages
- Use of different field voltages (e.g., 230 VAC, 120 VAC or 24 VDC)
- Switching to special applications and environments (e.g., Ex i)

Adding a supply module interrupts the field power supply that passes through the power jumper contacts. A new power infeed, which may also include a potential change, begins at that point.

3.2.4 Power Supply Components

The following components are needed in order to establish a power supply:

- **Voltage Sources**
 - SELV/PELV voltage sources for non-hazardous active voltages per EN/UL/IEC 61010-1
 - Voltage sources according to the field supply requirements
- **Overcurrent Protective Equipment**
 - Supply modules with integrated fuses
 - External fuse terminal blocks
 - Circuit-breakers

- **Suitable Isolation Devices**, e.g., non-automatic circuit-breaker
- **Supply Modules**
 - Bus power supplies
 - Supply module

Depending on the application area, the following may also be needed:



- **Filter modules**
- **Distance modules**
- **Voltage buffer**
 - UPS modules
 - Capacitive buffer modules

Functions

4.1 Process Image

After switching on, the head station identifies the inserted I/O modules that send or expect to receive data (data width > 0). The head station creates an internal local process image from the data width, the module type and the position of the I/O module in the node. This process image is divided into input and output data zones.

The head station provides one or more external process images that are used for data transmission via a fieldbus, for example. The structure of an external process image depends on:

- The selection and arrangement of the I/O modules in the node. Some I/O modules allow you to configure the arrangement and amount of the data they provide. Information on the process data provided by an I/O module is available in the  **Product Manual** of the I/O module.
- The properties of the external interface (e.g., of the fieldbus) and the properties of the head station. More information is available in the  **Product Manual** of the head station. Examples of process image properties that can differ among head stations:
 - Arrangement of the process data in the order of the physical placement of the I/O modules
 - Grouping of the process data so that analog field signals come before digital field signals
 - Insertion of filler bits or bytes so that data of an I/O module starts at a word boundary
 - Hiding of diagnostic bits from the process data of the I/O modules and/or mapping of them to fieldbus-specific diagnostic mechanisms
 - Adaptation of the endianness to the properties of the fieldbus
 - Limitation of the amount of data to packet sizes that can be processed by the fieldbus

Planning

This section provides helpful information for planning the use of the I/O system.

5.1 Node Structure

Note that product-specific configuration or test steps may be necessary. For example before:

- Commissioning
- Recommissioning
- Exchange and replacement of I/O modules

These configuration or test steps are described in the respective  **Product Manual**.

Types of Components

Several different types of components are used in the I/O system:

- **Head Stations:**
 - PFC
 - Controller
 - Fieldbus couplers
- **I/O Modules:**
 - Analog input and output modules
 - Digital input and output modules
 - Function and technology modules
 - Communication modules
 - Supply and segment modules

Node Configuration

A node configuration consists of at least the following:

- A head station
- A power supply
- An I/O module
- An end module

Structuring a Node

When planning a node, please take the following into account:

- Grouping by potential group
- Optical delimitation of the potential groups

For fast, effortless planning, use the WAGO Configurator Smart Designer.

Number of I/O Modules

The maximum number of I/O modules that can be operated in one node depends on several factors:

- **Mechanical Expansion:**

The distance between a head station and an end module must not exceed 768 mm, including the end module. If your node is wider, it must be divided into several sections with an additional fieldbus coupler, controller or internal data bus extension.

- **Addressability:**
Up to 250 I/O modules can be addressed, depending on the head station.
I/O modules that do not have any process or diagnostic data (e.g., distance modules) do not need to be taken into account when calculating the number.
- **Head Station Memory:**
Head stations have limited memory for the process image.
- **Fieldbus Technology Characteristics**

5.2 Structure Guidelines

5.2.1 Warning Messages for Structure Guidelines

WARNING

DIN-Rail Protection Connection!

If voltage is hazardous active on the I/O system, a protective connection of the DIN-rail to PE is required.

- Take this protective connection into account in your planning!

WARNING

Different Field Supplies on the Power Jumper Contacts!

Different field supplies can be fed into the I/O system. The respective power supply can be passed on to the following I/O modules via the power jumper contacts.

- In your planning, take into account that the field supply that is fed in is suitable for all I/O modules within a supply section!

5.2.2 Safety Measures at the Installation Location

Additional Enclosure

The I/O System is an open type device. It must only be installed within appropriate enclosures, cabinets or electrical operation rooms that fulfill at least the following requirements:

- Offer adequate protection against direct or indirect contact.
- Offer adequate protection against UV irradiation.
- Restrict access to authorized personnel and may only be opened with tools.
- Ensure the required pollution degree in the vicinity of the system.
- Prevent fire from spreading outside of the enclosure.
- Guarantee mechanical stability.

5.2.3 Overcurrent Protection

System and field supply are through the head station and/or additional supply modules.

Protect the power supply as specified in the technical product data. Use:

- Supply modules with integrated fuses
- External fuses
- Circuit-breakers

5.2.4 Protective Conductor and Protective Ground

The I/O System does not provide any protective conductor functionality via the field connections. If a field device connected to the I/O System requires a protective ground connection, this connection must not be implemented via the I/O System's field connection. If hazardous active voltages are used, the DIN-rail must be suitably connected to protective ground (PE).

5.2.5 Buffering

To compensate for power interruptions per IEC 61131 (PS-1 or PS-2), external buffering is required.

Buffer capacity depends on the node configuration, which is why it is not possible to provide general information on the required capacity.

5.2.6 Mounting Position and Clearances

Maintain at least the following clearances to adjacent components, cable ducts and the sides of enclosures and frames for the entire node structure.

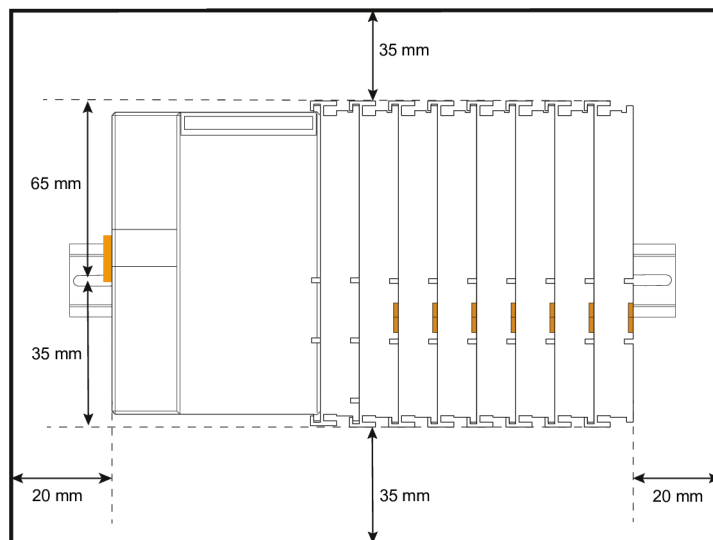

Figure 15: Installation Clearances

Coordinate Model

i Note

Modified coordinate model

In product documentation published before 2021, the height (y) and depth (z) were swapped!

- Width = dimension along x axis = horizontal in nominal mounting position; parallel to DIN-rail longitudinal axis
- Height = dimension along z axis = vertical in nominal mounting position
- Depth = dimension along y axis = horizontal in nominal mounting position; perpendicular to DIN-rail longitudinal axis

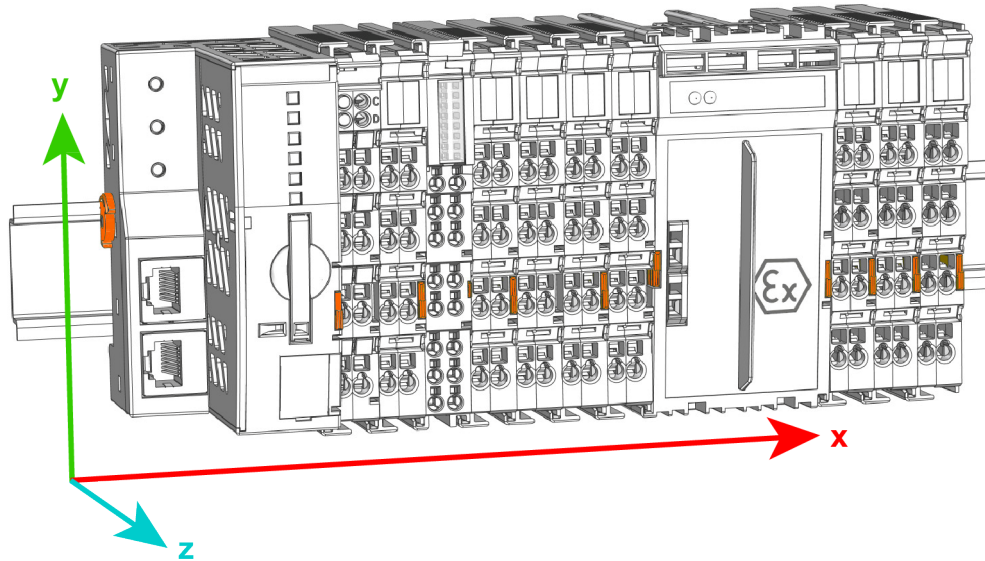

Figure 16: Coordinate model: width (x), height (y), depth (z)

Overview of Mounting Positions

The mounting positions shown correspond to the final orientation of the products within the additional enclosure.

Horizontal, left (nominal mounting position)	Horizontal, up (floor mounting position ¹⁾)	Horizontal, down (ceiling mounting position ¹⁾)
Horizontal, right	Vertical, top	Vertical, bottom
For vertical installation, always mount an end stop below the node to prevent it from slipping off.		

¹⁾ In conjunction with the additional enclosure

5.2.7 DIN-Rail Characteristics

To ensure optimum system construction, all system components can be securely snapped onto a DIN-rail (35 mm). Observe:

- The material must have high corrosion resistance.
- The DIN-rail geometry must not be altered.
- Prevent bending and twisting (torsion) e.g., by using sufficient attachment points.

- Use countersink-head screws, blind rivets, etc., to countersink the attachment points beneath the node structure.
- The component DIN-rail contact (CuSn6) must not form a galvanic element with the DIN-rail that is capable of generating a differential voltage of more than 0.5 V (saline solution of 0.3% at 20°C/68°F).

5.2.8 EMC Installations

- **Use filter modules for 24 V power supply lines longer than 30 m.**
To comply with EN 61000-6-2:2019, filter modules (750-626/xxx-xxx or 750-624/xxx-xxx) must be used for both system and field power supply lines that are longer than 30 m.
- **Ground DIN-rails.**
Ground the DIN-rails to divert electromagnetic interference.
- **Use shielded cables for data and signal lines.**
Electromagnetic interference is reduced and signal quality increased. Measurement errors, data transmission faults and interference due to excessive voltage can be prevented!
- **Keep data and signal lines separate from interference sources.**
Route data and signal lines separately from all power supply cables and other sources of high electromagnetic emissions (e.g., frequency converters or drives).
- **Connect the cable shielding with the ground potential.**
Integrated shielding is mandatory to meet technical specifications regarding measurement accuracy. Establish the connection between the cable shielding and ground potential at the inlet of the cabinet or housing. This grounding allows induced interferences to dissipate and be kept away from devices in the cabinet or housing.
- **Improve shielding performance with a large contact area.**
A low-impedance connection between shielding and ground achieves better shielding performance. For this purpose, connect the shielding over a large surface area, e.g., using the WAGO Series 790 Shield Connection System. This is especially recommended for large-scale systems where equalizing or high impulse currents may occur.

5.2.9 Data Security

Professional planning and design is an important requirement for securing data confidentiality, availability and integrity.

Random Influences

Data transmission and processing can be disrupted by random influences, such as temporary electromagnetic disturbances. Proper setup can significantly reduce the likelihood of corruption or destruction of data.

For additional information see:  [EMC Installations \[p. 33\]](#).

Deliberate Influences

Use in ETHERNET Areas

ETHERNET products are designed for use in local networks. Please note the following when using ETHERNET products in your system:

- Do not connect control components and control networks to an open network such as the Internet or an office network.
WAGO recommends putting control components and control networks behind a fire-wall.
- In the control components, close all ports and services (e.g., for WAGO-I/O-CHECK and CODESYS) not required by your application to minimize the risk of cyber attacks and to enhance cybersecurity.
Only open the ports and services for the duration of the commissioning/configuration.
- Limit physical and electronic access to all automation components to authorized personnel only.
- To reduce the risk of unauthorized access to your system, change the default passwords before initial commissioning.
- To reduce the risk of unauthorized access to your system, regularly change the passwords used.
- To verify that the measures taken meet your security requirements, regularly perform threat analyses.
- To restrict access to and control of individual products and networks, employ a “defense-in-depth” mechanism in your system’s security configuration.

Additional documents

-  [Manual Cybersecurity for PFC100 / PFC200 Controllers](#)
-  [White Paper Cybersecurity in Production Facilities](#)

All the documentation and information is available at: www.wago.com.

Use of Cloud Services

Note

Please note the risks of using cloud services!

If you use third-party cloud services, sensitive data is transferred to the cloud service provider on your own responsibility. External access may result in manipulated data and/or unwanted control commands affecting the performance of your control system.

- Use encryption methods to protect your data.
- Observe the information provided by the Federal Office for Information Security – “Cloud: Risks and Security Tips.”
- Observe comparable publications of the responsible authorities of your country.

Additional information is available at: www.bsi.bund.de.

5.3 Designing the System Supply

Designing the system supply requires knowledge of the entire system-side current consumption of the installed I/O modules.

An additional system power supply must be used if:

- The total system-side power consumption exceeds the maximum permissible total current of the system supply

Do not exceed the maximum total current for I/O modules via data contacts! The data contacts for internal system supply can be damaged and the permissible operating temperature can be exceeded by higher values.

You can find product-specific information on “Total Current for System Supply” and “Current Consumption of System Supply (5 V)” in the technical data of the corresponding  **Product Manual**.

For fast, effortless supply design, use the WAGO Configurator Smart Designer.

A calculation example is available at:  [Examples and Aids \[▶ 42\]](#)

5.4 Field Supply Layout

Designing the field supply requires knowledge of the entire field-side current consumption of the installed I/O modules. The field-side current consumption of an I/O module consists of:

- Demand from the field-side I/O module electronics
- Possible output currents of the I/O modules used

You can find product-specific information on “Current Carrying Capacity of the Power Jumper Contacts” and “Current Consumption of the Field Supply (Module without External Load)” in the technical data of the corresponding  **Product Manual**.

More power must be provided through an additional supply module if:

- The maximum permissible total current of the field power supply is reached
- The maximum permissible total current of the power jumper contacts is reached
- The I/O module positioned to the left in the sequence does not pass on the required potential

Do not exceed maximum total current for I/O modules via power contacts! The current carrying capacity of the power jumper contacts is 10 A. The power jumper contacts for the internal field supply can be damaged and the permissible operating temperature can be exceeded by higher values.

For fast, effortless supply design, use the WAGO Configurator Smart Designer.

A calculation example is available at:  [Examples and Aids \[▶ 42\]](#)

5.5 Special Applications and Environments

5.5.1 Marine and Offshore

The node structure must meet additional requirements to qualify for certified marine applications.

If these requirements are specific to an I/O module, they are described in the respective  **Product Manual**. Otherwise, the following general requirements for marine applications apply.

A filter module must be used for each system and field supply infeed point with a nominal voltage of 24 VDC:

- Use a supply filter (750-626/xxx-xxx) for the system supply.
- Use a filter module for field-side power supply (750-624/xxx-xxx) or a supply filter (750-626/xxx-xxx) for the field supply.

No additional filter module is required for field supply with a nominal value different from 24 VDC.

No filter module is required for field supply different from 24 VDC.

Marine Applications per DNV

- Class A: all areas except bridge and open deck
- Class B: all areas including bridge and open deck

Applications with Isolation Monitoring

High-isolation (HI) versions of the filter modules are required for applications with isolation monitoring.

Table 7: High-Isolation Filter Modules

High-Isolation Filter Modules	
Field-side power supply filters	Supply filter, 24 VDC, HI (750-624/020-000)
	Filter module, 24 VDC, HI, no power jumper contacts (750-624/020-001)
	Supply filter, 24 VDC, HI, with ground fault diagnostics (750-624/020-002)
Filter modules	Supply filter, 24 VDC, HI (750-626/020-000)
	Supply filter, 24 VDC, HI, with ground fault diagnostics (750-626/020-002)
	Supply filter, 24 VDC, HI/T (750-626/025-001)

Example of a Power Supply Concept for Marine Applications – Classes A and B per DNV

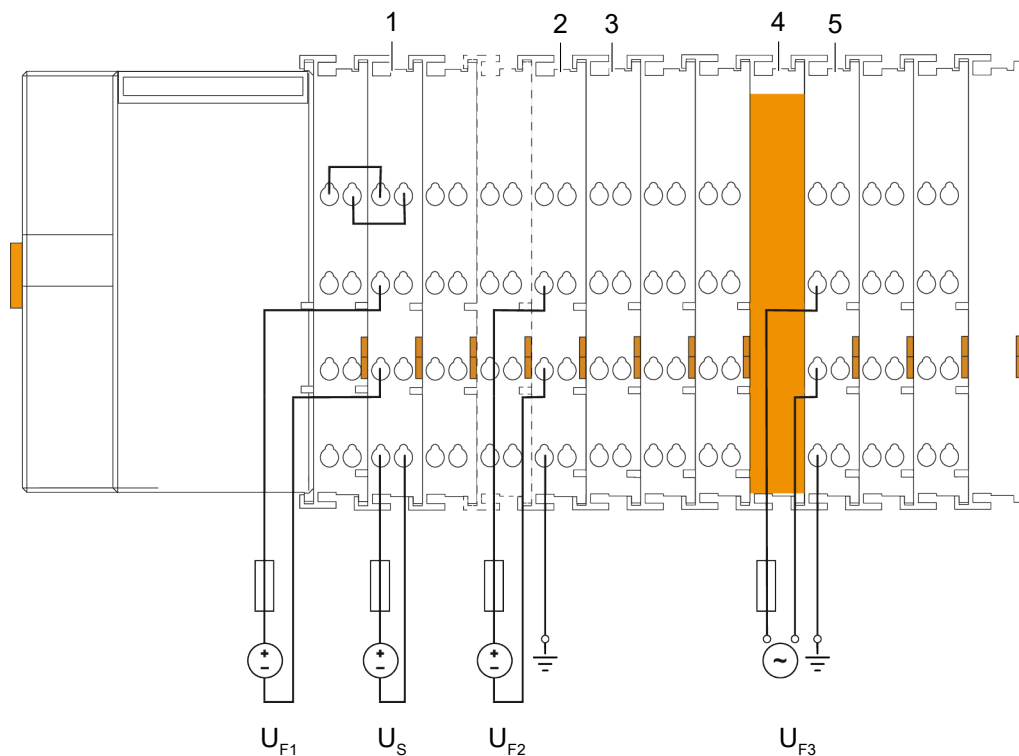

Figure 17: Power Supply Concept for Marine Applications – Classes A and B

1	Supply filter, 24 VDC, HI GF (750-626/020-002) or Supply filter, 24 VDC, HI (750-626/020-000) or Supply filter, 24 VDC, HI / T (750-626/025-001)
2	Power supply, 24 VDC (750-602) or Power supply, 24 VDC, with fuse (750-601) or Power supply, 24 VDC, with fuse and diagnostics (750-610)

3	Filter module for field-side power supply, 24 VDC, HI GF (750-624/020-002) or Filter module for field-side power supply, 24 VDC, HI (750-624/020-000)
4	Distance module, 24 VDC / 230 VAC (750-616/030-000)
5	Power supply, 230 VAC/DC, with diagnostics, with fuse holder (750-611) or Power supply, 230 VAC/DC, without diagnostics, with fuse holder (750-609) or Power supply, 230 VAC/DC, without diagnostics, without fuse holder (750-612)
U_S	System supply (24 VDC)
U_{F1}	Field supply 1 (24 VDC)
U_{F2}	Field supply 2 (24 VDC)
U_{F3}	Field supply 3 (230 VAC)

Power Supply with FE Power Jumper Contact

If an FE power contact is required after the supply filter (750-626/xxx-xxx), an additional supply module is required after the supply filter. For this purpose, the field supply from the supply filter (750-626/xxx-xxx) must be bridged to the supply module.

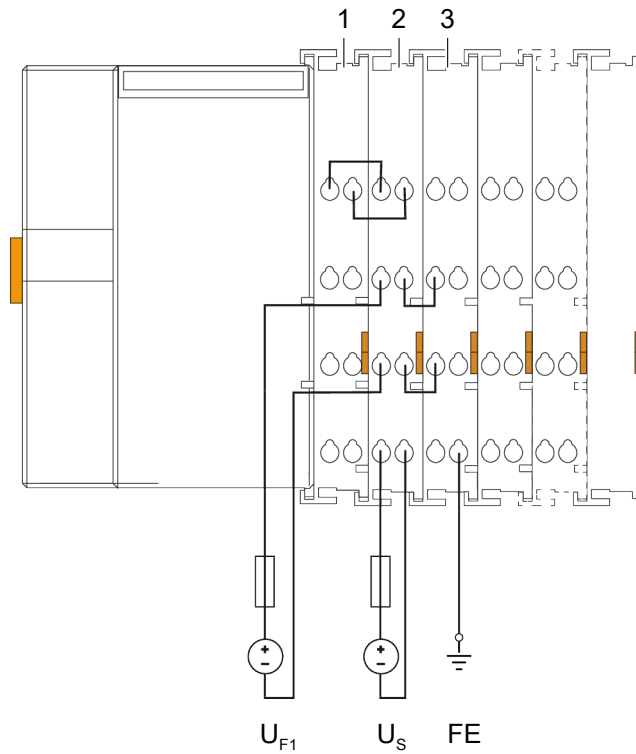

Figure 18: Power Supply Concept for Marine Applications – Classes A and B with FE Power Jumper Contact

1	Head station
2	Supply filter, 24 VDC, HI GF (750-626/020-002) or Supply filter, 24 VDC, HI (750-626/020-000) or Supply filter, 24 VDC, HI / T (750-626/025-001)
3	Power supply, 24 VDC (750-602) or Power supply, 24 VDC, with fuse (750-601) or Power supply, 24 VDC, with fuse and diagnostics (750-610)
U_S	System supply (24 VDC)
U_{F1}	Field supply 1 (24 VDC)
FE	Functional ground

5.5.2 Ex i Applications

Some I/O modules are intended to be connected with devices located in hazardous areas. To ensure safety and reliability in these applications, several additional requirements must be considered:

- The node structure meets the additional requirements specified below for the power supply as well as the requirements for air and creepage distances.
- The operator obtains a prototype test certificate that confirms the correct installation of the system and store it in a control cabinet or housing.

Observe the detailed requirements as stated in the original wording of the respective certificate (Installation Regulations Specified by Approvals).

Power Supply Requirements

Only Ex i bus supply modules are permitted to be used for power supply to any node sections containing I/O modules for Ex i applications.

The following Ex i potential supply modules may be used for this purpose: 750-606, 750-625/000-001.

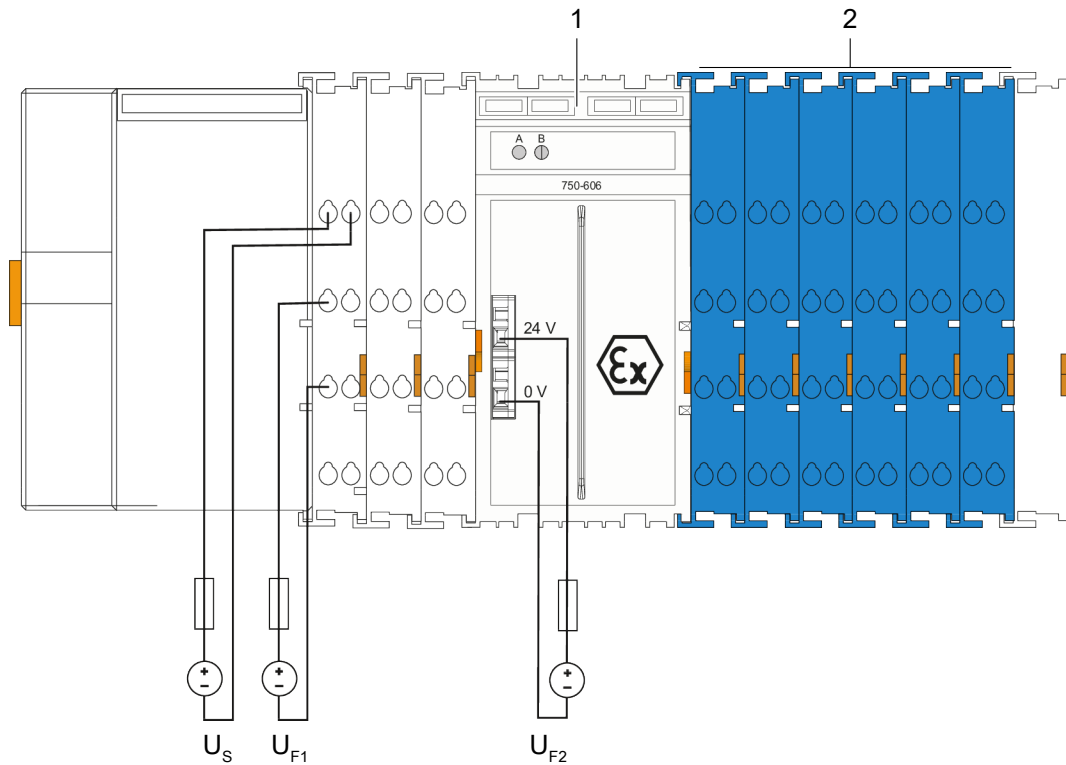

Figure 19: Ex i Power Supply Concept

1	Ex i bus supply module (750-606, 750-625/000-001)*
2	Ex i I/O modules
U_S	System supply (24 VDC)
U_{F1}	Field supply 1 (24 VDC)
U_{F2}	Field supply 2 (24 VDC)

*)
 750-606 with electronic fuse and diagnostics
 750-625/000-001 with electronic fuse and no diagnostics

Clearance and Creepage Distance Requirements

For all sections of a node that contain I/O modules for Ex i use, stricter requirements regarding clearances and creepage distances apply. Before the first such node section, the respective **Ex i supply module** (750-606 or 750-625/000-001) ensures the required distance.

After each such node section, **four distance modules** (750-616) must be used. This also applies when the next section also starts with an **Ex i supply module** (750-606 or 750-625/000-001).

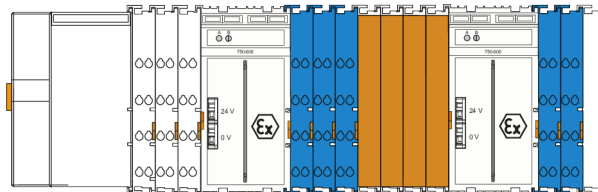

Exceptions:

If the following section consists of an **end module for bus extension** (750-627), **one distance module** (750-616) is sufficient.

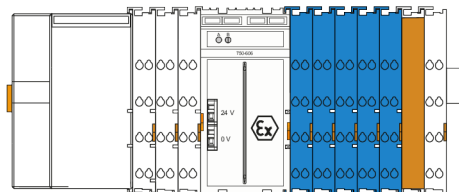

If the following section consists of one **end module** (750-600), no distance modules are required.

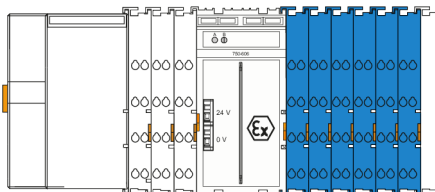

5.5.3 Marine and Offshore Ex i Applications

When I/O modules are used in marine Ex i applications, additional requirements must be considered alongside those described under [Ex i Applications \[▶ 38\]](#) Ex i.

Power Supply Concept for Marine Applications in Ex i Zone, Class A

To use intrinsically safe modules Class A marine applications (all areas, except bridge and open deck), the filter module 750-624/xxx-xxx must be used in conjunction with the Ex i supply module.

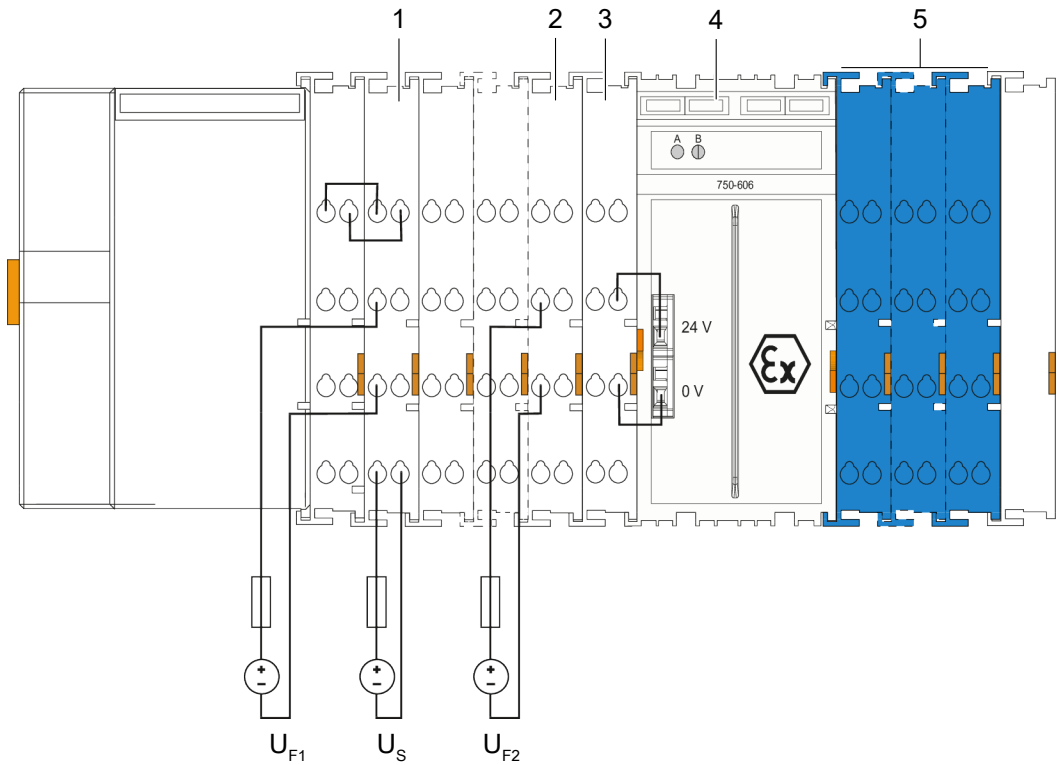

Figure 20: Power Supply Concept for Marine Applications in Ex i Zone – Class A

1	Filter module, 24 VDC, HI GF (750-626/020-002) or filter module, 24 VDC, HI (750-626/020-000)
2	Bus supply module, 24 VDC (750-602) or bus supply module, 24 VDC, with fuse (750-601) or bus supply module, 24 VDC, with fuse and diagnostics (750-610)
3	Filter module, 24 VDC, HI GF (750-624/020-002) or filter module, 24 VDC, HI (750-624/020-000)
4	Bus supply module, 24 VDC, Ex i, with diagnostics (750-606) or bus supply module, 24 VDC, Ex i (750-625/000-001)
5	Ex i I/O modules

Power Supply Concept for Marine Applications in Ex i Zone, Class B

To use intrinsically safe modules Class B marine applications (all areas, except bridge and open deck), the filter module 750-626/xxx-xxx must be used in conjunction with the Ex i supply module.

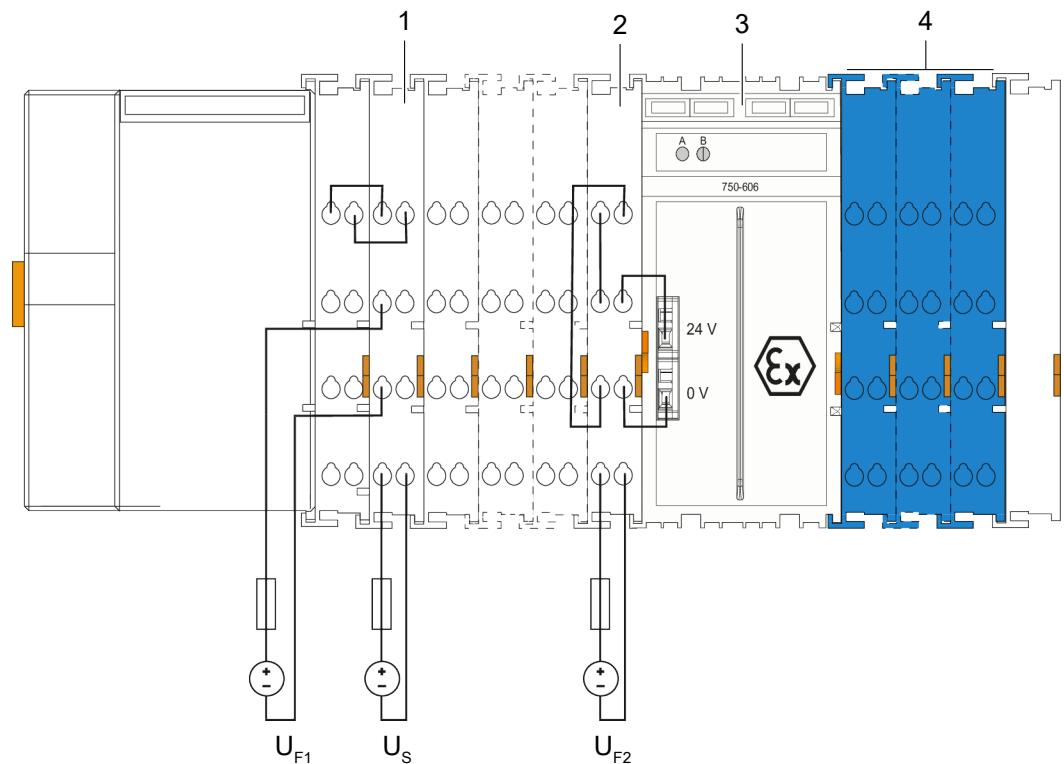

Figure 21: Power Supply Concept for Marine Applications in Ex i Zone – Class B

1	Filter module, 24 VDC, HI GF (750-626/020-002) or filter module, 24 VDC, HI (750-626/020-000)
2	Filter module, 24 VDC, HI GF (750-626/020-002) or filter module, 24 VDC, HI (750-626/020-000)
3	Bus supply module, 24 VDC, Ex i, with diagnostics (750-606) or bus supply module, 24 VDC, Ex i (750-625/000-001)
4	Ex i I/O modules

5.5.4 Functional Safety

5.5.4.1 Power Supply Concept

When using F I/O modules, the system and field supply must be protected against surge voltages (burst and surge) in accordance with EN 61326-3-1.

If these requirements are specific to an I/O module, they are described in the respective **Product Manual**. Otherwise, the following general requirements apply.

A filter module must be used for each system and field supply input point with a nominal voltage of 24 VDC:

- Use a power supply filter (750-626/xxx-xxx) for the system supply.
- Use a field supply filter (750-624/xxx-xxx) or a power supply filter (750-626/xxx-xxx) for the field supply.

Power Supply Concept Example

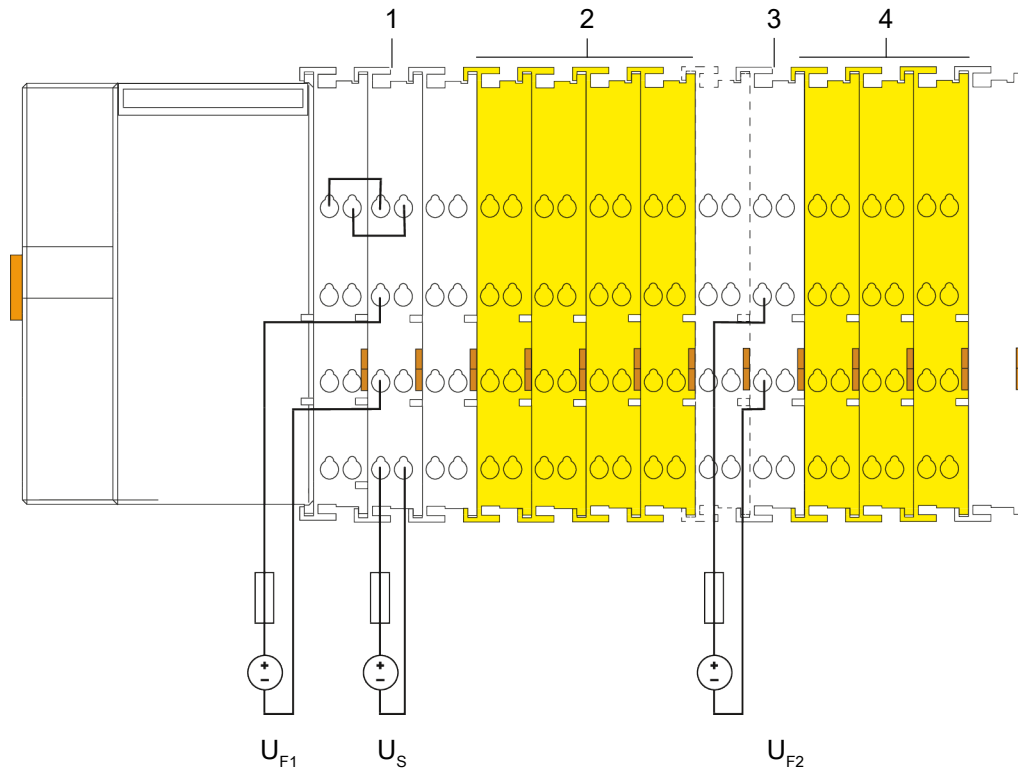

Figure 22: Power Supply Concept Example with F I/O-Modules

1	Filter module, 24 VDC, (750-626/xxx-xxx)
2	F I/O modules
3	Filter module, 24 VDC, (750-624/000-001)
4	F I/O modules
U_S	System supply (24 VDC)
U_{F1}	Field supply 1 (24 VDC)
U_{F2}	Field supply 2 (24 VDC)

5.6 Examples and Aids

5.6.1 Aids

WAGO can help you with a wide range of useful products and software solutions. The aids for project planning include:

- **e!COCKPIT**
e!COCKPIT is an integrated development environment that supports every automation task, from hardware configuration and programming, to simulation and visualization, to commissioning – an all-in-one software package.
- **WAGO Smart Designer Configurator**
The **Smart Designer** configurator enables true 3D configuration of WAGO’s electrical interconnect and automation components, including the WAGO-I/O-SYSTEM 750/753, circuit boards and terminal blocks. With this tool you can, among other things, configure a node of the I/O system and calculate the approximate power requirement.
- **WAGO-I/O-CHECK**
Application for operating and displaying a node consisting of components of the 750/753 and 750 XTR WAGO I/O Systems.

Coding

Multi-part I/O modules from the WAGO I/O-System can be equipped with coding keys to prevent mismatching when connecting the individual module parts.

For additional information see: Assembling/Disassembling Components.

System Supply Power Requirement: Example Calculation

The example calculation is based on the following node structure:

- Head station
- 5 × 16-channel digital input module
- 5 × 16-channel digital output module
- 11 × 8-channel analog input module
- 10 × 8-channel analog output module
- 2 × relay module
- I/O module ...

Table 8: Power Requirement: Example Calculation

Head station	1,700 mA
5 × 16-channel digital input module (25 mA)	- 125 mA
5 × 16-channel digital output module (40 mA)	- 200 mA
11 × 8-channel analog input module (69 mA)	- 759 mA
10 × 8-channel analog output module (61 mA)	- 610 mA
Remaining total system supply current At this point, an additional supply module must be used!	6 mA
Supply module	2,000 mA
2 × relay module (100 mA)	- 200 mA
I/O module ...	- ...

Field Supply Power Requirement: Example Calculation

The field supply layout must be handled in a similar manner as the system supply. In addition, power requirements for external actuators and sensors must be taken into account. Additional supply modules may be needed. Detailed product information is available in the respective  **Product Manual**.

Determining Power Loss

Power loss depends on the node structure and the applied field signals. To roughly determine power loss, use:

- Head station: 3 W
- I/O module: 1 W

5.6.2 I/O Test

The WAGO I/O System allows easy, effective testing of your wiring with an I/O test.

For example, WAGO software solutions such as **e!COCKPIT** and **WAGO-I/O-CHECK** make it possible to:

- Switch inputs and outputs
- Display digital input states
- Display analog input values
- Output analog values

Detailed instructions are available in the  product manuals for **e!COCKPIT** and **WAGO-I/O-CHECK**.

Transport and Storage

The original packaging offers optimal protection during transport and storage.

- Store the products in suitable packaging; preferably, in the original packaging.
- Only transport the products in suitable containers/packaging.
- Make sure the product contacts are not contaminated or damaged when packing or unpacking.
- Observe the specified ambient climatic conditions for transport and storage of the products.

Assembly and Disassembly

Note

Assembly must be preceded by professional planning!

Before you assemble an I/O System node, make sure that the intended assembly follows all safety precautions and planning instructions in this documentation.

The following information must be provided:

- Information about the correct node structure
- Information about permissible mechanical, electrical and climatic ambient conditions
- Circuit diagrams
- Mounting position, clearances, cable types and lengths

7.1 Warning Messages for Assembly and Disassembly

WARNING

Accidental Contact with Hazardous Active Voltage!

When voltage is hazardous active, accidental contact may result in an electric shock.

1. Always disconnect all voltages from the system before starting work on the system!
2. Make sure the system do not carry any voltage!

7.2 Assembly Sequence

The components of the I/O system must be snapped directly onto a DIN-rail. Starting with the head station, the I/O modules must be installed from left to right according to the project design, in the nominal mounting position.

7.3 Snapping the Head Station to the DIN-Rail

1. Snap the head station onto the DIN-rail.
2. To attach the head station to the DIN-rail, use an operating tool to turn the DIN-rail locking cam until the nose of the DIN-rail locking cam engages behind the DIN-rail.

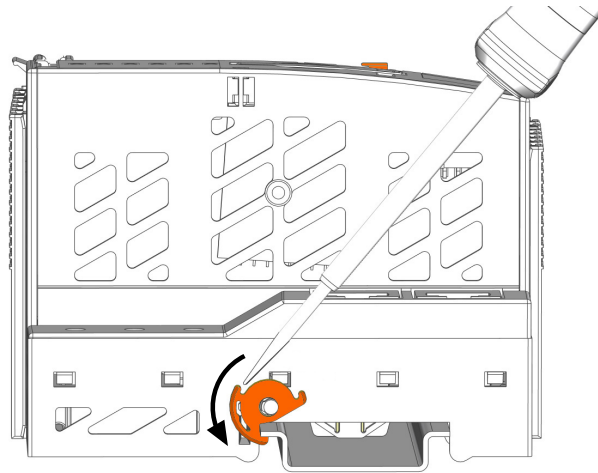

Figure 23: Locking the Head Station

⇒ The head station is now locked on the DIN-rail.

7.4 Attaching an I/O Module

1. Position the I/O module in such a way that the groove and spring are connected to the preceding and, if applicable, the following components.

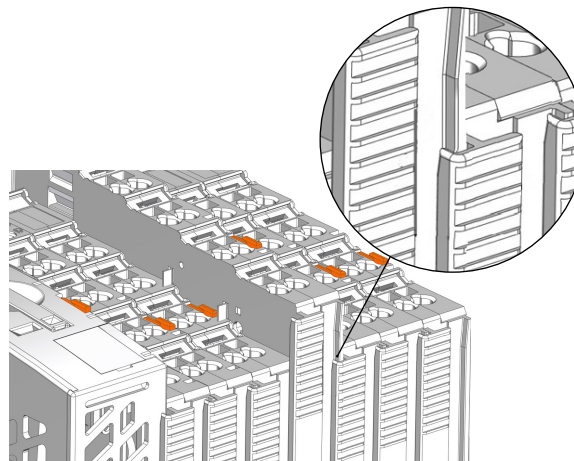

Figure 24: Inserting the I/O Module

2. Press the I/O module into the assembly until the I/O module snaps onto the DIN-rail.

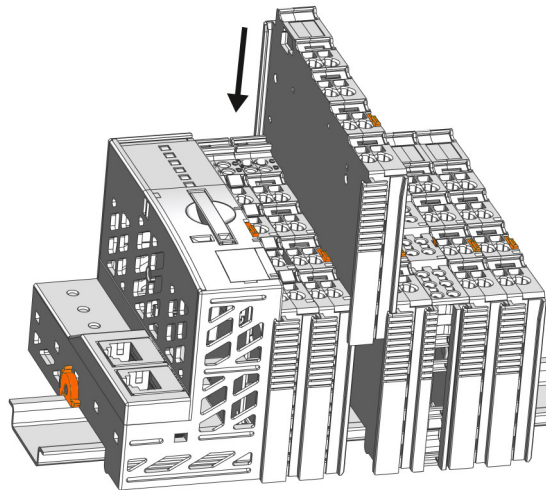

Figure 25: Snapping the I/O Module On

3. Check that the I/O module is seated securely on the DIN-rail and in the assembly.
 - ⇒ Once the I/O module has snapped into place, the electrical connections are established for the data contacts and power contacts (if any) to the head station or to the preceding and, if applicable, following I/O module.

Adding the Wiring Interface of the 753 Series

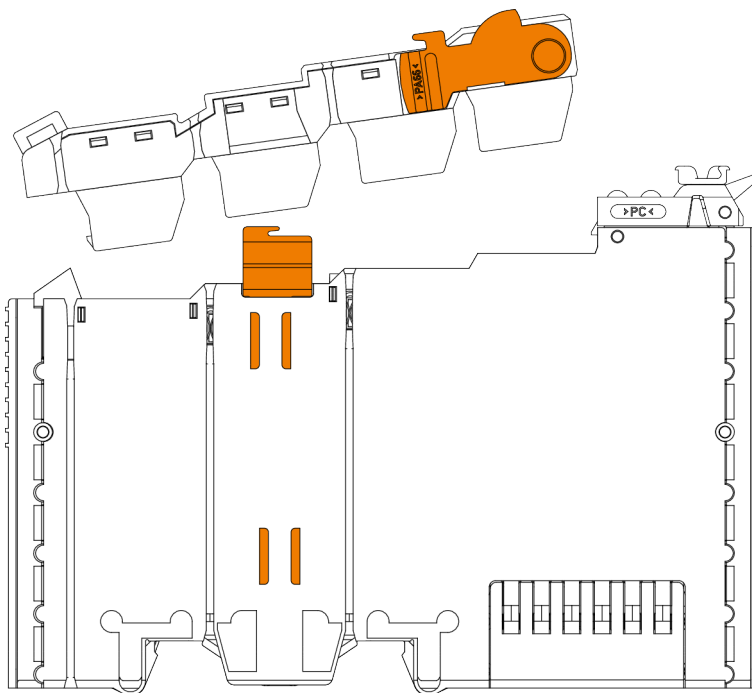

Figure 26: 753 Series Wiring Interface and I/O Module

1. Make sure that the locking tab of the I/O module is not pulled out.
2. Place the wiring interface on the I/O module.
3. Press the wiring interface onto the I/O module until it clicks into place completely.

7.5 Removing a Head Station from the DIN-Rail

Follow these steps to remove a head station from a DIN-rail:

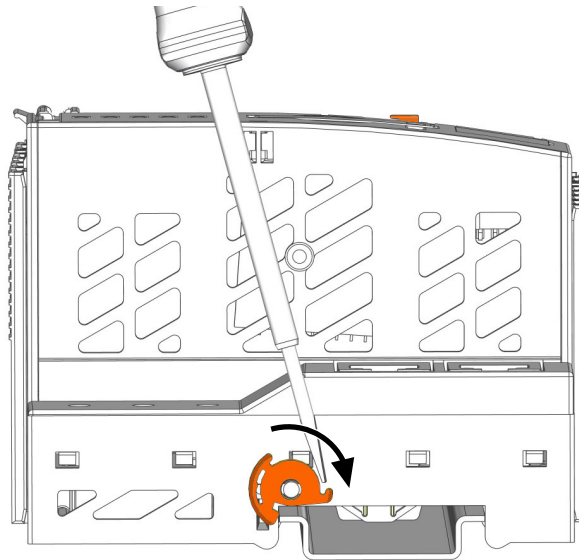

Figure 27: Disengage the locking cam

1. Use an operating tool to turn the DIN-rail locking cam until the nose of the DIN-rail locking cam disengages from the DIN-rail.
 2. Use the release tab to pull the head station off the DIN-rail and, if necessary, out of the assembly. To remove head stations with two release tabs, both tabs must be pulled at the same time!
- ⇒ When the head station is pulled out of an assembly, the electrical connections of the data contacts or power jumper contacts to the subsequent I/O module are separated.

7.6 Removing an I/O Module

An I/O module can be detached from the DIN-rail with the help of its release tab and pulled out of the assembly.

⚠ CAUTION

Risk of injury due to sharp-edged power jumper contacts!

Removing the products in a careless manner can cause cuts.

- When removing the products, pay attention to the power jumper contacts!

Removing 750 Series I/O Modules

1. Pull the orange release tab on the I/O module upwards. To remove I/O modules with two release tabs from an assembly, both tabs must be pulled at the same time!

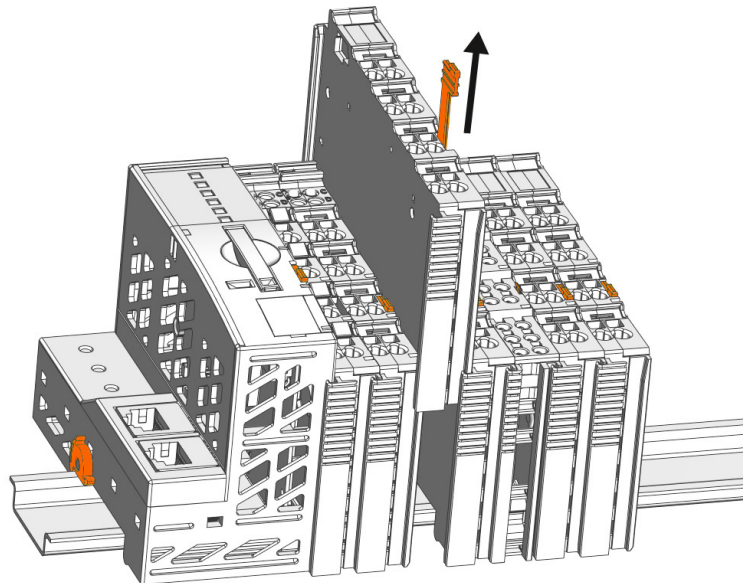

Figure 28: Pulling the Release Tab

2. Pull the I/O module out of the assembly by the release tab.
 - ⇒ When the I/O module is pulled out of the assembly, the electrical connections of the data and power contacts are disconnected.

Removing 753 Series I/O Modules

1. Remove the pluggable connector by pulling the orange locking latch towards the top edge of the I/O module.
 - ⇒ The release tab is then accessible.

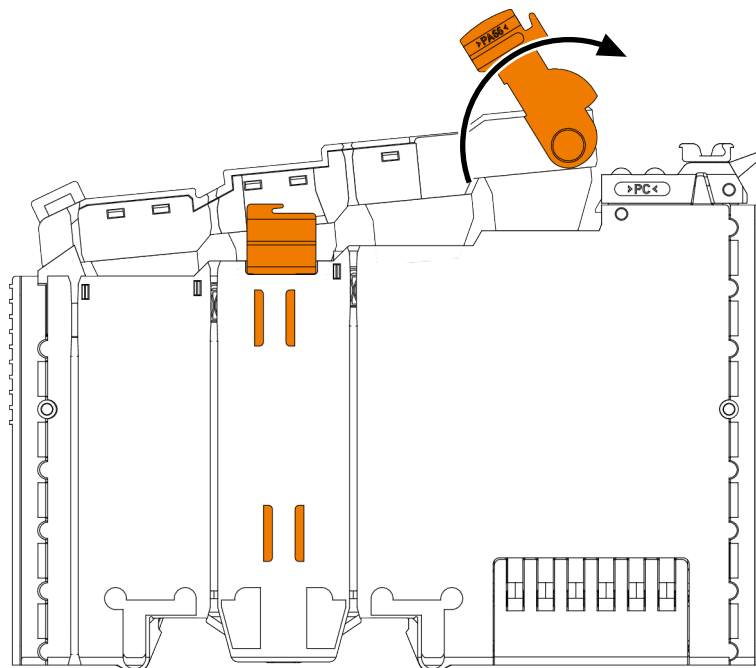

Figure 29: Pulling the Locking Latch

2. Pull up the orange release tab on the I/O module.

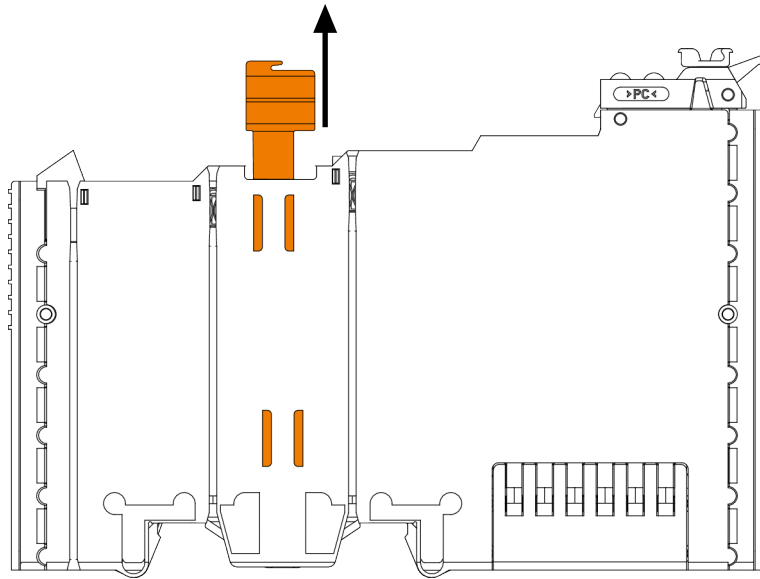

Figure 30: Detaching the 753 Series I/O Module

3. Pull the I/O module out of the assembly by the release tab.
 - ⇒ When the I/O module is pulled out of the assembly, the electrical connections of the data and power contacts are separated.

7.7 Inserting Coding Keys

For 753 Series I/O modules, the connection between the I/O module and the pluggable connector can be coded. For the coding, proceed as follows:

1. Insert the pin into the socket.

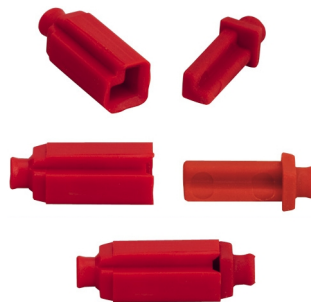

Figure 31: Putting the Coding Keys Together

2. Position the assembled coding keys in the I/O module.

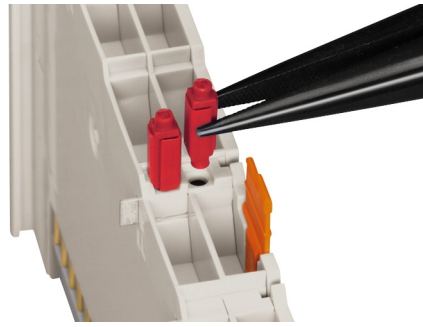

Figure 32: Inserting Coding Keys

⇒ Due to its design, each coding pin allows four different coding options (i.e.; 16 different options using two coding keys).

3. Put the pluggable connector on the I/O module.



Figure 33: Plugging the Connector into Place

⇒ After removing the pluggable connector, the sockets remain in the I/O module.



Figure 34: Coding Keys for Clear Assignment

Conductor Termination

8.1 Conductor Termination

CAGE CLAMP®- and Push-in CAGE CLAMP® Connectors are designed for solid, stranded and fine-stranded conductors.

Only one conductor may be connected to each clamping unit.

8.1.1 Connecting Conductors to CAGE CLAMP®

To connect the conductor, an operating tool must be used to open the CAGE CLAMP®.

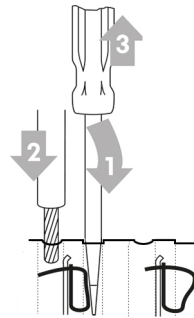

Figure 35: Connecting a Conductor to a CAGE CLAMP®

To connect a conductor, proceed as follows:

- ✓ You need an operating tool.
 - 1. Insert the operating tool straight into the rectangular opening above the connection to open the CAGE CLAMP®.
 - 2. Insert the conductor into the corresponding connection opening (round housing opening).
 - 3. Remove the operating tool again to close CAGE CLAMP®.
- ⇒ The conductor is now securely clamped.

8.1.2 Connecting Conductors to Push-in CAGE CLAMP®

Stranded and fine-stranded conductors with ferrules, as well as solid conductors can be plugged directly into

Push-in CAGE CLAMP® Connectors.

For all other conductor types, an operating tool must be used to open the Push-in CAGE CLAMP®.

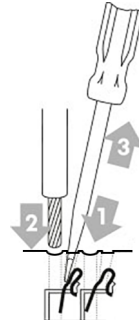

Figure 36: Connecting Conductor to Push-in CAGE CLAMP®

To open a Push-in CAGE CLAMP® Connector, proceed as follows:

- ✓ You need an operating tool.
 - 1. Insert the operating tool at an angle into the rectangular opening above the connection to open the CAGE CLAMP®.
 - 2. Insert the conductor into the corresponding connection opening (round housing opening).
 - 3. Remove the operating tool again to close the Push-in CAGE CLAMP®.
- ⇒ The conductor is now securely clamped.

Decommissioning

9.1 Shutting Down

1. Bring the process to a secure stop.
 2. Disconnect the respective system component from the power supply.
 3. Check if the voltage is isolated.
 4. Protect the system component from accidental or unauthorized restart.
 5. Switch off any system and/or field supply to the node that is still connected. The order has no effect.
- ⇒ The node does not carry any power and the product can be dismantled ([🔧 Assembly and Disassembly \[▶ 46\]](#)).

9.2 Disposal and Recycling

	<p>WEEE Mark</p> <p>Electrical and electronic equipment may not be disposed of with household waste. This also applies to products without this mark.</p>
---	--

Electrical and electronic equipment contain materials and substances that can be harmful to the environment and health. Electrical and electronic equipment must be disposed of properly after use. Environmentally friendly disposal benefits health, protects the environment from harmful substances in electrical and electronic equipment and enables sustainable and efficient use of resources.

- Observe the national and local regulations for the disposal of electrical and electronic equipment, lithium-ion batteries, lead–acid batteries and packaging.
- Clear any data stored on electrical and electronic equipment.
- Remove lithium-ion batteries, lead–acid batteries or memory cards that are added to the electrical and electronic equipment.
- Wear appropriate personal protective equipment when removing the lithium-ion batteries/lead–acid batteries.
- Dispose of the removed lithium-ion batteries/lead–acid batteries according to your local waste regulations (e. g. collection boxes at the retail or local collection points).
- Have electrical and electronic equipment sent to a local collection point.
- Dispose of all types of packaging to ensure a high level of recovery, reuse and recycling.
- Transport packages from the B2B area can be taken back free of charge via a return system in accordance with the Packaging Act. Please contact our service provider Interseroh directly. The corresponding certificate can be found at: [🌐 corporate-certificates](#)
- Throughout Europe, Directives 2006/66/EC, 94/62/EC and 2012/19/EU (WEEE) apply. National directives and laws may differ.

Appendix

10.1 Installation Regulations Specified by Approvals

10.1.1 Special Notes Regarding Explosion Protection

The following warning notices are to be posted in the immediate proximity of the product (WAGO I/O System 750/753):

- **WARNING – DO NOT REMOVE OR REPLACE FUSED WHILE ENERGIZED!**
- **WARNING – DO NOT DISCONNECT WHILE ENERGIZED!**
- **WARNING – ONLY DISCONNECT IN A NON-HAZARDOUS AREA!**

Before using the components, check whether the intended application is permitted in accordance with the respective printing. Pay attention to any changes to the printing when replacing components.

The product is open type equipment. As such, the product must only be installed in appropriate enclosures or electrical operation rooms to which the following applies:

- Can only be opened using a tool or key.
- Inside pollution degree 1 or 2.
- In operation, internal air temperature within the highest minimum value and lowest maximum value of the permissible surrounding air temperature of all components
- Minimum degree of protection: min. IP54 (acc. to EN/IEC 60529)
- For use in Zone 2 (Gc), compliance with the applicable requirements of the standards EN/IEC/ABNT NBR IEC 60079-0, -11, -15
- For use in Zone 22 (Dc), compliance with the applicable requirements of the standards EN/IEC/ABNT NBR IEC 60079-0, -11, -15 and -31
- For use in mining (Mb), minimum degree of protection IP64 (acc. EN/IEC 60529) and adequate protection acc. EN/IEC/ABNT NBR IEC 60079-0 and -1
- Depending on zoning and device category, correct installation and compliance with requirements must be assessed and certified by a "Notified Body" (ExNB) if necessary!

Explosive atmosphere occurring simultaneously with assembly, installation or repair work must be ruled out. Among other things, these include the following activities:

- Insertion and removal of components
- Connecting or disconnecting from fieldbus, antenna, D-Sub, ETHERNET or USB connections, DVI ports, memory cards, configuration and programming interfaces in general and service interface in particular
- Operating DIP switches, coding switches or potentiometers
- Replacing fuses

Wiring (connecting or disconnecting) of non-intrinsically safe circuits is only permitted in the following cases:

- The circuit is disconnected from the power supply.
- The area is known to be non-hazardous.

Outside the device, suitable measures must be taken so that the rated voltage is not exceeded by more than 40 % due to transient faults (e.g., when powering the field supply).

Product components intended for intrinsically safe applications may only be powered by supply modules which are intended for intrinsically safe applications themselves.

Only field devices whose power supply corresponds to overvoltage category I or II may be connected to these components.

10.1.2 UL Requirements from Installation Regulations

10.1.2.1 UL Ordinary Locations per Report Reference E175199-19970402

Note

Valid Installation Regulations

The underlying installation regulations are covered by the instruction leaflet and the product manuals at the time of manufacture prior to July 4, 2014.

Because the following information refers to language-specific regulations, standards or certifications applicable to the specific installation and operation location, it is presented in the respective original language.

Installation instructions revised on 2014-07-04

For cULus examination, the WAGO I/O System Series 750, 753 and 758 s have only been investigated for risk of fire and electrical shock (in accordance with UL508 and CSA C22.2 No. 142).

For devices with EtherCAT/Ethernet connectors:

- Only for use in LAN, not for connection to telecommunication circuits

For devices 750-1400, 750-1402, 750-1500, 750-1501 and 750-1502:

- Connection shall be made with R/C (ECBT2) Type 612-230, manufactured by Wuerth Elektronik Eisos GmbH & Co KG, rated 150°C provided with R/C (AVLV2) Style 2464, rated 300 V, 80°C.

10.1.2.2 UL Ordinary Locations per Report Reference E175199-20180807

Note

Valid Installation Regulations

The underlying installation regulations are covered by the instruction leaflet and the product manuals at the time of manufacture prior to August 19, 2022.

Because the following information refers to language-specific regulations, standards or certifications applicable to the specific installation and operation location, it is presented in the respective original language.

Manual statements revised on 2022-08-19

For Bus coupler, Bus controller for 24V system supply input voltage an external fuse, rated max. 2A, slow acting, min. 30Vdc shall be used.

For field supplied Module (also supplied by Power jumper contacts) for 24V field supply input voltage an external fuse, rated max. 10A, slow acting, min. 30Vdc shall be used.

For field supplied Module (also supplied by Power jumper contacts) with field supply input voltage up to 250Vac/Vdc an external fuse, rated max. 10A, slow acting, related to the appropriate voltage shall be used.

For products Module Nos. 750-750-495, 750-495/000-001 750-495/000-002, 750-495/040-000, 750-495/040-001, 750-495/040-002 for Voltage measurement inputs Three-phase, three-wire system: 600 Vac:

The Neutral shall not be connected. Neutral conductors as part of the mains circuit, shall be considered hazardous live. No PI in Neutral provided.

With distance module mounting (eg. Module Nos. 750-616) with a width of 12 mm. Additional Supplementary insulation shall be provided.

For Models 750-439/040-000, 750-481/040-000, 750-484/040-000, 750-486/040-000, 750-489, 750-535/040-000, 750-585/040-000, 750-586/040-000, and 750-633/040-000:

Shall only be operated with a power supply 24 Vdc Diagn for Ex I XTR Modules 750-606/040-000.

10.1.2.3 UL Ordinary Locations per Report Reference E175199-20181019

Note

Valid Installation Regulations

The underlying installation regulations are covered by the instruction leaflet and the product manuals at the time of manufacture prior to August 19, 2022.

Because the following information refers to language-specific regulations, standards or certifications applicable to the specific installation and operation location, it is presented in the respective original language.

Manual statements revised on 2022-07-12

For Bus coupler, Bus controller for 24V system supply input voltage an external fuse, rated max. 2A, slow acting, min. 30Vdc shall be used.

For field supplied Module (also supplied by Power jumper contacts) for 24V field supply input voltage an external fuse, rated max. 10A, slow acting, min. 30Vdc shall be used.

For Module No. 750-8211, 750-8211/040-000, 750-8211/040-001:

These devices are to be used with Optical Transceivers / SFP modules as prescribed in the Installation instructions of WAGO. Such SFP modules need to be in compliance with Laser Class I in accordance with 21 CFR 1040 and rated max. 1 W Neutral shall not be connected. Neutral conductors as part of the mains circuit, shall be considered hazardous live. No PI in Neutral provided.

10.1.2.4 UL Ordinary Locations per Report Reference E175199-20210716

Because the following information refers to language-specific regulations, standards or certifications applicable to the specific installation and operation location, it is presented in the respective original language.

Manual statements issued on 2021-07-16

For Bus coupler, Bus controller for 24V system supply input voltage an external fuse, rated max. 2A, slow acting, min. 30Vdc shall be used.

For field supplied Module (also supplied by Power jumper contacts) for 24V field supply input voltage an external fuse, rated max. 10A, slow acting, min. 30Vdc shall be used.

10.1.2.5 UL Ordinary Locations per Report Reference E175199-20230421

Because the following information refers to language-specific regulations, standards or certifications applicable to the specific installation and operation location, it is presented in the respective original language.

Manual statements issued on 2023-04-21

For Bus coupler, Bus controller for 24V system supply input voltage an external fuse, rated max. 2A, slow acting, min. 30Vdc shall be used.

For field supplied Module (also supplied by Power jumper contacts) for 24V field supply input voltage an external fuse, rated max. 10A, slow acting, min. 30Vdc shall be used.

10.1.2.6 UL Hazardous Locations per Report Reference E198726-19980911** Note****Valid Installation Regulations**

The underlying installation regulations are covered by the instruction leaflet and the product manuals at the time of manufacture prior to August 19, 2022.

Because the following information refers to language-specific regulations, standards or certifications applicable to the specific installation and operation location, it is presented in the respective original language.

Installation and operating instructions revised on 2022-12-08

This equipment is suitable for use in Class I, Division 2, Groups A, B, C and D Or nonhazardous locations only.

This equipment is to be fitted within tool-secured enclosures only.

English	French
WARNING - EXPLOSION HAZARD - SUBSTITUTION OF COMPONENTS MAY IMPAIR SUITABILITY FOR CLASS I, DIV. 2.	ATTENTION – DANGER D'EXPLOSION – L'ÉCHANGE DE COMPOSANTS PEUT ALTÉRER L'APTITUDE DE CLASSE I, DIV. 2.

Applicable for each operator accessible connector and fuse holder:

English	French
WARNING - DO NOT DISCONNECT EQUIPMENT UNLESS POWER HAS BEEN SWITCHED OFF OR THE AREA IS KNOWN TO BE NON-HAZARDOUS	ATTENTION – NE DÉBRANCHER L'APPAREIL QU'EN L'ABSENCE DE COURANT OU LORSQUE LA ZONE EST CONSIDÉRÉE SANS RISQUE D'EXPLOSION.

WARNING - USE MODULE 750-642 ONLY WITH ANTENNA MODULE 758 -910	AVERTISSEMENT : UTILISEZ LE MODULE RÉF. 750-642 UNIQUEMENT AVEC LE MODULE D'ANTENNE RÉF. 758-910 !
--	--

Module 750-538 only

Manual shall contain CONTROL DRAWING No.750538 with its entity parameters. "In Hazardous Locations, Non-Incendive only when installed per Control Drawing No. 750538"

The Modules 750-439, 0750-0486, 750-538, 0750-0539, 750-633, 750-663/000-003, 750-489 shall only be supplied with 750-606 or 750-625/000-001.

For Models 0750-0439/0040-0000, 0750-0481/0040-0000, 0750-0484/0040-0000, 0750-0486/0040-0000, 0750-0535/0040-0000, 0750-0585/0040-0000, 0750-0586/0040-0000, and 0750-0633/0040-0000: Shall only be operated with a power supply 24 Vdc Diagnosis for Ex I XTR Modules 0750-0606/0040-0000

For head stations containing SD card reader sockets only:

English	French
WARNING: DO NOT CONNECT OR DISCONNECT SD-CARD WHILE CIRCUIT IS LIVE UNLESS THE AREA IS KNOWN TO BE FREE OF IGNITABLE CONCENTRATIONS OF FLAMMABLE GASES OR VAPORS.	AVERTISSEMENT: NE PAS BRANCHER NI DÉBRANCHER <i>SD-CARD</i> PENDANT QUE LE CIRCUIT EST SOUS TENSION À MOINS QUE L'EMPLACEMENT NE SOIT EXEMPT DE CONCENTRATIONS INFLAMMABLES.

For devices with Ether CAT/Ethernet connectors:

Only for use in LAN, not for connection to telecommunication circuits.

For the following modules:

750-8212/040-000, 750-8212/040-001, 750-8216/040-000, 750-8216/040-001 the max. ambient temperature for vertical mounting positions (Modules are vertically piled above each other) is 65 °C.

For Couplers/Controllers and Economy bus modules only:

The configuration interface Service connector is for temporary connection only. Do not connect or disconnect unless the area is known to be non-hazardous. Connection or disconnection in an explosive atmosphere could result in an explosion.

For devices containing fuses:

English	French
WARNING - DEVICES CONTAINING FUSES MUST NOT BE FITTED INTO CIRCUITS SUBJECT TO OVERLOADS, E.G. MOTOR CIRCUITS	ATTENTION – DES APPAREILS AVEC FUSIBLES NE DOIVENT PAS ÊTRE INTÉGRÉS DANS DES CIRCUITS QUI SONT SOUMIS À UNE SURCHARGE, PAR EX. DES CIRCUITS DE MOTEUR.

A switch suitable for the location where the equipment is installed shall be provided to remove the power from the fuse.

10.1.2.7 UL Hazardous Locations per Report Reference E198726-2023-01-31

Because the following information refers to language-specific regulations, standards or certifications applicable to the specific installation and operation location, it is presented in the respective original language.

Installation and operating instructions Issued on 2023-01-31

This equipment is suitable for use in Class I, Division 2, Groups A, B, C and D Or nonhazardous locations only.

This equipment is an OPEN-TYPE device meant to be installed in an enclosure (DIN rail mounted) suitable for the environment and that is only accessible with the use of a tool.

English	French
WARNING - EXPLOSION HAZARD - DO NOT DISCONNECT EQUIPMENT UNLESS POWER HAS BEEN SWITCHED OFF OR THE AREA IS FREE OF IGNITABLE CONCENTRATIONS.	AVERTISSEMENT - RISQUE D'EXPLOSION - NE DÉBRANCHER L'APPAREIL QU'EN L'ABSENCE DE COURANT OU QUE L'EMPLACEMENT NE SOIT EXEMPT DE CONCENTRATIONS INFLAMMABLES.

10.2 Protected Rights

- Adobe® and Acrobat® are registered trademarks of Adobe Systems Inc.
- Android™ is a trademark of Google LLC.
- Apple, the Apple logo, iPhone, iPad and iPod touch are registered trademarks of Apple Inc. registered in the USA and other countries. "App Store" is a service mark of Apple Inc.
- AS-Interface® is a registered trademark of the AS-International Association e.V.
- BACnet® is a registered trademark of the American Society of Heating, Refrigerating and Air Conditioning Engineers, Inc. (ASHRAE).
- *Bluetooth*® is a registered trademark of Bluetooth SIG, Inc.
- CiA® and CANopen® are registered trademarks of CAN in AUTOMATION – International Users and Manufacturers Group e.V.
- CODESYS is a registered trademark of CODESYS Development GmbH.
- DALI is a registered trademark of the Digital Illumination Interface Alliance (DiiA).
- Docker and the Docker logo are trademarks or registered trademarks of Docker, Inc. in the United States and/or other countries. Docker, Inc. and other parties may also have trademark rights in other terms used herein.
- EtherCAT® is a registered trademark and patented technology licensed by Beckhoff Automation GmbH, Germany.
- ETHERNET/IP™ is a registered trademark of the Open DeviceNet Vendor Association, Inc (ODVA).
- EnOcean® is a registered trademark of EnOcean GmbH.
- Google Play™ is a registered trademark of Google Inc.
- IO-Link is a registered trademark of PROFIBUS Nutzerorganisation e.V.
- KNX® is a registered trademark of the KNX Association cvba.
- Linux® is a registered trademark of Linus Torvalds.
- LON® is a registered trademark of the Echelon Corporation.
- Modbus® is a registered trademark of Schneider Electric, licensed for Modbus Organization, Inc.
- OPC UA is a registered trademark of the OPC Foundation.

- PROFIBUS® is a registered trademark of the PROFIBUS Nutzerorganisation e.V. (PNO).
- PROFINET® is a registered trademark of the PROFIBUS Nutzerorganisation e.V. (PNO).
- QR Code is a registered trademark of DENSO WAVE INCORPORATED.
- Subversion® is a trademark of the Apache Software Foundation.
- Windows® is a registered trademark of Microsoft Corporation.

10.3 Accessories

Table 9: Recommended Accessories

Item number	Item Description	Item Description
Communication Cable		
750-920	Communication Cable	4-pole male header – D-Sub 9 socket; 2.5 m
WAGO DIN-Rails		
210-1xx	DIN-rails	Steel bluish, galvanized, chromated; copper
Buffer Modules		
787 Series Capacitive Buffer Modules	See product catalog	
Shielding Elements		
790 Series Shield Connection System	See product catalog	
End Stops		
249-1xx	Screwless end stop	
Tools		
210-722	Operating tool set	Operating tool set with partially insulated shaft
Test Probes		
735-500	Test pin	1 mm diameter; 30 VAC / 60 VDC; CAT0; with solder connection for test cable
859-500	Test pin	1 mm diameter; 30 VAC / 60 VDC; CAT0; with solder connection for test cable
Coding Keys		
753-150	Coding Keys	753 Series Coding Keys
Marking System		
2009-145	Mini-WSB Inline	On reel; stretchable 5 ... 5.2 mm; plain; snap-on type

List of Tables

Table 1	Color coding of Component Types	18
Table 2	Color Coding of Component Classes.....	18
Table 3	Explanation of the Marking Example	19
Table 4	Explanation of the Example of Different Marking.....	20
Table 5	Production Number	21
Table 6	Update Matrix.....	21
Table 7	High-Isolation Filter Modules	36
Table 8	Power Requirement: Example Calculation	43
Table 9	Recommended Accessories	62

List of Figures

Figure 1	Example Head Station Housings	12
Figure 2	Example I/O Module Housings	12
Figure 3	Beispielansicht PFC	13
Figure 4	Beispielansicht Controller	14
Figure 5	750 Series I/O Module with CAGE CLAMP® Connections (Example)	15
Figure 6	750 Series I/O Module with Push-in CAGE CLAMP® Connections (Example)	16
Figure 7	753 Series I/O Module (Example)	17
Figure 8	Data Contacts	22
Figure 9	Example of Power Jumper Contact Arrangement (Left: Blade Contacts; Right: Spring Contacts)	22
Figure 10	Potentials of the Power Jumper Contacts	23
Figure 11	DIN-Rail Contact (example)	23
Figure 12	Illustration of the Various Potential Groups	24
Figure 13	Supplying System Power (Example)	25
Figure 14	Field Supply Infeed (Example)	26
Figure 15	Installation Clearances	31
Figure 16	Coordinate model: width (x), height (y), depth (z)	32
Figure 17	Power Supply Concept for Marine Applications – Classes A and B	36
Figure 18	Power Supply Concept for Marine Applications – Classes A and B with FE Power Jumper Contact	37
Figure 19	Ex i Power Supply Concept	38
Figure 20	Power Supply Concept for Marine Applications in Ex i Zone – Class A	40
Figure 21	Power Supply Concept for Marine Applications in Ex i Zone – Class B	41
Figure 22	Power Supply Concept Example with F I/O-Modules	42
Figure 23	Locking the Head Station	47
Figure 24	Inserting the I/O Module	47
Figure 25	Snapping the I/O Module On	48
Figure 26	753 Series Wiring Interface and I/O Module	48
Figure 27	Disengage the locking cam	49
Figure 28	Pulling the Release Tab	50
Figure 29	Pulling the Locking Latch	50
Figure 30	Detaching the 753 Series I/O Module	51
Figure 31	Putting the Coding Keys Together	51
Figure 32	Inserting Coding Keys	52
Figure 33	Plugging the Connector into Place	52
Figure 34	Coding Keys for Clear Assignment	52
Figure 35	Connecting a Conductor to a CAGE CLAMP®	53

Figure 36	Connecting Conductor to Push-in CAGE CLAMP®	54
-----------	---	----

WAGO GmbH & Co. KG

Postfach 2880 · D - 32385 Minden
Hansastraße 27 · D - 32423 Minden

✉ info@wago.com

🌐 www.wago.com

Headquarters	+49 571/887 – 0
Sales	+49 (0) 571/887 – 44 222
Order Service	+49 (0) 571/887 – 44 333
Fax	+49 571/887 – 844169

WAGO is a registered trademark of WAGO Verwaltungsgesellschaft mbH.

Copyright – WAGO GmbH & Co. KG – All rights reserved. The content and structure of the WAGO websites, catalogs, videos and other WAGO media are subject to copyright. Distribution or modification of the contents of these pages and videos is prohibited. Furthermore, the content may neither be copied nor made available to third parties for commercial purposes. Also subject to copyright are the images and videos that were made available to WAGO GmbH & Co. KG by third parties.